

















# TIJDSCHRIFT VOOR ENTOMOLOGIE

UITGEGEVEN DOOR

DE NEDERLANDSE ENTOMOLOGISCHE VERENIGING





# NEDERLANDSE ENTOMOLOGISCHE VERENIGING

## BESTUUR (BOARD)

Voorzitter (Chairman) . . . . .	C. A. W. Jeekel
Vice-voorzitter (Vice-President) . . . . .	L. H. M. Blommers
Secretaris (Secretary) . . . . .	R. de Jong
<i>Address</i> . . . . .	<i>Rijksmuseum van Natuurlijke Historie, Raamsteeg 2, Leiden 2311 PL</i>
1e Penningmeester (Treasurer I) . . . . .	L. P. S. van der Geest
<i>Address</i> . . . . .	<i>Doornenburg 9, Landsmeer 1211 GP</i>
2e Penningmeester (Treasurer II) . . . . .	P. Oosterbroek
<i>Address</i> . . . . .	<i>Baanstraat 2, Edam 1135 CB</i>
Bibliothecaris (Librarian) . . . . .	W. N. Ellis
<i>Address</i> . . . . .	<i>Plantage Middenlaan 64, Amsterdam 1018 DH</i>
Lid (Member) . . . . .	B. van Aartsen

## TIJDSCHRIFT VOOR ENTOMOLOGIE

Redactie (Editorial Board) . . . . .	P. J. van Helsdingen, R. de Jong, J. Krikken, C. van Achterberg, S. A. Ulenberg, J. van Tol
<i>Address</i> . . . . .	<i>Rijksmuseum van Natuurlijke Historie, Raamsteeg 2, Leiden 2311 PL</i>

The journal serves the publication of papers on Insecta, Myriapoda and Arachnoidea.  
Subscription rate: D.Fl. 300,— per year.

Issues 1—4 appeared on 20.XII.1985

ISSN 0040-7496

## INHOUD

Cobben, R. H. — Additions to the Eurasian saldid fauna, with a description of fourteen new species (Heteroptera, Saldidae) .....	215
Jong, M. R. de. — Taxonomy and biogeography of Oriental Prasiini 1: the genus <i>Prasia</i> Stål, 1863 (Homoptera, Tibicinidae) .....	165
Nieukerken, E. J. van. — A taxonomic revision of the Western Palaearctic species of the subgenera <i>Zimmermannia</i> Hering and <i>Ectoedemia</i> Busck s. str. (Lepidoptera, Nepticulidae), with notes on their phylogeny .....	1
Roskam, J. C. — Evolutionary patterns in gall midge — host plant associations (Diptera, Cecidomyiidae) .....	193





# TIJDSCHRIFT VOOR ENTOMOLOGIE

UITGEGEVEN DOOR

DE NEDERLANDSE ENTOMOLOGISCHE VERENIGING



## INHOUD

E. J. VAN NIEUKERKEN. — A taxonomic revision of the Western Palaearctic species of the subgenera *Zimmermannia* Hering and *Ectoedemia* Busck s.str. (Lepidoptera, Nepticulidae), with notes on their phylogeny, pp. 1—164, figs. 1—549.





# A TAXONOMIC REVISION OF THE WESTERN PALAEARCTIC SPECIES OF THE SUBGENERA *ZIMMERMANNIA* HERING AND *ECTOEDEMA* BUSCK S.STR. (LEPIDOPTERA, NEPTICULIDAE), WITH NOTES ON THEIR PHYLOGENY

by

ERIK J. VAN NIEUKERKEN

*Department of Animal Systematics and Zoogeography, Vrije Universiteit, Amsterdam, Netherlands*

## ABSTRACT

The subgenera *Zimmermannia* Hering and *Ectoedemia* s.str., together forming the genus *Ectoedemia* Busck sensu Wilkinson & Newton (1981) are described and redefined, and the Western Palaearctic species are revised. In total 50 species are recognised, including the new species *hispanica*, *monemvasiae*, *nuristanica* in *Zimmermannia* and *andalusiae*, *algeriensis*, *leucothorax*, *almifoliae*, *contorta* and two unnamed species in *Ectoedemia* s.str.

Fifteen new synonymies and ten new combinations are established and 42 lectotypes are designated. Primary types have been examined in many cases. Data on larvae and biology are included and keys to all species are provided.

The monophyly and the sister group relationships of both subgenera are demonstrated. The subgenus *Ectoedemia* can be divided into the *populella* group, *suberis* group, *subbimaculella* group and *occultella* group, being monophyletic entities, and the possibly paraphyletic *angulifasciella* group. Two alternative hypotheses of the phylogeny within *Ectoedemia* s.str. are presented.

Decisions on species discrimination have in many cases been corroborated by study of allozymes.

## CONTENTS

Abstract .....	1	Acknowledgements .....	92
Introduction .....	1	References .....	92
Methods .....	2	Index to (sub)genera and species treated .....	98
Morphology .....	5	INTRODUCTION	
Taxonomic treatment .....	8	The present revision deals with the 50 Western Palaearctic species of <i>Ectoedemia</i> Busck, 1907, here assigned to the subgenera <i>Zimmermannia</i> Hering and <i>Ectoedemia</i> s.str. These two form the genus <i>Ectoedemia</i> in the sense of Wilkinson & Scoble (1979) and Wilkinson & Newton (1981). The concept of <i>Ectoedemia</i> was recently enlarged by Scoble (1983) to contain the subgenera <i>Fomoria</i> Beirne and <i>Laqueus</i> Scoble, and one more subgenus will be included in a forthcoming generic revision of Holarctic Nepticulidae (Van Nieukerken, in preparation). An up-to-date survey of the Western Palaearctic species assigned to the subgenera of <i>Ectoedemia</i> not treated here, will be presented by Van Nieukerken (in press).	
Checklist of species treated .....	8	Throughout this work the name <i>Ectoedemia</i> alone is reserved for the combination of the two	
Keys to the Western Palaearctic species of <i>Ectoedemia</i> , subgenera <i>Zimmermannia</i> and <i>Ectoedemia</i> s.str. ....	9		
Subgenus <i>Zimmermannia</i> .....	17		
Subgenus <i>Ectoedemia</i> .....	27		
The <i>populella</i> group .....	28		
The <i>preisseckeri</i> group .....	37		
The <i>suberis</i> group .....	38		
The <i>subbimaculella</i> group .....	43		
The <i>terebinthivora</i> group .....	63		
The <i>angulifasciella</i> group .....	63		
The <i>occultella</i> group .....	78		
Names of doubtful status, probably belonging to <i>Ectoedemia</i> .....	82		
Catalogue of Hostplants of Western Palaearctic <i>Ectoedemia</i> .....	82		
Phylogeny .....	85		
Biogeography .....	91		



subgenera treated here, *Ectoedemia* s.str. is the typical subgenus and *Ectoedemia* s.l. is the enlarged genus in the concept of Van Nieuwerkerken (in press).

For a taxonomic history of the genus and description of the Nearctic species refer to Wilkinson & Scoble (1979) and Wilkinson & Newton (1981). The three South-African species have been described by Scoble (1978, 1979).

A complete revision of the known *Ectoedemia* species in the Western Palaearctic region has not been carried out previously. The last author reviewing all European species was Meess (1910) who assigned most species to *Nepticula* Heyden (= *Stigmella* Schrank). Of the 138 species in his work only 19 belong to *Ectoedemia* in the present sense, of which 15 are here recognised as good species, hence the number of species has since been more than tripled.

In Europe Petersen (1930) figured the male genitalia of some nepticulid species for the first time, but retained them in the large genus *Nepticula*. Beirne (1945), who divided the Nepticulidae into several genera on the basis of the male genitalia of the British species, erected the genus *Dechthiria* for the leafmining species here assigned to *Ectoedemia* s.str.

Hering (1940) erected *Zimmermannia* as a genus for the barkminers, but most European authors placed them in *Ectoedemia*, following Busck, as did Klimesch (1953) in his revision of the four known European species.

Svensson (1966) was the first to discover the similarity between *Ectoedemia* and *Dechthiria* and hence synonymised both. This was followed by Borkowski (1972) and Emmet (1976) in their local fauna works. These authors recognised *Dechthiria* and *Zimmermannia* as separate subgenera, but Wilkinson & Newton (1981) treated them as synonyms of *Ectoedemia*. *Zimmermannia* is here re-established as subgenus for reasons to be discussed.

Apart from the four species treated by Klimesch (1953), no part of the genus has been completely revised and published in Europe previously.

Most species described since Meess (1910) were assigned originally to *Nepticula* or *Stigmella*, but several have in recent years been recombined with *Ectoedemia* or *Trifurcula* s.l., although frequently only in faunistic lists, without any comments. Most names given to European nepticulid species have been assigned to their correct genus in my checklist (Van Nieuwerkerken, in press), but a few doubtful names

still exist. Two are treated at the end of this paper.

For those species, likely to be included in *Ectoedemia*, primary types were studied as far as possible. A few old types were either not available during this study or could not be traced. In most cases however, there has been enough proof of their status. For some recently described species, no types have been studied, because detailed description and figures of genitalia made it unnecessary. A large wealth of material from several museums, private collections and our own collection has been studied and resulted in the discovery of eight undescribed species, and much new distribution data.

However, knowledge of *Ectoedemia* species in the Mediterranean region and Middle East is still poor and based on scanty data, as can be inferred from the distribution maps. For instance none of the autumn-feeding species of the *angulifasciella* group are recorded from Spain, probably because autumn-mines have not yet been collected.

For all species, including those recently described, complete (re)descriptions are provided. For most species the female genitalia are described here for the first time. These often appear to give better diagnostic characters than the male genitalia in this genus.

Because of limitations in time and space, I have refrained from giving detailed descriptions of larvae, although much material was available. However, it is hoped that a full treatment of the larvae can be made later.

Concise biological data have been provided, based on own observations, unless otherwise stated.

A discussion of the phylogeny of the genus, using cladistic methods, concludes this revision.

## METHODS

### Preparation of genitalia

Genitalia slides were prepared following Robinson (1976), but adapted slightly for the Nepticulidae. The abdomens were macerated in 10% KOH heated in a waterbath of 90 °C for 10–15 minutes. After preliminary rinsing and cleaning they were stored overnight in ethanol 70%. Cleaning appeared to be much easier after treatment with ethanol and there were no disadvantages. Cleaning and removal of scales was carried out with a snipe-feather primary or a pointed piece of stiff paper. For dissecting minute-pins were mounted in handles.

Male genitalia were usually stained red with haemalun and females either with haemalun or chlorazol black E.

Dissecting was usually done in glycerin to prevent floating. Male genitalia were removed from the abdomen, the aedeagus was taken out in some specimens of each species, by perforating the membranes holding it to the valvae and capsule; in *Ectoedemia* this is often difficult because of the tight connections to the aedeagal carinae. It is therefore advisable not to remove the aedeagus from all specimens, otherwise their in-situ connections can not be studied. Hooking out the vesica is possible in the larger species, but usually impracticable in smaller ones. Female genitalia were removed by separating segment 7 to 9 with the internal genitalia from the abdomen. Before mounting, genitalia were examined in glycerin in order to study their three-dimensional structure and to make figures in various aspects.

After dehydration the genitalia were embedded in euparal, and arranged in their desired position. The euparal was placed in a thin layer so that the parts could not move and the slide was then dried in an oven overnight. Thereafter a small drop of euparal was added and the coverslip positioned with, if necessary, euparal essence. This method prevents the parts from becoming displaced and disorientated. Care must however be taken not to damage protruding parts such as the gnathos or uncus with the coverslip. Male genitalia were mounted ventral side up, female genitalia either with ventral or dorsal side. In order to study the female postabdomen embedding with dorsal side up is most desirable.

In the above described method the genitalia are not squashed, which has a disadvantage in that focussing for photography is difficult, but this is outweighed by the disadvantage of distortion by squashing. It has unfortunately proved to be virtually impossible to unroll the male genitalia in the way practiced for *Incurvarioidea* (see Nielsen, 1980), because of the strongly sclerotised capsule, the tightly fused valvae, and the small size of the genitalia.

### Figures

Drawings of genitalia were made with a Zeiss universal microscope and camera lucida attachment both from permanent slides and genitalia in glycerin. Dorsal aspects of valvae were drawn from ventrally mounted specimens, thus repre-

senting in fact a mirror image of the right valva as seen through the valva. From the transtilla only one half is figured. Setae are often represented in drawings by their sockets only because they are often broken in slides. In the figures of aedeagi in *Ectoedemia* s.str. the vesica is omitted.

The practice of illustrating complete genitalia in taxonomic papers on Lepidoptera is not followed, since such figures are usually too complicated to show the diagnostic features unambiguously. Therefore the most characteristic parts of the genitalia are separately figured and presented in a comparative way. However, to give an overall impression of the genitalia, photographs are also provided. These were prepared with a Zeiss universal photo-microscope, using bright-field contrast.

SEM micrographs were taken with an ISI 40 Scanning electron microscope, using a beam current of 10kV. Specimens were air-dried, mounted on stubs and gold-coated.

Adults were photographed with a Zeiss Tessovar camera, using black velvet as background, and concealed lighting, thus reducing reflections to a minimum. Photographs of mines in dried leaves were taken with a reproduction camera and transmitted light.

### Measurements

Forewing length was measured only when flat from wing base to tip of fringe, using an ocular-micrometer in a Wild M5 stereomicroscope at a magnification of 25. Forewing length is preferred to the less accurate wingspan measurement, but for reasons of comparability with other authors the latter figure is added too.

Genitalia were measured using a Zeiss universal research microscope with ocular-micrometer, either with objective 6.3 × (bursa length and signa if very long) or 16 × (other measurements). Capsule length was measured along mid-line from tip of tegumen to anterior margin of ventral plate of vinculum, exactly in middle of anterior concavity, thus excluding lateral projections of vinculum. Valva length was measured from tip to anteriormost extension of ventral surface, thus excluding the transtilla. Aedeagus length was measured including carinal processes.

The bursa length could only be measured very roughly, approximately from point of entrance of ductus spermathecae to anterior tip. Measurements of signa are self-evident.



From all species measurement range is given first, followed by mean, standard deviation and sample-size in brackets.

Mean and standard deviations are only calculated for a sample-size of five and larger. An individual of extreme size falling far outside the normal range is given in brackets. Wing measurements of extremely small specimens, probably caused by food-shortage, are excluded. Not too much statistical significance should be given to these figures, because the samples were not selected statistically, and sometimes individuals only belong to one population.

### Material

A considerable part of the adult material was reared in our laboratory, and will be mainly transferred to the collection of ZMA, however some specimens will be distributed to other museums. In addition material of many collections, listed below, has been examined. The material is listed at the end of each description in alphabetical order of localities, arranged in an alphabetical list of countries. When a number of consecutive data in one country is based on material from one collection, the abbreviation of this collection is only given at the end of these data. Primary types, cited under the species headings are included in material examined again, when actually studied.

Locality names are spelled as far as possible according to *The Times Atlas of the World* (Comprehensive Edition, 1975), a deviating name on a label is given in brackets.

A particular problem form the locality-names on the labels of C. Chrétien, who often used abbreviations of small hamlets or local names, which can not even be traced on topographical maps. By courtesy of G. Luquet, who prepared a list of Départements visited by Chrétien in various years, it has been possible to locate some of these obscure places. «Antarv.» has not been traced, but the collecting dates suggest that this is near Digne. «Nesp.» is an abbreviation of Nespouls, but most likely not of the village of that name in Corrèze. From a combination with "Artén." (= montagne d'Arténac) and the collecting year on certain labels it is inferred to be probably near St. Pons (Hérault).

Countries are used with their present-day political boundaries, but for convenience East-Germany comprises here both the German Democratic Republic and Berlin.

Distribution maps are prepared on the base of material examined and reliable literature re-

cords. When a certain literature record was far beyond the known range, and its correctness could not otherwise be proved it has been excluded. Many additional data were received by courtesy of R. Buvat, R. Johansson, O. Karsholt, J. Klimesch, J. Kyrki and S. E. Whitebread. A list of literature used in compiling the maps will be given later.

The data on biology are for a considerable part based on own observations, supplemented by literature data. Unless otherwise stated, mines have been collected between 1978 and 1984 by me or my colleagues or students, chiefly C. J. M. Alders, J. J. Boomsma, G. Bryan, B. J. van Cronenburg, H. van Driel, S. B. J. Menken, J. W. Schöorl, and stored in our collection. Larvae have been examined living, and are partly also stored in alcohol in our collection.

Nomenclature of hostplants follows Tutin et al. (1964, 1968). Some abbreviations used are: a.l. = at light, e.l. = ex larva, S = sternite, T = tergite.

### List of collections from which material has been studied

Institutions and Museums: BMNH, British Museum (Natural History), London, U.K.; ETHZ, Eidgenössische Technische Hochschule, Entomologisches Institut, Zürich, Switzerland; IPAK, Institute of the Polish Academy of Sciences, Krakow, Poland; IRSN, Institute Royal des Sciences naturelles, Bruxelles, Belgium; LNK, Landessammlungen für Naturkunde, Karlsruhe, West Germany; MCST, Museo Civico di Storia Naturale, Terrasini, Italy; MHUB, Museum für Naturkunde der Humboldt-Universität, Berlin, East Germany; MNHN, Muséum national d'Histoire naturelle, Paris, France; MRST, Museo Regionale di Scienze Naturali, Torino, Italy; NMW, Naturhistorisches Museum, Wien, Austria; RMNH, Rijksmuseum van Natuurlijke Historie, Leiden, Netherlands; RMS, Riksmuseum Stockholm, Sweden; SMNS, Staatliches Museum für Naturkunde, Stuttgart, West Germany; TMAB, Természettudományi Múzeum, Állatára, Budapest, Hungary; UMZC, University Museum of Zoology, Cambridge, U.K.; USNM, United States Natural History Museum, Smithsonian Institution, Washington D.C., U.S.A.; ZIAS, Zoological Institute, Academy of Sciences, Leningrad, USSR; ZMA, Instituut voor Taxonomische Zoologie (Zoologisch Museum), Amsterdam, Netherlands; ZMC, Zoologisk Museum, Universitet, København, Denmark;

ZSM, Zoologische Staatssammlung, München, West Germany; ZSMK, idem, collection Klimesch, Linz, Austria.

Private collections: AFW, coll. Van Frankenhuyzen, Wageningen, Netherlands; coll. Buvat, Marseille, France; coll. Derra, Bamberg, West Germany; ETO, coll. Traugott-Olsen, Marbella, Spain; EvN, coll. Van Nieuwerkerken, Leiden, Netherlands; coll. Gielis, Lexmond, Netherlands; coll. Huisman, Melissant, Netherlands; coll. Johansson, Växjö, Sweden; coll. Koster, Callantssoog, Netherlands; coll. Kuchlein, Wageningen, Netherlands; coll. Leraut, Paris, France; coll. Speidel, Karlsruhe, West Germany; coll. Wolschrijn, Apeldoorn, Netherlands.

### MORPHOLOGY

The following discussion is mainly intended to review those characteristics which are important for understanding the phylogeny of *Ectoedemia* and those which are useful as diagnostic features. Exhaustive treatments of the adult morphology of *Ectoedemia* and the Nepticulidae are given by Scoble (1979 and 1983), and of the larval morphology by Gustafsson (1981a) and Van Nieuwerkerken & Jansen (in preparation). Schönherr (1958) provides an excellent monograph of the species *E. liebwerdella*.

Head (fig. 15).

The piliform scales on frons and vertex are collectively treated as the frontal tuft, the colour of which is often diagnostic, although some local and geographical variation occurs in several species. In *Ectoedemia* the collar is invariably composed of piliform scales, in contrast to *Stigmella* where the scales are lamellar. Its colour is often different from the frontal tuft. The term collar, although descriptive, might be misleading, since these groups of scales, inserted posterior of the eyes, are not homologous with the collar of higher Ditrysia, which is a prothoracic structure.

The number of antennal segments has some diagnostic value, although it varies within a species and sex, males have always more segments than females of the same species. There is also a positive correlation between individual size and number of antennal segments. Scape and pedicel are usually paler than the flagel, except in *E. intimella*. For a detailed description of antennal morphology see Van Nieuwerkerken & Dop (in preparation).

The mouthparts of the species treated do not

show diagnostic features. The eyes show the typical lepidopteran corneal nipple array pattern (fig. 16) (Davis, 1978).

Thorax and wings.

The thorax itself does not present many characteristics, the colour of the scales on mesoscutum and tegulae is sometimes diagnostic, but in many species it is concolorous with the forewings.

The colour-pattern and colour of the forewings is one of the most remarkable diagnostic features, although it is only useful in undamaged specimens, and many closely related species have the same or a similar colour-pattern.

Most species of *Ectoedemia* s.str. have white wing markings, often in the form of a medial fascia, or opposite costal and dorsal spots. In addition basal and discal spots may occur. It is often difficult to distinguish between metallic and non-metallic fasciae and spots. Comparisons should therefore be made with species in which this state is known. Several species, especially in *Zimmermannia*, have the forewings uniformly ochreous irrorate with brown, fuscous or similar tinges. In all but a few species the cilia are light and separated from the darker part of the forewing by a line formed by the tips of the last row of lamellar scales, this line is termed here the cilia-line. The scaling of the forewing is invariably rough, the scales (figs. 25, 26) are of the normal advanced lepidopteran type (Kristensen, 1970; Davis, 1978).

The hindwing of the males frequently possesses diagnostic secondary sexual characters. A frenulum is always present, in addition several species mining *Quercus* have a row of costal bristles. Most other species however bear a brush of hair-scales instead, arising near the frenulum, which is believed to be homologous with the costal bristles. Following Scoble (1983) it is named here hair-pencil. In rest it is laid parallel to the main-axis of the hindwing, in a shallow groove, which is especially prominent in several *E. (Zimmermannia)* species (figs. 10—14, 21—24). The hair-pencil can be spread out, and probably plays an important role in courtship, as Schönherr (1958) has shown for *E. liebwerdella* (see his figs. 26 and 41). The hair-pencil is often surrounded by lamellar scales which are differently coloured from the rest of the hindwing, these scales are referred to as special or androconial scales (figs. 18—20). The fine structure differs from the normal wing scales. In some species they occupy almost the



complete dorsal surface of the hindwing, as in *terebinthivora* or *heringella* (figs. 53, 62). Colour of these scales and the hair-pencil is very diagnostic. In *E. (Zimmermannia)* and to a lesser extent in some other species, the shape of the hindwing is influenced by the presence of the hair-pencil: the costal margin is abruptly emarginated and curved inwards beyond the pencil and there is often a prominent humeral lobe (figs. 8, 10—19).

In several species the males possess in addition to the hindwing characteristics, specialisations on the underside of the forewing, such as a patch of differently coloured, androconial scales (figs. 63, 86). Species with a hair-pencil often have a scaleless area on the forewing under surface, probably in rest contacting the hair-pencil.

Females always bear a row of costal bristles, and lack any additional sexual characters.

The venation of *Ectoedemia* (figs. 8, 9) is very uniform, with only slight non-diagnostic variation in length and tracheation of some veins. The venation is essentially similar to that in the taxa *Fomoria* Beirne and *Etainia* Beirne.

#### Abdomen.

The scaling of the abdomen is uniform, and although there is some interspecific variation, the colour has not been found to be diagnostic. The anterior part of sternite 2 (see Kristensen & Nielsen, 1980) has a triangular shape. The male bears a pair of anal tufts on tergite 8. The external shape of the female ovipositor is sometimes diagnostic, especially when it is pointed, such as in *E. turbidella* or *agrimoniae*.

#### Male genitalia (figs. 3, 4, 27, 28).

The male genitalia of the species under study show a remarkable uniformity when compared to other nepticulid genera, in several cases they do not even provide characters to distinguish between species.

It must be stressed here that slight differences which appear from the illustrations often depend on the way of mounting the slides. A slight deviation from the ventral view can change the shape of the vinculum for instance, and since most structures are hinged by membranes to each other, mutual changes in position occur easily. This is especially the case with the gnathos. It is therefore advisable to study the genitalia in fluid (glycerin) before mounting permanently, and squashing should be avoided.

The vinculum forms a complete strongly sclerotised ring and is invisibly fused with the tegu-

men; together they are termed the capsule. The ventral plate of the vinculum is always short, and slightly concave anteriorly; the ventral plate can be divided by the ring, formed by the attachment to segment 8, in an anterior part, which is situated within the abdomen, and a posterior part, covered with scales. The anterior part has in the past erroneously been referred to as the saccus (Beirne, 1945; Wilkinson & Newton, 1981).

The tegumen is posteriorly produced into a pseuduncus, which can be approximately triangular, rounded, truncate or pointed. It is covered with many tactile hairs and scales.

The uncus is absent, it has been believed (cf Beirne, 1945) that it is membranous, but the membranous structure which is present between gnathos and tegumen is in my opinion formed by the anal tube only.

The gnathos is strongly sclerotised, and essentially composed of two lateral arms and a more ventral central element, which projects posteriorly and is more or less tongue-shaped. The form of the central element is highly diagnostic, but it must be viewed at the correct angle. In several species of *Ectoedemia* s.str. the central element is in fact divided in two parts: a basal ventral part, fused to the lateral arms and distally ending with a serrate margin, and a more distal, tongue-shaped element which is inserted dorsal to the basal part and connected by less sclerotised tissue. In lateral view the division is clearly seen, but in ventral view this is less obvious. The lateral arms of the gnathos are hinged by membranes to the lateral arms of the vinculum.

The valva is roughly triangular in ventral view, with an often inwardly directed tip. It is essentially a hollow sac, which is open at the anterior end. On the ventral and outer (lateral) surface, the valva is covered with many setae and scales, whilst the inner and dorsal surfaces bear comparatively few setae, which however become more abundant towards the tip. Although it has been the practice in Nepticulidae to illustrate only the ventral surface of the valva, the dorsal surface offers more diagnostic detail and so is here illustrated as seen through ventrally mounted genitalia — thus viewing through the valva. Therefore it has not been necessary to spread or remove the valva. Ventrally the valvae are hinged to each other and the vinculum by membranes, dorsally they are tightly fused by the transtillae, which are considered to be a part of the valvae. In *Ectoedemia*

the transtilla always possess a well sclerotised horizontal bar and ventral arms. The length of the ventral arms varies within the species and therefore has a limited diagnostic value.

The aedeagus bears apically paired carinae, except in *E. spiraeae*. These have been incorrectly referred to as the juxta by Beirne (1945), see also Scoble (1983) for a discussion of aedeagal structures. Most *Ectoedemia* s.str. species have one pair of ventral carinae only, they are usually pointed and often divided in two or more processes. Additional spines occur in some species near the base of the carinae (fig. 28). Some species have a dorsolateral pair of carinae in addition, and most *E. (Zimmermannia)* species possess three pairs of carinae. The ventral carinae are hinged by a slightly sclerotised ventral process to the vinculum and by membranes to the valvae. Although the ventral process is always present, it has not been illustrated here in all species. Dorsal and lateral carinae are hinged by membranes to the valvae and transtilla. In *E. (Zimmermannia)* the large ventral carinae are tightly connected with the valvae, which have a fold on the inner surface in which the carinae fit. Probably for this reason the carinae in this group have sometimes been misinterpreted as parts of the valva. The membranes fusing the aedeagus to the rest of the genitalia tolerate only a small posterior movement of the aedeagus, hence in the everted position the carinae are folded back.

The aedeagus is often slightly asymmetric, such that it is longer at the right side, and often the two carinae of one pair differ slightly. An exceptional case is *klimeschi*, which has a highly asymmetrical aedeagus. The ejaculatory duct enters the aedeagus through an approximately circular opening on the ventral side, below the middle. Posterior to this opening a group of microsetae (setal pores) can be observed. The vesica is typically covered with numerous small spine-like cornuti, and only occasionally additional larger spines and other sclerotisations occur.

Female genitalia (figs. 6, 7, 30—34).

The female genitalia of Nepticulidae have been paid much less attention to than those of the male, since they were often thought of lesser diagnostic value. In fact in *Ectoedemia* they often provide better characteristics than the male genitalia. However, the weak sclerotisation and the greater individual variation — compared with males — make study and interpretation

more difficult. Several structures, which have not been used before, are found in this study to have high diagnostic value.

The only earlier complete and correct interpretation of the terminal segments is that of Dugdale (1974), see also the comments in Van Nieukerken (1983). Segment 7 is the last complete and more or less unmodified segment, which ventrally reaches the tip of the abdomen. The tip of sternite 7 is covered with many setae, probably mostly tactile. Dorsally tergite 7 encircles segments 8 and 9. Segment 8 comprises a distinct tergite, which is often approximately rectangular, and the complex anterior apophyses. They are dorsally united by tergite 8 and posteriorly by a semi-circular or angular, sclerotised bar, which is interpreted as sternite 8. The latter is covered by a membrane bearing many minute spines (fig. 30) and forms usually the tip of the abdomen and "ovipositor".

It is not completely clear if the integument covering tergite 8 belongs to that segment or is formed by segment 7, the latter possibility is suggested by the fact that the border between tergites 7 and 8 is often not clear. For practical reasons, however, setae and scales which in dorsal view appear to occur on tergite 8 are described as belonging to that segment. The posterior part of tergites 7 and 8 bear several sensory structures. Principally there are two lateral patches of scales and setae on tergite 8, and often some setae on tergite 7 as well, which is further covered with scales. In several species the scales on 8 are reduced and the number and size of setae increased, often forming distinct patterns or rows. Especially in species mining bark and evergreen *Quercus* there are large groups of long setae on these segments (figs. 31—34), which probably function in localising suitable oviposition sites. It is not clear if these setae are all mechanoreceptors only, or if these are partly chemoreceptors as well. In *E. caradjai* and *E. monemvasiae* the long setae are pectinate (fig. 32), in other species examined they are smooth. Segment 9 comprises a distinct tergite, often partly covered by tergite 8, with two distinct patches of setae (anal papillae) and the posterior apophyses. These end in indistinctly sclerotised internal structures, which probably have a function in opening and closing the genital and anal openings. The region near tergite 9 is difficult to interpret since many membranous structures occur, it is therefore not clear if there is underneath the anal opening a structure which can be considered to be sternite 9.



The enlarged portion of the vagina is referred to as the vestibulum, this part has earlier been regarded as part of the ductus bursae (Scoble, 1983) and sometimes termed colliculum (Wilkinson & Scoble, 1979; Wilkinson & Newton, 1981). Here the term ductus bursae is reserved for the narrowed part anterior of the entrance of the ductus spermathecae.

The vestibulum bears in *E. (Zimmermannia)* some indistinct sclerotisations and in most *Ectoedemia* s.str. species a ring-shaped sclerite (fig. 419), which in analogy to the Eriocraniidae (Davis, 1978) is termed vaginal sclerite. In addition to this sclerite the vestibulum has dorsally an evaginated pouch which often bears many spicules (fig. 420). At the transition of the vestibulum and the ductus bursae there is often a patch of very closely packed pectinations, similar to those on the corpus bursae. The corpus bursae is typically covered with many of such pectinations, combs of small denticles, and a pair of reticulate signa. The cells of the signa are also covered by small denticles. Shape and size of the signa is often diagnostic, but there is considerable intraspecific variation. The ductus spermathecae comprises a strongly sclerotised internal canal, ending in a sclerotised vesicle, and a membranous external canal, both canals are spiraled. The number of convolutions of the spermathecal duct appears to be fairly constant within a species, and has therefore high diagnostic value. The most common condition is 2½–3 convolutions, but as many as 14 convolutions have been found. In counting the convolutions the vesicle must be excluded. A distinct spermathecal papilla is absent.

#### TAXONOMIC TREATMENT

##### *Ectoedemia* Busck, 1907

(subgenera *Zimmermannia* Hering and *Ectoedemia* s.str.)

#### Diagnosis.

The following combination of characters is diagnostic:

1. Collar comprising piliform scales.
2. Cilia-line usually distinct (except *occultella*-group).
3. Forewing with closed cell between R and M+Cu.
4. Hindwing with two-branched Rs+M.
5. Antenna with sensillum vesiculocladum reduced into an unbranched blisterlike structure (Van Nieuwerkerken & Dop, in preparation).
6. In ♀ only 1 sensillum vesiculocladum per

segment (Van Nieuwerkerken & Dop, in preparation).

#### 7. Uncus absent.

*Stigmella* species are easily separated by the collar with lamellar scales and the different venation and genitalia. *Acalyptis* (= *Niepeltia*) species can be separated by the almost straight R+M vein in the forewing, and the reduced closed cell, shifted towards the base. Externally *Acalyptis* species in Europe are not likely to be confused with *Ectoedemia* because they have different colour patterns. Only *A. minimella* (Rebel) resembles somewhat *E. gilvipennella* or *E. nigrosarsella*, but it is more yellow and has a yellow hair-pencil. *Trifurcula* species can always be recognised by the three branched condition of the Rs+M in the hindwing. In addition males can always be recognized by the three pairs of anal tufts and the "velvet patch" on the underside of the hindwing. For *Parafomoria* see Van Nieuwerkerken (1983). European *Ectoedemia* (*Etainia*) species have two fasciae, and the males possess a long dorsal apodeme on the valvae (see Scoble, 1983). *Bobemania* species can be separated by the absence of a closed cell in forewing and the presence of an uncus. *Ectoedemia* (*Fomoria*) and *E. (Laqueus)* are externally not separable from the subgenera treated here. They both possess an uncus, and have generally a different form of genitalia (Scoble, 1983). In addition *E. (Laqueus)* has an anal loop in the forewing.

#### Taxonomy.

Two subgenera are recognised here, viz. *Zimmermannia* Hering and *Ectoedemia* s.str. This division is re-established here, because both groups are characterised by many more apomorphies than they share, they have very different biologies, and species can easily be recognised as belonging to one of the subgenera. *Ectoedemia* s.str. can also be subdivided further, but then much fewer characters are available and monophyly is not easily demonstrated. These groups are merely treated as species-groups without formal taxonomic status. See further section on phylogeny.

#### CHECKLIST OF SPECIES TREATED

##### *Ectoedemia* Busck

##### Subgenus *Zimmermannia* Hering

1. *atrifrontella* (Stainton)
2. *liebwerdella* Zimmermann
3. *longicaudella* Klimesch  
*peiuii* (Nemes) syn. n.

4. *hispanica* sp. n.
5. *monemvasiae* sp. n.
6. *amani* Svensson
7. *nuristanica* sp. n.
8. *liguricella* Klimesch

Subgenus *Ectoedemia* Busck  
*Dechtiria* Beirne

*populella* group

9. *intimella* (Zeller)
10. *hannoverella* (Glitz)
11. *turbidella* (Zeller)  
*populialbae* (Hering)
12. *klimeschi* (Skala)  
*niculescui* (Nemes) syn. n.
13. *argyropeza* (Zeller)  
*simplicella* (Heinemann) syn. n.

*preisseckeri* group

14. *preisseckeri* (Klimesch)

*suberis* group

15. *caradjai* (Groschke)
16. spec. (specimen 1843)
17. *suberis* (Stainton) comb. n.  
*viridella* (Mendes) syn. n.
18. *andalusiae* sp. n.
19. *aegilopidella* (Klimesch) comb. n.

*subbimaculella* group

20. *quinquella* (Bedell)
21. *algeriensis* sp. n.
22. *gilvipennella* (Klimesch) comb. n.
23. *leucothorax* sp. n.
24. *haraldi* (Soffner)
25. *ilicis* (Mendes) comb. n.
26. *heringella* (Mariani) comb. n.
27. *alnifoliae* sp. n.
28. *nigrosarsella* (Klimesch)  
*albifasciella* complex (29—32)
29. *albifasciella* (Heinemann)
30. *cerris* (Zimmermann)  
*montissancti* (Skala) syn. n.
31. *pubescivora* (Weber) comb. n.
32. *contorta* sp. n.  
*subbimaculella* complex (33—36)
33. *subbimaculella* (Haworth)  
*nigrociliella* (Stephens) syn. n.
34. *heringi* (Toll)  
*quercifoliae* (Toll)  
*sativella* (Klimesch) syn. n.  
*zimmermanni* (Hering) syn. n.
35. *liechtensteini* (Zimmermann)

36. *phylotomella* (Klimesch) comb. n.
37. spec. (specimen 1375)

*terebinthivora* group

38. *terebinthivora* (Klimesch) comb. n.

“*angulifasciella* group”

39. *erythrogenella* (Joannis)
40. *spiraeae* Gregor & Povolný
41. *agrimoniae* (Frey)
42. *hexapetalae* (Szócs) comb. n.  
*angulifasciella* complex (43—46)
43. *angulifasciella* (Stainton)  
*schleichiella* (Frey) syn. n.  
*utensis* (Weber) syn. n.  
*minorella* (Zimmermann) syn. n.  
*? brunniella* (Saubert)
44. *atricollis* (Stainton)  
*aterrima* (Wocke)  
*staphyleae* (Zimmermann) syn. n.
45. *arcuatella* (Herrich-Schäffer)
46. *rubivora* (Wocke)
47. *spinosella* (Joannis)
48. *mahalebella* (Klimesch)

*occultella* group

49. *occultella* (Linnaeus)  
*strigilella* (Thunberg)  
*? mucidella* (Hübner)  
*mediofasciella* (Haworth) syn. n.  
*argentipedella* (Zeller)
50. *minimella* (Zetterstedt) comb. n.  
*mediofasciella* auct. nec Haworth  
*woolhopiella* (Stainton) syn. n.  
*viridicola* (Weber) syn. n.

KEYS TO THE WESTERN PALAEARCTIC SPECIES  
OF *ECTOEDEMIA* SUBGENERA *ZIMMERMANNIA*  
AND *ECTOEDEMIA* S.STR.

Based mainly on external characters<sup>1)</sup>

1. Forewings without distinct colour-pattern, irrorate or unicolorous, with at most inconspicuous group of white scales at tornus . . . 2
- Forewings with distinct white spot(s) or fascia . . . . . 12
2. Frontal tuft dark fuscous brown to black . . . . . 3
- Frontal tuft yellowish or orange, sometimes mixed with fuscous . . . . . 8
3. Thorax dorsally white with darker tips on

<sup>1)</sup> Two species mentioned in the text, but still undescribed have been excluded.

- mesoscutum and tegulae. ♂ with white hair-pencil . . . . . 1. *atrifrontella*
- Thorax dorsally brown with at most white tips on mesoscutum and tegulae . . . . . 4
4. ♂ hindwing without hair-pencil or costal emargination. ♀ with large patch of long tactile hairs on T7, extending almost to anterior margin. Occurring in Afghanistan . . . . . 7. *nuristanica*
- ♂ hindwing with hair-pencil and usually costal emargination. If ♀ with patch of long hairs, then only in posterior half of T7. Species occur in Europe or Anatolia . . . . . 5
5. Hair-pencil in ♂ short, about 1/4 hindwing length; without distinct costal emargination in hindwing. ♀ unknown . . . . . 4. *hispanica*
- Hair-pencil longer, at least 1/3 of hindwing length. Costal emargination conspicuous (figs. 10—14) . . . . . 6
6. Forewing with small tornal and costal white spots beyond middle, less conspicuous in ♂. Hair-pencil in ♂ white. Forewing scales almost uniformly dark . . . . . 2. *liebwerdella*
- Forewing with at most a tornal spot beyond middle. ♂ hair-pencil fuscous or yellowish brown. Scales darker at tips . . . . . 7
7. ♂ hair-pencil surrounded by brown scales. ♀ with large patch of approximately 100 very long tactile hairs on T7 and 8 (visible without dissection). Only known from Greece and Anatolia . . . . . 5. *monemvasiae*
- ♂ hair-pencil surrounded by white scales. ♀ with group of 20—30 long hairs, much shorter than in *monemvasiae*. Throughout Europe and Anatolia . . . . . 3. *longicaudella*
8. Large species, forewing length 3.0—4.5 mm. Cilia-line indistinct. Aedeagus with 2 or 3 pairs of carinae. ♀ genitalia without vaginal sclerite . . . . . 9
- Smaller species, forewing length 1.9—2.9 mm (rarely 3.0 mm). Cilia-line distinct. Aedeagus with one pair of carinae only. ♀ genitalia with vaginal sclerite . . . . . 10
9. Ground colour dark brown, irrorate with white. ♂ antennae with 36—41, ♀ with 36—37 segments. ♂ hindwing with hair-pencil and costal emargination . . . . . 6. *amani*
- Ground colour lighter, more yellowish brown, irrorate with white. ♂ antennae with 43—48, ♀ with 39—44 segments. ♂ hindwing without hair-pencil or costal emargination . . . . . 8. *liguricella*
10. Ground colour white, with scattered brown scales. ♂ with dark fuscous to black hair-pencil . . . . . 22. *gilvipennella*
- Ground colour brown to yellowish brown, mixed with yellowish white scales. ♂ without hair-pencil, but with costal bristles (♂ of *alnifoliae* unknown) . . . . . 11
11. Scape white, without brown scales. Forewing with many yellow scales between brown ones. ♀ ductus spermathecae with 13—14 convolutions. Larva feeds on deciduous *Quercus* in Europe . . . . . 28. *nigrosarsella*
- Scape white with some brown scales. Forewing mainly brown with few white scales. ♀ ductus spermathecae with 3 convolutions. Larva on *Quercus alnifolia* in Cyprus . . . . . 27. *alnifoliae* (♂ unknown)
12. Forewing with dorsal (tornal) spot only, but occasionally a few white scales along costa . . . . . 13
- Forewing with at least two light spots or fascia . . . . . 17
13. Dorsal spot postmedial in position . . . . . 14
- Dorsal spot medial in position . . . . . 15
14. Scape white, with brown scales . . . . . *E. (Fomoria) or Trifurcula* spp.
- Scape unicolorous white . . . . . see 2
15. Scales of forewing not significantly lighter at bases. Flagellum yellowish orange, similar to scape and pedicel. ♂ with hair-pencil, ♀ with pointed ovipositor . . . . . 9. *intimella*
- Scales of forewing distinctly lighter at base. Flagellum darker than scape and pedicel. ♂ with costal bristles, ♀ with blunt ovipositor . . . . . 16
16. Forewing with dorsal spot only. ♂ hindwing or forewing without androconial scales . . . . . 25. *ilicis*
- Forewing usually with some white scales along costa, opposite dorsal spot, but not forming distinct spot. ♂ hindwing upper-side and forewing underside with elongate patch of brown androconial scales . . . . . 26. *beringella*
17. Forewing with dorsal and costal distinctly postmedial in position . . . . . see 6, 2. *liebwerdella*
- Forewing with costal and dorsal spot medial or more basal, or fascia present . . . . . 18
18. Moth almost completely jet-black or greyish black, including cilia; cilia-line absent. Medial fascia present. Larva feeds on Betulaceae . . . . . 19
- Moth not completely black, usually with a fuscous or brownish tinge, cilia silvery white beyond distinct cilia-line. Larva feeds on other foodplants . . . . . 20
19. ♂ underside of forewing with small patch



- of narrow white scales (difficult to see, fig. 86). Hair-pencil white. ♀ frontal tuft yellow or yellowish orange. Aedeagus without long cornuti (fig. 405) . . . . . 49. *occultella*
- ♂ underside of forewing without small patch of narrow white scales, hair-pencil grey. ♀ frontal tuft black, occasionally mixed with some fuscous and/or yellow scales. Aedeagus with group of about 20 long cornuti (fig. 406) . . . . . 50. *minimella*
20. Forewing with white spots in addition to costal and dorsal spots or fascia . . . . . 21
- Forewing with either fascia or costal and dorsal spot only . . . . . 27
21. Forewing with discal spot beyond middle. Frontal tuft fuscous black . . . . . 22
- Forewing without discal spot in second half. Frontal tuft usually with at least some yellow scales, but occasionally dark . . . . . 23
22. Thorax completely white. Forewing with basal spot (sometimes small). ♀ with group of long hairs on tergites 7 and 8. Feeds on evergreen *Quercus* . . . . . 21. *algeriensis*
- Thorax fuscous black, with at most a white distal half. Forewing without basal spot, but sometimes with some white scales. ♀ with only few long hairs on T7 and 8. Feeds on deciduous *Quercus* . . . . . 20. *quinquella*
23. Forewings with many white scales scattered in basal half, sometimes becoming a discal spot or even confluent with other spots . . . . . 24
- Forewings with only a basal spot or basal-dorsal streak, scattered white scales absent or practically so . . . . . 25
24. Frontal tuft yellowish orange to light ferruginous, never with fuscous scales. ♀ with blunt ovipositor. ♂ genitalia: valva without pointed tip (fig. 241), aedeagus fig. 361 . . . . . 10. *hannoverella*
- Frontal tuft light yellowish or yellowish fuscous to dark fuscous, never orange (light-headed ♂ can not always be identified with certainty on externals). ♀ with pointed ovipositor (visible without dissection). ♂ genitalia: valva with pointed tip (fig. 242), aedeagus fig. 362 . . . . . 11. *turbidella*
25. Costal spot distinctly more proximal than dorsal spot, not forming a fascia. Basal spot clearly separate from dorsal. ♂ with costal bristles. ♀ without patch of long tactile hairs on T7 and 8 . . . . . 33—36. *subbimacullella*-complex
- Costal spot opposite dorsal, usually forming a fascia. Basal spot extending along dorsal margin, often confluent with fascia. ♂ with hair-pencil or costal bristles. ♀ with patch of many long tactile hairs on T7 and 8 . . . . . 26
26. Thorax white. Frontal tuft intensively orange. ♂ with costal bristles. ♀ terminalia complex, with thickened anterior apophyses (fig. 444) . . . . . 23. *leucothorax*
- Thorax fuscous black. Frontal tuft yellowish, or mixed with fuscous. ♂ with hair-pencil. Anterior apophyses not especially thickened (fig. 436) . . . . . 15. *caradjai*
27. Fascia or spots shining metallic silver (feed all on Rosaceae) . . . . . 38
- Fascia or spots dull white or yellowish white (various foodplants, including Rosaceae) . . . . . 28
28. Costal and tornal spot opposite, often forming fascia. ♂ hindwing without costal bristles, in some species with hair-pencil . . . . . 30
- Dorsal spot distinctly beyond costal spot, usually not forming a fascia. ♂ hindwing with costal bristles, hair-pencil absent . . . . . 29
29. Thorax usually uniform dark. Forewing ground colour almost uniformly blackish brown, scales only slightly lighter at bases. ♂ aedeagus with two pairs of carinae, valva fig. 244. ♀ bursa with pectinations. Larva on *Ulmus* . . . . . 14. *preisseckeri*
- Thorax usually with white tips of mesoscutum and tegulae. Forewing ground colour fuscous blackish, slightly speckled because of lighter scale bases. ♂ aedeagus with one pair of carinae, valva figs. 261—264. ♀ bursa without pectinations. Larva on deciduous *Quercus* 29—32. *albifasciella*-complex
- Thorax with or without white tips. Forewing ground colour brown, more irrorate than preceding species, scales, especially at forewing tip only dark at their tips. ♂ aedeagus with one pair of carinae, valva fig. 255. ♀ bursa without pectinations. Larva on evergreen *Quercus* . . . . . 24. *haraldi*
30. Basal half of forewing with scattered white scales . . . . . see 24
- Basal half of forewing never with white scales, outside the spots . . . . . 31
31. Large species, forewing length 2.6—3.2 mm. Antennae in ♂ with 49—60 segments, in ♀ with 34—39. ♂ with hair-pencil, never with brown lamellar androconial scales . . . . . 32
- Smaller species, forewing length 1.7—2.5 mm. Antennae in ♂ with 30—40, in ♀ with 23—35 segments. ♂ with or without hair-pencil, with or without brown androconial scales . . . . . 35



32. Costal and dorsal spot forming distinct fascia. ♂ with white or brown hair-pencil. ♀ with broad oval signa of same length. Mediterranean species, feed on evergreen *Quercus* ..... 33
- Costal and dorsal spot clearly separate. ♂ with yellow hair-pencil. ♀ with elongate signa of different length. European species, feed on *Populus* ..... 34
33. ♂ hair-pencil white. Capsule length 260—300 µm. ♀ with dense patch of very long tactile hairs on T7 and 8 (fig. 437) ..... 17. *suberis*
- ♂ hair-pencil ochreous-brown. Capsule length 220—260 µm. ♀ without long tactile hairs on T7 and 8 (fig. 438) . . 18. *andalusiae*
34. ♂, or ♀ with 34—38 antennal segments. On *P. alba* ..... 12. *klimeschi*
- ♀ only, parthenogenetic, with 26—32 antennal segments. On *P. tremula* ..... 13. *argyropeza*
35. ♂ with patch of brown androconial scales on upperside of hindwing and underside of forewing. Forewings ochreous brown, or greyish brown with yellowish tinge, comparatively light. Fascia ill-defined. Mediterranean species ..... 36
- ♂ without brown androconial scales. Forewings definitely dark, fuscous black. Fascia distinct. Species from central and southeastern Europe ..... 37
36. Frontal tuft yellow, orange or fuscous. ♂ without hair-pencil. ♀ genitalia with elongate signa (fig. 202) ..... 38. *terebinthivora*
- Frontal tuft yellowish white. ♂ with yellowish white hair-pencil. ♀ genitalia with small oval signa (fig. 176) . 19. *aegilopidella*
37. Very small species, forewing length 1.7—2.1 mm. ♂ without hair-pencil. Aedeagus with spinose dorsal process and ventral carinae. ♀ genitalia with vaginal sclerite. Feeds on *Filipendula vulgaris* ..... 42. *hexapetalae*
- Larger, forewing length 2.2—2.5 mm. ♂ with yellowish white hair-pencil. Aedeagus without carinate processes. ♀ genitalia without vaginal sclerite. Feeds on *Spiraea media* ..... 40. *spiraeae*
38. Frontal tuft very dark, blackish fuscous. ♂ hindwing with white hair-pencil ..... 46. *rubivora*
- Frontal tuft varying from yellowish orange or pale ochreous to fuscous, but never black. ♂ hindwing with or without hair-pencil ..... 39
39. Forewing with costal and dorsal spot usually separate, dorsal spot distinctly beyond costal spot. Frontal tuft ferruginous, with sometimes fuscous scales on crown; collar yellowish white. ♂ hindwing without hair-pencil ..... 39. *erythrogenella*
- Forewing with costal and dorsal spot often united to form constricted fascia. Dorsal part of fascia not distinctly beyond costal part. ♂ hair-pencil present or absent . . . 40
40. ♂ ..... 41
- ♀ ..... 45
41. Hindwing with fuscous hair-pencil, surrounded by patch of brown scales. Small species, forewing length 1.4—2.1 mm ..... 47. *spinossella*
- Hindwing with white hair-pencil ..... 42
- Hindwing without hair-pencil ..... 44
42. Collar yellowish orange to ferruginous, approximately same colour as frontal tuft. Valvae with inner margin distinctly sinuate ..... 43. *angulifasciella*
- Collar brown to black, darker than frontal tuft. Valvae with inner margin approximately straight ..... 43
43. Frontal tuft ferruginous yellow, often mixed with fuscous. Smaller species, forewing length 1.8—2.3 mm. Feeds on *Fragaria* and *Potentilla* ..... 46. *arcuatella*
- Frontal tuft orange to ferruginous. Slightly larger, forewing length 2.2—2.7 mm. Feeds on Rosaceous trees and *Staphylea* ..... 44. *atricollis*
44. Frontal tuft yellowish to ferruginous, or even fuscous. Collar greyish brown. Scape often with brown scales. Forewing length 2.3—3.0 mm. Tegumen pointed. Feeds on *Agrimonia* ..... 41. *agrimoniae*
- Frontal tuft and collar yellowish orange to ferruginous. Scape uniform white. Forewing length 1.9—2.4 mm. Tegumen rounded. Feeds on *Prunus* spp. . . 48. *mahalebella*
45. Collar and frontal tuft concolorous, yellowish orange to ferruginous ..... 46
- Collar distinctly different in colour from frontal tuft: greyish brown to fuscous black. Frontal tuft yellowish orange to fuscous ..... 47
46. Larger species, forewing length 2.0—2.9 mm. Signa elongate (figs. 211, 212) ..... 43. *angulifasciella*
- Smaller species, forewing length 1.9—2.4 mm. Signa oval (fig. 219, 220) ..... 48. *mahalebella*
47. Scape usually with some brown scales, es-

- pecially along distal margin. Collar greyish brown. Ovipositor slightly pointed . . . . . 41. *agrimoniae*
- Scape uniform white. Collar fuscous to black. Ovipositor blunt . . . . . 48
48. Small or medium sized species, forewing length 1.4—2.4 mm. Signa length 200—370  $\mu\text{m}$  . . . . . 49
- Larger species, forewing length 2.3—2.8 mm. Signa distinctly longer, 380—490  $\mu\text{m}$ . Feeds on Rosaceous trees and *Staphylea* . . . . . 44. *atricollis*
49. Small species, forewing length 1.4—2.1 mm. Signa with smooth, uniformly curved outline, longest 250—370  $\mu\text{m}$ , shortest 230—330  $\mu\text{m}$ , 2.4—3.5  $\times$  as long as wide. Feeds on *Prunus* spp. . . . . 47. *spinosella*
- Medium sized species, forewing length 1.7—2.4 mm. Signa with irregular outline, longest 230—310  $\mu\text{m}$ , shortest 205—280  $\mu\text{m}$ , 3.1—4.1  $\times$  as long as wide. Feeds on *Fragaria* or *Potentilla* . . . . . 45. *arcuatella*
- Based mainly on male genitalia<sup>1)</sup>
1. Aedeagus with three pairs (two in *liguricella*) of carinae, with ventral pair usually very prominent and longer than other carinae; dorsal carinae sometimes composed of several spines (palmate). Valva: tip straight or only very slightly curved inwards; often an inner (mesal) lobe present; large genitalia, capsule 320—430  $\mu\text{m}$ , aedeagus 370—500  $\mu\text{m}$ . (350 in *nuristanica*); valva longer than 270  $\mu\text{m}$ . Subgenus *Zimmermannia* . . . . . 2
- Aedeagus with one or two pairs of carinae, or carinae absent, ventral pair not more pronounced and larger than dorsolateral pair. Valva tip usually curved inwards, inner lobe absent. Genitalia usually smaller, capsule 150—320  $\mu\text{m}$  (—390 in *occultella*); aedeagus 205—410  $\mu\text{m}$ ; valva shorter than 270  $\mu\text{m}$  (except *leucothorax* and *occultella*, to 320  $\mu\text{m}$ ). Subgenus *Ectoedemia* . . . . . 9
2. Aedeagus with two pairs of carinae, the ventral pointed and widely separate. Aedeagus with two distal spinose lobes (figs. 356—358). Valva (fig. 238) with inner lobe. Tegumen with tongue shaped process (fig. 336) . . . . . 8. *liguricella*
- Aedeagus with three pairs of carinae, the ventral not widely separate, aedeagus without spinose lobes. Tegumen without tongue-shaped process . . . . . 3
3. Capsule very wide ( $\pm$  370  $\mu\text{m}$ ), almost as wide as long. Valva broad (fig. 236). Aedeagus almost half as wide as long, dorsal carinae comprising row of 4—5 teeth 6. *amani*
- Capsule narrower, less than 360  $\mu\text{m}$  wide. Valva narrower, aedeagus less than half as wide as long. Dorsal carinae simple, bifid or palmate . . . . . 4
4. Ventral carinae prominent, long and pointed, larger than dorsal and lateral pairs. Hindwing with hair-pencil . . . . . 5
- Ventral carinae about same size as dorsal and lateral, with bifurcate tip. Valva narrowed before tip (fig. 237). Hindwing without hair-pencil . . . . . 7. *nuristanica*
5. Valva with prominent inner lobe, approximately in middle . . . . . 6
- Valva without inner lobe, or with very slight lobe, not projecting beyond inner margin . . . . . 7
6. Gnathos with narrow pointed central element. Aedeagus with palmate dorsal carinae and stout triangular cornutus . . . . . 5. *monemvasiae*
- Gnathos with broad triangular central element. Aedeagus with single or bifurcate dorsal carinae, without stout cornutus . . . . . 4. *hispanica*
7. Aedeagus clearly constricted in middle. Dorsal and lateral carinae connected by distinct rim . . . . . 8
- Aedeagus not constricted in middle. Dorsal and lateral carinae not connected by rim . . . . . 3. *longicaudella*
8. Outer margin of ventral carinae distinctly serrate. Tip of valva rounded. Ventral arm of transtillae very short . . . . . 1. *atrifrontella*
- Outer margin of ventral carinae smooth or with a few spines. Tip of valva always slightly hooked. Ventral arm of transtillae usually longer . . . . . 2. *liebwerdella*
9. Aedeagus with ventral and dorso-lateral carinae . . . . . 10
- Aedeagus with ventral carinae only, sometimes divided, or none at all . . . . . 14
10. Dorso-lateral carinae stout, curved in lateral view, larger than ventral pair, often bifurcate. Ventral carinae connected by basal plate . . . . . 11
- Dorso-lateral carinae same size as ventral carinae or smaller, not particularly stout. Ventral carinae not similarly connected . . . . . 12
11. Valva ending in abruptly narrowed tip. Ae-

<sup>1)</sup> Males of *E. alnifoliae* are unknown.

- deagus not markedly asymmetrical (fig. 362) ..... 11. *turbidella*
- Valva gradually narrowing towards tip. Aedeagus markedly asymmetrical (figs. 363, 400, 401) ..... 12. *klimeschi*
12. Ventral carinae curved, often overlapping (fig. 364). Gnathos triangular, pointed ..... 14. *preisseckeri*
- Ventral carinae straight, distinctly separate. Gnathos with rounded central element . . . 13
13. Valva with broad blunt tip, widest beyond middle. Gnathos with spines on central element ..... 10. *hannoverella*
- Valva with pointed tip, widest at basis. Gnathos broad, without spines 9. *intimella*
14. Tegumen cuspidate, long pointed. Carinae divided each in at least 4 similar spines (figs. 394, 397, 398) ..... 15
- Tegumen triangular, rounded or blunt. Carinae single, or with some additional, usually smaller, spines ..... 17
15. Small species, aedeagus 180—230  $\mu\text{m}$ . Carinae distinctly below tip of aedeagus, with pointed tips. Ventral process with some spines. Gnathos triangular . 41. *agrimoniae*
- Large species, aedeagus at least 280  $\mu\text{m}$  long. Carinae with blunt tips reaching tip of aedeagus. Ventral process smooth. Gnathos blunt ..... 16
16. Aedeagus with small triangular cornuti only (fig. 405). Gnathos with very wide, blunt, central element (fig. 327). Comparatively large, aedeagus 305—350  $\mu\text{m}$  . 49. *occultella*
- Aedeagus with a row of about 20 long elongate cornuti at right side (fig. 406). Gnathos with narrow, truncate, central element (fig. 328). Smaller species, aedeagus 280—310  $\mu\text{m}$  ..... 50. *minimella*
17. Aedeagus without any carinae. Tegumen protruding, triangular (fig. 127). Gnathos with central element reduced (fig. 318). Valva fig. 271 ..... 40. *spiraecae*
- Aedeagus with ventral carinae. If tegumen protruding, than blunt or rounded. Gnathos usually with distinct central element ..... 18
18. Aedeagus dorsally with medial spinose process (fig. 403, 404). Small species, capsule 195—240  $\mu\text{m}$ , as wide as long, and aedeagus relatively long, 260—290  $\mu\text{m}$  ..... 42. *hexapetae*
- Aedeagus without dorsal spinose process ..... 19
19. Capsule 150—170  $\mu\text{m}$  long, wider than long. Tegumen bulbous (fig. 410). Gnathos with central element in form of transverse bar (fig. 298) ..... 19. *aegilopidella*
- Capsule longer than 190  $\mu\text{m}$ . Tegumen not bulbous. Gnathos with central element not in form of transverse bar ..... 20
20. Carinae with many small additional spines at base (figs. 28, 390—393). Tegumen prominent, longer than wide, cut off (fig. 413). Valva with inner margin straight or slightly sinuous ..... 21
- Carinae without or with few additional spines. Tegumen triangular, rounded or wider than long ..... 22
21. Valva with inner margin sinuous, forming a slight bulge beyond middle (fig. 273). Capsule length 210—260  $\mu\text{m}$ , aedeagus 215—275  $\mu\text{m}$  ..... 43. *angulifasciella*
- Valva with inner margin straight below apex (figs. 274—276) ..... 44. *atricollis* (capsule 270—290  $\mu\text{m}$ , aedeagus 260—290  $\mu\text{m}$ , head orange)
46. *rubivora* (capsule 255—285  $\mu\text{m}$ , aedeagus 235—265  $\mu\text{m}$ , head black)
45. *arcuatella* (capsule 250—255  $\mu\text{m}$ , aedeagus 230—245  $\mu\text{m}$ , head orange)
22. Valva with many setae on dorsal and inner surface, the prominent sockets result in a distinctly serrate inner margin (figs. 260—266). Gnathos undivided, without serrate margins. (Hindwing with costal bristles) 23
- Valva with comparatively few setae on inner and dorsal surface, usually restricted to posterior half; rarely a few prominent sockets along inner margin, never distinctly serrate. Gnathos divided or undivided, with or without serrate margins. (Hindwing with or without hair-pencil or costal bristles) 24
23. Gnathos with central element truncate (figs. 307—312). Aedeagus with carinae simple . . . 29—32. *albifasciella*-complex (forewing with white spots)
28. *nigrosarsella* (forewing irrorate)
- Gnathos with central element rounded (figs. 313—315). Aedeagus with carinae usually with a few additional spines ..... 33—36. *subbimaculella*-complex
24. Tegumen wider than long, truncate (fig. 412). Gnathos with very short central element. Valva fig. 268 . . . 38. *terebinthivora*
- Tegumen longer than wide, or not protruding at all. Gnathos with conspicuous central element ..... 25
25. Valva with inner margin almost straight up to the distinctly separate apex. Small species, capsule length 190—225  $\mu\text{m}$  ..... 26



- Valva with inner margin markedly concave, especially in distal half, with gradual transition into apex. Small or large species . . . 27
26. Gnathos with smooth triangular central element. Valva with apex almost posteriorly pointing (fig. 269) . . . . . 39. *erythrogenella*
- Gnathos divided, basal part with more or less serrate margin. Valva with inwards curved apex (figs. 277, 278) . . . . . 47. *spinosella* (with hair-pencil)  
 . . . . . 48. *mahalebella* (without hair-pencil)
27. Gnathos with smooth, undivided triangular or tongue-shaped central element. Aedeagus distinctly longer than capsule, carinae simple . . . . . 28
- Gnathos with divided central element, basal part with serrate margins, distal part spatulate. Aedeagus about as long as capsule, shorter or slightly longer. Carinae usually with additional spines . . . . . 31
28. Valva with inner margin basally convex, apically concave, with sharp delimitation. Aedeagus very long, 310—395  $\mu\text{m}$  . . . . . 29
- Valva with inner margin basally hardly convex, without sharp delimitation between basal part and concave distal part. Aedeagus shorter, 275—290  $\mu\text{m}$  (305 in specimen 1843) . . . . . 30
29. Tegumen produced in broadly triangular pseuduncus with rounded tip. Capsule longer than 260  $\mu\text{m}$  . . . . . 17. *suberis*
- Tegumen broad, truncate, not produced into pseuduncus. Capsule 225—235  $\mu\text{m}$  . . . . . 18. *andalusiae*
30. Tegumen produced into distinct rounded pseuduncus. Aedeagus 275—290  $\mu\text{m}$  . . . . . 15. *caradjai*
- Tegumen truncate, not produced into pseuduncus. Aedeagus 305  $\mu\text{m}$  . . . . . 16. specimen 1843
31. Valva with very prominent bulging outer margin (fig. 255) . . . . . 24. *haraldi*
- Valva with outer margin uniformly convex . . . . . 32
32. Valva dorsal surface with back-folded lobe (fig. 253). Hindwing with prominent black hair-pencil . . . . . 22. *gilvipennella*
- Valva without dorsal lobe. Hindwing with lighter hair-pencil or without . . . . . 33
33. Valva extremely long and narrow (fig. 254), longer than 270  $\mu\text{m}$ . Aedeagus distinctly shorter than capsule . . . . . 23. *leucothorax*
- Valva not extremely long and narrow, shorter than 260, usually shorter than 220  $\mu\text{m}$ . Aedeagus as long as capsule or longer . . . . . 34
34. Hindwing with costal bristles. Forewing with dorsal spot only . . . . . 35
- Hindwing with hair-pencil. Forewing with at least three spots . . . . . 36
35. Hindwing upperside and forewing underside with brown androconial scales . . . . . 26. *heringella*
- Androconial scales absent . . . . . 25. *ilicis*
36. Tip of valva pointed. Hair-pencil yellowish . . . . . 20. *quinquella*
- Tip of valva truncate. Hair-pencil white . . . . . 21. cf. *algeriensis*
- Based mainly on female genitalia<sup>1)</sup>
1. Corpus bursae longer than 880  $\mu\text{m}$ , usually longer than 1000  $\mu\text{m}$ . Vestibulum with inconspicuous sclerotisations or spines, without vaginal sclerite. Margin of signa wider than individual cells. Subgenus *Zimmermannia* . . . . . 2
- Corpus bursae usually shorter than 880  $\mu\text{m}$ , but occasionally up to 935  $\mu\text{m}$ , and then always with vaginal sclerite. Margin of signa narrower than individual cells. Subgenus *Ectoedemia* . . . . . 6
2. Ductus spermathecae with 12½—13 convolutions. Vestibulum with two groups of spines . . . . . 6. *amani*
- Ductus spermathecae with 4½—5¼ convolutions . . . . . 3
- Ductus spermathecae with 2½—3¾ convolutions . . . . . 5
3. T7 with large patch of long tactile hairs, extending almost to anterior margin (fig. 426) . . . . . 7. *nuristanica*
- T7 with long hairs only at posterior margin . . . . . 4
4. T7 and 8 with dense bunch of many long hairs (fig. 424). Longest signum longer than 500  $\mu\text{m}$ . Eastern mediterranean species . . . . . 5. *monemvasiae*
- T7 and 8 with some long setae in a row, not forming a dense bunch (figs. 427, 428). Longest signum shorter than 500  $\mu\text{m}$ . Western mediterranean species . . . . . 8. *liguricella*
5. Ductus spermathecae with 3½—3¾ convolutions . . . . . 3. *longicaudella*
- Ductus spermathecae with 2½—3 convolutions . . . . . 1. *atrifrontella* or  
 . . . . . 2. *liebwerdella*

<sup>1)</sup> Females of *E. hispanica* are unknown.



6. Corpus bursae without pectinations, completely smooth outside signa. A group of densely packed pectinations present in vestibulum ..... 7
- Corpus bursae mostly covered with small pectinations or spines. Densely packed pectinations in vestibulum may be either present or absent ..... 14
7. Signa of about same length, approximately  $2.6-3.4 \times$  as long as wide. Anterior apophyses much widened (fig. 444). Large group of many long hairs along posterior margin of T7 ..... 23. *leucothorax*
- Signa distinctly dissimilar, more than  $3.5 \times$  as long as wide. Anterior apophyses not markedly widened ..... 8
8. Ductus spermathecae with more than  $3\frac{1}{2}$  convolutions ..... 9
- Ductus spermathecae with  $2-3\frac{1}{4}$  convolutions ..... 10
9.  $3\frac{1}{2}-4$  convolutions ..... 30. *cerris*
- $5-6$  convolutions ..... 31. *pubescivora*
- $10\frac{1}{2}-12$  (rarely  $13\frac{1}{2}$ ) convolutions ..... 32. *contorta*
- $13\frac{1}{2}-14$  convolutions .. 28. *nigrosarsella*
10. T7 and 8 with in total more than 70 setae, including some very long (fig. 441). Anal papillae each with more than 24 setae ..... 21. *algeriensis*
- T7 and 8 with much fewer setae, usually not exceeding 25. Anal papillae with less than 24 setae ..... 11
11. Abdominal tip narrow, T8 and 9 with distinctly converging margins (fig. 429). Spiculate pouch with small, single denticles, approximately equally spaced ... 9. *intimella*
- Abdominal tip wider, T8 and 9 not so distinctly converging. Spiculate pouch with small denticles, often in small groups, not equally spaced ..... 12
12. T7 with distinct row of  $6-14$  setae along posterior margin ..... 13
- T7 without such a row, at most few scattered short setae ..... 24. *haraldi*, 20. *quinquella* or 27. *alnifoliae*, compare externals and figures of female terminalia (figs. 445, 440, 449).
13. Sides of S8 almost parallel. Convolution of ductus spermathecae very wide (fig. 416) ... 29. *albifasciella*
- Sides of S8 diverging anteriorly. Convolution of ductus spermathecae narrow (figs. 417, 418) ..... 22. *gilvippennella*, 25. *ilicis*, 26. *heringella* or 33-36. *subbimaculella*-complex, compare externals and figures of female terminalia.
14. T7 and 8 covered with many (more than 100) very long hairs, reaching abdominal tip. Ductus spermathecae with  $3\frac{1}{2}-4\frac{1}{2}$  convolutions ..... 15
- T7 and 8 covered with few short setae only, at most 20. Ductus spermathecae either with  $5\frac{1}{2}$  or less than  $3\frac{1}{2}$  convolutions ... 16
15. Bursa almost globular. Long setae smooth. Ductus spermathecae with  $4-4\frac{1}{2}$  distinct convolutions. Abdominal tip fig. 437 ..... 17. *suberis*
- Bursa elongate. Long setae pectinate. Ductus spermathecae with  $3\frac{1}{2}-4$  less distinct convolutions. Abdominal tip fig. 436 ..... 15. *caradjai*
16. Ductus spermathecae with  $5\frac{1}{2}$  convolutions ..... 18. *andalusiae*
- Ductus spermathecae with  $2-3\frac{1}{2}$  convolutions ..... 17
17. Vestibulum with patch of densely packed pectinations near entrance to ductus spermathecae. Vaginal sclerite present. Spiculate pouch conspicuous, usually with many distinct spines ..... 18
- Vestibulum without patch of densely packed pectinations. Vaginal sclerite present or absent. Spiculate pouch inconspicuous or absent ..... 23
18. Signa completely different in form and length, longest reaching into vestibulum, shortest  $4.2-5.0 \times$  as long as wide. Terminalia fig. 459 ..... 38. *terebinthivora*
- Signa similar in form, sometimes slightly different in length, not reaching into vestibulum ..... 19
19. T7 with distinct row of  $4-12$  setae along posterior margin. Spines of spiculate pouch not all equally spaced, or very few only . 20
- T7 without distinct row of setae along posterior margin. Spines of spiculate pouch distinct, all equally spaced, not grouped ... 21
20. Signa  $2.4-3.0 \times$  as long as wide. Terminal segments narrow, fig. 435 .. 14. *preisseckeri*
- Signa  $3.0-5.6 \times$  as long as wide. Terminal segments wider, fig. 460 39. *erythrogenella*
21. T8 and 9 posteriorly narrowed, forming pointed ovipositor. Posterior apophyses widened at anterior tips (figs. 431, 432). .... 11. *turbidella*
- T8 and 9 not so much narrowed, ovipositor blunt. Posterior apophyses not distinctly widened ..... 22

22. T8 about 2 × as wide as long (fig. 430). Anal papillae with 6—11 setae. Signa 390—480 μm. S8 without pronounced corners . . . . . 10. *hannoverella*
- T8 more than 2 × as wide as long (fig. 433). Anal papillae with 9—11 setae. Signa 373—416 μm. S8 with pronounced corners . . . . . 12. *klimeschi*
- T8 more than 2 x as wide as long (fig. 434). Anal papillae with 5—9 setae. Signa 270—394 μm long. S8 without pronounced corners . . . . . 13. *argyropeza*
23. Anal papillae with 18—40 setae. Terminal segments wide (figs. 470, 471). Pectinations in bursa in two longitudinal bands, running halfway between the signa 49. *occultella* or . . . . . 50. *minimella*
- Anal papillae with 4—16 setae. Terminal segments not so wide. Pectinations in bursa more regularly distributed . . . . . 24
24. Vestibulum completely smooth, without vaginal sclerite or spiculate pouch. T8 divided in middle. . . . . 25
- Vestibulum with vaginal sclerite, although sometimes indistinct, and sometimes with inconspicuous spiculate pouch. T8 undivided . . . . . 26
25. Signa dissimilar, 320—440 μm long. Anal papillae with 13—16 setae. Terminal segments fig. 461 . . . . . 40. *spiraeae*
- Signa similar, 180—300 μm long. Anal papillae with 7—12 setae. Terminal segments fig. 462 . . . . . 41. *agrioniae*
26. Bursa very small, 310—350 μm. Signa short, 189—223 μm, oval, occupying large part of bursa . . . . . 19. *aegilopidella*
- Bursa larger, 570—715 μm. Signa short, 200—300 μm, oval, confined to posterior half of bursa . . . . . 48. *mahalebella*
- Bursa intermediate, 400—660 μm. Signa variable in length, elongate, throughout bursa . . . . . 42. *hexapetae*, 47. *spinossella* and 43—46. *angulifasciella*-complex, compare externals, diagnoses, or genitalia figures.

### Subgenus *Zimmermannia* Hering

*Zimmermannia* Hering, 1940: 266. Type-species: *Ectoedemia liebwerdella* Zimmermann, 1940, by original designation and monotypy.

*Ectoedemia* sensu Klimesch, 1953: 163 [European species].

*Ectoedemia* (*Zimmermannia*); Schönherr, 1958: 6; Borkowski, 1972: 699; Emmet, 1976: 188, 203.

*Ectoedemia castaneae* group sensu Wilkinson & Newton, 1981: 72.

### Description.

Adult. Relatively large nepticulid moths, forewing length 2.8—4.5 mm, wingspan 6.4—9.8 mm (in Palaearctic species).

Head. Antennae long, more than half length of forewing, in male with 36—58 segments, in female with 36—49 segments. Scape and pedicel white, flagellum darker.

Wings. Uniform irrorate ochreous or yellowish-white, with darker scaling, often predominantly brown, without fascia, sometimes a small dorsal (tornal) and/or costal spot present. Cilia-line not distinct. Hindwing in male without costal bristles, hair-pencil present in most species, surrounded by special scales. Humeral lobe often prominent, beyond which hindwing is suddenly emarginated (figs. 10—14).

Forewing venation (fig. 8). R and M + Cu forming closed cell, branches R<sub>1</sub>, R<sub>2+3</sub>, R<sub>4</sub>, R<sub>5</sub>, M and Cu present. A thickened, without anal loop. Cu and A often very long, seeming fused at tips.

Male genitalia. Vinculum ring-shaped, anterior extension not long, anteriorly convex. Tegumen slightly produced into a triangular or blunt pseuduncus. Uncus absent. Gnathos with prominent spatulate or triangular central element, margins smooth. Valva approximately triangular, tip not separate, usually not curved inwards; often with a mesal (inner) lobe. Aedeagus stout, with large ventral carinae, smaller dorso-lateral carinae and usually dorsal carinae. Ventral carinae fitting by membranes to fold in dorsal surface of valvae. Dorsal carinae palmate in some species. Vesica with numerous denticulate cornuti and usually one large cornutus or sclerotised plate posteriorly.

Female genitalia. On tergites 7 and 8, near anterior margin of T8 usually a group or row of very long setae, T8 with many shorter setae, without scales. Anal papillae with setae. Posterior apophyses often reaching beyond anterior apophyses. Vestibulum with indistinct paired sclerotisation, or with groups of spines, vaginal sclerite or spiculate pouch absent. Corpus bursae long, elongate, covered with pectinations, except in anterior part, arranged in concentric bands around long signa. Margin of signa wider than individual cells.

Larva. Long yellow larvae with strongly sclerotised head-capsule, feeding venter upwards.

See Schönherr (1958) and van Nieukerken & Jansen (in preparation). *E. liebwerdella* has six to eight larval instars (Schönherr, 1958).

### Biology.

The larvae of the species where the life history is known, are bark-miners (or gall-makers in bark: *E. castaneae*) in Fagaceae (*Fagus*, *Quercus*, *Castanea*), and Ulmaceae (*E. amani* only). The mines are galleries. The larvae feed for one or two years and leave the mine in spring to pupate in the soil. Adults fly throughout the summer. The life-history became particularly well-known through the excellent work of Schönherr (1958) on *E. liebwerdella*, and the studies of Busck (1913, 1914a,b) on American species.

### Distribution and composition.

Eight species are described here from the Western Palaearctic region as far east as Afghanistan, two species (*E. admiranda* and *E. sivickisi*) were described by Puplesis (1984b) from the Eastern Palaearctic region, and twelve species were recorded from North America by Wilkinson & Newton (1981) and Wilkinson (1981), and more unnamed Nearctic species are present in collections.

### Remarks.

The species of this subgenus are remarkably uniform both in external features and genitalia, also when the Nearctic species are taken into consideration. Although the life history of only 3 Nearctic and 4 Palaearctic species is (partly) known, it seems very probable that all species are bark-miners, and the majority feeds on Fagaceae. Several of the species of which the life-history is unknown have also been collected in vegetation containing many Fagaceae (*Quercus*). There are mines also known which have not yet been associated with existing species. Schönherr (1958) for instance reported mines on *Carpinus*, and he and Klimesch (1953) on *Castanea*. I also found mines on *Castanea* and *Quercus ilex* in the south of France, and on *Q. coccifera* in Spain. Unfortunately rearing of *Zimmermannia* larvae proved very difficult, so it will probably be a long time before the life-histories of all species have been worked out.

### 1. *Ectoedemia* (*Zimmermannia*) *atrifrontella* (Stainton, 1851)

(figs. 8, 10, 33, 34, 35, 89, 143, 144, 231, 281, 329, 337, 338, 346, 421, 472, 514)

*Trifurcula atrifrontella* Stainton, 1851: 11. 2 Syntypes, England, G. Bedell (depository unknown) [not examined].

*Zimmermannia heringiella* Doets, 1947: 504—506, 5 figs. Lectotype ♂ (here designated), Netherlands: Hollandse Rading, 15.viii.1946, c.l. *Quercus*, J. Doets, Genitalia slide V. 679 on pin (RMNH) [examined, genitalia figured by Doets]. [Synonymised by Klimesch, 1953].

*Trifurcula atrifrontella*; Stainton, 1854: 306; Herrich-Schäffer, 1855: 360; Stainton, 1859: 438; Wocke, 1871: 335; 1874: 97; Heinemann & Wocke, 1877: 726; Meyrick, 1895: 727; Tutt, 1899: 358; Rebel, 1901: 221; Meess, 1910: 482; Meyrick, 1928: 864; Beirne, 1945: 207, 208; Gerasimov, 1952: 202; Karsholt & Nielsen, 1978: 3, 4, figs. 7, 8 (♂ genitalia).

*Ectoedemia atrifrontella*; Klimesch, 1953: 191—193, fig. 18 (revision, ♂ genitalia); 1961: 749; Lhomme, 1963: 1210; Szócs, 1965: 49; Bradley et al., 1972: 3; Borkowski, 1975: 496; Emmet, 1976: 203, pl. 7 fig. 5, pl. 12 fig. 37.

*Trifurcula* (*Ectoedemia*) *atrifrontella*; Johansson, 1971: 245.

Diagnosis: the white thorax together with the black head separate *atrifrontella* from other *Zimmermannia* species, the snow-white hair-pencil in the male is a good additional character separating it from *longicaudella*. The narrow capsule, constricted aedeagus, serrate carinae and short ventral arms of transtilla are diagnostic characters of the male genitalia. The female genitalia differ from *longicaudella* by shorter posterior apophyses and lower number of convolutions in ductus spermathecae, but cannot be separated from *liebwerdella*.

### Description.

Male (fig. 35). Forewing length 2.88—3.24 mm ( $3.05 \pm 0.13$ , 12), wingspan 6.5—7.4 mm. Head: frontal tuft and collar dark brown to black. Antennae long, with 45—53 segments ( $48.3 \pm 2.7$ , 7). Thorax yellowish white, except brown caudal tips of mesoscutum and tegulae. Forewings dark brown, irrorate with varying amount of white, tornal spot usually white; cilia silvery white beyond ill-defined cilia-line. Hindwing (fig. 10) with snow-white hair-pencil of approximately  $\frac{1}{4}$  hindwing length, surrounded by white lamellar scales; humeral lobe prominent, costal margin distinctly emarginated beyond hair-pencil.

Female. Forewing length 3.2—3.84 mm ( $3.59 \pm 0.23$ , 9); wingspan 7.2—8.5 mm. Antennal segments 37—49 ( $42.2 \pm 3.2$ , 10).



Male genitalia (figs. 89, 329). Capsule length 390—411  $\mu\text{m}$  ( $404.2 \pm 8.7$ , 7), slender, width 274—304  $\mu\text{m}$ . Vinculum with posterior part of ventral plate less than one third of ventral plate. Tegumen slightly cuspidate. Gnathos (fig. 281) with central element long and narrow, parallel-sided. Valva (fig. 231) slender, length 287—321  $\mu\text{m}$  ( $297.6 \pm 12.6$ , 7), approximately triangular, without any lobe along inner margin, tip rounded; transtilla with ventral arm extremely short. Aedeagus (figs. 337, 338, 346) 450—501  $\mu\text{m}$  ( $471.4 \pm 19.2$ , 7), constricted at level of opening for ductus ejaculatorius; ventral carinae long, approximately one third of total length aedeagus, with distinct serrate outer margins; lateral and dorsal carinae connected by prominent rim, stout and pointed, the dorsal longer. Vesica with distally a sclerotised plate with indistinct folds or ridges in addition to small cornuti.

Female genitalia (figs. 33, 34, 143, 144, 421). T8 with many long hairs, more than 50, a row of 10—20 thicker and very long setae along anterior margin of T8, scales absent; anterior margin of T8 slightly indented. Anal papillae with 8—13 setae. Posterior apophyses hardly reaching beyond anterior apophyses. Vestibulum with pair of indistinct sclerotisations. Corpus bursae 1080—1270  $\mu\text{m}$ , covered with pectinations, partly in concentric bands around signa; signa elongate, similar, length 473—572  $\mu\text{m}$  ( $510 \pm 41$ , 14), 4.4—6.7  $\times$  as long as wide. Ductus spermathecae with  $2\frac{1}{2}$ —3 convolutions, becoming wider distally.

Larva. Yellow, very elongate. Head-capsule brown. Ventral plates absent.

#### Biology.

Host plants: *Quercus robur* L., *Q. pubescens* Willd. and probably other *Quercus* species. In Spain the species was collected in cork-oak woods with some *Quercus faginea* Lam., of which the latter is the most likely foodplant here.

Mine (fig. 472). Contorted gallery in smooth bark of branches and thin trunks. The larva feeds mainly in the direction of the main axis.

Life history. Incompletely known, larvae start feeding probably in summer and overwinter at least once, but analogous to *liebwerdella* and *longicaudella* it could have a two year cycle. Full grown larvae collected late May and June pupate soon and emerge within a few weeks. Adults are frequently caught at light from early July until the middle of September.

Rearing is difficult, and actually very few specimens have been reared.

#### Distribution (fig. 514).

Widely distributed in Europe from southern Finland to Spain, but not recorded from eastern Europe, except Hungary, nor from Belgium (Janmouille's 1947 record actually refers to *longicaudella*), Ireland, Norway or Portugal. This is the only *Zimmermannia* species known from Great Britain. In central and southern Europe this species is often less common than *longicaudella*. Occurrence in Anatolia (one uncertain female) has to be confirmed.

#### Remarks.

Stainton described this species from two specimens from Bedell's collection. Unfortunately these specimens could not be found in BMNH, and the collection seems to have been dispersed after auctioning, so the types remain unknown. The identity of this species however seems to be beyond doubt, since there are two subsequent correctly identified specimens in Stainton's collection, which represent this, the only British *Zimmermannia* species.

Records prior to 1953, and also several more recent ones, cannot be relied on since they refer at least partly to *E. longicaudella*.

The life-history of this species was discovered by Doets (1947), who at that time described it as the new species *Zimmermannia heringiella*. Previously *E. atrifrontella* was incorrectly believed to mine bark of *Sarothamnus*.

Material examined: 26  $\sigma$ , 18  $\varphi$ . — Austria: 5  $\sigma$ , Gumpoldskirchen, Glaslauerriegel, 10.viii.1958, 10.vii.1981, 26.viii.1983, and 1.ix.1983, F. Kasy; 1  $\sigma$ , Hundsheimer Berg, Porta Hungarica (near Hainburg), 2.vii.1977, F. Kasy (NMW). — France: 1  $\sigma$ , "Antarv". (? near Digne), 13.viii.1903, Chrétien; 1  $\sigma$ , Digne, viii.1903, Chrétien (MNHN); 2  $\sigma$ , Viens (Vaucluse) (near Apt), 6.viii.1974, 1.ix.1975, Buvat (coll. Buvat). — Germany, West: 2  $\varphi$ , Leine, Eime, 10.viii.1889, coll. J. Schlumberger. — Germany, East: 1  $\varphi$ , Altenburg, Krause (MNHN). — Great Britain: 1  $\varphi$ , Dartford Heath (Kent), 12.viii.1892, Tyerman; 1  $\sigma$ , Ham Street (Kent), 16.ix.1961, S. Wakeley (UMZC); 1  $\varphi$ , Lewisham (London), 13.viii.1851, beaten from oak, J. Stainton; 1  $\sigma$ , 1851, J. Grant, no further data (BMNH); 1  $\sigma$ , 1897, J. B. Hodgkinson, no further data; 2  $\sigma$ , no data, Whittle coll. (genitalia figured by Klimesch, 1953) (BMNH). — Hungary: 1  $\varphi$ , Nadap (near Velencei-tó), 6.ix.1951, Kovács (TMAB). — Netherlands: 3  $\sigma$ , 4  $\varphi$ , Hilversum, e.l. 10—17.viii.1948, e.l. 21.viii.1950, *Quercus*, Doets



(RMNH, 1 MHUB); 1 ♂, 3 ♀ (lecto- and paralectotypes of *beringiella* Doets), Hollandse Rading, e.l. 10—15.viii.1946, *Quercus*, Doets (RMNH, ZMA); 1 ♂, Leuvenum, Ullerberg, 1.ix.1926, a.l., P. Tutein Nolthenius; 1 ♀, Nijmegen, 7.ix.1921, Lycklama à Nijeholt (ZMA); 1 ♂, Overveen, 29.viii.1930, G. A. Bentinck (RMNH).—Spain: 2 ♂, Andalucia, road to Istan, 400 m, 28.vi.1972, E. Traugott-Olsen; 1 ♀, idem, 200 m, 8.vii.1972; 2 ♂, Andalucia, road to Caesares, 500 m, 9.vii.1973, E. Traugott-Olsen (ETO).—Switzerland: 1 ♀, Erschmatt-Rotafen (Valais), 920 m, e.l. 7.vii.1983, mine *Quercus pubescens* 21.v.1983, S. E. Whitebread (coll. Whitebread).

Mines.—Netherlands: Hollandse Rading.

Identity uncertain: Turkey: 1 ♀, Anatolia, Kizilcahamam, 700 m, 31.vii-1.viii.1963, Arenberger (LNK) (specimen damaged).

Additional records. —Italy: Latina, Monti Aurunci, Castelforte, 22.vi.1969, R. Johansson (adults at light); Piemonte (coll. Jäckh) (R. Johansson, pers. comm.).

## 2. *Ectoedemia* (*Zimmermannia*) *liebwerdella*

Zimmermann, 1940

(figs. 11, 36, 37, 90, 145, 146, 232, 282, 330, 343, 348, 422, 473, 515)

*Ectoedemia liebwerdella*; Zimmermann, 1940: 264, 265, 1 fig. Holotype ♀, Czechoslovakia: Dečín, (Tetschen) Liebwerd, 8.vi.1939, F. Zimmermann, Rindemine: *Fagus sylvat.*, Genitalia slide on pin (MHUB) [examined].

*Ectoedemia liebwerdella*; Klimesch, 1953: 195; 1961: 749; Schönherr, 1958: 1—71, figs. (detailed description of all stages and biology); Lindner, 1959: 7—8 (Distribution in West-Germany); Szöcs, 1965: 49; Haase, 1968: 61 (Distribution in East-Germany); Borkowski, 1975: 496.

*Zimmermannia liebwerdella*; Hering, 1940: 266.

*Ectoedemia* (*Zimmermannia*) *liebwerdella*; Hering, 1957: 437; Dorfmann, 1960: 17.

Diagnosis: externally similar to *longicaudella*, but tornal and costal spots more distinct, especially in female, and male with white hair-pencil. Differs from *atrifrontella* by brown thorax. Male genitalia extremely similar to *atrifrontella*, bud carinae hardly or not serrate, valva broader and ventral arms of transtilla longer. Female genitalia cannot be differentiated with certainty from *atrifrontella*.

### Description.

Male (fig. 36). Forewing length 3.00—3.04 mm (3), wingspan 6.5—6.9 mm. Head: frontal tuft and collar dark brown to black. Antennae long, with 46—48 segments (2). Thorax dark brown to blackish fuscous. Forewings dark brown to blackish fuscous, almost uniform,

sometimes slightly irrorate, tornal and to a lesser extent, costal spots white; cilia white beyond ill-defined cilia-line. Hindwing (fig. 11) with long white hair-pencil, of more than 1/3 hindwing length, surrounded by white lamellar scales. Humeral lobe and costal emargination more pronounced than in other species.

Female (fig. 37). Forewing length 3.60—3.64 mm (2), wingspan 7.8—8.4 mm. Antennal segments 40—41 (2). Costal and tornal spot more pronounced than in male.

Male genitalia (figs. 90, 330). Capsule length 377—429 μm (4), slightly wider than in *atrifrontella*: 291—343 μm. Tegumen slightly cuspidate. Gnathos (fig. 282) with central element long and narrow, parallel-sided. Valva (fig. 232) length 296—321 μm (4), approximately triangular, slender, but in comparison with *atrifrontella* wider, without any inner lobe, tip slightly hooked; transtilla with ventral arms intermediate in length between *atrifrontella* and *longicaudella*. Aedeagus (figs. 343, 348) 454—463 μm (4), constricted at level of opening for ductus ejaculatorius; ventral carinae long, approximately one third of total length aedeagus, with hardly serrate or smooth outer margins; lateral and dorsal carinae connected by prominent rim, stout and pointed, the dorsal longer. Vesica with distally a sclerotised plate with indistinct folds or ridges, in addition to small cornuti.

Female genitalia (figs. 145, 146, 422). T8 with many long hairs, a row of 16—20 thicker and very long setae along anterior margin of T8, scales absent; anterior margin slightly indented. Anal papillae with 6—10 setae. Posterior apophyses reaching slightly beyond anterior apophyses. Vestibulum with pair of indistinct sclerotisations. Corpus bursae ± 1100 μm, covered with pectinations, partly in concentric bands around signa; signa elongate, almost similar, length 390—495 μm (6), 3.6—4.0 × as long as wide. Ductus spermathecae with 2½—3 convolutions, becoming wider distally.

Larva. Yellow, very elongate. Head-capsule brown. Ventral plates absent. See also Schönherr (1958).

### Biology.

Host plant: *Fagus sylvatica* L.

Mine (fig. 473). Contorted gallery in bark of trunks or thick branches. The larva feeds mainly in the direction of the main axis. Especially abundant on sunny side of trees.

Life history. See excellent treatment by Schönherr (1958), larvae feed during two sum-

mers and overwinter twice to pupate in May–July, thus having a two-year cycle (in East Germany), but specimens completing their cycle in one year do occur (Schönherr, l.c.). Adults emerge from early July to August.

#### Distribution (fig. 515).

Adults are only known from reared material from DDR, the holotype and French and Italian specimens collected at light. Records of mines known from East and West Germany, Silesia in Poland, Austria, Hungary, Italy: Alps and Apennines, France: Alps and Pyrenees. In northernmost Germany and Denmark the species could not be found, despite intensive search (Lindner, 1959; Schönherr, 1958).

Material examined: 5 ♂, 3 ♀. — Czechoslovakia: 1 ♀ Holotype, see above.— France: 1 ♂, St. Barnabé, Col de Vence, 900 m (Alpes Marit.), 2—7.vii.1962, Arenberger (LNK). — Germany, East: 3 ♂, 2 ♀, Tharandt, e.l. 4—19.vii.1956, *Fagus sylvatica*, J. Schönherr (MHUB, 1 ZMC). — Italy: 1 ♂, Calabria-La Sila, prov. Cosenza, Longobucco, 1600 m, 3.viii.1982, at light, J. H. Kuchlein (coll. Kuchlein).

Mines. — France: l'Épine (Hautes Alpes); le Perthus (Pyr.Or.); le Sappey-en-Chartreuse (Isère).

Additional records. — Italy: Parco Nazionale d'Abbruzzo, 1700—1800 m, mines, R. Johansson (pers. comm.); Trento, Mte Maranza, 10.x.1983, mines, E. J. van Nieukerken.

### 3. *Ectoedemia (Zimmermannia) longicaudella* Klimesch, 1953

(figs. 12, 21, 27, 38, 91, 147, 148, 233, 283, 331, 339, 340, 347, 423, 516)

*Ectoedemia longicaudella* Klimesch, 1953; 193, 194, fig. 19. Lectotype ♂ (here designated), Hungary: Nagy Nyir, Kecskemét, 17—28.v.1937, J. Klimesch, Genitalia slide Kl. 438 (ZSMK) [not examined, genitalia figured by Klimesch].

*Stigmella (Fomoria) peiuui* Nemeş, 1972: 153—156, 1 fig. Holotype ♂, Rumania: Wald Girboavele, Bezirk Galaţi, 7.vii.1968, I. Nemeş, Genitalia slide 1299 (coll. Nemeş) [not examined]. **Syn. nov.**

*Trifurcula atrifrontella* sensu auct. partim.

*Ectoedemia longicaudella*; Szöcs, 1965: 50; Borkowski, 1970: 549, figs. 19, 26 (♂ genitalia, externals); 1975: 496; van Nieukerken, 1982: 106, 107.

*Trifurcula (Ectoedemia) longicaudella*; Johansson, 1971: 245.

*Ectoedemia (Zimmermannia) longicaudella*; Borkowski, 1972: fig. 12 (venation).

Diagnosis: the brown thorax and yellowish brown hair-pencil separate this species from *atrifrontella*, the hair-pencil and the absence of

a costal spot from *liebwerdella*. From both species it is distinguished by the unconstricted aedeagus, the shorter carinae, the wider capsule and longer ventral arms of transtilla in male, and by the long posterior apophyses and number of convolutions in spermathecal duct in female. See also *hispanica* and *monemvasiae*.

#### Description.

Male (fig. 38). Forewing length 2.68—3.64 mm ( $3.27 \pm 0.20$ , 28), wingspan 7.0—8.0 mm. Head: frontal tuft and collar dark brown to black. Antennae long, with 41—50 segments ( $45.2 \pm 2.5$ , 11). Thorax dark brown, often with white caudal tips of mesoscutum and tegulae. Forewings dark brown, irrorate with varying amount of white, tornal spot usually white; cilia silvery white beyond ill-defined cilia-line. Hindwing (fig. 12) with yellowish brown hair-pencil of approximately  $\frac{1}{3}$  hindwing length, surrounded by white lamellar scales; humeral lobe prominent, costal margin distinctly emarginated beyond hair-pencil.

Female. Forewing length 3.32—3.92 mm ( $3.67 \pm 0.19$ , 10), wingspan 7.2—8.6 mm. Antennal segments 40—42 ( $41.2 \pm 0.8$ , 5).

Male genitalia (figs. 91, 331). Capsule length 364—424  $\mu\text{m}$  ( $388 \pm 19.4$ , 15), wider than in *atrifrontella*, width 308—356  $\mu\text{m}$ . Vinculum with posterior part of ventral plate about half as long as ventral plate. Tegumen slightly cuspidate. Gnathos (fig. 283) with central element long and narrow, parallel-sided. Valva (fig. 233) length 279—321  $\mu\text{m}$  ( $299.7 \pm 13.5$ , 15), triangular, with indistinct rounded mesal lobe basally, not projecting beyond inner margin; transtilla with long ventral arm. Aedeagus (figs. 339, 340, 347) 343—403  $\mu\text{m}$  ( $435.7 \pm 19.1$ , 15), not constricted; ventral carinae long, but shorter than in *atrifrontella*, not serrate; lateral and dorsal carinae not connected by rim, stout and pointed; dorsal carinae often bi- or multifurcate, with up to four horns each. Vesica with egg-shaped sclerotised plate in addition to small cornuti.

Female genitalia (figs. 147, 148, 423). T8 with many long hairs, a row of more than 20 thicker and very long setae along anterior margin, scales absent; anterior margin of T8 almost straight, slightly indented. Anal papillae with 7—12 setae. Posterior apophyses reaching distinctly beyond anterior apophyses. Vestibulum with pair of indistinct sclerotisations. Corpus bursae 1050—1450  $\mu\text{m}$ , covered with pectinations, partly in concentric bands around signa; signa elongate, similar, length 440—737  $\mu\text{m}$  ( $562 \pm 77$



$\mu\text{m}$ , 16), 4.0—5.2  $\times$  as long as wide. Ductus spermathecae with  $3\frac{1}{2}$ — $3\frac{3}{4}$  convolutions.

Larva not examined.

#### Biology.

Host plants: *Quercus robur* L. and probably other *Quercus* species. Mines on *Castanea* could also belong to this species. In fact only reared once by Schönherr (1958), but mistaken for *atrifrontella*.

Mine. Not described, but probably not different from that of *atrifrontella*.

Life history. Under the name *atrifrontella*, Schönherr (1958) reported a two year cycle for this species — this is analogous to *liebwerdella*. Adults are frequently collected at light in the months June and July, in Yugoslavia also in May, and occasionally in early August, thus not occurring as late as *atrifrontella*.

#### Distribution (fig. 516).

Widely distributed in central and southern Europe, but absent from Britain, and in Scandinavia only known from southern Sweden. Not yet recorded from Portugal, Switzerland, Czechoslovakia, Bulgaria and Greece, but occurring in Anatolia.

#### Remarks.

This species was described from a long series covering many localities. Klimesch did not specify a holotype, but the identity of this species is clearly understood from his description and figure. Although I did not study the syntypes, I select here the specimen of which the genitalia were figured by Klimesch, as lectotype, and therefore restrict the type locality to Nagy Nyir near Kecskemét, which also was listed as first locality in Klimesch's list.

Although I was not able to examine *Stigmella* (*Fomoria*) *peiuii* Nemes, from the description and figure of male genitalia there is little doubt it is a synonym of *longicaudella*.

Material examined: 40  $\delta$ , 13  $\text{♀}$ , 1 ex. — Austria: 2  $\delta$ , Gumpoldskirchen, Glaslatterriegel, 4.vii.1976, 18.vii.1980, F. Kasy; 8  $\delta$ , Hackelsberg N. of Neusiedlersee (near Jois), 23.vi.1975, 24.vi.1977 and 2.vii.1977, F. Kasy; 2  $\delta$ , Hundsheimer Berg, Porta Hungarica (near Hainburg), 28.vi.1976, 2.vii.1977, F. Kasy (NMW). — Belgium: 1  $\text{♀}$ , Aye, 4.vii.1946, A. Richard; 2  $\text{♀}$ , Aye, 27.vii.1949, E. Janmouille (IRSN). — France: 1  $\delta$ , 1  $\text{♀}$ , "Antarv." (? near Digne), 18.vii.1903, Chrétien; 3  $\delta$ , Célé (Lot), 24—26 [= decades?], C. Dumont; 2  $\delta$ , 1  $\text{♀}$ , Digne, vii—viii.1903, Chrétien; 3  $\delta$ , Nay, vi.1906, 9.vii.1912 and

16.vi.1917, Chrétien; 1  $\delta$ , 2  $\text{♀}$ , Revent. (interpreted as Reventin-Vaugris), 12—27.vii.1902, Chrétien (MNHN); 2  $\delta$ , 1  $\text{♀}$ , St. Barnabé, Col de Vence (Alpes Marit.), 900 m, 2—7.vii.1962, Arenberger (LNK); 1  $\delta$ , Viens (Vaucluse) (near Apt), 10.viii.1974, R. Buvat (coll. Buvat). — Germany, East: 1  $\text{♀}$ , Tharandt, e.l. 9.vii.1956, *Quercus robur*, J. Schönherr (MHUB). — Hungary, 1  $\delta$ , Budakeszi, Hársbokorh., 24.vii.1952, L. Gozmány (MHUB); 1  $\delta$ , Cserkut near Pécs, 12—20.vi.1936, J. Klimesch (LNK); 1 ex., Hu Nyírség, Bátorliget, 14.vi.1949, Kaszab & Székessy (MHUB); 1  $\delta$ , Kunadacs, 10.vi.1958, L. Kovács (TMAB). — Netherlands: 4  $\delta$ , Nijmegen, 14.vii.1926, 21.vii.1929, and 11.vii.1932. Lycklama à Nyeoholt (RMNH, ZMA). — Spain: 4  $\delta$ , 3  $\text{♀}$ , San Ildelfonso (La Granja), 8.vii.1902, Chrétien (MNHN). — Sweden: 3  $\delta$ , Högsby (Sm.), 17.vii.1976, R. Johansson (BMNH, EvN). — Turkey: 1  $\delta$ , Anatolia, Kizilcahamam, 20.vi—8.vii.1970, Pinker (LNK). — Yugoslavia: 1  $\text{♀}$ , Macedonia, Matka, Treschka Schlucht, 19—29.v.1955, J. Klimesch (ZSMK).

Additional records. — Italy: Latina, Monti Aurunci, R. Johansson; Piemonte, Rocciamelone, 800 m, 8.vii.1961, at light, E. Jäckh (both R. Johansson, pers. comm.).

#### 4. *Ectoedemia* (*Zimmermannia*) *hispanica*

sp. n.

(figs. 39, 92, 234, 284, 332, 344, 345, 517)

Type material: Holotype  $\delta$ , Spain: Andalucía, Sierra de Marbella, El Mirador, 700 m, 14.vii.1980, E. Traugott-Olsen, Genitalia slide VU 1931 (ZMC). Paratype  $\delta$ , Spain: Aragon, Rubielos de Mora, 4.vii.1967, Arenberger (LNK).

Diagnosis: male genitalia very characteristic with the pronounced lobe along inner margin of valva and broad and stout gnathos. Aedeagus similar to *longicaudella*. Externally characterised by inconspicuous costal emargination and short hair-pencil.

#### Description.

Male (fig. 39). Forewing length 2.88—3.08 mm, wingspan 6.2—6.8 mm. Head: frontal tuft fuscous to dark brown. Antennae long, with 50—56 segments. Colour of thorax not unequivocal to determine (worn specimens). Forewings brown, probably uniformly coloured. Hindwing with relatively short white hair-pencil, about  $\frac{1}{4}$  of hindwing length, surrounded by some white lamellar scales; humeral lobe less pronounced than in previous species, costal emargination very inconspicuous.

Female unknown.



Male genitalia (figs. 92, 332). Capsule length 334—374  $\mu\text{m}$ . Tegumen extended into rounded pseuduncus. Gnathos (fig. 284) with central element wide and truncate. Valva (fig. 234) length 270—279  $\mu\text{m}$ , triangular, with prominent inner lobe in middle of valva; transtilla with long ventral arm. Aedeagus (figs. 344, 345) 377  $\mu\text{m}$ , slightly constricted in middle; ventral carinae long, as in *longicaudella*, not serrate; lateral and dorsal carinae not connected by rim, stout and pointed; dorsal carinae sometimes bifurcate.

Larva unknown.

#### Biology.

Hostplant unknown. There are in the type-locality some large old *Castanea* trees and *Quercus suber*, but a search for barkmines in February 1984 was not successful. Adults have been caught in July.

Distribution (fig. 517).

East and South Spain.

#### Remarks.

This species seems closely related to *E. longicaudella*, but the male genitalia and hair-pencil are different enough to justify describing a new species.

### 5. *Ectoedemia (Zimmermannia) monemvasiae* sp. n.

(figs. 13, 31, 32, 40, 93, 149, 150, 235, 285, 333, 349, 351, 352, 424, 538)

Type material: Holotype  $\delta$ , Greece (Hellas): Lakonia, 5 km s. Monemvasia, 28.vii.1979, G. Christensen, Genitalia slide VU 468 (ZMC). Paratypes: 5  $\delta$ , 4  $\text{f}$ . — Greece: 1  $\text{f}$ , Lakonia, 5 km s. Monemvasia, 1.viii.1978, G. Christensen; 2  $\text{f}$ , same data, but 28.vii.1979; 1  $\delta$ , same data, but 8.viii.1979; 1  $\delta$ , Lakonia, 7 km sw. Monemvasia, 4.viii.1979, G. Christensen; 1  $\text{f}$ , same data, but 25.vii.1980; 1  $\delta$ , same data, but 8.viii.1980 (ZMC, ZMA). — Turkey: 2  $\delta$ , Anatolia, Kizilcahamam, 200 m, 31.vii—1.viii.1963, Arenberger (LNK).

Other material: Greece, 1  $\text{f}$  (abdomen and metathorax missing), Lakonia, 7 km sw Monemvasia, 10.vii.1980, G. Christensen (ZMC).

Diagnosis: male distinguished from the other *Zimmermannia* species treated here, by long brownish hair-pencil, surrounded by dark brown lamellar scales. Female by very dense bunch of long setae on abdominal tip dorsally. Male genitalia diagnosed by shape of vinculum, slender valvae with inner lobe, configuration of

carinae and triangular cornutus and female genitalia by number of convolutions in ductus spermathecae and hairy T8 and T9.

#### Description.

Male. Forewing length 2.84—3.36 mm ( $3.05 \pm 0.19$ , 5), wingspan 6.5—7.5 mm. Head: frontal tuft and collar fuscous. Antennae very long, with 49—58 segments ( $53.2 \pm 3.7$ , 5). Thorax and forewings brown, irrorate with white, sometimes an inconspicuous tornal spot white; cilia white beyond ill-defined cilia-line. Hindwing (fig. 13) with long brown hair-pencil, almost half as long as hindwing, surrounded by field of dark brown lamellar scales; humeral lobe prominent, costal margin with distinct emargination beyond hair-pencil.

Female (fig. 40). Forewing length 2.6—3.0 mm ( $2.83 \pm 0.15$ , 5), wingspan 6.5—7 mm. Antennal segments 42—44 ( $43.3 \pm 1.0$ , 4).

Male genitalia (figs. 93, 333). Capsule length 386—429  $\mu\text{m}$  (3). Vinculum with ventral plate short, slightly excavate. Tegumen produced into blunt pseuduncus. Gnathos (fig. 285) with central element long and narrow, tapering towards sharp point. Valva (fig. 235) length 303—343  $\mu\text{m}$  (3), narrow triangular, with prominent inner lobe in middle of valva; transtilla with very long ventral arm. Aedeagus (figs. 349, 351, 352) 437—467  $\mu\text{m}$  (3), slightly constricted near opening of ductus ejaculatorius; ventral carinae long and parallel, fused near tip; lateral carinae small, almost triangular; dorsal carinae palmate, comprising each 4—5 teeth. Vesica with stout pointed triangular cornutus in addition to numerous small cornuti.

Female genitalia (figs. 31, 149, 150, 424). Along anterior margin of T8 (? partly on T7) crescent shaped bundle of more than 50 very long setae, easily visible in undissected material, setae pectinate (fig. 32), on rest of T8 many short setae, scales absent. Anal papillae with more than 30 setae. Posterior apophyses reaching beyond anterior apophyses. Vestibulum wide, without distinct sclerotisations. Corpus bursae 1040—1080  $\mu\text{m}$ , covered with pectinations, partly in concentric bands around signa; signa elongate, slightly dissimilar, shortest 484—506  $\mu\text{m}$ , largest 583—616  $\mu\text{m}$ . Ductus spermathecae with  $4\frac{1}{2}$ —5 convolutions.

Larva unknown.

#### Biology.

Hostplant: unknown, possibly a barkminer on Fagaceae.

Life history. Adults have been taken in July and early August.

Distribution (fig. 538).

Greece: Peloponnesos and Turkey: Anatolia.

Remarks.

This is a very distinctive species, of which several specimens of both sexes were collected from the type locality. The remarkably hairy abdominal tip of the female and the pectinate setae, suggest that this species lays its eggs on a very rough surface, such as old rugose bark.

6. *Ectoedemia* (*Zimmermannia*) *amani* Svensson, 1966

(figs. 14, 41, 94, 151, 152, 236, 286, 334, 341, 342, 350, 425, 472, 474, 517)

*Ectoedemia amani* Svensson, 1966: 200, 201, fig. 34, pl. 4 fig. 3. Holotype ♂, Sweden: Sdm., Saltsjöbaden, 3.vii.1958, E. Aman, Genitalia slide 4107 (RMS) [examined].

*Ectoedemia amani*; Borkowski, 1975: 497, fig. 5 (♂ genitalia).

*Trifurcula* (*Ectoedemia*) *amani*; Johansson, 1971: 245.

*Trifurcula amani*; Larsen, 1981: 71, 72, figs. 1—4 (♂, ♀ genitalia, distribution).

Diagnosis: largest *Ectoedemia* from Europe, distinguished form preceding five species by orange head, absence of white spots on forewing and lower number of antennal segments. Differs from externally similar, but lighter, *liguricella*, by presence of hair-pencil in male and lower number of antennal segments, in both sexes. Male genitalia characteristic with short and wide aedeagus, configuration of carinae and broad triangular valvae. Female genitalia especially characterised by long spiraled ductus spermathecae, absence of long hairs on T8 and spines in vestibulum.

Description.

Male. Forewing length 3.2—3.92 mm (3.72 ± 0.15, 6), wingspan 7.8—8.8 mm. Head: frontal tuft and collar orange to ochreous. Antennae not very long, with 36—41 segments (3). Thorax and forewing uniformly brown irrorate with white, without white spots; cilia lighter but cilia-line very inconspicuous. Hindwing (fig. 14) with snowwhite hair-pencil, approximately 1/3 of hindwing length, with a row of white scales along costal margin, but no specialised scales along dorsal edge; humeral lobe prominent, costal emargination present beyond hair-pencil.

Female (fig. 41). Forewing length 3.84—4.52 mm (3), wingspan 8.8—9.8 mm. Antennal segments 36—37 (3).

Male genitalia (figs. 94, 334). Capsule length ± 420 μm (2), capsule very wide, 369—373 μm (2). Vinculum with very short ventral plate. Tegumen broadly rounded, not produced. Gnathos (fig. 286) with wide triangular central element. Valva (fig. 236) length 270—280 μm (2), triangular, comparatively wide, tip curved slightly inwards, dorsal surface with indistinct serrate lobe. Aedeagus (figs. 341, 342, 350) 369—420 μm (5), gradually widening from anterior end towards wide posterior end; ventral carinae broadly triangular, separated, inner margin serrate; lateral carinae indistinct, rounded; dorsal carinae comprising a row of 4—5 teeth; surface of aedeagus between ventral and lateral carinae with minute spines. Vesica with one broad triangular cornutus in addition to numerous small cornuti.

Female genitalia (figs. 151, 152, 425, 472). T8 with a row of 16—18 setae along anterior margin and 4—10 small setae on disc, scales absent. Anal papillae with 15—21 setae. Posterior apophyses clearly reaching beyond anterior apophyses. Vestibulum with two groups of spines, one near opening of ductus spermathecae and one opposite (fig. 472). Corpus bursae 1430—1640 μm, covered with pectinations, partly in concentric bands around signa; signa similar, 527—594 μm (4) long, ± 4 × as long as wide. Ductus spermathecae with 12½—13 convolutions.

Larva. Yellow, very elongate. Head-capsule brown. Ventral plates absent.

Biology.

Host plant: *Ulmus* spp. The species has not been reared, but often caught on Elm on which barkmines were observed (Johansson, pers. comm., Larsen, 1981).

Mine (fig. 474). A long contorted gallery in smooth bark of rather thin branches, similar to that of *atrifrontella*.

Life history. Not studied, but probably similar to that of *liebwerdella*. Adults have been caught in June (southern Europe only) and July.

Distribution (fig. 517).

Recorded from southern Norway (see below, not on map), southern Sweden, Denmark: Bornholm and Falster, Austria: Vienna region, and Yugoslavia: Macedonia.

## Remarks.

Although one of the largest nepticulid species, *E. amani* was only discovered in 1966 by Svensson in Sweden. Since then several specimens have been found in Sweden and Denmark (Larsen, 1981). Outside Scandinavia only the four specimens cited below are at present known, plus the larva and mines found near Bad Deutsch Altenburg. This species resembles *E. piperella* Wilkinson & Newton, 1981 from USA.

Material examined: 8 ♂, 4 ♀. — Austria: 1 ♂, Hundsheimer Berg, Porta Hungarica (near Hainburg), 23.vii.1977, F. Kasy; 1 ♂, Klosterneuburg, Kritzendorfer Au, 29.vi.1936, a.l., Preissecker (NMW). — Sweden: 1 ♂ Holotype, see above; 2 ♂, 2 ♀, Kullaberg (Sk.), 19.vii.1974, 11—12.vii.1975, R. Johansson (BMNH, EvN); 2 ♂, Stockholm, Skogskyrkogd, 4.vii.1973, B. Gustafsson; 1 ♂, Upland, Riksmuseet, 10.vii.1973, B. Gustafsson (RMS). — Yugoslavia: 1 ♀, Macedonia, Stari Dojran, 10—19.vi.1955, J. Klimesch (ZSMK); 1 ♀, Macedonia, Treschka Schlucht near Skopje, 1—8.vii, F. Kasy (NMW).

Larva and mines. — Austria; 1 final instar larva, mines, Bad Deutsch Altenburg, W. of Hainburg, Pfaffenberg, 23.x.1983, E. J. van Nieukerken (ZMA).

Additional record. — Norway; Ak., Baerum, Ostoya, 1 ♂, 2—9.vii.1983 (Johansson, in litt.).

7. *Ectoedemia (Zimmermannia) nuristanica*

sp. n.

(figs. 42, 95, 153, 154, 237, 287, 335, 353—355, 426)

Type material: Holotype ♂, Afghanistan: Nuristan, 25 km N. Barikot, 1800 m, 12—17.vii.1963, Kasy & Vartian, Genitalia slide MV 5402 (NMW). Paratype ♀, same data (NMW).

Diagnosis: the only known dark-headed (Palaearctic) *Zimmermannia* without hair-pencil in male. Male genitalia characterised by pointed pseuduncus, narrow valvae and three pairs of almost similar carinae. Female characterised by very dense bundle of extremely long setae on tergite 7.

## Description.

Male holotype (fig. 42). Forewing length 2.84 mm, wingspan 6.4 mm. Head: frontal tuft and collar dark brown. Antennae broken. Thorax and forewings brown irrorate with white, with an inconspicuous white dorsal spot. Hindwing without hair-pencil, costal bristles or specialised scales; humeral lobe more or less distinct.

Female paratype. Forewing length 3.08 mm,

wingspan 7 mm. Antennae long, with 41 segments.

Male genitalia (figs. 95, 335). Capsule length 403 µm, width 261 µm. Tegumen produced into cuspidate pseuduncus. Gnathos (fig. 287) with long, slender central element (in figure not in proper ventral view). Valva (fig. 237) length 266 µm, narrow triangular, with indistinct inner lobe (mesal), distally suddenly narrowed into fingerlike tip. Aedeagus (figs. 353—355) 351 µm, hardly constricted; ventral carinae short, widely separate, bifurcate; lateral and dorsal carinae similar in size and shape, horn-shaped, closely placed. Vesica difficult to study in holotype, no special cornuti visible.

Female genitalia (figs. 153, 154, 426). T7 with horseshoe-shaped dense bundle of extremely long setae, reaching beyond abdominal tip. T8 with a row of about 20 long setae along anterior margin and with many shorter setae on disc. Anal papillae with 30—32 setae. Posterior apophyses hardly reaching beyond anterior apophyses. Vestibulum with indistinct sclerotisation. Corpus bursae 935 µm long, covered with pectinations, partly in concentric bands around signa; signa similar, 399 and 424 µm long, 4.5—4.65 × as long as wide. Ductus spermathecae with 4½ convolutions.

Larva unknown.

## Biology.

Hostplant: unknown. The specimens were taken at light in mountains with extensive woods of *Quercus baloot* Griff., a relative of *Q. ilex* L. (Kasy, 1965), it is therefore possible that *nuristanica* is a barkminer of *Q. baloot*.

Life history. Adults taken in July.

## Distribution.

Only known from East Afghanistan: Nuristan.

## Remarks.

It is assumed that both sexes described here belong to the same species, since they are externally similar and have been collected together.

8. *Ectoedemia (Zimmermannia) liguricella*

Klimesch, 1953

(figs. 43, 96, 155, 156, 238, 288, 336, 356—358, 427, 428, 539)

*Ectoedemia liguricella* Klimesch, 1953: 194, 195, figs. 20—22. Lectotype ♂ (here designated), Italy: Liguria, prov. Savona, Noli, v or ix.1951, J. Kli-



mesch, Genitalia slide Kl. 513 (ZSMK) [not examined, genitalia figured by Klimesch].  
*Ectoedemia liguricella*; Szócs, 1965: 49.

Diagnosis: differs from all treated *Zimmermannia* species, except *amani*, by light coloured head. Males can be separated from *amani* by absence of hair-pencil, and females by larger number of antennal segments. Diagnostic in male genitalia are the vinculum process, the short narrow gnathos, the shape of the valva and the configuration of the carinae. The female genitalia are characterised by the relatively few setae on T8 and the  $4\frac{1}{2}$ — $5\frac{1}{2}$  convolutions of the ductus spermathecae. *E. liguricella* can be confused with *Trifurcula* species, see generic diagnosis.

#### Description.

Male (fig. 43). Forewing length 3.0—4.04 mm ( $3.58 \pm 0.29$ , 12), wingspan 7.6—8.8 mm. Head: frontal tuft and collar yellow to yellow ochreous. Antennae long, with 43—48 segments ( $44.9 \pm 1.7$ , 7). Thorax and forewings brown irrorate with yellowish-white (European specimens darker than Moroccan), with sometimes small indistinct white tornal spot; cilia-line hardly visible. Hindwing without hair-pencil, costal bristles or special scales. Humeral lobe distinct, rounded.

Female. Forewing length 3.44—4.0 mm ( $3.73 \pm 0.24$ , 6), wingspan 7.6—9 mm. Antennal segments 39—44 ( $41.6 \pm 2.9$ , 7).

Male genitalia (figs. 96, 336). Capsule length 321—377  $\mu\text{m}$  ( $357 \pm 20.4$ , 10). Vinculum with ventral plate narrow. Tegumen rounded, with an obvious anteriorly directed, tongue-shaped process. Gnathos (fig. 288) with narrow pointed central element, shorter than in related species. Valva (fig. 238) length 270—304  $\mu\text{m}$  ( $284.8 \pm 12.7$ , 9), narrow triangular, with distinct inner (mesal) lobe in middle; transtillae with short transverse bar. Aedeagus (figs. 356—358) 369—420  $\mu\text{m}$  ( $398.1 \pm 16.7$ , 10), slightly constricted; ventral carinae long, widely separate, pointing outwards; lateral carinae absent; dorsal carinae simple, pointed; aedeagus dorsally ending in two weakly sclerotised lobes covered with spines, less spines on left lobe. Vesica with small cornuti only.

Female genitalia (figs. 155, 156, 427, 428). T8 with a row of about 10—20 relatively long setae, along anterior margin, and with a row of 10—20 shorter setae more posteriorly, scales absent. Anal papillae with 15—27 setae. Posterior

or apophyses reaching beyond anterior apophyses. Vestibulum with indistinct internal sclerotisation. Corpus bursae 880—1100  $\mu\text{m}$ , covered with pectinations, especially dense in ductus bursae, partly in concentric bands around signa; signa similar, 308—493  $\mu\text{m}$  ( $395.9 \pm 59.4$ , 8),  $5.5$ — $7.0 \times$  as long as wide. Ductus spermathecae with  $4\frac{1}{2}$ — $5\frac{1}{2}$  convolutions.

Larva unknown.

#### Biology.

Hostplant: unknown. It might be a barkminer of evergreen *Quercus*, since it has often been collected amongst those trees. In one of the localities near Marbella I noted a few barkmines on *Quercus coccifera*, which could belong to *E. liguricella*.

Life history. Adults taken from May to September.

#### Distribution (fig. 539).

A western mediterranean species, known from the Italian Riviera, France, Spain and Morocco. Occurs from sea-level to high elevations in the mountains (1600 m in Spain, 2600 m in Morocco).

#### Remarks.

I have not examined any types of *liguricella*, because the identity of this species is clear from Klimesch's (1953) figure of the male genitalia, and hence, the specimen represented by that figure is here selected as lectotype. For the first time the species is here recorded from areas outside the type-locality.

The female collected in the company of 6 males in Morocco has slightly different genitalia (fig. 428) from the Spanish specimens, and is therefore not included in the measurements of the female genitalia. It has 80 setae along the anterior margin of T8, 45 setae more posterior on T8 and anal papillae with 39 setae. The bursa is smaller, 715  $\mu\text{m}$ , with signa of 283 and 317  $\mu\text{m}$ . The total appearance of the specimen however, does not indicate that it is a different species, but more material is needed to see if this variation is constant.

Material examined: 39  $\sigma$ , 21  $\text{f}$ . — France: 2  $\sigma$ , "Nesp." (? near St. Pons, dep. Hérault), 15.vi.1904, Chrétien; 1  $\sigma$ , Ile du Levant (Var), 19.vii.1941, H. Legrand (MNH). — Morocco: 6  $\sigma$ , 1  $\text{f}$ , Haut Atlas, Oukaim'den (near Toubqual), 2600 m, 9—11.vii.1975, F. Kasy (NMW). — Spain: 1  $\sigma$ , Albarra-cin, Noguera, 1600 m, 18—22.vii.1960, Vartian (NMW); 3  $\sigma$ , Andalucía, road to Benahavis,

8.vi.1983, E. Traugott-Olsen; 1 ♀, Andalucía, road to Casares, 500 m, 9.vii.1973, E. Traugott-Olsen; 2 ♂, 4 ♀, Andalucía (Marbella-region), road to Istan, 400 m, data: 17.vii.1971, 21.vii.1972, 4.vii.1973, 25.vi.1975, 15.vii.1982, E. Traugott-Olsen; 2 ♂, 6 ♀, Andalucía (Marbella-region), road to Ojen, 150 m, data: 5.v.1980, 12 and 25.vi.1981, 20 and 25.vi.1983, E. Traugott-Olsen; 1 ♀, Andalucía (Marbella-region), Refugio de Juanar, 700 m, 29.vii.1971, E. Traugott-Olsen, 2 ♂, 1 ♀, Andalucía, Sierra de Marbella, El Mirador, 700 m, 21.vii.1982, E. Traugott-Olsen (ETO, ZMA, ZMC, EvN); 1 ♂, Andalucía (Granada), Sierra de Alfacar, 1200 m, 26.vi—8.vii.1962, W. Glaser (LNK); 1 ♀, idem, 1500 m, 23.vi.1968, K. Sattler & D. J. Carter (BMNH); 1 ♂, Aragón, Rubielos de Mora, 4.vii.1967, Arenberger; 2 ♂, 5 ♀, Cataluña, Port Bou, 11—18.vii.1967, Arenberger; 3 ♂, idem, 0—300 m, 9—24.vi.1964, M. & W. Glaser (LNK); 1 ♂, Huelva prov., Torre la Higuera, 12.v.1981, C. Gielis (coll. Gielis); 12 ♂, 1 ♀, idem, 22.iv—9.v.1983, J. B. Wolschrijn (coll. Wolschrijn, ZMA, EvN).

### Subgenus *Ectoedemia* Busck

*Ectoedemia* Busck, 1907: 97. Type-species: *Ectoedemia populella* Busck, 1907: 98; by original designation and monotypy.

*Dechthiria* Beirne, 1945: 204. Type-species: *Tinea subbimaculella* Haworth, 1828: 583; by original designation. (Synonymised by Svensson, 1966: 200).

*Ectoedemia* (*Dechthiria*); Borkowski, 1972: 699; Emmet, 1976: 188, 191.

*Ectoedemia* (*Ectoedemia*); Borkowski, 1972: 699; Emmet, 1976: 188, 189; Scoble, 1983: 20.

*Ectoedemia*; Scoble, 1978: 82; 1979: 35—54; Wilkinson & Scoble, 1979: 73; Wilkinson & Newton, 1981: 32 partim.

*Trifurcula* (*Ectoedemia*); Johansson, 1971: 245.

### Description.

Adult. Small to moderately large nepticulid moths, forewing length 1.7—3.7 mm (wingspan 3.2—8.4 mm).

Head. Antennae short or long; in male with 24—63 segments, in female with 21—43.

Wings. Colour pattern variable, often a white medial fascia or costal and dorsal spots present, sometimes basal or discal spot in addition, sometimes white markings absent. Cilia-line present except in *occultella*-group and *populella*. Hindwing in male either with costal bristles or hair-pencil, in some species both absent. Additional special scales occur in several species. Humeral lobe not very prominent, or absent.

Forewing venation (fig. 9). R and M + Cu forming closed cell, branches R<sub>1</sub>, R<sub>2+3</sub>, R<sub>4</sub>, R<sub>5</sub>, M and Cu present. A thickened, without anal loop. Cu and A in some species very long, seeming fused at tips.

Male genitalia. Vinculum ring shaped, anterior extension short, anteriorly convex. Tegumen produced into distinct pseuduncus, of variable form. Uncus absent. Gnathos with spatulate or triangular central element, sometimes divided into a distal spatulate part and basal part with serrate margins. Valva approximately triangular, or almost rectangular, with tip directed inwards or posteriorly, often clearly separate from rest of valva. No mesal (inner) lobes present. Aedeagus in all but one species with ventral carinae, often bi- or multifurcate, and in some species in addition with dorsolateral carinae. Vesica in all but one species with numerous small denticulate cornuti only.

Female genitalia. Tergite 7 with or without a row of long setae near anterior margin of tergite 8. Tergite 8 often with two patches of setae and scales, sometimes with setae only. Anal papillae with setae. Vestibulum in most species with ring-shaped vaginal sclerite and denticulate pouch. Corpus bursae with numerous pectinations, or pectinations concentrated posteriorly near vestibulum. Reticulate signa present, of variable form and often dissimilar. Margin of signa narrower than individual cells. Ductus spermathecae spiraled, with variable number of convolutions.

Larva. Yellow, white, green or grey, feeds venter upwards. Probably all species have four larval instars. Many species have 12 sclerotised ventral plates during second and third instar, being shed in the final instar, independently from moult. In some species similar dorsal plates occur in addition.

### Biology.

Larva leaf-miner, or petiole-miner. Western Palearctic species mine on Fagaceae, Rosaceae, Salicaceae and to a lesser extent on Betulaceae, Ulmaceae and Anacardiaceae. In addition species from other regions are recorded from Nysaceae, Platanaceae, Juglandaceae, Aceraceae, Hippocastanaceae, Ericaceae, Caprifoliaceae and Bursaceae. Most European species are univoltine, feeding in late summer or autumn, but at least *terebinthivora* is bivoltine, and some others are suspected to be so. Larvae of many species are often gregarious. Larvae overwinter full-fed in cocoons in the soil, or in the mine in the case of *agrimoniae* and pupate in spring. Adults emerge in March—July. Some mediterranean species, on evergreen oaks, feed in the winter and aestivate in their cocoons, or emerge in spring.

### Distribution and composition.

The distribution is mainly Holarctic: 42 species are reported here from the West Palaearctic, Wilkinson & Newton (1981) and Wilkinson (1981) reported 18 North American species, Puplessis (1984a and b) described 9 species from the eastern USSR and about 25 species occur in a collection of Japanese Nepticulidae. In addition three species are known from Southern Africa (Scoble, 1978; 1979).

### The *Ectoedemia populella* group

This group comprises all the Salicaceae-feeding *Ectoedemia* species. Most make mines in the petiole and later in the lamina of *Populus* species, *intimella* makes a similar mine on *Salix* but starts in the midrib, not the petiole, and the Nearctic *populella* makes a petiole-gall. All feed late in the year and are often found in the green islands of fallen leaves. Adults are often found resting on trunks.

Male genitalia are characterised by the presence of two pairs of carinae, which are often large.

Female genitalia are characterised by the presence of a vaginal sclerite, a spiculate pouch with conspicuous and equally spaced spicules and a bursa, usually covered with pectinations (except *intimella*). The ductus spermathecae has 2½—3 convolutions and the signa are elongate and almost similar.

Males invariably possess a hair-pencil on the hindwing.

The group is Holarctic, and comprises also the Nearctic *E. populella* Busck and *E. canutus* Wilkinson & Scoble and the Eastern Palaearctic *E. wilkinsoni* Puplessis, 1984a.

### *Ectoedemia* (*Ectoedemia*) *populella* Busck, 1907

(figs. 98, 240, 360)

*Ectoedemia populella* Busck, 1907: 98.

*Ectoedemia populella*; Borkowski, 1972: 697; Wilkinson & Scoble, 1979: 74—77, figs. 41, 42; Wilkinson & Newton, 1981: 41, figs. 4, 5.

*E. populella* does not occur in the Western Palaearctic Region, but is treated here because it is the type-species of *Ectoedemia*. A full description is given by Wilkinson & Scoble (1979). Some descriptive notes are given in order to compare it with the Western Palaearctic species.

Adult. Antennae very long, with approximately 63 segments in ♂ and 42—43 in ♀. Forewings including cilia uniform cupreous brown,

no cilia-line, hindwing in ♂ with short inconspicuous brown hair-pencil.

Male genitalia (figs. 98, 240, 360). Capsule length ± 390 µm. Tegumen produced into rounded pseuduncus. Gnathos with smooth spatulate, slightly truncate central element. Valva (fig. 240) length ± 215 µm, broad, tip hardly demarcated, with many setae; inner margin slightly sinuous. Aedeagus (fig. 360) ± 380 µm, with long pointed ventral carinae and very similar dorsolateral carinae.

Female genitalia. Terminalia very wide. T7 without row of setae. T8 wide, with two patches of scales and 10 setae at least. Anal papillae with 7—11 setae. Vestibulum with vaginal sclerite, a spiculate pouch with many short, single denticles and a dense patch of pectinations near entrance of ductus spermathecae. Corpus bursae without pectinations; signa comparatively short, ± 270—320 µm, cells very spiny. Ductus spermathecae broken in single slide examined.

### Remarks.

*E. populella* makes petiole-galls in several *Populus*-species. In some characters it is aberrant in comparison with European species such as absence of cilia-line, large number of antennal segments.

Material examined. — USA: 4 ♂, 2 ♀, syntypes, no. 3238, 12—24.v.1884, Poplar (USNM).

### 9. *Ectoedemia* (*Ectoedemia*) *intimella* (Zeller, 1848)

(figs. 9, 44, 97, 157, 158, 239, 289, 359, 429, 477, 520)

*Nepticula intimella* Zeller, 1848: 323. Holotype ♀.

Poland: Głogów (Glogau), Zeller (depository unknown) [not examined].

*Nepticula intimella*; Stainton, 1849: 29; 1854: 299; Herrich-Schäffer, 1855: 356; Frey, 1857: 393, 394; Stainton, 1859: 432; Wocke, 1871: 339; 1874: 102; Nolcken, 1871: 792; Heinemann & Wocke, 1877: 764; Sorhagen, 1886: 309; Meyrick, 1895: 724, 725; Tutt, 1899: 341, 342; Rebel, 1901: 227; Meess, 1910: 480; Sorhagen, 1922: 54, pl. 3 fig. 61; Meyrick, 1928: 861; Petersen, 1930: 74, fig. 110 (♂ genitalia); Hering, 1943: 275, fig. 2 (♂ genitalia); Szöcs, 1965: 82.

*Dechitiria intimella*; Beirne, 1945: 205, fig. 67 (♂ genitalia); Emmet, 1971: 280, 281.

*Stigmella intimella*; Klimesch, 1951: 63, 64; Gerasimov, 1952: 244; Klimesch, 1961: 762; Lhomme, 1963: 1199; Borkowski, 1969: 112.

*Stigmella* (*Dechitiria*) *intimella*; Hering, 1957: 811, 928, fig. 588b (mine).



*Trifurcula (Ectoedemia) intimella*; Johansson, 1971: 245.

*Ectoedemia intimella*; Bradley et al., 1972: 3; Borkowski, 1975: 494; Emmet, 1976: 190, pl. 7 fig. 1, pl. 12 fig. 34; van Nieuwerkerken, 1982: 107.

*Trifurcula intimella*; Karsholt & Nielsen, 1976: 18.

Diagnosis: easily separated from most *Ectoedemia* species by presence of a medial dorsal spot only on forewing. Distinguished from *ilicis* and *heringella* by more uniformly dark forewings, hair-pencil in male, and the flagellum being the same colour as the scape: it is the only treated *Ectoedemia*, with this character. Species of *Fomoria*, *Stigmella* or *Ectoedemia (Zimmermannia)* with dorsal spot only, have it in post-medial position.

#### Description.

Male. Forewing length 2.4—2.84 mm ( $2.58 \pm 0.15$ , 16), wingspan 5.3—6.3 mm. Head: frontal tuft and collar intensively ferruginous to yellowish orange. Antenna with 39—45 segments ( $41.3 \pm 2.0$ , 12), scape, pedicel and flagellum yellowish white, with an orange tinge. Thorax and forewings uniformly blackish fuscous, with a faint purplish gloss, scales almost uniformly dark; a yellowish white dorsal spot in middle of forewing, conspicuous. Hindwing with a very short ochreous hair-pencil, less than 1/5 of hindwing length.

Female (fig. 44). Forewing length 2.48—3.04 mm ( $2.75 \pm 0.19$ , 7), wingspan 5.6—6.8 mm. Antenna with 27—30 segments ( $28 \pm 1.1$ , 6). Ovipositor protruding, pointed.

Male genitalia (figs. 97, 239, 289, 359). Capsule length 287—304  $\mu\text{m}$  ( $294.3 \pm 8.0$ , 6). Tegumen produced into wide, triangular pseuduncus. Gnathos (fig. 289) with central element very wide, uniformly rounded. Valva (fig. 239) length 210—236  $\mu\text{m}$  ( $217.1 \pm 9.3$ , 6), basally broad, suddenly narrowed in middle with inner margin becoming strongly concave; tip pointed. Aedeagus (fig. 359) 317—364  $\mu\text{m}$  ( $340.3 \pm 18.3$ , 5), with pair of slender, pointed ventral carinae, sometimes bifid, and pair of pointed dorsolateral carinae with additional spines.

Female genitalia (figs. 157, 158, 429). T7 with a row of 6—8 setae along posterior margin. T8 narrowed posteriorly, with two lateral groups of 11—16 short and long setae. Anal papillae narrow, with 14—15 setae. Vestibulum with vaginal sclerite, a dorsal spiculate pouch with comparatively few (less than 40) spines, all single and equally spaced; patch of densely packed

pectinations near opening of ductus spermathecae. Corpus bursae 505—605  $\mu\text{m}$ , without pectinations; signa dissimilar, longest 304—347  $\mu\text{m}$  (4), shortest 257—313  $\mu\text{m}$  (4),  $4.9$ — $5.5 \times$  as long as wide. Ductus spermathecae with  $2\frac{1}{2}$ —3 convolutions.

Larva. Pale yellow. Sternites present on pro- and mesothorax and abdominal segment 10. Ventral plates absent.

#### Biology.

Hostplants. *Salix caprea* L., *S. cinerea* L., *S. pentandra* L., *S. fragilis* L., and *S. phylicifolia* L.

Mine (fig. 477). Egg on upperside, against midrib. Early mine in midrib, later becoming large elongate blotch at one side of midrib, with black frass deposited in two lateral lines, such that larva can pass in between to conceal itself in midrib. Only final instar larva mines in leaf-blade.

Life history. Univoltine. Larvae feed late in the season, from late September until November, often in green islands in fallen leaves. Adults in June and July.

#### Distribution (fig. 520).

Widely distributed in northern, western and central Europe, but not yet recorded from Norway and Ireland. In the south only known from northern Italy, North Yugoslavia and Rumania.

#### Remarks.

There is unfortunately no specimen in the Zeller collection in BMNH, which can be regarded as the holotype. Zeller's description is however very clear, since he amongst others noted the completely yellow antennae, which are very characteristic for *intimella*. Consequently the identity of this species has never been in doubt.

Material examined: 31  $\delta$ , 23  $\eta$ , 1 ex. — Austria: 1  $\delta$ , Hirschdorf, Ob. Öst., e.l. 11.v. 1898, Hauder; 1  $\eta$ , Klosterneuburg, Freiburg, e.l. 28.v.1941, *Salix caprea*, Preisseecker (NMW). — Germany, East: 2  $\delta$ , 1  $\eta$ , Berlin, Finkenkrug, e.l. 27.ii—7.iii.1918, *Salix caprea*, Hering; 1  $\delta$ , 1  $\eta$ , Bredow near Nauen, e.l. 31.v—2.vi.1923, Hering (MHUB); 1  $\delta$ , Görlitz, 24.vi.1884 (NMW); 1  $\delta$ , Rachlau, Schütze (ZSM); 2  $\delta$ , 3  $\eta$ , Rachlau, 1902, *Salix caprea*, Schütze (MHUB). — Great Britain: 2  $\delta$ , 1  $\eta$ , 2 km SE Earls Colne: Chalkney Wood (Essex), e.l. 30.v—16.vi.1980, *Salix caprea*, Bryan, Emmet & van Nieuwerkerken (ZMA). — Netherlands: 1  $\eta$ , Amsterdamse Bos, e.l. 24.vi.1983, *Salix cinerea*, J. Brouwer; 1  $\delta$ , 2  $\eta$ , Ootmarsum: Ageler-

broeck, e.l. 8—12.v.1982, *Salix cinerea*, Andeweg & van Nieukerken; 4 ♂, Rockanje: Voornes Duin, e.l. 17.vi—4.vii.1980, *Salix cinerea*, van Nieukerken; 3 ♂, Schinveld, 29.vi.1975, G. R. Langohr (ZMA); 1 ♀, Zwanewater, 5.vii.1982, Koster (coll. Koster). — Poland: 8 ♂, 5 ♀, 1 ex., Wrocław (Breslau), e.l. iii—iv.1875, *Salix fragilis*, Wocke (MHUB, NMW, RMNH, ZSM); 1 ♂, 1 ♀, Silesia (MHUB). — Switzerland: 1 ♀, St. Gallen, e.l. iv.1915, Müller-Rutz (ZSM). — Yugoslavia: 2 ♂, 3 ♀, Mt. Slavnik, 8 km S. Herpelje-Kozina (Slovenia), ± 900 m, e.l. 10—15.vi.1984, *Salix caprea*, J. J. Boomsma & E. J. van Nieukerken (ZMA).

Mines. On *Salix caprea*: Austria: Nassfeld Pass, SW Hermagor. — Belgium: Zolder. — Great Britain: SE Earls Colne. — Yugoslavia: Mt. Slavnik, S. Herpelje-Kozina. On *Salix cinerea*: Netherlands: Aalsmeer; Amsterdamse Bos; Ootmarsum; Rockanje.

#### 10. *Ectoedemia* (*Ectoedemia*) *hannoverella* (Glitz, 1872)

(figs. 7, 24, 45, 99, 159, 160, 241, 290, 361, 399, 430, 475, 518)

*Nepticula hannoverella* Glitz, 1872: 25, 26. Lectotype ♂ (here designated), Germany: Hannover, Glitz, coll. Staudinger, Genitalia slide 1521 RJ (MHUB) [examined]

*Nepticula hannoverella*; Wocke, 1871: 340; 1874: 103; Heinemann & Wocke, 1877: 766; Rebel, 1901: 227; Meess, 1910: 480; Sorhagen, 1922: 58; Petersen, 1930: 76, fig. 116 (♂ genitalia); Hering, 1935: 7; Szócs, 1965: 85.

*Stigmella hannoverella*; Klimesch, 1951: 64; Gerasimov, 1952: 241; Klimesch, 1961: 763; Lhomme, 1963: 102; Borkowski, 1969: 107.

*Stigmella* (*Dechtiria*) *hannoverella*; Hering, 1957: 811 (mine).

*Trifurcula* (*Ectoedemia*) *hannoverella*; Johansson, 1971: 245.

*Ectoedemia hannoverella*; Borkowski, 1972: fig. 7 (♂ genitalia); 1975: 495; van Nieukerken, 1982: 107, figs. 1, 5 (♂ genitalia, mine).

Diagnosis: externally easy to confuse with *turbidella*, but in female the blunt ovipositor of *hannoverella* separates it immediately from *turbidella*, which has a pointed ovipositor. Males with dark heads always belong to *turbidella*, but light-headed males can only be separated by the genitalia. These are very different in shape of valva, shape and size of carinate processes, and gnathos, which bears spines in *hannoverella*. From other *Ectoedemia* species *hannoverella* and *turbidella* can be separated by the presence of a white discal spot in basal part of forewing and many scattered white scales; males also possess a hair-pencil.

#### Description.

Male (fig. 45). Forewing length 2.4—3.16 mm ( $2.84 \pm 0.21$ , 18), wingspan 5.2—6.8 mm. Head: frontal tuft yellowish orange to light ferruginous; collar slightly lighter. Antennae with 44—53 segments ( $48.8 \pm 2.8$ , 10). Thorax fuscous black with some white scales along frontal margin; forewings fuscous black with a variable pattern of yellowish white spots; usually a medial costal and opposite dorsal spot, sometimes fused by some, more distally placed, scales; basal half with many scattered white scales, often forming a small discal spot halfway between wingbase and costal spot, and a basal spot along dorsal margin. Specimens with almost uniform dark forewings occur. Hindwing with a yellowish-white hair-pencil, about 1/5th of hindwing length.

Female. Forewing length 2.8—3.32 mm ( $3.05 \pm 0.16$ , 14), wingspan 6.2—7.2 mm. Antennae with 29—33 segments ( $30.9 \pm 1.6$ , 9).

Male genitalia (figs. 99, 241, 290, 361, 399). Capsule length 249—309  $\mu\text{m}$  ( $282.9 \pm 20.8$ , 6). Tegumen wide and rounded. Gnathos (fig. 290) with moderately long central element, ventrally with some rows of spines. Valva (fig. 241) length 201—236  $\mu\text{m}$  ( $217.3 \pm 11.8$ , 7), inner margin almost straight, except basally; outer margin strongly convex, widest part beyond middle; apex of valva not separated, hardly curved inwards, forming an almost right angle. Aedeagus (figs. 361, 299) 291—339  $\mu\text{m}$  ( $309.8 \pm 16.2$ , 7), with two pairs almost similar pointed carinae, hardly curved, without additional spines.

Female genitalia (figs. 159, 160, 430). T7 without row of setae. T8 broad, rectangular or trapezoid, with two lateral patches of scales and at least 12—17 setae. Anal papillae with 6—11 setae. Vestibulum strongly folded (heavily stained by chlorazol), with vaginal sclerite, dorsal spiculate pouch with  $\pm 50$  single and equally spaced spines, and a patch of densely packed pectinations near entrance of ductus spermathecae. Corpus bursae long and slender, 660—880  $\mu\text{m}$ , covered with pectinations, partly in concentric bands around signa, absent in anterior part; signa almost similar, 390—480  $\mu\text{m}$  ( $422.1 \pm 26.4$ , 10),  $3.4\text{--}3.7 \times$  as long as wide. Ductus spermathecae with  $2\frac{1}{2}$ —3 convolutions.

Larva. Pale yellow. All thoracic segments and abdominal segments 8—10 with light brown sternites. Ventral plates absent.



## Biology.

Hostplants: *Populus nigra* L. and its hybrids (*P. × canadensis* Moench.)

Mine (fig. 475). Egg deposited on lateral side of petiole, about one centimeter from lamina. Mine first straight gallery in petiole, causing swelling; in final instar larva enters lamina, making elongate blotch, usually between first lateral vein and leaf margin, occasionally between midrib and first lateral vein; frass in two parallel lines, leaving passage for larva, which can withdraw itself in petiole.

Live history. Univoltine. Larvae start feeding early, probably already in July, but feed very slowly; blotches with final instar larvae can be found from late September to November, often in green islands of fallen leaves. Larvae feed usually in the dark. Adults in May and June.

## Distribution (fig. 518).

Only known from a comparatively small area in central Europe, where it is widespread and often abundant. Absent from the British Isles and Scandinavia, but known from Denmark. Only two records from France, and not yet recorded south of the Po valley in Italy or south of the Danube in Yugoslavia. Buszko (in litt.) suggests that the species is expanding its area, on the basis of an increase of records in Poland.

## Remarks.

Since types no longer exist in the Glitz collection in Hannover (Niedersächsisches Landesmuseum), a lectotype is selected from specimens in the Staudinger collection.

Material examined: 66 ♂, 56 ♀. — Austria: 2 ♂, 1 ♀, Klosterneuburg, Kritzenborfer Au, e.l. 11—15.v.1937, 24.iv.1938, Preisseecker (NMW); 1 ♂, Wien, Mann, Zeller coll. (sub *turbidella*) (BMNH); 1 ♀, Wien, Prater, e.l. 10—12.vi.1984, E. J. van Nieukerken (ZMA). — Belgium: 1 ♀, Elewijt, 20.vi.1944, L. Legiest; 1 ♂, Laeken (Brussel), 9.v.1945, L. Legiest (IRSN); 2 ♂, 1 ♀, S. of Rouvreur (Liège), e.l. 26—27.v.1980, Bryan & van Nieukerken (ZMA). — France: 1 ♂, 1 ♀, Alpes Maritimes, Toët s.Var, 10.v.1980, C. Gielis (coll. Gielis). — Germany, West: 1 ♂, Baicrn, 1858 (NMW); 1 ♂, 1 ♀, Grünstadt, Pfalz, Eppelsheim (ZSM); 1 ♂, Hannover, Heinemann (RMNH); 1 ♀, Hannover, (NMW); 2 ♂, 1 ♀ (lecto- and paralectotypes), Hannover, Glitz, coll. Staudinger (MHUB); 2 ♂, 2 ♀, Regensburg, D. O. Hofmann (RMNH); 3 ♂, Regensburg, Frank (ZSM); 1 ♀, Regensburg, 28.v.1885 (NMW); 6 ♂, 3 ♀, Regensburg (MHUB). — Germany, East: 1 ♀, Bautzen,

2.iii.1907 (NMW); 4 ♂, 9 ♀, Berlin-Dahlem, e.l. 28.ii—10.iii.1958, Hering; 5 ♂, 8 ♀, Bredow near Nauen, e.l. 22.iii—16.iv.1924, 1.vii.1923, Hering (MHUB); 1 ♀, Erfurt, e.l. 1884 (RMNH). — Netherlands: 19 ♂, 15 ♀, from following localities: Amsterdamse Bos; Bunde; Geulle; De Lutte; Oostvoorne; Susteren; Winterswijk; Zwanewater (ZMA, coll. Koster). — Poland: 4 ♂, 1 ♀, Wroclaw (Breslau), e.l. iii.1868, iii.1869, [Wocke] (MHUB, ZMA). — Switzerland: 1 ♂, Landquart, e.l. 26.iv.1916, Müller-Rutz (ZSM). — Yugoslavia: 2 ♀, 2 km W of Bezdán (Vojvodina), valley of Danube, e.l. 16—19.vi.1984, J. J. Boomsma & E. J. van Nieukerken (ZMA).

Mines. — Austria: Klosterneuburg; Mühlleiten (Grossenzersdorf). — France: Schirmeck. — Germany, West: Hillesheim. — Italy: Cimoláis. — Netherlands: Amsterdamse Bos; Bunde; Chaam; Dene-kamp; Hilversum; Hoogerheide; Oostvoorne; Ulvenhout; Winterswijk. — Yugoslavia: Bezdán.

11. *Ectoedemia (Ectoedemia) turbidella* (Zeller, 1848)

(figs. 46, 100, 161, 162, 184, 242, 291, 362, 431, 432, 476, 519)

*Nepticula argyropeza* var. *turbidella* Zeller, 1848: 321, 322. Syntypes, Poland: Glogów (Glogau), Zeller (depository unknown) [not examined].

[no genus] *argyropeza*; Herrich-Schäffer, [1853]: pl. 106 figs. 838, 839; [1854]: pl. 114 fig. 930 [misidentification].

*Nepticula argyropezzella* Herrich-Schäffer, 1855: 357. (replacement name for *turbidella* Zeller).

*Nepticula populi-albae* Hering, 1935: 7. Lectotype ♀ (here designated), Germany: Berlin, Tiergarten, 22.ii.1933, M. Hering. *Populus alba*, N 4058, coll. Hypon., M. Hering, Genitalia slide on pin (MHUB) [examined].

*Stigmella marionella* Ford, 1950: 39, fig. Holotype ♂, England: Stanmore, Middlesex, v, L. T. Ford (BMNH) [not examined].

[*Nepticula argyropeza*; Frey, 1857: 398—400, partim, misidentification].

*Nepticula turbidella*; Wocke, 1871: 339; 1874: 103; Heinemann & Wocke, 1877: 766; Sorhagen, 1886: 310; Rebel, 1901: 227; Meess, 1910: 480; Petersen, 1930: 76, fig. 115 (♂ genitalia); Hering, 1935: 7; Szöcs, 1965: 85.

*Stigmella turbidella*; Klimesch, 1951: 64; Gerasimov, 1952: 265, 266; Klimesch, 1961: 762; Lhomme, 1963: 1202.

*Stigmella (Dechtiria) turbidella*; Hering, 1957: 811, fig. 488a (mine).

*Dechtiria turbidella*; Vári, 1950: 182, 184, figs. 9, 10 (♂, ♀ genitalia); Emmet, 1970a: 37—41, figs. (♂ genitalia, mine); 1971: 242, 243.

*Trifurcula (Ectoedemia) turbidella*; Johansson, 1971: 245.

*Ectoedemia turbidella*; Bradley et al., 1972: 3;



Borkowski, 1972: fig. 6 ( $\delta$  genitalia); Emmet, 1976: 189, pl. 12 fig. 36, pl. 7 fig. 2; van Nieukerken, 1982: fig. 2 ( $\delta$  genitalia).

*Trifurcula turbidella*; Karsholt & Nielsen, 1976: 18.

*Stigmella populialbae*; Gerasimov, 1952: 252.

*Ectoedemia populialbae*; Borkowski, 1975: 495.

Diagnosis: see diagnosis of *hannoverella* for the differences between it and *turbidella*. The male genitalia resemble those of *klimeschi*, but can be recognised by the shape of the valva, with tooth-shaped tip in *turbidella*, and the asymmetric aedeagus in *klimeschi*. The female genitalia are very characteristic with the pointed ovipositor, and the long and broad apophyses.

#### Description.

Male. Forewing length 2.8—3.68 mm ( $3.34 \pm 0.21$ , 30), wingspan 6.2—8.4 mm. Head: frontal tuft light yellowish-orange or yellowish ochreous to dark fuscous; collar slightly lighter. Antenna with 46—59 segments ( $54.5 \pm 3.1$ , 23). Thorax blackish fuscous, with scattered white scales and sometimes a white tip; forewings blackish fuscous with a variable pattern of yellowish white spots: usually a medial costal and opposite dorsal spot; basal half with many scattered white scales, often forming a small discal spot halfway between wingbase and costal spot, and a basal spot along dorsal margin, usually giving a lighter appearance than *hannoverella*. Hindwing with a yellowish hair-pencil of about one-fifth of hindwing length.

Female (fig. 46). Forewing length 2.76—3.48 mm ( $3.12 \pm 0.20$ , 29), wingspan 6.0—7.8 mm. Head: frontal tuft yellowish orange, never fuscous. Antennae with 27—32 segments ( $29.3 \pm 1.3$ , 21). Ovipositor very conspicuous, pointed.

Male genitalia (figs. 100, 242, 291, 362). Capsule length 270—347  $\mu\text{m}$  ( $304.3 \pm 23.0$ , 13). Tegumen produced into a widely rounded pseuduncus. Gnathos (fig. 291) with central element short triangular, smooth. Valva (fig. 242) length 193—227  $\mu\text{m}$  ( $210 \pm 9.5$ , 9), widest at base, gradually narrowing; tip inwards curved, tooth-shaped, clearly demarcated from valva. Aedeagus (fig. 362) 369—399  $\mu\text{m}$  ( $377.6 \pm 13.9$ , 10), very long and stout, with two pairs of prominent carinae: ventral pair at extreme posterior tip, basally connected, pointed, single or with two or more tips; dorsolateral pair more anteriorly placed, longer than ventral carinae, strongly curved, dorsally connected, often with additional spines at base, often asymmetrical.

Female genitalia (figs. 161, 162, 184, 431,

432). T7 without row of setae. T8 relatively narrow, tapering posteriorly, with two groups of 6—15 setae (to 20 in Iranian specimens), without or with very few scales. Anal papillae narrow, with 7—12 setae. Anterior apophyses widened in middle, especially in lateral view. Posterior apophyses widening towards anterior end. Vestibulum with vaginal sclerite, a dorsal spiculate pouch with many (about 100) single, equally spaced, spines; and a patch of densely packed pectinations near entrance of ductus bursae. Corpus bursae relatively small, 420—660  $\mu\text{m}$ , covered with small pectinations, except in anterior part, partly in concentric bands around signa; signa slightly dissimilar in length (not in shape), longest 219—283  $\mu\text{m}$  ( $263.6 \pm 23.7$ , 6), shortest 184—266  $\mu\text{m}$  ( $227.9 \pm 29.6$ , 6), 3.3—4.4  $\times$  as long as wide (data for specimens from Iran resp.: long signum 240—334  $\mu\text{m}$ ; short 227—279, 2.7—3.4  $\times$  as long as wide). Ductus spermathecae with 2 $\frac{1}{4}$ —3 convolutions.

Larva. Pale yellow. Sternite on prothorax only. Ventral plates absent. This is the only *Ectoedemia* s.str. species with dorsal as well as ventral calli.

#### Biology.

Hostplants: *Populus alba* L., *P. canescens* (Aiton.) Sm., only on the smaller leaves of older shoots of large trees, never on saplings. Material from Potsdam (leg. Hinneberg) is labelled with "Pop.nigr.", but this is probably incorrect.

Mine (figs. 476). Egg deposited on side of petiole, about 1 $\frac{1}{2}$ —2 cm from leaf base. Mine first straight gallery in petiole, causing swelling; final instar larva makes triangular blotch between first lateral vein and leaf margin, or less often between midrib and first lateral vein; frass deposited in two lateral lines, leaving passage for larva, which can withdraw itself in petiole.

Live history. Univoltine. Larvae start feeding probably in summer, mature larvae can be found in October and November, usually later than *hannoverella*, often in green islands in fallen leaves. The larva usually feeds in the night. Adults in May-June, or April in the South.

#### Distribution (fig. 519).

Widespread. In Scandinavia in southern Sweden and Denmark only, very local in the extreme east of England, locally abundant throughout central Europe. Some scattered records are known from southern Europe: Spain, Sicily. Also in North Iran (see remarks).

## Remarks.

Zeller (1848) described *turbidella* as a variety of *argyropeza*, as follows: "Var. c. major; strigula ex costa prope basim obliqua dorsoque basali albidis, ceterum ut. b. *Turbidella* Z. in lit.". Further (p. 322) he said that he believed it to possibly be a separate species. Unfortunately there is no specimen in the Zeller collection in BMNH that can be identified as a syntype of *turbidella*. His description can, however, only refer to *turbidella* or *hannoverella*. Borkowski (1975) referred to *turbidella* types, examined by Johansson. However, Johansson (verbal comm.) only saw one specimen (genitalia slide BMNH 20537) which actually is *argyropeza*, and was sent by Mann in Vienna to Zeller in 1856, too late to be a *turbidella* syntype. Hence, the synonymy of *turbidella* with *argyropeza* by Borkowski (l.c.) is unjustified. Ever since 1848, *turbidella* Zeller has been used for the species mining on *Populus alba*, with white scales in the basal half of the wing. This is not contradicted by the description, and thus its identity is firmly established. It is therefore not necessary to select a neotype here.

Unfortunately Herrich-Schäffer interchanged the names *turbidella* and *argyropeza*, although he knew exactly what Zeller meant by both names. Thus *turbidella* Herrich-Schäffer is a different species from *turbidella* Zeller, which was named by him first *argyropeza* Herrich-Schäffer (1853) and later *argyropezzella*.

*Nepticula populi-albae* Hering was described on the basis of a different head colour only, but since this is a very variable character, even within one population, it does not justify a separate identity.

The fine series of *turbidella* collected by F. Kasy in Iran, consisting of only females, shows some slight differences from the European form in the genitalia. The most remarkable are that segments 8 and 9 are wider (fig. 432) and there is an oblique, hyaline bar in the vestibulum of all specimens examined (fig. 184). See also the measurements above. A sound taxonomic conclusion about these specimens cannot be made without examination of males from the same region, and preferably a study of the biology. The Iranian population is certainly not parthenogenetic — as in *argyropeza* — for spermatophores were found in several of the bursae examined.

Material examined: 175 ♂, 167 ♀. — Austria: 3 ♀, Hundsheimer Berg (near Hainburg), 15–16.v.1975, F. Kasy; 2 ♀, Klosterneuburg, Kuhau, 11.v.1915 and

14.iii.1938, Preissecker; 1 ♂, Klosterneuburg, Kritzenendorfer Au, 16.iii.1938, Preissecker; 1 ♀, Linz, 2.v.1910, Knitsche (NMW); 1 ♂, 1 ♀, Linz, e.l. iii–iv.1936, Klimesch (NMW, ZMA); 1 ♀, Traun, e.l. 22–30.iii.1936, J. Klimesch (ZMA); 1 ♀, Wien, Prater, 24.iv.1904; 13 ♂, 14 ♀, Wien, Prater, e.l. 4.iv–21.vi.1984, E. J. van Nieukerken (ZMA); 1 ♂, 1 ♀, Wien, Aspern, e.l. 27.v.1934, Koschabek; 1 ♀, Lobau (Wien), 10.v.1908, Zerny (NMW). — Belgium: 3 ♀, Berg, 19.v.1945, L. Legiest; 2 ♂, Jette (Brussel), 28.iv.1945, L. Legiest; 1 ♂, Laeken (Brussel), 13.v.1944, L. Legiest (IRSN). — Denmark: 1 ♂, 1 ♀, Stigsnaes, 23.vi.1955, N. L. Wolff (MHUB). — Germany, West: 3 ♂, 1 ♀, Bavaria, A. Schmid (RMNH); 1 ♂, 3 ♀, Braunschweig, Heinemann (MHUB). — Germany, East: 2 ♂, 1 ♀ (lecto- and paralectotypes *populi-albae*), Berlin, Tiergarten, e.l. 19–22.ii.1933, Hering; 14 ♂, 6 ♀, Berlin, Tiergarten, e.l. iii.1934, Hering; 16 ♂, 27 ♀, Berlin, Botanische Garten, 11–12.iii.1948 and 17–28.ii.1952, Hering (MHUB); 7 ♂, 9 ♀, Potsdam, 28.ii–10.iii.1895, *Pop. nigra* (sic!), Hinneberg (MHUB, ZMA, ZSM). — Great Britain: 2 ♂, 2 ♀, Loughton: Epping Forest, e.l. 10–12.v.1980, Bryan & van Nieukerken (ZMA). — Iran: 10 ♀, Keredj N., 27.iv.1970, Exp. Mus. Vind. (NMW). — Netherlands: 2 ♂, 1 ♀, Leiden, Leidse Hout, e.l. 22–23.iv.1981, E. J. van Nieukerken; 9 ♂, 4 ♀, Oostvoorne, Mildenburg, e.l. 10–20.v.1983, Boomsma & Alders (ZMA); 1 ♂, Oostvoorne, 3.v.1981, Huisman (coll. Huisman); 1 ♂, Oostmaerland, 12.v.1974, G. Langohr, 2 ♂, Overveen, 10.v.1927 and 3.vi.1942, Bentinck; 37 ♂, 17 ♀, Santpoort, 1944–1948, Vári, Helmers, Doets (RMNH, ZMA); 1 ♂, 2 ♀, Santpoort N., Duin- en Kruidberg, e.l. 19.v.1983, Boomsma & Alders; 2 ♂, 2 ♀, Schinveld, 16.v.1976, G. Langohr; 39 ♂, 23 ♀, Wijlre, 19.v.1974 and 22.v.1977, G. Langohr (ZMA). — Poland: 5 ♂, 3 ♀, Wroclaw (Breslau), e.l. iii.1864 [Wocke] (MHUB, RMNH, ZMA); 1 ♀, Wroclaw (Breslau), 19.v.1912 (NMW); 1 ♂, Silesia, Wocke (MHUB). — Spain: 2 ♂, Granada, 21–22.iv.1883, Staudinger (MHUB); 1 ♂, 19 ♀, Teruel, Valde-tormo, 8.v.1978, C. Gielis (coll. Gielis). — Yugoslavia: 6 ♀, 2 km w. of Bezdan (Vojvodina), valley of Danube, e.l. 27.iv.–7.v.1984, J. J. Boomsma & E. J. van Nieukerken (ZMA).

Mines. — Austria: Mühlleiten (Grossenzersdorf); Wien, Prater. — France: Schirmeck. — Great Britain: Loughton, Epping Forest. — Netherlands: Santpoort. — Yugoslavia: Bezdan.

12. *Ectoedemia* (*Ectoedemia*) *klimeschi*

(Skala, 1933)

(figs. 47, 101, 163, 164, 243, 292, 363, 400, 401, 433, 478, 541)

*Nepticula klimeschi* Skala, 1933: 31. Syntypes, Austria: Linz, Donaueuen, *Populus alba*, mines 1931, e.l. 1932, J. Klimesch (ZSMK, MHUB) [examined].

*Stigmella* (*Fomoria*) *niculescui* Nemeş, 1970: 33–35, figs. 1, 2. Holotype ♂, Rumania: Icani (Suceava),



- 16.iv.1966, I. Nemeş, Genitalia slide 1182 (coll. Nemeş) [not examined] **Syn. nov.**  
 [*Nepticula argyropeza*; Petersen, 1930: 78, fig. 122 (♂ genitalia) misidentification].  
*Stigmella klimeschi*; Gerasimov, 1952: 244, 245; Klimesch, 1961: 763.  
*Nepticula klimeschi*; Hering, 1935: 7; Szöcs, 1965: 85.  
*Stigmella (Dechtiria) klimeschi*; Hering, 1957: 811 (mine).  
*Ectoedemia klimeschi*; Borkowski, 1975: 495.

Diagnosis: females are externally almost inseparable from *E. argyropeza*, only the larger number of antennal segments (34—38 in *klimeschi*, 26—32 in *argyropeza*) being diagnostic. Female genitalia can be separated from *argyropeza* by the signa which are longer in *klimeschi*, at least always longer than the shortest signum of *argyropeza*. There is some resemblance to the species of *E. albifasciella*-complex, but the latter have the costal spot always nearer the wing base and lack the hair-pencil in the male. See key for differences with *suberis*.

#### Description.

Male (fig. 47). Forewing length 2.76–3.6 mm ( $3.09 \pm 0.27$ , 12), wingspan 6.0—8.2 mm. Head: frontal tuft and collar yellowish orange. Antennae with 49—58 segments ( $52.8 \pm 3.2$ , 13). Thorax and forewings blackish fuscous, slightly irrorate by lighter scale-bases; a medial dorsal and costal white spot, opposite, usually widely separate; dorsal spot sometimes extending along dorsal margin towards base. Hindwing with yellowish hair-pencil of  $\frac{1}{4}$ — $\frac{1}{5}$  hindwing length.

Female. Forewing length 3.0—3.08 mm ( $3.05 \pm 0.03$ , 5), wingspan 6.7—6.8 mm. Antennae with 34—38 segments ( $35.1 \pm 1.3$ , 15).

Male genitalia (figs. 101, 243, 292, 363, 400, 401). Capsule length 292—321  $\mu\text{m}$  ( $307.7 \pm 11.9$ , 5). Tegumen produced into a widely rounded pseuduncus. Gnathos (fig. 292) with relatively long, triangular central element. Valva (fig. 243) length 214—236  $\mu\text{m}$  ( $226.3 \pm 8.2$ , 5), widest at base, gradually narrowing into triangular tip, not demarcated from valva. Aedeagus (figs. 363, 400, 401) 390—411  $\mu\text{m}$  ( $405.4 \pm 8.9$ , 5), very long and stout, markedly asymmetrical, posteriorly curved at right-hand side; with two pairs of prominent carinae: ventral pair at extreme posterior tip, basally connected, pointed, single; dorsolateral pair more anteriorly placed, longer than ventral carinae, strongly curved, dorsally connected, often with additional spine

at base, which is larger in left process, asymmetrical.

Female genitalia (figs. 163, 164, 433). T7 without row of setae. T8 wide, trapezoid, with two lateral groups of scales and many setae (13—20 at least). Anal papillae with 9–11 setae. Vestibulum with vaginal sclerite, a dorsal spiculate pouch with many (more than 60) single, equally spaced, denticles; and a patch of densely packed pectinations near entrance of ductus spermathecae. Corpus bursae 660—715  $\mu\text{m}$ , covered with small pectinations, partly in concentric bands around signa; signa almost similar, 373—416  $\mu\text{m}$  ( $394.3 \pm 12.5$ , 8), 3.5—4.4  $\times$  as long as wide. Ductus spermathecae with  $2\frac{1}{2}$ —3 convolutions.

Larva. Pale yellow. Prothorax and segment 10 with sternites. Ventral plates absent.

#### Biology.

Hostplant: *Populus alba* L., on saplings and large lobed leaves of young branches on trees. When sympatric with *turbidella*, always on different leaves, but sometimes on the same branch.

Mine. (fig. 478). Egg on petiole, but almost impossible to find, between long hairs. Mine first straight gallery in petiole, causing it to swell. In final instar larva enters leaf, and makes blotch, usually not between veins, but incorporating vein or midrib in middle of mine; frass in two lateral lines, leaving passage for larva, which can withdraw itself in petiole. Sometimes the larva feeds so long in the petiole, that there is hardly a mine in the lamina. *E. klimeschi* does not cause such conspicuous green islands as the related species.

Life history. Univoltine. Larvae probably start feeding in summer, mature larvae can be found in October and November. Adults in June and July.

#### Distribution (fig. 541).

East and Southeast Europe, especially common in Danube basin, from West Germany to Rumania. Also recorded from East Germany, Poland, Switzerland and northern Italy.

#### Remarks.

The types from Skala's collection are lost, but syntypes are still extant in other collections. I have examined syntypes from Berlin, but it would be more appropriate to select a lectotype from Klimesch's collection. Previously this spe-



cies has been confused with *argyropeza*, and probably most records of *argyropeza* males refer in fact to *klimeschi*.

*Stigmella niculescui* Nemeş is undoubtedly a synonym of *klimeschi*, the genitalia figure shows the characteristic valvae. The figure, however, is completely symmetrical, whilst the genitalia are asymmetrical.

This species was previously believed to occur only in the leaves of saplings, but in 1983 we were able to find it also on similarly shaped leaves on large trees. Sometimes they were even found on the same branches as *turbidella*, but always in the lobed leaves.

Material examined: 20 ♂, 19 ♀. — Austria: 1 ♀, Gramatneusiedl, Fürbachwiesen, 11.vi.1982, F. Kasy; 2 ♂, 1 ♀, Hundsheimer Berg (near Hainburg), 13.vi.1979 and 8.vii.1980, F. Kasy; 1 ♂, 1 ♀, Klosterneuburg, Kritzendorfer Au, e.l. 15—16.iv.1938, Preisseecker; 1 ♂, Klosterneuburg, Kuhau, e.l. 19.iv.1937, Preisseecker; 1 ♀, Klosterneuburg, Ziegehofen, e.l. 17.v.1937, Preisseecker (NMW); 1 ♀, Klosterneuburg, Röllföhren, e.l. 19—21.v.1984, J. J. Boomsma & E. J. van Nieukerken (ZMA); 1 ♂, 1 ♀ (syntypes), Linz, Donauauen, e.l. 6.iv.1932, J. Klimesch (MHUB); 4 ♂, 2 ♀, Linz, Donauauen, e.l. 21.iv.—2.v.1934, J. Klimesch (MHUB, NMW); 1 ♂, Linz, 12.v.1974, J. Klimesch; 4 ♂, 1 ♀, Linz, Holzheim, e.l. 3.vi.1980, 30.iv.—12.v.1981, J. Klimesch; 2 ♂, 3 ♀, Wien, Prater, e.l. 15.v.—19.vi.1984, E. J. van Nieukerken (ZMA). — Germany, East: 2 ♂, Bautzen, e.l. 20—22.iv.1949, J. Klimesch (ZMA). — Hungary: 1 ♂, Magyaresisatré, e.l. 12.iv.1917; 1 ♂, Nagy Nyír near Kecskemét, 4.vi.1914 (NMW). — Yugoslavia: 7 ♀, 2 km W. of Bezdan (Vojvodina), valley of Danube, e.l. 5.v.—12.vi.1984, J. J. Boomsma & E. J. van Nieukerken (ZMA).

Mines. — Austria: Klosterneuburg; Linz (leg. Klimesch); Wien, Prater. — Germany, West: München, Isarauen, 2.xi.1949, Groschke (BMNH). — Yugoslavia: Bezdan.

Additional record: Italy: Piemonte, Poggio d'Arasco, 9.vi.1977, Baldizzone (figure of ♂ genitalia by Klimesch examined).

### 13. *Ectoedemia (Ectoedemia) argyropeza* (Zeller, 1839)

(figs. 48, 165, 166, 434, 521)

*Lyonetia argyropeza* Zeller, 1839: 215. Lectotype ♀ (here designated) Poland: Silesia, Głogów (Gross Glogau), 183., Zeller, Walsingham coll. 1910—427; 101291, Genitalia slide BM 22611 (BMNH) [examined].

*Nepticula apicella* Stainton, 1854: 300. Lectotype ♀ (here designated), England: Beckenham, palings, 20.v.[18]51, Stainton, S 327/57, Genitalia slide 22610 (BMNH) [examined]. (Synonymised by Heinemann & Wocke, 1877).

[No genus] *turbidella* Herrich-Schäffer, [1853]: pl. 106 fig. 837 [nomenclatorially unavailable].

*Nepticula turbidella* Herrich-Schäffer, 1855: 357, nec Zeller. Syntypes, Austria: Wien (depository unknown) [not examined].

*Nepticula argyropezella* Doubleday, 1859: 36 (unjustified emendation).

*Nepticula turbulentella* Wocke, 1861: 129 (replacement name for *N. turbidella* Herrich-Schäffer nec Zeller).

*Nepticula simplicella* Heinemann, 1862: 319, 320. Lectotype ♀ (here designated), Germany: [Wolfenbüttel], Buchheister (specimen painted... by R. Johansson) (Niedersächsisches Landesmuseum, Hannover) [examined by R. Johansson]. *Syn. nov.*

*Nepticula argyropeza* ab. *morosella* Steudel & Hofmann, 1882: 244.

*Nepticula argyropeza* ab. *houzeaui* Dufrane, 1942: 11.

*Lyonetia argyropeza*; Tengström, 1848: 152.

*Nepticula argyropeza*; Zeller, 1848: 320, 321; Stainton, 1851: 11; 1854: 300; Frey, 1857: 398—400 [partim]; Stainton, 1859: 433 [partim, larva only]; 1862: 188—195, pl. 9 fig. 2 [partim, larva only]; Heinemann, 1871: 221; Nolcken, 1871: 795—797; Wocke, 1871: 339; 1874: 103; Heinemann & Wocke, 1877: 768; Sorhagen, 1886: 311; Tutt, 1899: 327—330; Rebel, 1901: 228; Meess, 1910: 481; Sorhagen, 1922: 57, pl. 4 fig. 66; Meyrick, 1928: 863; Hering, 1935: 7; Klimesch, 1936: 210; Szöcs, 1965: 84.

*Nepticula apicella*; Frey, 1857: 400, 401; Stainton, 1859: 433; Wocke, 1871: 339; Meyrick, 1895: 726.

[*Nepticula turbidella*; Frey, 1857: 401, 402. Misidentification].

*Nepticula simplicella*; Wocke, 1871: 340; Heinemann & Wocke, 1877: 770; Rebel, 1901: 228; Meess, 1910: 481.

*Stigmella argyropeza*; Klimesch, 1951: 64; Gerasimov, 1952: 227; Klimesch, 1961: 763; Lhomme, 1963: 1205; Borkowski, 1969: 107.

*Stigmella (Dechtrina) argyropeza*; Hering, 1957: 811 (mine).

*Dechtrina argyropeza*; Emmet, 1971: 243, 244.

*Trifurcula (Dechtrina) argyropeza*; Johansson, 1971: 245.

*Ectoedemia argyropeza*; Bradley et al., 1972: 3; Borkowski, 1975: 494; Emmet, 1976: 189, pl. 7 fig. 4, pl. 12 fig. 35.

*Ectoedemia (Ectoedemia) argyropeza*; Borkowski 1972: fig. 11 (venation).

*Trifurcula argyropeza*; Karsholt & Nielsen, 1976: 18.

Diagnosis: only females are known, which can easily be confused with *klimeschi*, see diagnosis for that species.

#### Description.

Female (fig. 48). Forewing length (2.08) 2.6—3.16 mm (3.16 ± 0.25, 39), wingspan (4.5) 5.0—

6.8 mm. Head: frontal tuft and collar yellowish orange. Antennae with 26—32 segments ( $29.0 \pm 1.7$ , 23). Thorax and forewings blackish fuscous, slightly irrorate by lighter scale basis; a medial dorsal and costal white spot, opposite, usually widely separate; dorsal spot sometimes extending along dorsal margin towards base.

Female genitalia (figs. 165, 166, 434). T7 without row of setae. T8 wide, trapezoid, with two lateral groups of scales and many setae (8—12 at least). Anal papillae with 5-9 setae. Vestibulum with vaginal sclerite, a dorsal spiculate pouch with many (about 70) single, equally spaced denticles; and a patch of densely packed pectinations near entrance of ductus spermathecae. Corpus bursae 495—660  $\mu\text{m}$ , covered with small pectinations, partly in concentric bands around signa; signa slightly dissimilar, longest 270—394  $\mu\text{m}$  ( $325.4 \pm 42.0$ , 14), shortest 240—351  $\mu\text{m}$  ( $307.3 \pm 35.4$ , 14), 3.4—4.3  $\times$  as long as wide. Ductus spermathecae with  $2\frac{1}{2}$ —3 convolutions.

Larva. Pale yellow. Prothorax and segment 10 with sternites. Ventral plates absent.

#### Biology.

Hostplant: *Populus tremula* L.

Mine. Egg on side of petiole, about 1 cm from leaf base. Mine first straight gallery in petiole, causing it to swell, later blotch in lamina between midrib and first lateral vein; frass in two lateral lines, leaving passage for larva, which often hides in petiole; mine similar to *turbidella*.

Life history. Univoltine. Larva starts feeding early, from July, mature larvae can be found from early September to November, often in green islands in fallen leaves. The larva feeds usually in dark only. Time of completing larval cycle largely depends on age of leaf: when leaf falls in September the larva will be full-grown a long time before larvae in leaves still on the tree. This probably applies as well to the related species. Adults in May and June.

#### Distribution (fig. 521).

Widely distributed in Europe, and often very abundant. Not yet recorded from Ireland, Iberian Peninsula and south of Po valley, North Yugoslavia and Rumania.

#### Remarks.

Although a distinct species, *E. argyropeza* has been the subject of much nomenclatorial confusion. I have designated as lectotype the specimen in the Zeller collection, which had

been labelled holotype by Durrant. Herrich-Schäffer (1853, 1855) was aware of the difference between *argyropeza* and *turbidella*, but interchanged these names deliberately and thus renamed *argyropeza* as *N. turbidella*. This incorrect use has, however, only been followed by Frey (1856, 1857). Stainton correctly described the biology of *argyropeza*, but mistook the adult of *albifasciella* for *argyropeza* (see under *albifasciella*). He therefore had to rename the real *argyropeza*, and gave it the name *apicella*.

R. Johansson examined the types of *N. simplicella* Heinemann and found they were just uniformly coloured examples of *argyropeza*. By courtesy of Mr. Johansson I designate here the lectotype that he selected but did not publish.

*E. argyropeza* is a parthenogenetic species, of which males are unknown. Reported males belong to either *albifasciella* or *klimeschi*. We have several times bred larvae from single females, which therefore corroborates their absolute parthenogenetic reproduction. Wilkinson & Scoble (1979) reported the species also from Canada and the USA, where it is parthenogenetic as well. Study of Canadian material showed that there is not much difference in morphology or allozyme pattern (Menken, in preparation) between them and the European populations. It is therefore likely that the North American populations are the offspring of recent introductions which may not warrant subspecific status.

Material examined: 169 ♀. — Austria: 1 ♀, Gumpoldskirchen, Glaslauerriegel, 17.v.1983, F. Kasy (NMW); 1 ♀, Linz, e.l. 17.iii.1932, J. Klimesch (MHUB); 1 ♀, Waldburg (near Freistadt), e.l. 13.ii.1921, Knitschke; 3 ♀, Wien, Haschberg, e.l. 12—18.iii.1937, Preisseecker; 1 ♀, Wien, Prater, 1867 (NMW); 2 ♀, no further data (RMNH). — France: 1 ♀, Malesherbes (Loiret), 8.v.1955, Buvat; 1 ♀, Puy Saint Vincent (Hautes Alpes), 6.vi.1965, Buvat (coll. Buvat). — Germany, West: 3 ♀, Braunschweig, Heinemann (MHUB); 1 ♀, Freiburg (MHUB); 1 ♀, Heidelberg, Ziegelhausen, 17.v.1976, W. Speidel (coll. Speidel). — Germany, East: 30 ♀, Berlin, e.l. v. Hering; 8 ♀, Nauen, e.l. 24.ii—2.iii.1924, Hering (MHUB); 9 ♀, Potsdam, e.l. 13—19.ii.1893, Hinneberg (MHUB, ZMA). — Great Britain: 6 ♀, Berley, Kent, 15.v.1947, S.N.A. Jacobs (ZMA); 3 ♀, (lecto- and paralectotypes of *apicella*), Beckenham, palings, 20—25.v.1851, Stainton (BMNH). — Italy: 2 ♀, Naturno (Bolzano), 2 km SE, N. slope, 800 m, e.l. 4.v.1984, J. J. Boomsma (ZMA). — Netherlands: 83 ♀ from following localities: Berg en Dal; Denekamp; 's-Graveland; Groote Peel; Hilversum; Overveen; Winterswijk; Zwanewater (RMNH, ZMA, coll. Koster). — Poland: 6 ♀, Wroclaw (Breslau), e.l. 15—



16.v.1858, 1863, [Wocke] (MHUB); 1 ♀ (Lectotype, see above). — No data: 1 ♀, e.l. 24.ii.1866 (MHUB).

Mines. — Austria: Peggau. — France: Barr. — Germany, West: Birresborn; Blankenheim; Wiesbaum. — Germany, East: Berlin, leg. Hering (BMNH). — Great Britain: Earls Colne (Essex). — Hungary: Budapest. — Italy: Naturno. — Netherlands: many localities. — Yugoslavia: Fužine, SW of Delnice.

### The *Ectoedemia preisseckeri* group

#### 14. *Ectoedemia (Ectoedemia) preisseckeri* (Klimesch, 1941)

(figs. 49, 102, 167, 168, 244, 293, 364, 402, 435, 479, 540)

*Nepticula preisseckeri* Klimesch, 1941: 162—168, figs. 1—10, pl. 16. Lectotype ♂ (here designated) Austria: Klosterneuburg, Kritzendf. Au, e.l. 2.v.1939, Preissecker, Ulm., Genitalia slide MV 12214 (NMW) [examined].

*Stigmella preisseckeri*; Hering, 1957: 1092, fig. 698, 705b (mine); Klimesch, 1961: 760.

*Ectoedemia (Dectirina) preisseckeri*; Klimesch, 1975c: 11, 3 figs. (♂ genitalia, mine).

*Ectoedemia preisseckeri*; Borkowski, 1975: 493.

Diagnosis: externally almost inseparable from *albifasciella*-complex, see key-characters. Male genitalia characterised by two pairs of similar, curved carinae and triangular gnathos. Female genitalia differ by combination of pectinate bursa and slightly dissimilar signa, which are much shorter than in *albifasciella*-complex.

#### Description.

Male (fig. 49). Forewing length 5.6—6.0 mm ( $2.63 \pm 0.09$ , 6), wingspan 5.6—6.0 mm. Head: frontal tuft and collar yellowish orange to ferruginous. Antennae with 36—39 segments ( $37.2 \pm 1.2$ , 6). Thorax and forewings blackish fuscous, thorax without white scales at tip of mesoscutum and tegulae; forewing with yellowish white, not shining spots: one dorsal in middle, and one costal before middle, sometimes united to form fascia. Hindwing without hair-pencil but with costal bristles.

Female. Forewing length 2.56—2.68 mm ( $2.62 \pm 0.06$ , 5), wingspan 5.7—6.0 mm. Antennae with 27—31 segments ( $29 \pm 1.6$ , 5).

Male genitalia (figs. 102, 244, 293, 364, 402). Capsule length 257—317  $\mu$ m (4). Tegumen produced into broadly triangular pseuduncus. Gnathos (fig. 293) with central element triangular, pointed. Valva (fig. 244) length 214  $\mu$ m (3), widest at base, inner margin serrate by prominent setal sockets, tip rounded; posterior mar-

gin with a notch, in ventral view suggesting a double tip. Aedeagus (fig. 364, 402) 330—334  $\mu$ m (4), with a dorsal and dorsolateral pair of strong, curved carinae of same length, dorsal pair often overlapping; aedeagus slightly constricted.

Female genitalia (figs. 167, 168, 435). Abdominal tip narrow. T7 with a row of 6—12 setae along posterior margin. T8 approximately quadrate, with two groups of 1-4 setae, without scales. Anal papillae with 12—19 setae. Vestibulum with vaginal sclerite, a dorsal spiculate pouch with many spines, both single and in rows, and a dense patch of pectinations near entrance of ductus spermathecae. Ductus bursae densely covered with pectinations. Corpus bursae 550—790  $\mu$ m, covered with small pectinations, except anterior part; signa ovoid, slightly dissimilar in length, longest 369—441  $\mu$ m (3), shortest 330—394  $\mu$ m (3), 2.4—3.0  $\times$  as long as wide. Ductus spermathecae with 2½—3½ convolutions.

Larva. Whitish, with distinct ganglia. Penultimate stages with 12 dark brown ventral plates, which are shed during final instar. See detailed description by Klimesch (1941).

#### Biology.

Hostplant: *Ulmus* spp.

Mine (fig. 479). Egg on either side of leaf, on a vein. Early mine narrow, much contorted gallery, with frass in widely separated pellets, then abruptly widening into elongate blotch, with blackish frass concentrated in basal half or at margins, often absorbing early gallery.

Life history. Univoltine. Larvae in September—October. Adults probably in May—June (reared in April—June).

#### Distribution (fig. 540).

Only known from the Danube valley, near Vienna and Budapest, although not always near the river.

Material examined: 8♂, 5♀. — Austria: 2♂, Bad Deutsch Altenburg, Pfaffenberg, 3 km SW Hainburg, e.l. 21.vi.1984, E. J. van Nieukerken (ZMA); 1♂, 1♀ (paralectotypes), Klosterneuburg, e.l. 23.iv.1939, J. Klimesch; 2♂, 1♀ (lecto- and paralectotypes), Klosterneuburg, Kritzendf. Au, e.l. 1—3.v.1939, Ulm., Preissecker; 1♀, Klosterneuburg, Kuhau, e.l. 7.v.1939, Preissecker; 1♂, Wien, L.-Enzersdorf, e.l. 19.v.1918, Ulm, Preissecker (NMW). — Hungary: 2♂, 2♀, Budapest, Kamaraerdő, e.l. 19—20.v.1975, Ulmus camp., J. Szőcs (TMAB).

Mines. — Austria: Bad Deutsch Altenburg (Hainburg); Wien, Prater.



The *Ectoedemia suberis* group

The species of this group feed on *Quercus* species, and make blotch mines. Except *aegilopidella*, they form a relatively uniform group of fasciate moths, with conspicuous hair-pencil in male, and often a hairy abdominal tip in female.

Male genitalia have large curved valvae, one pair of single carinae, and a simple gnathos.

Female genitalia are characterised by weak development of vaginal sclerite and spiculate pouch, a globular bursa, covered with pectinations and wide, similar, oval signa.

The larvae are invariably green and have no ventral plates.

The European species all occur in the southern part and the group is probably also present in the Eastern Palearctic area (*E. chasanella* Puplesis, 1984a).

### 15. *Ectoedemia (Ectoedemia) caradjai*

(Groschke, 1944)

(figs. 50, 103, 173, 245, 246, 294, 365, 407, 436, 483, 526)

*Nepticula caradjai* Hering, 1932: 16. [nomen nudum, description of mine only]; Toll, 1934b: 72 (record of mine).

*Nepticula caradjai* Groschke, 1944: 118, figs. 3, 4. ? Holotype ♀, [Italy: Sicilia, Taormina], 518 [e.l. 9.ix.1942, *Quercus pubescens*, F. Groschke] (SMNS) [examined].

*Stigmella caradjai*; Klimesch, 1951: 65, fig. 73; Gerasimov, 1952: 232; Hering, 1957: 876, figs. 530, 538, 544 (mine); Klimesch, 1961: 762.

*Nepticula caradjai*; Szöcs, 1965: 87.

*Trifurcula (Ectoedemia) caradjai*; Klimesch, 1978: 250, figs. 23, 24 (mine).

*Ectoedemia caradjai*; Szöcs, 1981: 211.

? *Trifurcula (Ectoedemia)* species; Klimesch, 1978, 250, 251, fig. 25 (mine).

Diagnosis: male recognised by combination of fascia, basal white streak on forewing and white hair-pencil, female by same wing-pattern and hairy abdominal tip. Sometimes basal streak inconspicuous, then similar to larger *suberis*, but in male of *caradjai* hair-pencil not surrounded by special scales. See also *leucothorax*. Male genitalia characterised by shape of valva. Female genitalia separated from *suberis* by shape of signa.

#### Description.

Male. Forewing length 1.88—2.4 mm (2.19 ± 0.15, 13), wingspan 4.2—5.3 mm. Head: frontal tuft yellowish to yellow mixed fuscous; collar yellowish. Antennae long, with 43—51 seg-

ments (48.3 ± 2.6, 11), scape with some brown scales. Thorax brown, with some white scales, especially at tip of mesoscutum and tegulae. Forewings fuscous, with a basal white streak along dorsum, sometimes joining fascia, sometimes inconspicuous, and a medial, almost straight fascia, sometimes broken. Hindwing with snowwhite hair-pencil of ¼ hindwing length, not surrounded by special scales.

Female (fig. 50). Forewing length 2.32—2.68 mm (4), wingspan 5.2—5.8 mm. Antennal segments 30—32 (4).

Male genitalia (figs. 103, 245, 246, 294, 365, 407). Capsule length 244—261 µm (251.1 ± 7.8, 5). Tegumen produced into small, but distinct, rounded pseuduncus (fig. 407). Gnathos (fig. 294) with narrow long central element, blunt at tip, with smooth margins. Valva (fig. 245) length 171—193 µm (187.7 ± 9.3, 5), inner margin basally almost straight, gradually becoming strongly concave towards pointed tip; outer margin uniformly convex. Aedeagus (fig. 365) 274—291 µm (282 ± 7.0, 5), carinae pointed, single, curved outwards.

Female genitalia (figs. 173, 436). T7 with a crescent-shaped patch of at least 100, very long setae, appearing pectinate at large magnifications (1000 ×). In addition T7 + 8 covered with about 50 shorter, more widely spaced setae, T8 without scales. Anal papillae wide, each with about 40 setae. Vestibulum with vaginal sclerite, and an indistinct dorsal spiculate plate, with few spines. Corpus bursae 495—570 µm, covered with pectinations, except in distal third; signa almost similar, 300—394 µm (6), 2.4—2.7 times as long as wide. Ductus spermathecae with 3½—4 inconspicuous convolutions.

Larva. Green. Ventral plates absent.

#### Biology.

Hostplants: *Quercus pubescens* Willd. s.l., from which it has been reared most often. Mines recorded from: *Q. frainetto* Ten., *Q. petraea* L. s.l. About occurrence on *Q. infectoria* Olivier and *Q. coccifera* L. see remarks.

Mine (fig. 483). Egg on either surface, usually near or at margin. Early mine narrow contorted gallery up to 1.5 cm long, filled with frass, abruptly enlarging into roundish or elongated blotch with frass heaped near entrance, or in two lateral lines.

Life history. Univoltine. Larvae from July to September, adults from late May to early July, earlier records refer to reared material. Klimesch (1978) supposed that a second generation

occurred in Anatolia, since his July larvae gave rise to adults in August.

Distribution. (fig. 526).

In central and southern Europe, south and east of the Alps. Westernmost locality is in France. Not yet recorded, but to be expected from Czechoslovakia, Rumania and Bulgaria.

Remarks.

Most authors incorrectly attribute the name *caradjai* to Hering. Although he gave this name to the species, it is not available, since he described the mine only, after 1930 (Code, art. 13a, 16). Toll was the first who reared the adult, and some of his specimens are labelled as type, but he failed to describe the species. Thus, Groschke has to be regarded as the author, since he was the first who described *caradjai*. The collection of Groschke is in SMNS, but it is almost useless, since his specimens bear only labels with a number. According to W. Speidel (pers. comm.) no diaries or notebooks belonging to Groschke could be traced to find the meaning of these numbers. However, when I borrowed all the Nepticulidae from this collection, it was apparent that all specimens numbered from 514 to 573 belong to species, which were collected in Taormina, Sicily, during the war. We know this from Groschke (1944) and from the Hering Herbarium (BMNH), where many nepticulid mines collected by Groschke are to be found. It is furthermore notable, that the first (514) and last (573) number are represented by species, which are typically mediterranean, i.e. *Nepticula euphorbiella* Stainton and *N. groschkei* Skala, therefore probably none of this series was collected elsewhere. There is one ♀ specimen in this collection, labelled 518, which corresponds completely with Groschke's description, and undoubtedly belongs to *caradjai*, but unfortunately lacks the abdomen. Groschke only mentioned one specimen in his description, so with some reluctance, it is accepted as the holotype of *caradjai*.

It is not yet clear if *caradjai* is one variable species, or forms a complex comparable with *subbimaculella*. Klimesch reared some very similar specimens from the semi-evergreen *Quercus infectoria* and the evergreen *Q. coccifera* (Klimesch, 1978). These specimens differ slightly since they are smaller, but do not show diagnostic differences. Their measurements are therefore excluded from the above mentioned data, but follow here:

1. from *Q. infectoria*. ♂: forewing length 1.84—2.04 mm (2), antennal segments 47—48. Capsule 206 µm, valva 171 µm (fig. 246), aedeagus 244 µm. ♀: forewing length 1.88—2.04 mm, antennal segments 31—32. Bursa 440 µm, signa 227—270 µm, 2.3—2.5 × as wide as long, less setae on T8 and anal papillae (about 20) (see fig. 174).
2. from *Q. coccifera*. ♀: forewing length 2.2 mm, antennal segments 33. Bursa 570 µm, signa 334—343 µm, 2.8 × as long as wide, 30 setae on anal papillae; ductus spermathecae with 3 convolutions (fig. 175).

More material is needed to check the constancy of these observations, and also especially to compare specimens reared from *Q. pubescens* on Rhodos.

Material examined: 17 ♂, 7 ♀. — Austria: 1 ♂, Gumpoldskirchen, Glaslauerriegel, 4.vii.1976, Kasy; 2 ♂, Hackelsberg, N. of Neusiedlersee, 23.vi.1975, 29.vi.1977, Kasy; 1 ♂, Wien, Leopoldsb., e.l. 26.v.1943, *Q. pubescens*, Preissecker (NMW). — Hungary: 1 ♂, Csopak, e.l. 24.v.1971, J. Szócs; 1 ♀, Nagykovaci, Remetehegy, e.l. 19.vi.1963, J. Szócs (TMAB). — Italy: 6 ♂, Monti Aurunci (Latina), 4 km NW Castelforte, 400 m, 22—23.vi + 1.vii.1969, R. Johansson (coll. Johansson); 1 ♂, Sitizano (Calabria), 450 m, 28.viii.1977, S. E. Whitebread (coll. Whitebread); 1 ♀, ? Holotype (see above). — Turkey: 1 ♂, Anatolia, Kizilcahamam, 700 m, 31.vii—1.viii.1963, Arenberger (LNK); USSR: 2 ♂, 4 ♀, Babince, k. Krzywca (Podolia), e.l. 5.iii.1938 + 21.iii—1.iv.1939, *Q. pubescens*, S. Toll (IPAK, MHUB); 2 ♂, Scianka Hlody, p. Borszczów (Podolia), e.l. 25—26.ii.1939, S. Toll (IPAK, MHUB). — Yugoslavia: 1 ♀, Treschkaschlucht, near Skopje, 21—30.vi.1959, F. Kasy (NMW).

Identity uncertain: 2 ♂, 4 ♀. — Greece: 2 ♂, 3 ♀, Rhodos, Treas, e.l. 20—30.iv.1978, *Quercus infectoria*, J. Klimesch; 1 ♀, Rhodos, Trianta, e.l. 4.v.1974, *Quercus coccifera*, J. Klimesch (ZSMK).

Mines. — On *Quercus frainetto*. — Greece: Oiti Oros (Fthiotis). On *Quercus petraea* s.l. — Greece: W. Palaiokastron (Evrítania). On *Quercus pubescens*. — Austria: Gumpoldskirchen; Hainburg; Hundshheimer Berg. — France: Aix-en-Provence, leg. J. W. Schoorl; Viens (Vaucluse) (near Apt), leg. R. Buvat. — Greece: Evvoia, Dhirfis Oros; Oiti Oros (Fthiotis); Voutonási (Ioannina). — Italy: Abruzzi: Goia dei Marsi; Picinisco; Lazio: Veio; Sicilia, Taormina, leg. Groschke (BMNH); USSR: Bendery (Tighina), leg. Hering (BMNH).

Identity uncertain: on *Quercus infectoria*. — Greece: Rhodos, leg. Klimesch.

16. *Ectoedemia* (*Ectoedemia*) species  
(specimen 1843)  
(figs. 104, 247, 295, 366)



Material: 1 ♂: Spain: Aragon, Rubielos de Mora, 4.vii.1967, Arenberger, Genitalia slide VU 1843 (LNK).

This specimen clearly belongs in the group near *caradjai* and *suberis*, but is almost certainly specifically different. Due to the bad condition of the specimen, however, I refrain from naming it. It is most easily separated from the other species in the group by the ochreous brown hair-pencil, surrounded by brown lamellar scales. The genitalia are most similar to *caradjai*.

#### Description.

Male. Forewing length 2.44 mm, wingspan 5.4 mm. Antennal segments not countable. Worn specimen, wing pattern similar to *suberis*. Hindwing with ochreous brown hair-pencil, surrounded by brown lamellar special scales.

Male genitalia (figs. 104, 247, 295, 366). Capsule length 257  $\mu\text{m}$ . Tegumen very broad, truncate. Gnathos with triangular central element (fig. 295). Valva (fig. 247) length 206  $\mu\text{m}$ , inner margin concave, outer margin strongly convex, tip pointed. Aedeagus (fig. 366) 304  $\mu\text{m}$ , carinae pointed, single.

#### 17. *Ectoedemia (Ectoedemia) suberis*

(Stainton, 1869) comb.n.

(figs. 51, 105, 169, 170, 248, 296, 367, 408, 437, 480, 542)

*Nepticula suberis* Stainton, 1869: 229. Lectotype ♂ (here designated), France: Cannes, e.l., found dead, iii.[18]68, *Q. suber*, green larva, Stainton, Genitalia slide BM 22577 (BMNH) [examined].

*Nepticula viridella* Mendes, 1910: 165, pl. 7, figs. 6, 9. Syntypes, Portugal, prov. Beira Baixa, San Fiel, Mendes (depository unknown) [not examined] **Syn. nov.**

*Nepticula suberis*; Wocke, 1871: 338; Rebel, 1901: 227; Meess, 1910: 479; Petersen, 1930: 71, fig. 101 (♂ genitalia).

*Stigmella suberis*; Gerasimov, 1952: 262; Hering, 1957: 868, fig. 539 (mine); Lhomme, 1963: 1196.

*Stigmella (Stigmella) suberis*; Leraut, 1980: 48.

*Nepticula viridella*; Hering, 1935: 373.

*Stigmella viridella*; Gerasimov, 1952: 260; Hering, 1957: 867 (mine).

Diagnosis: separated from *caradjai* by absence of white basal streak on forewing, and presence in male of white lamellar scales, surrounding hair-pencil. The hair-pencil in male, and the dense group of long setae on the female postabdomen also separate *suberis* from *haraldi* and other similar oak-mining species. In male genitalia the shape of the valva is very characteristic. See also diagnosis for *andalusiae*.

#### Description.

Male. Forewing length 2.72—3.08 mm ( $2.95 \pm 0.09$ , 22), wingspan 6.5—6.8 mm. Head: frontal tuft yellowish orange to ferruginous; collar lighter. Antennae long with 49—60 short segments ( $54.9 \pm 3.3$ , 17). Thorax and forewing brown, irrorate with white; a medial almost straight dull white fascia. Hindwing with white hair-pencil surrounded by white special lamellar scales.

Female (fig. 51). Forewing length 2.8—3.24 mm ( $3.05 \pm 0.10$ , 23), wingspan 6.4—7.2 mm. Antennal segments 37—43 ( $39.1 \pm 1.5$ , 18).

Male genitalia (figs. 105, 248, 296, 367, 408). Capsule length 261—296  $\mu\text{m}$  ( $279.5 \pm 11.5$ , 9). Tegumen produced into broadly triangular, rounded pseuduncus (fig. 408). Gnathos (fig. 296) with long triangular central element. Valva (fig. 248) length 201—227  $\mu\text{m}$  ( $212.7 \pm 9.1$ , 8), basally broad with inner margin convex, below middle suddenly narrowed and inner margin becoming concave towards tip. Aedeagus (fig. 367) 343—394  $\mu\text{m}$  ( $375 \pm 18.0$ , 8), much longer than capsule, carinae single, pointed, slightly curved outwards.

Female genitalia (figs. 169, 170, 437). T7 with a semicircular patch of 120—200 very long, smooth setae. T7 and 8 in addition with about 80—100 shorter setae, without scales. Anal papillae with 29—37 setae. Vestibulum with vaginal sclerite and a spiculate pouch with hardly visible spines, without pectinations. Corpus bursae almost globular, 550—660  $\mu\text{m}$ ; covered with minute pectinations; signa similar, 364—437  $\mu\text{m}$  ( $417.4 \pm 40.0$ , 10), 2.3—2.4  $\times$  as long as wide. Ductus spermathecae with 4—4½ distinct convolutions.

Larva. Dirty green, with conspicuous brown ganglia. Ventral plates absent.

#### Biology.

Hostplants: *Quercus suber* L., *Q. ilex* L., *Q. rotundifolia* Lam, *Q. coccifera* L. and possibly *Q. faginea* Lam.

Mine (fig. 480). Egg on leaf-upperside. Mine starts as contorted gallery filled with frass, later widening into large irregular blotch with the frass in basal half or in two lateral lines. Larva feeds only in upper parenchym layers.

Life history. Univoltine. Larva feeds in winter, mainly from January to March, occasionally early April. Larva or pupa aestivates in cocoon, adult flies from July to early October, but some specimens from Marbella were taken in June.



## Distribution (fig. 542).

Western mediterranean species, known from Iberian peninsula, France, Corsica, Sardinia and North Africa. Not recorded from mainland Italy.

## Remarks.

In contrast with *ilicis*, no types of *viridella* Mendes could be found in the De Joannis collection in Paris, but it does contain two specimens, labelled *viridella*, collected in Salamanca (Spain), probably by Mendes, who lived there after 1910 (Zerkowitz, 1946). These specimens are identical with *suberis*. Also Mendes' description does not give reason to believe that *viridella* should be regarded as a distinct species, it is therefore synonymised here.

Material examined: 33 ♂, 33 ♀. — France: 1 ♂, Lectotype (see above); 2 ♂, Cannes, Ragonot (RMNH); 2 ♂, 4 ♀, Alp. Mar., Cannes, Constant (IRSN, MNHN, RMNH); 1 ♀, Collobrières (Var), e.l. 3.ix.1981, *Quercus suber*, S. E. Whitebread (coll. Whitebread); 3 ♂, Corse, e.l. 29.viii + 6.ix.1906, *Q. ilex*, Chrétien (MNHN); 1 ♀, Golfe Juan, Alp. marit., Constant (IRSN); 1 ♂, 3 ♀, « Nesp. » (? near St. Pons, dep. Hérault), 2.viii.1904, Chrétien; 3 ♂, St. Pons, 4.viii.1904, Chrétien (MNHN). — Italy: 3 ♂, Sardegna, Mt. Istiddi, 1.ix.1978, G. Derra; 1 ♂, Sardegna, Bacu Trotu, Ortuabis, 800 m, 28.viii.1978, G. Derra (coll. Derra); 1 ♂, Sardegna, prov. Nuoro, Villanova-Srisaili 885 m, 7.vii.1983, J. Kuchlein (coll. Kuchlein). — Morocco: 1 ♂, Tanger, 2.v.1902, Walsingham (BMNH). — Spain: 1 ♂, Albarracín (Aragonia), e.l. ix.1933, *Quercus ilex*, Hering (MHUB); 1 ♂, 1 ♀, Alcuéscar, Cáceres, 1.x.1983, C. Gielis (Coll. Gielis; EvN); 3 ♂, Andalucía, prov. Málaga, road to Ojen, 150 m, 12.vi.1981, E. Traugott-Olsen (ETO); 1 ♂, 7 km N. Benahavis (Málaga), road to Ronda, 800 m, e.l. 21—22.viii.1984, *Quercus coccifera*, E. J. van Nieukerken (ZMA); 1 ♂, 1 ♀, La Vid (Burgos), 800 m, 23—28.ix.1965, H. G. Amsel; 1 ♂, Cataluna, Port Bou, 18—28.ix.1966, Arenberger (LNK); 1 ♀, 4 km NE Igualeja, Serrania de Ronda (Málaga), 1100 m, e.l. 21—22.viii.1984, *Quercus rotundifolia*, E. J. van Nieukerken; 1 ♂, 7 ♀, Marbella (Málaga), Casa y Campo, 100 m, e.l. 29.viii—29.x.1984, *Quercus coccifera*, E. J. van Nieukerken (ZMA); 1 ♂ 2 ♀, Las Mur-tas (near Elche), Murcia, 23.ix.1983, C. Gielis (coll. Gielis; EvN); 1 ♂, 1 ♀, Salamanca, e.l. 25.viii., *Q. ilex* [Mendes], coll. de Joannis (as *viridella*) (MNHN); 1 ♀, San Roque, Cadiz, 29.ix.1983, C. Gielis; 4 ♂, 10 ♀, Sierra Blanca, 6 km N. Marbella (Málaga), El Mirador, 800 m, e.l. 13—28.viii.1984, *Quercus suber* + *rotundifolia*, E. J. van Nieukerken (ZMA).

Mines. — On *Quercus suber*. — France: Collobrières, Var., leg. Whitebread; Plan d'Aups, Var., leg. Whitebread (coll. Whitebread). — Spain: prov. Málaga: Casares; Istan; Marbella; Serrania de Ronda; Sierr-

ra Blanca, N. Marbella. — Tunisia: Jebel Abiod; Ain Draham. On *Quercus ilex*. — France: Corsica, Barbi-caja, leg. Buhr (BMNH). On *Quercus rotundifolia*. — Algeria: Aurès Mts, near Arris; Aurès Mts, Dj. Chéla. — Spain: Sierra Almirara, N. Otivar; Sierra Blanca, N. Marbella; Serrania de Ronda. Identity uncertain: on *Quercus faginea*. — Spain: Istan.

18. *Ectoedemia* (*Ectoedemia*) *andalusiae*

sp. n.

(figs. 52, 106, 171, 172, 249, 297, 368, 409, 438, 481, 526)

Type material: Holotype ♀: Spain (Málaga): Marbella, Casa y Campo, 100 m, 8.ii.1984, e.l. 17—18.v.1984, *Quercus coccifera*, VU no. 84043 KE, E. J. van Nieukerken, Genitalia Slide 1899 (ZMA). Paratypes, 4 ♂, 3 ♀. — Spain: 2 ♂, 1 ♀, Andalucía, prov. Málaga, Camino de (road to) Ojen, 150 m, 12.vi.1981, E. Traugott-Olsen (ZMA, ETO); 1 ♂, idem, 21.vi.1980; 1 ♀, Andalucía, prov. Málaga, Camino de (road to) Istan, 400 m, 4.vii.1973, E. Traugott-Olsen (ETO); 1 ♂, Marbella, Casa y Campo, ca 100 m, 18.ix.1982, E. Traugott-Olsen (ETO); 1 ♀, Pyr. Orient., Tolorin b. Martinet, 6.vii.1967, Arenberger (LNK). Mines examined: on *Q. coccifera* from type locality, mixed with *E. suberis* mines.

Diagnosis: ♀ separated from *suberis* by absence of long setae on abdominal tip; from *baraldi* by straighter fascia and genitalia. ♂ very similar to *suberis*, separated by ochreous-brown hair-pencil instead of white, and markedly shorter capsule with blunt and wide tegumen.

## Description.

Male. Forewing length 2.44—2.72 mm (4): wingspan 5.4—6.2 mm. Head: frontal tuft and collar yellowish-orange. Antennae with 49-57 segments. Thorax and forewings brown, with medial, almost straight, constricted, dull-white fascia. Hindwing with ochreous-brown hair-pencil, surrounded by white lamellar scales as in *suberis*.

Female (fig. 52). Forewing length 2.4—3.04 mm (4), wingspan 5.5—6.9 mm. Antennae with 35—38 segments.

Male genitalia (figs. 106, 249, 297, 368, 409). Capsule length 223—261 μm (4). Vinculum anteriorly narrower than in *suberis*. Tegumen truncate, very broad, hardly produced into pseuduncus (fig. 409). Gnathos (fig. 297) with triangular central element. Valva (fig. 249) length 193—210 μm (4), basally broad with inner margin convex, below middle suddenly narrowed

and inner margin becoming concave towards tip. Aedeagus (fig. 368) 309—351  $\mu\text{m}$  (4), much longer than capsule, carinae single, pointed, slightly curved outwards.

Female genitalia (figs. 171, 172, 438). T7 without long setae. T8 with two lateral patches of scales and 4—7 setae. Anal papillae wide, with 18—24 setae. Vestibulum with vaginal sclerite and a spiculate pouch with very few, small spines, without pectinations. Corpus bursae almost globular, 495—640  $\mu\text{m}$ ; covered with minute pectinations; signa similar, 330—377  $\mu\text{m}$  ( $348.2 \pm 1.41$ , 8),  $1.9$ — $2.5 \times$  as long as wide. Ductus spermathecae with  $5\frac{1}{2}$  convolutions.

Larva. As *suberis*.

#### Biology.

Hostplant: *Quercus coccifera* L., from which hostplant is bred.

Mine (fig. 481). Not differentiated from the mine of *suberis*.

Life history. Adults taken in June, July and one male in September, larvae found in January.

Distribution (fig. 526).

Only known from Spain.

#### Remarks.

This species is closely related to *E. suberis*, but the female shows several diagnostic features, especially in the abdominal tip. The holotype was reared from a mixed sample of mines collected on *Quercus coccifera*, from which also *suberis* has been reared. The mines do not give any evidence of the presence of two species.

### 19. *Ectoedemia (Ectoedemia) aegilopidella*

(Klimesch, 1978) comb. n.

(figs. 53, 54, 107, 176, 250, 298, 369, 410, 439, 482, 546)

*Trifurcula (Ectoedemia) aegilopidella* Klimesch, 1978: 269—271, figs. 65—69. Holotype  $\delta$ , Greece: Rhodos: Rodini, e.l. 17—30.iv.1973, Zucht nr. 1054, *Quercus macrolepis*, 22.ix.1972, J. Klimesch, Genitalia slide Kl. 4107 (ZSMK) [genitalia slide examined].

Diagnosis: very small species with a wingspan of less than 4.2 mm. Males with basal  $\frac{2}{3}$  of hindwing covered with brown special scales, as in *heringella* and *terebinthivora*, but separated from these two by presence of a hair-pencil in *aegilopidella*. Females very similar to *terebinthivora*, but *terebinthivora* has a more yellow fascia. Male genitalia very characteristic and di-

agnosed by small size, wide capsule, gnathos and tegumen. Female genitalia characterised by absence of group of many long setae and small and short signa.

#### Description.

Male (fig. 53). Forewing length 1.80—1.92 mm (2), wingspan 4.0—4.2 mm. Head: frontal tuft and collar yellowish white. Antennae with 35—37 segments (2). Thorax and forewings ochreous-brown, with a medial, often ill-defined, straight fascia, colour yellowish white. Underside of forewing with a group of brown androconial scales in distal half, and a group of short, yellowish-white lamellar scales near costal retinaculum. Hindwing with a yellowish-white hair-pencil of  $\frac{1}{4}$  hindwing length; basal  $\frac{2}{3}$  covered with brown lamellar, special scales.

Female (fig. 54). Forewing length 1.58—1.80 mm (3), wingspan 3.8—4.1 mm. Antennae with 23—25 segments (3). Underside forewing and hindwing without special scales.

Male genitalia (figs. 107, 250, 298, 369, 410). Capsule very short, length 150—167  $\mu\text{m}$  (3). Tegumen produced into ventral globular pseuduncus (fig. 410). Gnathos (fig. 298) with central element broad and truncate, in form of a transverse bar. Valva (fig. 250) length 133—150  $\mu\text{m}$ , basally broad, below middle suddenly narrowed and inner margin becoming concave towards tip; outer margin uniformly convex. Aedeagus (fig. 369) 244—279  $\mu\text{m}$  (3), more than  $1.5 \times$  as long as capsule, carinae single, pointed.

Female genitalia (figs. 176, 439). T7 without long setae. T8 small, with few scales laterally and with 8—14 setae. Anal papillae with 6—8 setae. Vestibulum with vaginal sclerite, slightly different from that in other species and a spiculate pouch with very few small spines, without pectinations. Corpus bursae small, 310—350  $\mu\text{m}$ , covered with many pectinations, except distal part; signa similar, oval, 189—223  $\mu\text{m}$  ( $209.3 \pm 14.9$ , 6),  $2.0$ — $2.3 \times$  as long as wide. Ductus spermathecae with 3— $3\frac{1}{2}$  convolutions.

Larva emerald green, head-capsule brown. No ventral plates (Klimesch, 1978).

#### Biology.

Hostplant: *Quercus macrolepis* Kotschy.

Mine (fig. 482). Egg on leaf upperside. Early mine contorted gallery, widening into irregular blotch or wide gallery, with dispersed central frass.

Life history. Probably univoltine. Larvae collected in September, adults emerged in April.



Distribution (fig. 546).  
Only known from Rhodos.

Material examined: 3 ♂, 3 ♀ (holo- and paratypes), Greece, Rhodos, Rodini, c.l. 17—30.iv.1973, *Quercus macrolepis*, 22.ix.1972, J. Klimesch (ZSMK). Mines: 2 mines, same data (ZMA).

#### The *Ectoedemia subbimaculella* group

This is a uniform group of *Quercus* mining species, making gallery mines or gallery-blotch mines.

Adults of this group have various colour patterns, but never with metallic shining spots or fasciae. Males of most species possess costal bristles instead of a hair-pencil, except *quinquella*, cf. *algeriensis* and *gilvipennella*.

The group is best characterised by the female genitalia: vestibulum with a ring-shaped vaginal sclerite, a spiculate pouch with the spicules partly separate, partly in small rows of 2—3 in contrast to *populella*-group, and a patch of dense pectinations near entrance of ductus spermathecae. In contrast with all other *Ectoedemia* species except *intimella*, the corpus bursae is devoid of pectinations. The signa are long and elongate, dissimilar, the shortest being 3.5—7.5 times as long as wide, except in *leucothorax*.

Larvae are yellow, whitish or green, and many species possess black ventral plates during the penultimate instars.

The group is best developed in the mediterranean area, and also occurs in Japan.

#### 20. *Ectoedemia (Ectoedemia) quinquella*

(Bedell, 1848)

(figs. 55, 108, 177, 251, 299, 370, 411, 440, 485, 527)

*Microsetia quinquella* Bedell, 1848: 1986. Syntypes, England, West Wickham, 30.vi.1847, G. Bedell, (depository unknown), [not examined]

[no genus] *quinquella*; Herrich-Schäffer [1854]: pl. 114 fig. 928.

*Nepticula quinquella*; Stainton, 1849: 29; 1854: 301; Herrich-Schäffer, 1855: 355; Frey, 1857: 407, 408; Stainton, 1859: 433; Wocke, 1871: 339; Meyrick, 1877: 111, 112; 1895: 725; Tutt, 1899: 342, 343; Rebel, 1901: 227; Meess, 1910: 480; Meyrick, 1928: 862; Petersen, 1930: 76, fig. 114 (♂ genitalia).

*Dechtira quinquella*; Beirne, 1945: 206, fig. 71 (♂ genitalia); Emmet, 1971: 248.

*Stigmella quinquella*; Gerasimov, 1952: 255; Lhomme, 1963: 1201.

*Stigmella (Dechtira) quinquella*; Hering, 1957: 870, fig. 534 (mine).

*Trifurcula (Ectoedemia) quinquella*; Johansson, 1971: 245.

*Ectoedemia quinquella*; Bradley et al., 1972: 2; Emmet, 1976: 189, pl. 6, fig. 16, pl. 12, fig. 33.

Diagnosis: easily separated from all other *Ectoedemia* species, described here, except *algeriensis*, by characteristic pattern of three white spots on forewing: a costal, a dorsal and a discal spot. It can be separated from *algeriensis* by its dark thorax, and males from cf. *algeriensis* by the darker hair-pencil and different form of valva and gnathos.

#### Description.

Male. Forewing length 1.84—2.28 mm (2.10 ± 0.17, 6), wingspan 4.2—5.0 mm. Head: frontal tuft almost completely black, with a few fuscous scales on frons; collar black. Antennae with 36—42 segments (39.8 ± 2.6, 4). Thorax black, posterior tips of mesoscutum and tegulae white. Forewings black with three white spots: a costal on 1/3 from wingbase, a dorsal, approximately in middle, and a discal on 2/3 from base, sometimes a few white scales near wingbase. Hindwing with yellowish hair-pencil of approximately 1/4 hindwing length, surrounded by yellow lamellar scales.

Female (fig. 55). Forewing length 2.04—2.68 mm (2.37 ± 0.19, 8), wingspan 4.6—5.6 mm. Antennal segments 26—29 (28.1 ± 1.1, 7).

Male genitalia (figs. 108, 251, 299, 370, 411). Capsule length 227—266 μm (2). Tegumen (fig. 411) rounded, slightly indented at tip. Gnathos (fig. 299) with central element divided, distal part spatulate, basal part with serrate margin. Valva (fig. 251) length 171—257 μm (2), inner margin concave, except basally, tip narrow, dorsal surface with comparatively few setae. Aedeagus (fig. 370) length 171—257 μm (3), carinae pointed, single or bifurcate, sometimes with additional spines at base.

Female genitalia (figs. 177, 440). T8 with two lateral groups of scales and few setae, on T7 along anterior margin of T8 a few small setae, not arranged in distinct row. Anal papillae with 12—18 setae. Vestibulum with vaginal sclerite, a dorsal spiculate pouch, and a group of densely packed pectinations near entrance of ductus spermathecae. Corpus bursae 550—670 μm, without pectinations; signa dissimilar, longest 411—514 μm (4), shortest 356—454 μm, 4.0—4.7 × as long as wide (4). Ductus spermathecae with 2 indistinct convolutions.

Larva. Yellow, with dark brown head-capsule and conspicuous black ventral plates, which are shed during final instar. Thereafter ganglia visible.



## Biology.

Hostplants: *Quercus robur* L. and *Q. petraea* L. s.l.

Mine (fig. 485). Egg on leaf underside, often against vein. Mine highly contorted gallery; early mine filled with narrow linear frass, later with irregular dispersed black frass, leaving wide clear margins. Often many mines occur in the same leaf.

-Life history. Univoltine. Larvae occur late in the season, in England in late October and November, in Greece very young larvae have been found in mid September. The adults fly in the second half of June and early July.

## Distribution (fig. 527).

Atlantic-mediterranean species, locally abundant in southern England, known from a small number of localities in Belgium, France, Italy and Greece. Record from Norway (Grönlien, 1937) probably incorrect.

## Remarks.

Types of this species are unknown, and Bedell's collection does not seem to exist any more (see *atrifrontella*). From Bedell's description and figure the identity of this species is not in doubt.

Material examined: 6 ♂, 11 ♀. — Belgium: 1 ♀, Tervuren, 20.vi.1888, Crombrugghe; 1 ♀, Zolder, 27.vi.1938, E. Janmoulle (IRSN). — France: 1 ♀, Achères (Yvelines), 22.vi.1947, Le Marchand; 1 ♂, l'Étang la Ville (Yvelines), 21.vi.1942, Le Marchand (MNHN); 1 ♂, Vannes, e.l. 27.vi.1913, Joannis (IRSN). — Great Britain: 2 ♂, 1 ♀, 10 km NE Newmarket, Herringswell, 11.xi.1981, e.l. 8—10.vi.1982, A. M. Emmet, J. W. Schoorl; 1 ♀, Pods Wood, 2 km N. of Tiptree (Essex), 23.x.1979, e.l. 17.vi.1980, A. M. Emmet, G. Bryan & E. J. van Nieukerken; 2 ♂, 4 ♀, 3 km E. Rainham, Belhus Wood, 24.x.1979, e.l. vi.1980, G. Bryan, E. J. van Nieukerken (ZMA, partly on alcohol). — Greece: 1 ♀, Litochorion, 3—400 m, 14—22.vi.1957, J. Klimesch (ZSMK). — Country unknown: 1 ♀, Macedonia, Kr., coll. Staudinger (MHUB).

Mines. — On *Quercus robur*. — Great Britain: Herringswell; Tiptree; Rainham; Weeley. On *Quercus petraea* s.l.. — Greece: 4 km W. Palaioastron, Evritania.

Additional records (figs. of externals and ♂ genitalia by Klimesch, examined). — Italy: Liguria, Testico (near Alassio), 470 m, 5.vii.1969, Jäckh; Liguria, Conna, S. Sebastiano (near Pigna), 4.vii.1969, Jäckh.

Type material: Holotype ♀: Algeria: Aurès, near Arris, 32 km SSE of Batna, 1700 m, 28.iv.1980, open *Q. ilex* veg., stat. 25, e.l. 13.vi.1980, *Quercus ilex*, VU no 80064 KE, Bryan, van Nieukerken & Oosterbroek, Genitalia slide 1125 (ZMA). Paratypes, 2 ♀, same data as holotype, e.l. 13—16.vi.1980 (BMNH, ZMA); Mines examined from type locality and from Algeria: Aurès, Dj. Chélia, 1600—1900 m.

Diagnosis: externally very similar to *quinquella*, but thorax entirely white and basal white spot present. Genitalia (♀) very characteristic by dense hairy abdominal tip.

## Description.

Male. Unknown, but see below.

Female (fig. 56). Forewing length 2.28—2.56 mm (3), wingspan 5.0—5.6 mm. Head: frontal tuft and collar fuscous to black. Antennae with 27—33 segments (3). Thorax completely white. Forewings black, with four white spots: a small basal, a large costal before middle, a dorsal, approximately in middle and a discal at  $\frac{2}{3}$  from wingbase.

Female genitalia (figs. 178, 441). T8 (and T7?) with more than 70 long setae, partly in row along anterior margin, no scales. Anal papillae with 24—28 setae. Vestibulum with vaginal sclerite, a prominent dorsal spiculate pouch, and a group of densely packed pectinations near entrance of ductus spermathecae. Corpus bursae 605—660 µm without pectinations; signa dissimilar, longest 386—450 µm (2), shortest 355—420 µm, 3.5—3.9 × as long as wide (2). Ductus spermathecae with 2 indistinct convolutions.

Larva. Green, without ventral plates. Not examined in detail.

## Biology.

Hostplant: *Quercus rotundifolia* Lam. (often regarded as form of *ilex*).

Mine (fig. 484). Egg on upper surface, often on or near vein. Gallery, much contorted with black frass leaving narrow clear margins. Mine similar to that of *ilicis*, *heringella* and *haraldi*, only separable by colour of larva.

Life history. Larvae taken in late April, adults emerged in June. Males of cf. *algeriensis* found in July.

## Distribution (fig. 527).

Algeria: Aurès mountains, and probably Morocco (see remarks).

21. *Ectoedemia (Ectoedemia) algeriensis* sp.n.

(figs. 56, 178, 441, 484, 527)

## Remarks.

This species is described from three females reared from a small sample, from which unfortunately no males emerged. Although clearly related to *quinquella*, it is a distinct species, differing in genitalia and biology. The males described below probably belong to *algeriensis* because, although they resemble *quinquella*, they also differ in some ways. It is however not wise to include them in the type-series of *algeriensis*, since they are too worn. Also they have not been reared.

I have reared 1 ♀, (slide 1897) from *Quercus coccifera* from Spain (Málaga): 7 km N. Benahavis, road to Ronda, 800 m, 7.ii.1984, e.l. 17—18.iv.1984, which externally corresponds with *algeriensis*, and also in the internal genitalia. However, the terminal segments differ (fig. 442) from those of the type series, and I therefore can not identify this specimen with certainty until further material is available.

21A. *Ectoedemia* (*Ectoedemia*) cf. *algeriensis* sp.n. (male)  
(figs. 109, 252, 300, 371)

Material: 2 ♂, Morocco: Moyenne Atlas, Azrou, 16.vii.1975, F. Kasy (NMW). Two worn males, which probably belong to *algeriensis*, see remarks on that species.

Diagnosis: wing pattern unknown, differs from *ilicis* and *heringella* by presence of hair-pencil, from *quinquella* by white hair-pencil, and from all by large number of antennal segments. Genitalia similar to *ilicis* and *heringella*, but central element of gnathos remarkably large.

## Description.

Male. Forewing length 2.4 mm, wingspan  $\pm$  5.4 mm. Head: colour of frontal tuft unknown, all scales lost in the two specimens. Antennae long, with 53—54 segments. Thorax probably white. Colour-pattern of forewing not recognisable, but presence of discal spot likely, the distribution of the few scales left on the wings, suggest the likelihood of a similar pattern as *algeriensis*. Hindwing with a white hair-pencil, surrounded by a patch of yellow scales.

Male genitalia (figs. 109, 252, 300, 371). Capsule 257  $\mu$ m long. Tegumen rounded. Gnathos (fig. 300) with central element divided, distal part prominent, spatulate, basal part with serrate margin. Valva (fig. 252) length 206  $\mu$ m, inner margin concave, tip wide and truncate, dor-

sal surface with few setae. Aedeagus (fig. 371) 274  $\mu$ m, carinae pointed, bi- or trifurcate.

22. *Ectoedemia* (*Ectoedemia*) *gilvipennella* (Klimesch, 1946) comb. n.

(figs. 57, 58, 110, 179, 253, 301, 372, 443, 486, 543)

*Stigmella gilvipennella* Klimesch, 1946: 168, fig. 8. Lectotype ♂ (here designated), Italy: Liguria, Ferrania near Altare, e.l. 26.iv.—7.v.1945, *Quercus cerris*, ix.1944, Zucht No. 509, J. Klimesch, Genitalia slide Kl. 272 (ZSMK) [examined].

*Stigmella* (*Stigmella*) *gilvipennella*; Hering, 1957: 870. *Nepticula* (*Stigmella*) *gilvipennella*; Szöcs, 1968: 228.

Diagnosis: the only predominantly white *Ectoedemia*, further characterised in the male by the prominent fuscous or black hair-pencil. The other uniformly coloured *Ectoedemia* species are darker and often larger. Without examining genitalia or venation, females could be mistaken for *Trifurcula* or *Acalyptis* species. Male genitalia very similar to those of *quinquella*, but separated by dorsal lobe of valva.

## Description.

Male (figs. 57, 58). Forewing length 2.08—2.48 mm ( $2.32 \pm 0.13$ , 12), wingspan 4.9—5.4 mm. Head: frontal tuft yellowish, mixed with fuscous, especially on vertex; collar yellowish white. Antennae with 28—34 segments ( $30.8 \pm 1.5$ , 11). Thorax and forewings predominantly white, irrorate with dark brown tipped scales, no distinct colour-pattern. Hindwing with fuscous to black hair-pencil of  $\frac{1}{5}$  hindwing length, not surrounded by special scales.

Female. Forewing length 1.96—2.36 mm ( $2.21 \pm 0.13$ , 13), wingspan 4.4—5.2 mm. Antennal segments (17)23—24 ( $23.4 \pm 0.5$ , 10).

Male genitalia (figs. 110, 253, 301, 372). Capsule length 210—240  $\mu$ m ( $219.4 \pm 11.9$ , 5). Tegumen rounded. Gnathos (fig. 301) with central element divided, distal part spatulate, basal part with serrate margin. Valva (fig. 253) length 171—193  $\mu$ m ( $177 \pm 8.9$ , 5), inner margin concave, outer margin dorsally folded back, forming an inwardly projecting lobe, covering several setae, tip pointed. Aedeagus (fig. 372) 244—257  $\mu$ m ( $248.6 \pm 6.1$ , 4), carinae pointed, single.

Female genitalia (figs. 179, 443). T7 with a row of 8 long setae along anterior margin of T8; T8 with 8 setae, no scales. Anal papillae with 11—13 setae. Vestibulum with vaginal sclerite, a dorsal spiculate pouch, and a group of densely packed pectinations near entrance of ductus spermathecae. Corpus bursae 500  $\mu$ m, without

pectinations; signa dissimilar, longest 347  $\mu\text{m}$  (1), shortest 330  $\mu\text{m}$  (1),  $3.9 \times$  as long as wide. Ductus spermathecae with 3 convolutions.

Larva. Bright emerald green, with light yellow head-capsule. Ganglia invisible, ventral plates absent.

#### Biology.

Hostplant: *Quercus cerris* L.

Mine (fig. 486). Egg on leaf upperside, often on or near vein. Early mine: narrow contorted gallery with broken brown frass, later becoming wide and more contorted gallery filled with brown dispersed frass.

Life history. Univoltine. Larvae from late October until late November. Adults reared from April to June.

#### Distribution (fig. 543).

Probably throughout the range of *Quercus cerris*, but yet only recorded from northwest Italy, Hungary, and here for the first time from Austria and Yugoslavia.

Material examined: 14  $\delta$ , 13  $\text{♀}$ . — Austria: 6  $\delta$ , 8  $\text{♀}$ , Hof am Leithagebirge, S. of Mannersdorf (Niederöst), 200 m, e.l. 30.iv—14.vi.1984, E. J. van Nieukerken; 2  $\delta$ , 3  $\text{♀}$ , Loretto, 7 km N. Eisenstadt (Burgenland), 240 m, e.l. 30.iv.—8.v.1984, E. J. van Nieukerken (ZMA). — Hungary: 1  $\delta$ , Törökbálint (W. of Budapest), 27.iv.1965, e.l., J. Szócs; 3  $\delta$ , 2  $\text{♀}$ , same data, e.l. 13—24.v.1974 (TMAB). — Italy: 2  $\delta$  (lecto- and paralectotype), Liguria, Ferrania near Altare, e.l. 26.iv.—7.v.1945, J. Klimesch (ZSMK).

Mines. — Austria: Hof am Leithagebirge; Loretto. — Hungary: Törökbálint. — Yugoslavia (Bosna): S. of Han Knežica, 11 km N. of Prijedor.

### 23. *Ectoedemia (Ectoedemia) leucothorax* sp. n.

(figs. 59, 111, 180, 181, 254, 302, 372, 444, 527)

Type material: Holotype  $\delta$ , Spain, Marbella (Málaga), 5.v.1981, C. Gielis, Genitalia slide VU 1892 (ZMA). Paratypes, 2  $\delta$ , 3  $\text{♀}$ . — Spain: 1  $\text{♀}$ , Andalusia, Marbella, L. Monteros, 25 m, 12.vii.1972, E. Traugott-Olsen (ZMC); 1  $\delta$ , Andalusia, Camino de (road to) Ojen, 150 m (Marbella), 25.vi.1983, E. Traugott-Olsen (ETO); 1  $\delta$ , 2  $\text{♀}$ , Estepona, 10-21.vi.1979, Leo Kohonen (ZMUO, ZMA).

Diagnosis: easily recognised by white thorax, orange head and forewing with white streak along dorsal margin, running from base to fascia, and in male absence of hair-pencil. Exter-

nally most similar *caradjai* has a dark thorax and hair-pencil. Male genitalia characterised by very long, slender valvae and aedeagus shorter than capsule or valvae; female genitalia by widened anterior apophyses, shape of T8, hairy abdominal tip, similar signa and smooth bursa.

#### Description.

Male. Forewing length 2.28—2.44 mm (2), wingspan 5.2—6.0 mm. Head: frontal tuft and collar intensively orange. Antennae with 41—42 segments (2). Thorax and tegulae white, except brown outer edge of tegulae; forewings fuscous, with medial arched or interrupted white fascia, united by white streak along dorsal margin to wingbase, occupying 3—4 rows of scales; white pattern in rest position of moth forming anchor-shaped figure. Hindwing without hair-pencil, but with costal bristles.

Female (fig. 59). Forewing length 2.4—2.72 mm (3), wingspan 5.2—6.0 mm. Antennae with 31—32 segments (3).

Male genitalia (figs. 111, 254, 302, 372). Capsule length 304—330  $\mu\text{m}$  (3). Tegumen produced into rounded, approximately triangular, pseuduncus. Gnathos (fig. 302), divided, with narrow spatulate distal part, basal part with serrate margin. Valva (fig. 254) length 279—321  $\mu\text{m}$ , very long and narrow, inner margin completely concave, outer margin completely convex. Aedeagus (fig. 372) 244—279  $\mu\text{m}$  (3), distinctly shorter than capsule or valva, with single pointed carinae, curved outwards.

Female genitalia (figs. 180, 181, 444). T7 with a semicircular patch with about 200 closely set long, smooth setae. T7 and 8 in addition with about 50 shorter setae and a few scales laterally; T8 with posterior margin truncate with prominent corners. Anal papillae broad, with 16 setae. Vestibulum with vaginal sclerite, a dorsal spiculate pouch with many small spicules and a group of densely packed pectinations near entrance of ductus spermathecae. Corpus bursae 620—660  $\mu\text{m}$ , without pectinations; signa similar, 309—339  $\mu\text{m}$ ,  $2.6$ — $3.4 \times$  as long as wide. Ductus spermathecae with 2 convolutions and a prominent vesicle.

Larva unknown.

#### Biology.

Hostplant unknown, but most likely evergreen *Quercus*, judging from its relationships and localities. In the Marbella localities *Quercus suber* or *Q. coccifera* grow. In February 1984 I was not able to collect there any other mines



than those similar to *E. suberis*, but it is possible that *leucothorax* feeds in another season.

Life history. Adults found from early May to early July, all collected at light.

Distribution (fig. 527).

Only known from the Costa del Sol in Spain.

Remarks.

This species shows some similarities with the *suberis* group, but the absence of pectinations in the bursa, the presence of a group of pectinations in the vestibulum, the form of the gnathos and the presence of costal bristles in the male indicate that it in fact belongs to the *subbimaculella* group. The presence of many long setae on the female abdominal tip probably is an adaptation to oviposition on rough surfaces of evergreen oak leaves, and hence a parallel development with *suberis* and *algeriensis*.

#### 24. *Ectoedemia* (*Ectoedemia*) *haraldi*, (Soffner, 1942)

(figs. 60, 112, 182, 255, 303, 374, 445, 487, 545)

*Nepticula haraldi* Soffner, 1942: 56, figs. 1—12. Lectotype ♂ (here designated), France: Angoulême, e.l. v.1941, *Quercus ilex*, ii.1941, Zucht No. 382a, Soffner, Genitalia slide 4776 (MHUB) [examined].

*Stigmella prinophyllella* Le Marchand, 1946: 285. Holotype ♀ [in description as ♂], France: Villenave d'Ornon, Gironde, e.l. 23.v.1928, Le Marchand, Genitalia slide VU 0941 (MNHN) [examined]. (Synonymised by Le Marchand, 1948).

*Stigmella haraldi*; Hering, 1957: 867, fig. 553 (mine); Lhomme, 1963: 1196.

*Ectoedemia* (*Dectirina*) *haraldi*; Klimesch, 1975a: 864, figs. 5, 6 (♂ genitalia).

*Trifurcula* (*Ectoedemia*) *haraldi*; Leraut, 1980: 49.

*Nepticula ilicella* Constant [nomen nudum]. (Synonymised by Klimesch, 1975a: 864.

Diagnosis: externally very similar to *albifasciella* complex and *preisseckeri*, but with generally lighter appearance. *E. ilicis* and *heringella* can be separated by the absence of a costal spot, and androconial scales in male *heringella*. *E. suberis* can be distinguished by the straighter fascia and by the presence of a hair-pencil in male and hairy abdomen tip in female. Females of *andalusiae* are very similar to *haraldi*, and can only be identified with certainty by genitalia. Male genitalia very characteristic by shape of valva with bulgy outer margin. Female genitalia characterised by wide T8 and wide, rounded S8.

Description.

Male. Forewing length 2.88—3.32 mm (3.07

± 0.13, 8), wingspan 6.2—7.1 mm. Head: frontal tuft light yellow to yellowish orange; collar similar. Antennae with 35—42 segments (37.8 ± 2.4, 8). Thorax brown, sometimes mesoscutum with white tip. Forewings brown, with a white dorsal spot in middle, and a costal spot before middle, sometimes united to form a fascia. Hindwing without hair-pencil, but with costal bristles.

Female (fig. 60). Forewing length 2.56—2.88 mm (2.75 ± 0.13, 10), wingspan 5.8—6.5 mm. Antennal segments 27—31 (29.1 ± 1.5, 8). Female distinctly smaller than male.

Male genitalia (figs. 112, 255, 303, 374). Capsule length 266—300 μm (286.3 ± 14.7, 5). Tegumen rounded. Gnathos (fig. 303) with central element divided, distal part truncate, basal part with serrate margin. Valva (fig. 255) length 193—206 μm (201.4 ± 5.2, 5), outer margin bulging distally, inner margin basally straight or convex, from 1/3 distinctly concave, tip pronounced, pointed. Aedeagus (fig. 374) 274—283 μm (279.4 ± 3.6, 5), carinae varying from single to multifurcate.

Female genitalia (figs. 182, 445). T7 with only few short setae along anterior margin of T8, not in distinct rows. T8 with two lateral groups of scales and 3—5 setae each; posterior margin almost straight, lateral corners pronounced, rounded; S8 broadly rounded. Anal papillae with 14—23 setae. Vestibulum with vaginal sclerite, a dorsal spiculate pouch, and a group of densely packed pectinations near the entrance of ductus spermathecae. Corpus bursae 570—825 μm, without pectinations; signa dissimilar, longest 363—577 μm (460 ± 56, 11), shortest 308—495 μm (402 ± 48, 11), 4.0—5.4 × as long as wide. Ductus spermathecae with 2 indistinct convolutions.

Larva. Whitish, opaque, with distinct brown ganglia. Head-capsule and prothoracic plate dark brown. Ventral plates absent.

Biology.

Hostplants: *Quercus ilex* L., *Q. rotundifolia* Lam. and *Q. coccifera* L. Not yet recorded from *Q. suber* L., but probably also feeds on that species.

Mine (fig. 487). Egg on leaf upperside, not against vein. Early mine: slightly contorted narrow gallery, gradually widening, remaining linear throughout. Filled with thick black frass, hardly leaving clear margins. Not always separable from mines of *algeriensis*, *ilicis* or *heringella*.

Life history. Univoltine. Larvae collected in February and March, adults from April to June.

Distribution (fig. 545).

Widespread in southern France, occurring along Atlantic coast up to Angoulême, further recorded from Spain, Portugal, Italy and Greece.

Remarks.

Syntypes of *haraldi* are present in many collections. A lectotype is here designated from the Hering collection in Berlin, since it contains a large number of nepticulid types. The Soffner collection is not housed there.

Marchand incorrectly gave the holotype of *primophylella* as male. He was the first to separate this species from *suberis*, with which it had been confused earlier.

Material examined: 18 ♂, 26 ♀. — France: 4 ♂, 4 ♀ (lecto- and paralectotypes of *haraldi*), Angoulême, e.l. v.1941, *Quercus ilex*, J. Soffner (MHUB, ZMA, ZMC); 1 ♀, Bize, v.1909, Chrétien; 2 ♂, 2 ♀, Alpes marit., Cannes, 13, 15 [decade], Constant (MNHN); 2 ♂, 1 ♀, Golfe Juan, Alpes maritimes, 8—15.vi.1894, Constant (BMNH); 1 ♂, "Nesp." (? near St. Pons, dep. Hérault), 15.vi.1904, Chrétien; 2 ♂, 2 ♀, Roquefort (B. du Rh.), between Cassis and Cuges les Pins, e.l. 14—24.iv.1984, *Quercus ilex*, R. Buvat (ZMA); 1 ♀, Viens (Vaucluse) (near Apt), e.l. 5.v.1971, *Quercus ilex*, R. Buvat (coll. Buvat); 3 ♂, 1 ♀ (holo- and paratypes of *primophylella*), Villenave d'Ornon, Gironde, e.l. 23.v.—1.vi.1928, *Quercus ilex*, Le Marchand (MNHN). — Greece: 1 ♀, Lakonia, 7 km SW Monemvasia, 9.iv.1981, B. Skule (ZMC). — Italy: 3 ♀, Sistiana Mare, 0—60 m, e.l. 6—9.v.1970, *Quercus ilex*, G. Deschka (LNK). — Portugal: 2 ♀, San Fiel, e.l. 20.iv, *Quercus coccifera*, [Mendes], coll. Joannis; 3 ♂, 4 ♀, [prov. Beira Baixa, San Fiel] e.l. 23.iv, *Q. ilex*, [Mendes], coll. Joannis; 1 ♂, (misidentified paralectotype of *ilicis* Mendes) idem, e.l. 22.v. (MNHN). — Spain: 3 ♀, 7 km N. Benahavis (Málaga), road to Ronda, 800 m, e.l. 3—18.iv.1984, *Quercus coccifera*, E. J. van Nieukerken (ZMA).

Mines. — On *Quercus coccifera*. — Spain: 7 km N. Benahavis. On *Quercus ilex*. — France: Angoulême, leg. Soffner (BMNH); between Cassis and Cuges les Pins, leg. Buvat.

## 25. *Ectoedemia (Ectoedemia) ilicis*

(Mendes, 1910) comb. n.

(figs. 61, 113, 183, 256, 257, 304, 375, 446, 488, 489, 543)

*Nepticula ilicis* Mendes, 1910: 164, pl. 7 figs. 7, 8. Lectotype ♂ (here designated), Portugal: [San Fiel, prov. Beira Baixa] e.l. 22.v., *Q. ilex*, [Mendes], Chenille à tête noire, Coll. L. & J. de Joannis,

Genitalia slide VU 1358 (MNHN) [examined].  
*Stigmella ilicis*; Gerasimov, 1952: 243; Hering, 1957: 869 (mine).

Diagnosis: *ilicis* and *heringella* are the only western Palaearctic oak-mining species with dorsal spot only. *Fomoria septembrella* (Stainton), *Stigmella catharticella* (Stainton) and *Zimmermannia* species also have dorsal spot only, but this is situated postmedially, whereas it is medial in *ilicis*. This is also the case in *E. intimella*, but this species can be separated by its unicolorous antennae, uniform dark scales on the forewings, and hair-pencil in the male. See *heringella* for differences with that species. The mines are easily confused with *haraldi*, but adults are easily separated by totally different valva in male and the distinct row of setae on T7 and form of T8 in female of *ilicis*.

Description.

Male (fig. 61). Forewing length 2.48—3.36 mm ( $2.87 \pm 0.25$ , 13), wingspan 5.6—7.2 mm. Head: frontal tuft and collar yellowish orange. Antennae with 31—40 segments ( $37 \pm 2.5$ , 13); scape white, with sometimes some brown scales. Thorax and forewings brown, with a dorsal spot only in medial position, sometimes slightly extending along dorsal margin towards base; sometimes a few scattered white scales present in addition. Hindwing without hair-pencil, but with costal bristles.

Female. Forewing length 2.36—2.88 mm ( $2.68 \pm 0.16$ , 10), wingspan 5.1—6.5 mm. Antennal segments 28—31 ( $30.1 \pm 1.0$ , 8).

Male genitalia (figs. 113, 256, 257, 304, 375). Capsule length 231—244  $\mu\text{m}$  ( $240 \pm 6.1$ , 5). Tegumen broad and rounded. Gnathos (fig. 304) with central element undivided, slightly truncate, lateral margins serrate. Valva (figs. 256, 257) length 176—193  $\mu\text{m}$  ( $183.4 \pm 7.0$ , 5), inner margin basally straight or convex, from 1/3 distinctly concave, inwards pointed tip prominent, truncate. Aedeagus (fig. 375) 253—274  $\mu\text{m}$  ( $264 \pm 9.9$ , 5), carinae split into two or more spines each.

Female genitalia (figs. 183, 446). T7 with a distinct row of 8-14 long setae along anterior margin of T8. T8 with two groups of about 3—6 setae, scales absent; T8 narrow with slightly sinuous posterior margin. Anal papillae with 8-14 setae. Vestibulum with vaginal sclerite, a dorsal spiculate pouch and a group of densely packed pectinations near the entrance of ductus spermathecae. Corpus bursae 660—825  $\mu\text{m}$ ,



without pectinations; signa dissimilar, longest 407—471  $\mu\text{m}$  ( $432.9 \pm 26.9$ , 5), shortest 369—416  $\mu\text{m}$  ( $395.1 \pm 19.3$ , 5),  $3.9$ — $5.1 \times$  as long as wide. Ductus spermathecae with 2 indistinct convolutions.

Larva. Yellow with conspicuous brown ganglia. Head light brown. Ventral plates absent.

#### Biology.

Hostplants: *Quercus ilex* L., *Q. rotundifolia* Lam. and *Q. suber* L. Often sympatric with *haraldi* and *suberis*.

Mine (fig. 488, 489). Egg on leaf upperside, usually against vein. Early mine: much contorted gallery, starting very narrow. Frass black, dispersed, leaving narrow clear margins. Mine seems longer and more contorted than in *haraldi*, but difficult to separate.

Life history. Univoltine. Larvae found in January and February. Adults from March to the end of June.

Distribution (fig. 543).

Clearly west mediterranean.

#### Remarks.

As in the case of *Parafomoria ladaniphila* (Mendes) (Van Nieuwerkerken, 1983: 469) type material of *ilicis* seems no longer to exist in Portugal, but Portuguese material in de Joannis collection (MNHN) can be regarded as syntype material if labelled as *ilicis*. I examined 3  $\delta$  and 1  $\text{f}$  mounted on the same block of pith and labelled "*ilicis* Mendes". One of these males belongs to *haraldi*, but the other specimens are this species. Since Mendes clearly refers in his description to the species with a dorsal spot only, one male of the two is selected lectotype, and the *haraldi* male is regarded as a misidentified paralectotype. Later I found more paralectotypes in the Hering collection in Berlin.

Material examined: 14  $\delta$ , 12  $\text{f}$ . — Algeria: 1  $\delta$ , Batna, 1.v.1903, Walsingham (BMNH). — France: 1  $\text{f}$ , Bize, 30.vi.1910, Chrétien; 1  $\delta$ , 3  $\text{f}$ , "Nesp." (? near St. Pons, dep. Hérault), 15.vi.1904, Chrétien (MNHN). — Portugal: 3  $\delta$ , 2  $\text{f}$  (lecto- and paralectotypes), [San Fiel, prov. Beira Baixa], e.l. 22 + 26.v, *Quercus ilex*, [Mendes] (MNHN, MHUB). — Spain: 1  $\text{f}$ , Sierra de Alfacar (near Granada), 24.iv.1880, Staudinger (MHUB); 1  $\delta$ , Marbella, El Mirador, 100 m, 17.v.1969, E. Traugott-Olsen (ETO); 2  $\text{f}$ , Port Bou, e.l. 29—30.iii.1968, *Quercus ilex*, J. Klimesch (ZSMK); 7  $\delta$ , 3  $\text{f}$ , 4 km NE. Igualeja, Serrania de Ronda (Málaga), 1100 m, e.l. 19.iii—16.iv.1984, *Quercus rotundifolia*, E. J. van Nieuwerkerken; 1  $\delta$ , 1  $\text{f}$ ,

Sierra Blanca, 6 km N. Marbella (Málaga), El Mirador, 800 m, e.l. 17—24.iv.1984, *Quercus rotundifolia* ( $\text{f}$ ) + *Q. suber* ( $\delta$ ), E. J. van Nieuwerkerken (ZMA).

Mines. — On *Quercus rotundifolia*. — Portugal: San Fiel, leg. Mendes (BMNH). — Spain: Serrania de Ronda; Sierra Blanca. On *Quercus suber*: Spain: Sierra Blanca.

Additional record. — France: 1  $\delta$ , 1  $\text{f}$ , Marseille, e.l. 17.v.1971, 27.v.1972, *Quercus ilex*, R. Buvat (R. Johansson, pers. comm.).

### 26. *Ectoedemia* (*Ectoedemia*) *heringella*

(Mariani, 1939) comb. n.

(figs. 62—64, 114, 115, 185, 186, 258, 259, 305, 306, 376, 377, 447, 448, 544)

*Nepticula heringella* Mariani, 1939: 5, 6, fig. 1a, pl. 1.

Lectotype  $\delta$  (here designated), Italy: Sicilia, Partinico, 1.v.1937 [*Quercus ilex*], Mariani (MCST) [examined].

*Nepticula heringella* f. *alliatæ* Mariani, 1939: 7.

*Stigmella heringella*; Hering, 1957: 868, fig. 554 (mine).

Diagnosis: very similar to *ilicis*, but male easily separated (also from most other species) by patches of brown androconial scales on hindwing upperside and forewing underside. Female cannot always be separated with certainty from *ilicis*, but usually *heringella* has some white scales in the region of the costal spot and also has slightly longer signa.

#### Description.

Male (figs. 62, 63). Forewing length 2.08—2.68 mm ( $2.43 \pm 0.13$ , 19), wingspan 4.4—6.0 mm. Head: frontal tuft yellowish white to orange, in specimens from Cyprus fuscous on vertex; collar yellowish white. Antennae with 35—42 segments ( $38.4 \pm 1.8$ , 15); scape with some brown scales in posterior distal corner. Thorax and forewings brown with some scattered white scales; medial dorsal spot white, some white scales along costa, not forming a distinct costal spot; underside of forewings with basally an elongate patch of brown (androconial) scales. Hindwing without hair-pencil, but with costal bristles; in basal half with a patch of brown (androconial) scales on upperside.

Female (fig. 64). Forewing length 2.24—2.60 mm ( $2.44 \pm 0.20$ , 14), wingspan 4.6—5.8 mm. Antennal segments 27—32 ( $29.9 \pm 1.4$ , 16). Without patches of brown scales on underside forewing or upperside hindwing.

Male genitalia (figs. 114, 115, 258, 259, 305, 306, 376, 377). Capsule length 236—283  $\mu\text{m}$  ( $252.9 \pm 16.5$ , 9). Tegumen broad and rounded.



Gnathos (figs. 305, 306) with central element divided, distal part spatulate, basal part with serrate margin. Valva (figs. 258, 259) length 180—223  $\mu\text{m}$  ( $209.0 \pm 17.2$ , 9), inner margin almost straight or concave, tip prominent, slightly truncate. Aedeagus (figs. 376, 377) 257—300  $\mu\text{m}$  ( $274.3 \pm 16.5$ , 9) carinae single, bi- or trifurcate.

Female genitalia (figs. 185, 186, 447, 448). T7 with a distinct row of 8—12 long setae along anterior margin of T8. T8 with two groups of 2—4 setae (7 in Cyprus specimen), without scales, but some scales present in specimen from Corsica; T8 narrow, with slightly sinuous posterior margin. Anal papillae with 8—15 setae. Vestibulum with vaginal sclerite, a dorsal spiculate pouch and a group of densely packed pectinations near the entrance of ductus spermathecae. Corpus bursae 580—715  $\mu\text{m}$ , without pectinations; signa dissimilar, longest 407—583  $\mu\text{m}$  ( $484 \pm 73$ , 5), shortest 353—517  $\mu\text{m}$ , ( $116 \pm 73$ , 5),  $4.0\text{--}4.7 \times$  as long as wide. Ductus spermathecae with 2 indistinct convolutions.

Larva not examined.

#### Biology.

Hostplants: *Quercus ilex* L., *Q. alnifolia* Poech (on Cyprus).

Mine. Egg on leaf upper side, often near vein. Mine: much contorted gallery, almost filled with black frass. Not to be separated from mine of *ilicis*.

Life history. Univoltine. Larvae taken from November to April (Hering, 1957). Adults from late April to the end of June.

#### Distribution (fig. 544).

From Corsica eastwards to Cyprus. Seems to be the eastern vicariant of *E. ilicis*. Not yet recorded from Greece.

#### Remarks.

This species shows some variability. The specimens from Cyprus differ in darker head-colour and some genitalic details, but, since they also have the diagnostic features of *heringella*, I regard these as conspecific with *heringella*. The form *allitatae*, described by Mariani has no taxonomic value, it is probably described from worn specimens.

Material examined: 28  $\delta$ , 26  $\text{♀}$ . — Cyprus: 1  $\delta$ , 1  $\text{♀}$ , Arakapos (Troodos mountains), e.l. 25.iii.1980, *Quercus alnifolia*, B. Gustafsson (RMS). — France: 1

$\delta$ , 1  $\text{♀}$ , Corsica: Corte, 14.vi.1899, Walsingham (BMNH). — Italy: 4  $\delta$ , 3  $\text{♀}$ , Latina, Monti Aurunci, 5 km. N. Itri, 600 m, 24—30.vi.1969, R. Johansson (coll. Johansson); 2  $\text{♀}$  (paralectotypes), Sicilia, Palermo, 8.vi.1928, Mariani; 1  $\delta$ , 1  $\text{♀}$ , idem, e.l. 31.vi.1937, Mariani (MCST); 1  $\delta$ , idem, e.l. 16.vi.1964, W. Glaser (LNK); 5  $\delta$ , 6  $\text{♀}$  (lecto- and paralectotypes), Sicilia, Partinico, 1—11.v.1937, Mariani (MCST, MHUB, ZMC). — Yugoslavia: 12  $\delta$ , 18  $\text{♀}$ , Rijeka, Istria, 100 m, e.l. 6—20.v.1970, *Quercus ilex*, G. Deschka (LNK); 1  $\delta$ , Split, Dalmatia, 19.v.1959, Novak (TMAB); 3  $\delta$ , 4  $\text{♀}$ , Zadar, Dalmatia, 0—60 m, e.l. 13—24.v.1970, *Quercus ilex*, G. Deschka (LNK).

Mines. — On *Quercus alnifolia*. — Cyprus: Arakapos, leg. Gustafsson (RMS). On *Quercus ilex*. — Italy: Sicilia, Taormina, leg. Groschke (BMNH).

#### 27. *Ectoedemia (Ectoedemia) alnifoliae* sp. n. (figs. 65, 187, 188, 449, 546)

*Trifurcula (Ectoedemia)* sp.; Gustafsson, 1981b: 468, fig. 9.

Type material: Holotype  $\text{♀}$ , Cyprus: Troodos, 10.iii.1979, [e.l. 17.iv.1979], *Quercus alnifolia*, [B. Gustafsson], Genitalia slide RMS 6572 (RMS). Mine from which holotype emerged examined.

Diagnosis: externally similar to *nigrosparsella*, but light scales not intensively yellow, and scape with scattered brown scales. Female genitalia without long spiraled ductus spermathecae, with only 3 narrow convolutions.

#### Description.

Male unknown.

Female holotype (fig. 65). Forewing length 2.88 mm, wingspan 6.6 mm. Head: frontal tuft orange, darker on vertex, collar yellowish. Antennae broken, scape white with some brown scales. Thorax and forewings dark brown, irrorate with some yellowish-white scales, no colour pattern present.

Female genitalia (figs. 187, 188, 449). T7 without a row of setae. T8 with two lateral groups of scales and approximately 5 setae each. Anal papillae with 15—18 setae. Vestibulum with vaginal sclerite, a prominent dorsal spiculate pouch, and a group of densely packed pectinations near entrance of ductus spermathecae. Corpus bursae 690  $\mu\text{m}$ , without pectinations; signa dissimilar, longest 540  $\mu\text{m}$ , shorter 440  $\mu\text{m}$ ,  $4.0 \times$  as long as wide. Ductus spermathecae with 2 narrow convolutions.

Larva not examined.

**Biology.**

Hostplant: *Quercus alnifolia* Poech, an ever-green oak.

Mine. Egg on leaf underside. Mine starting as narrow gallery, suddenly enlarging into large blotch against leaf margin, frass not visible in single mine examined. See also Gustafsson (1981b: 469, fig. 9C).

Life history. Larva taken in March, adult emerged in April.

**Distribution (fig. 546).**

Troödos mountains on Cyprus.

**Remarks.**

Although only one female was available, this species is here described as new, since it shows sufficient diagnostic characters to separate it from other species, and the identity of males of this species can easily be determined by host-plant, mine-form and locality.

**28. Ectoedemia (Ectoedemia) nigrosarsella**

(Klimesch, 1940)

(figs. 66, 116, 189, 190, 260, 307, 378, 450, 491, 546)

*Nepticula nigrosarsella* Klimesch, 1940a: 91, pl. 14, figs. 8, 9, pl. 15, figs. 10—12. Lectotype ♂ (here designated). Italy: Teriolis merid., Naturno, near Merano, c.l. iv.1939, J. Klimesch, Genitalia slide 449/39 Hering (MHUB) [examined].

*Stigmella nigrosarsella*; Klimesch, 1951: 64; Hering, 1957: 869, fig. 543.(mine); Klimesch, 1961: 763.

*Ectoedemia nigrosarsella*; Kasy, 1983: 5.

Diagnosis: characterised by brown irrorate with yellow forewings and absence of hair-pencil in male. Male genitalia not separable from *albifasciella* complex. Female genitalia characterised by long spiraled ductus spermathecae, with 13½—14 convolutions, whereas *contorta* usually has 10½—12 convolutions (except one specimen).

**Description.**

Male. Forewing length 2.0—2.68 mm (2.43 ± 0.19, 9), wingspan 4.3—6.0 mm. Head: frontal tuft ferruginous, sometimes mixed with fuscous; collar similar. Antennae with 28—37 segments (32.5 ± 3.2, 6). Thorax and forewings brown irrorate with light yellow scales, being a more pronounced yellow than in most other species; colour pattern absent, but light scales predominant at tornus. Hindwing without hair-pencil, but with costal bristles.

Female (fig. 66). Forewing length 2.72—2.88

mm (2.79 ± 0.07, 4), wingspan 6.0—6.4 mm. Antennal segments 25—27 (2.8 ± 1.0, 4).

Male genitalia (figs. 116, 260, 307, 378). Capsule length 283—309 μm, (3). Tegumen rounded. Gnathos (fig. 307) with central element truncate, as cut off. Valva (fig. 260) length 206—223 μm (4), inner margin strongly convex, except apically, serrate by prominent setal sockets, tip pointed; dorsal surface with many setae. Aedeagus (fig. 378) 279—287 μm (4), carinae pointed, single.

Female genitalia (figs. 189, 190, 450). T7 with a row of 8—12 setae along posterior margin; T8 with two lateral groups of scales and 2—4 setae each. Anal papillae with 14—17 setae. Vestibulum with vaginal sclerite, a dorsal spiculate pouch, and a group of densely packed pectinations near entrance of ductus spermathecae. Corpus bursae 740—825 μm, without pectinations; signa dissimilar, longest 485—695 μm (3), shortest 450—458 μm, 4.1—4.4 × as long as wide (3). Ductus spermathecae with very prominent spirals inner canal, with 13½—14 convolutions.

Larva. Yellow, with greenish tinge in younger larvae, head-capsule brown. In penultimate instars with conspicuous brown ventral plates, which are shed during final instar; thereafter the ganglia become visible.

**Biology.**

Hostplants: *Quercus pubescens* Willd., occasionally on *Q. petraea* (Mattuschka) Liebl. (Klimesch, 1951).

Mine (fig. 491). Egg on leaf underside, occasionally on upperside. Early mine highly contorted, forming brown blot with irregularly accumulated brown frass; later gallery less contorted, with brown dispersed or coiled frass, leaving narrow clear margins. Mine confined to small area, often near leaf-margin.

Life history. Univoltine, larvae occurring from mid October to November. Adults collected at light mid June, reared in April and May (forced).

**Distribution (fig. 546).**

Known from a limited number of localities in Czechoslovakia, Hungary, Austria, Italy and France. Usually occurs in exposed southern slopes on calcareous soil — the typical habitat for *Q. pubescens*.

Material examined: 15 ♂, 13 ♀. — Austria: 2 ♂, Gumpoldskirchen, Glaslatterriegel, 10.vi.1983, F.

Kasy (NMW); 4 ♂, 5 ♀, *ibid.*, e.l. 25.iv.—2.v.1984, *Quercus pubescens*, E. J. van Nieukerken (ZMA); 1 ♂, Hundsheimer Berg, Porta Hungarica (near Hainburg), 19.vi.1976, F. Kasy (NMW). — France: 2 ♀, Aubagne (Bouches du Rhône), e.l. 10—17.v.1977, *Quercus pubescens*, Buvat (coll. Buvat). — Hungary: 4 ♂, 2 ♀, Törökbalint (W. of Budapest), e.l. 10—18.iv.1974, 16.v.1976, *Q. pubescens*, J. Szöcs (TMAB). — Italy: 1 ♂, 1 ♀ (lecto- and paralectotype), Naturno near Merano, e.l. iv.1939, J. Klimesch (MHUB); 3 ♂, 3 ♀, Trento, Sardagna, 500 m, e.l. iv.1946, *Q. pubescens*, J. Klimesch (MHUB, ZMA).

Mines. — Austria: Gumpoldskirchen; Hainburg; Loretto; Wien, Leopoldsberg. — Italy: Naturno, leg. Klimesch; Trento, leg. Klimesch (BMNH).

### The *Ectoedemia albifasciella* complex

This is a complex of four sibling species comparable with the *subbimaculella* complex, but differing in so far that the species are well separable on the female genitalia, the number of convolutions of the ductus spermathecae being a good and constant character in this complex: *albifasciella* with  $2\frac{1}{4}$ — $2\frac{3}{4}$ , *cerris*  $3\frac{1}{2}$ —4, *pubescivora* 5—6 and *contorta* with  $10\frac{1}{2}$ —12 ( $13\frac{1}{2}$ ) convolutions. The externals and male genitalia do not provide any diagnostic characters. The species seem to have a different food-plant choice: *albifasciella* on *Quercus robur* and *Q. petraea*, *pubescivora* and *contorta* on *Q. pubescens* and *cerris* on *Q. cerris*, on which only one exception is known. Only *E. albifasciella* is described fully, the other species only as far as they differ.

### 29. *Ectoedemia (Ectoedemia) albifasciella* (Heinemann, 1871)

(figs. 6, 67, 117, 191, 192, 261, 308, 309, 379, 416, 451, 490, 522)

*Nepticula albifasciella* Heinemann, 1871: 222. 2 Syn-types, Germany, West: Braunschweig, e.l. *Quercus*, Heinemann (depository unknown) [not examined].

[*Nepticula argyropeza*; Stainton, 1854: 300 (partim, imago only); 1859: 433; 1862: 188—191, pl. 9, fig. 2 m (imago); Meyrick, 1895: 726, misidentification.]

*Nepticula subapicella* Stainton, 1886: 238. Lectotype ♂ (here designated), England: Beckenham, Palings, 17.vi.[18]51, S 7609, 57, Stainton, Genitalia slide BMNH 22609 (BMNH) [examined] (Synonymised by Emmet, 1974b: 274—276).

*Nepticula albifasciella*; Heinemann & Wocke, 1877: 769; Snellen 1882: 1002; Sorhagen, 1886: 312; Waters, 1928: 248—251 (redescription, biology); Petersen, 1930: 77; fig. 121bis (♂ genitalia); Klimesch, 1936: 210; Szöcs, 1965: 84.

*Nepticula subbimaculella* var. *albifasciella*; Rebel, 1901: 228; Meess, 1910: 481.

*Dechtria albifasciella*; Beirne, 1945: 205, fig. 65 (♂ genitalia); Emmet, 1971: 246, 247.

*Stigmella albifasciella*; Klimesch, 1951: 66; Gerasimov, 1952: 224; Klimesch, 1961: 762; Lhomme, 1963: 1204; Borkowski, 1969: 110.

*Stigmella (Dechtria) albifasciella*; Hering, 1957: 867 (mine).

*Trifurcula (Ectoedemia) albifasciella*; Johansson, 1971: 245.

*Ectoedemia (Dechtria) albifasciella*; Borkowski, 1972: fig. 13 (venation).

*Ectoedemia albifasciella*; Bradley et al., 1972: 3; Borkowski, 1975: 491; Emmet, 1976: 199, pl. 6 fig. 10, pl. 12 fig. 30.

*Trifurcula albifasciella*; Karsholt & Nielsen, 1976: 18.

[*Dechtria argyropeza*; Beirne, 1945: 205, fig. 66 (♂ genitalia) misidentification.]

Diagnosis: only separable from the other members of the complex in the female sex, by the lower number of convolutions in the ductus spermathecae. Externally also very similar to *preisseckeri* and *haraldi*, which can however easily be separated on genitalia (see there). Distinguished from *E. subbimaculella* complex by absence of basal spot, truncate gnathos and single carinae in male and wider convolutions of ductus spermathecae in female. Other species with white costal and dorsal spot (not metallic) have these spots opposite, or forming an almost straight fascia, and a hair-pencil in male. *E. erythrogenerella* has a similar pattern, but metallic silver spots.

### Description.

Male. Forewing length 2.32—2.96 mm ( $2.68 \pm 0.17$ , 23), wingspan 5.2—6.4 mm. Head: frontal tuft and collar uniformly orange to ferruginous. Antennae with 34—41 segments ( $36.4 \pm 1.9$ , 19). Thorax blackish fuscous, with a few white scales at tip of mesoscutum and tegulae. Forewings blackish fuscous, with a white dorsal spot in middle and a costal spot before middle, sometimes united to form a fascia. Hindwing without hair-pencil, but with costal bristles.

Female (fig. 67). Forewing length 2.32—2.92 mm ( $2.67 \pm 0.18$ , 24), wingspan 5.2—6.5 mm. Antennal segments 25—28 ( $26.3 \pm 1.0$ , 23).

Male genitalia (figs. 117, 261, 308, 309, 379). Capsule length 244—321  $\mu\text{m}$  ( $292.1 \pm 18.5$ , 13). Tegumen distinctly produced into almost triangular, rounded pseuduncus. Gnathos (fig. 308, 309) with central element parallel-sided, with blunt, truncate tip. Valva (fig. 261) length 180—



236  $\mu\text{m}$  ( $220.1 \pm 14.1$ , 14), apically distinctly narrowed into pointed tip; inner margin strongly convex, becoming concave near tip, serrate by prominent sockets of numerous setae on inner and dorsal surfaces. Aedeagus (fig. 379) 236—313  $\mu\text{m}$  ( $275.8 \pm 20.1$ , 14), carinae pointed, single.

Female genitalia (figs. 191, 192, 416, 451). T7 with a row of 6–12 setae along posterior margin; T8 with two lateral groups of scales and 2–6 setae each; S8 almost quadrate, with parallel sides. Anal papillae with 13–29 setae. Vestibulum with vaginal sclerite, a dorsal spiculate pouch, and a group of densely packed pectinations near entrance of ductus spermathecae. Corpus bursae 660—825  $\mu\text{m}$ , without pectinations; signa dissimilar, longest 460—560  $\mu\text{m}$  ( $519 \pm 34.7$ , 10), shortest 395—530 ( $473 \pm 39.0$ , 11),  $4.9$ — $7.5 \times$  as long as wide. Ductus spermathecae with  $2\frac{1}{4}$ — $2\frac{3}{4}$  convolutions, the convolutions being very wide and prominent (fig. 416).

Larva. Yellowish white with light brown head-capsule, inconspicuous ganglia. Penultimate instars with indistinct brown ventral plates.

#### Biology.

Host plants: *Quercus robur* L., and *Q. petraea* (Mattuschka) Liebl. Occurs on several other deciduous oaks in botanical gardens, and occasionally on *Castanea sativa*.

Mine (fig. 490). Egg on upperside beside vein, or midrib. Mine starting as narrow linear gallery, often along midrib and later following lateral vein outwards, abruptly changing into almost rectangular blotch; sometimes blotch takes form of wide, irregular gallery. Early mine with linear frass, in blotch frass in basal half.

Life history. Univoltine, larvae from end of August until October, usually much earlier than *heringi* and *subbimaculella*, but occasionally still feeding in green islands in late October; adults flying in May and June.

#### Distribution (fig. 522).

Widely distributed in Central and North Europe, apparently occurring farther northwards than *subbimaculella* and *heringi*. In Scandinavia as far north as the limit of *Quercus* in southern Finland and north of Stockholm in Sweden. Not yet recorded from Norway, but presumably occurring along the south coast. Common in Great-Britain as far north as the Scottish High-

lands. The distribution in the south is hardly known, due to confusion with other species of the complex. *E. albifasciella* is there with certainty known from Austria, Hungary and central Greece (Pindhos mountains).

#### Remarks.

This species has been the subject of much confusion. Stainton (1854, 1859, 1862) misidentified it as *E. argyropeza* Zeller, and incorrectly equated the immature stages with those of the real *argyropeza*. The imago of *argyropeza* he described as *apicella* Stainton (see under *E. argyropeza*). By 1863 Stainton was aware of this incongruency, but did not settle the problem, since he thought that Fritsche was going to publish the solution (Stainton, 1886; Emmet, 1974b). Not until 1886 did he propose the name *subapicella* for the adults he had previously described as *argyropeza* Zeller, still without knowing the life-history. I have studied three specimens from the Stainton collection, labelled as *argyropeza* which he presumably used for his description of *argyropeza* and, hence, *subapicella*. From these specimens I selected a lectotype of *subapicella*.

Although Heinemann (1871) also noted Stainton's misinterpretation of *argyropeza*, he did not link it up with the new species which he reared from oak, and described as *albifasciella*. In the Niedersächsisches Landesmuseum Hannover, there is no material of this species left in the Heinemann collection (pers. comm. R. Johansson), neither in the Berlin or Leningrad museums. However, the clear description, with the note on the foodplant, and the type-locality (Braunschweig) make it most likely that the present interpretation of *albifasciella* is correct. Waters (1928) was the first to describe the biology of *albifasciella* in detail, and to separate it from *subbimaculella*. Since that time mines and larvae were still often confused with *heringi* (described in 1934), and in southern Europe with the other species of the complex.

I have only seen correct *albifasciella* females reared from *Quercus robur* and *Q. petraea*, all specimens reared from *Q. pubescens* appear to belong to either *E. pubescivora* or *contorta*. However, as this refers to comparatively few specimens, it cannot definitively be concluded that these species are completely host-specific.

Material examined: 128  $\sigma$ , 109  $\rho$ , 23 ex. — Austria: 1  $\sigma$ , Klosterneuburg, Freiberg, 9.v.1932, Preis-

secker; 3 ♀, Klosterneuburg, Buchberg, e.l. 8—16.v.1942, *Q. robur*, Preisseecker (NMW); 1 ♂, 1 ♀, 5 km W. Völkermarkt, Pörschach (Kärnten), e.l. 27—30.iv.1984, *Quercus robur*, J. J. Boomsma & E. J. van Nieukerken (ZMA). — France: 1 ♂, Pontault, 18.v.1977, Leraut (coll. Leraut). — Germany, West: 1 ♂, Rohr (Württemberg), e.l. 18.iii.1934, Würz (LNK); 1 ♂, Schwabisch Hall, 13.vi.1978, W. Speidel (coll. Speidel). — Germany, East: 2 ♂, Berlin, Finckenkrug, 15.v.1923, 22.v.1930, Hering; 1 ♂, 3 ♀, Nordhausen, 24—29.v.1898, Petry (MHUB). — Great Britain: 3 ♂ (lecto- and paralectotypes of *subapicella*), Beckenham, Palings, 17 + 22.v.1851, Stainton (BMNH); 1 ♀, Saffron Walden, e.l. 25.v.1980, Bryan, Emmet & van Nieukerken; 1 ♀, Southampton, 15.vi.1935, Fassnidge (ZMA); 2 ♂, no locality, 8.v.1884, Stevens; 3 ♂, 5 ♀, no further data, Walsingham (BMNH). — Greece: 1 ♂, 2 ♀, Palaiokastron, Evritania, 1200 m, e.l. 8—13.v.1981, *Quercus petraea* s.l. 21.ix.1980, Menken & van Nieukerken (ZMA). — Hungary: 1 ♀, Budapest, Petneházi-rét, e.l. 20.v.1979, *Q. petraea*, J. Szócs; 1 ♂, 1 ♀, Mátra Hegység, Sástó, e.l. 12 + 14.v.1973, *Q. petraea*, *Q. robur*, J. Szócs (TMAB). — Netherlands: 98 ♂, 78 ♀, 23 ex. from following localities: Aerdenhout, Arnhem, Bergen op Zoom, Breda, Bussum, Doetinchem, Driessum, Epen, Groesbeek, Den Haag, Helvoirt, Hilversum, Hoge Veluwe near Deelen, Hollandse Rading, Horst, Hulshorst, Leeuwarden, Leuvenum, Loenen (Gld.), De Lutte, Nunspeet, Oosterbeek, Overberg, Overveen, Rhenen, Rockanje, Rotterdam, Rijs, Santpoort, Tietjerk, Ubbergen, Vaals, Venlo, Wageningen, Wassenaar, Winterswijk, Zandvoort (RMNH, ZMA, AFW, coll. Huisman, coll. Kuchlein). — Poland: 3 ♂, Dąbie (Alt Damm), 11.iv.1930, Krone (TMAB); 5 ♂, 10 ♀, Krosno Odr. (Crossen a. Oder), e.l. 18.v—10.vi.1930, *Quercus robur*, Hering; 2 ♂, Osiecznica (Güntersberg O.), near Krosno, 6.vi.1915, Hering (MHUB). — Switzerland: 1 ♀, Lussy (VD), LS 05A, e.l. 10.vi.1977, S. E. Whitebread (coll. Whitebread).

Mines. — On *Castanea sativa*. — Great Britain: Reading. On *Quercus petraea* and *robur*. — Austria: Hof am Leithagebirge; Hundsheimer Berg near Hainburg; Völkermarkt. — Belgium: Zolder. — France: Andlau. — Germany, West: Blankenheim; Wiesbaum. — Great Britain: Little Waltham; Reading; Redhill. — Greece: W. of Palaiokastron, Evritania. — Italy: Tolmezzo. — Netherlands: many localities.

Males of *albifasciella*-complex with uncertain identity. 5 ♂. — Spain: 1 ♂, San Ildelfonso (La Granja), 22.vi.1902, Chrétién (MNHN); 1 ♂, Sierra de Alfacar, 24.iv.1880, Staudinger (MHUB). — Turkey: 1 ♂, Asia minor, SW of Yalova, Sea of Marmara, 11.v.1969, Kasy (NMW). — USSR: 1 ♂, Krasnoarmeysk (Sarepta), 22.v.1859, Christoph (BMNH). — Yugoslavia: 1 ♂, Drenovo, near Kavadarci (Macedonia), 20—30.v.1957, Kasy (NMW).

### 30. *Ectoedemia (Ectoedemia) cerris*

(Zimmermann, 1944)

(figs. 68, 118, 193, 194, 262, 310, 380, 452, 492, 548)

*Nepticula cerris* Zimmermann, 1944: 121. Lectotype ♀ (here designated), Czechoslovakia: Moravia merid., Lednice (Eisgrub), F. Zimmermann, Genitalia slide VU 1333 (MHUB) [examined].

*Nepticula* sp.; Skala, 1942: 6, 7, figs. 1, 2 (description of species, later named *montissancti*).

*Nepticula montissancti* Skala, 1948: 121, 122. Holotype, Czechoslovakia: Mikulov (Nikolsburg), v. 1943, e.l., *Quercus cerris* (Skala) (lost) [not examined]. **Syn. nov.**

*Stigmella (Dechthiria) cerris*; Hering, 1957: 866, fig. 555 (mine).

*Nepticula (Dechthiria) cerris*; Szócs, 1968: 227.

*Ectoedemia cerris*; Szócs, 1978: 266; 1981: 210.

Diagnosis: separated from the other members of the complex by the ductus spermathecae of the female, with 3½—4 convolutions.

#### Description.

Male. Forewing length 2.24—2.28 mm (3), wingspan ± 5.0 mm. Antennae with 32–34 (3) segments. Similar to *albifasciella*, fascia generally broken.

Female (fig. 68). Forewing length 2.32—2.4 mm (5). Wingspan 5.2—5.3 mm. Antennae with 25—28 segments (4).

Male genitalia (figs. 118, 262, 310, 380). As *albifasciella*. Capsule 250—285 µm (2); valva 200—205 µm (2); aedeagus 245—250 µm (2).

Female genitalia (figs. 193, 194, 452). T7 with a row of 6 setae; T8 with 3—6 setae on each side. Anal papillae with 8—13 setae. Corpus bursae 790—860 µm; longest signum 462—560 (4), shortest 418—540 (4), 5.4—7 × as wide as long. Ductus spermathecae with 3½—4 convolutions.

Larva. Whitish, with dark head-capsule and conspicuous black ventral plates which are shed during final instar.

#### Biology.

Hostplant: *Quercus cerris* L.

Mine (fig. 492). Egg on upper side, on or near vein. Early mine narrow gallery, following vein or contorted, with broken linear frass; suddenly widening into large blotch, in which frass is accumulated near opening. Mine often away from the midrib.

Life history. Univoltine. Larvae have been found from late September to the end of October, but most plentiful in early October. The adults appeared in May.

#### Distribution (fig. 548).

Known from Hungary, Moravia, eastern Austria, Italy and Yugoslavia.



## Remarks.

Skala (1948) described *montissancti* as a third species on *Quercus cerris*, separate from *cerris* and *liechtensteini*, but his description of mine and adult clearly indicate that he was describing *cerris* again, hence the synonymy. The holotype was according to Skala himself destroyed by psocids. *E. cerris* is in the autumn the earliest *Ectoedemia* species mining on *Q. cerris*. In the first week of October 1983 we found many feeding larvae in Austria, but no other *Ectoedemia* species, whereas in the last week of October, on the same localities almost only empty mines were found between many larvae of *liechtensteini* and *gilvipennella*.

Material examined: 7 ♂, 13 ♀. — Austria: 5 ♀, Hof am Leithagebirge, S. of Mannersdorf (Niederöst), e.l. 3—7.v.1984, J. J. Boomisma & E. J. van Nieuwerkerken; 1 ♀, Wien, Kahlenberg, SE, 400 m, e.l. 3.v.1984, E. J. van Nieuwerkerken (ZMA). — Czechoslovakia: ♀ lectotype, see above. — Hungary: 1 ♂, Budaörs, Csiki-hegyek, e.l. 14.v.1971, Q. *cerris*, J. Szócs; 2 ♂, 4 ♀, Szár, Q. *cerris*, e.l. 1.v.1965, 20.iv.1966, 1.v.1966, 18—19.v.1968, J. Szócs; 1 ♂, Törökbalint, e.l. 15.v.1965, J. Szócs (TMAB). — Italy: 2 ♂, P. N. d'Abruzzo, Opi, Bivio, la Camosciara (L'Aquila), e.l. 5—7.v.1984, S. B. J. Menken; 1 ♂, 2 ♀, between Tolfa-Allumiere (Roma), e.l. 9—16.v.1984, S. B. J. Menken (ZMA).

Mines. — Austria: Hof am Leithagebirge; Eisenstadt; Loretto, N. of Eisenstadt; Wien, Kahlenberg; — Hungary: Törökbalint. — Italy: Opi; Sabaudia; Tolfa; Veio. — Yugoslavia: S. of Han Knežica, N. of Prijedor.

31. *Ectoedemia (Ectoedemia) pubescivora*

(Weber, 1937) comb. n.

(figs. 69, 119, 195, 196, 263, 311, 381, 453, 493, 547)

*Nepticula pubescivora* Weber, 1937b: 212, fig. 2. Lectotype ♀ (here designated), Switzerland: Somazzo, 12.x.1932, *Querc. cerris* (sic!), Weber, Genitalia slide ETH 1236 (ETHZ) [examined].

*Stigmella pubescivora*; Klimesch, 1948: 73, 74, figs. 52—54 (♂ genitalia); Klimesch, 1951: 65; Hering, 1957: 870, fig. 547 (mine).

*Trifurcula (Ectoedemia) pubescivora*; Kasy, 1978: 4.

Diagnosis: separated from the other members of the complex by the ductus spermathecae in the female, with 6 wide convolutions.

## Description.

Male. Forewing length 2.24—2.56 mm (2.45 ± 0.13, 5), wingspan 5.0—5.8 mm. Antennae with 34—35 (3) segments. Further as *albifasciella*.

Female (fig. 69). Forewing length 2.4—2.76

mm (2.55 ± 0.11, 9), wingspan 5.2—6.0 mm. Antennae with 25—27 segments (25.7 ± 0.8, 7).

Male genitalia (figs. 119, 263, 311, 381). As *albifasciella*. Capsule 270—300 μm (3); valva 223—236 μm (3); aedeagus 253—274 μm (3).

Female genitalia (figs. 195, 196, 453). T7 with a row of 6—10 setae; T8 with 2—5 setae on each side. Anal papillae with 10—17 setae. Corpus bursae 680—935 μm; longest signum 430—650 μm (543 ± 46, 14), shortest 395—550 μm (485 ± 43, 14), 4.3—6 × as long as wide. Ductus spermathecae with 5—6 very wide convolutions.

Larva. As in *cerris*, with black ventral plates.

## Biology.

Host plant: *Quercus pubescens* Willd. The specimens in the type-series are labelled *Q. cerris*, but Weber refers clearly to *pubescens* in his description.

Mine (fig. 493). Egg on either surface of leaf. Mine largely as in *albifasciella*, but both linear part and blotch part often more contorted, and blotch often more forming wide gallery.

Life history. Univoltine. Larvae of the type-series have been found in mid October, adults were reared or collected in late May or first half of June.

## Distribution (fig. 547).

With certainty only known from the material examined. The records of mines on *Quercus pubescens* from France and Italy are probably correct. Other records are doubtful, and not included here.

Material examined: 9 ♂, 20 ♀. — France: 2 ♀, "Nesp." (? near St. Pons, dep. Hérault), 15.vi.1904, Chrétien (MNHN); 2 ♀, Viens (Vaucluse) (near Apt), e.l. 16—17.v.1979, *Quercus pubescens*, Buvat (coll. Buvat). — Italy: 3 ♂, 5 ♀, Sardegna, Belvi, environs, 700 m, 29.v—15.vi.1975, F. Hartig (MRST); 4 ♀, Sardegna, Gennargentu, Belvi, 800 m, 19.v.1976, G. Derra (coll. Derra): 4 ♂, 5 ♀, [Sicilia, Taormina], 572, Groschke (SMNS). — Switzerland: 2 ♂, 2 ♀ (lecto- and paralectotypes), Somazzo, Monte Generoso, mines 12.x.1932, Weber (ETHZ).

Mines. — France: Aix-en-Provence; Viens (Vaucluse), leg. Buvat. — Italy: Abruzzi: Alfredena; Goia dei Marsi; Sicilia, Taormina, leg. Groschke (BMNH). — Switzerland: Astano, leg. + coll. Whitebread; Somazzo, leg. Weber (ETHZ); idem, leg. + coll. Whitebread.

32. *Ectoedemia (Ectoedemia) contorta* sp. n.

(figs. 70, 120, 197, 198, 312, 382, 454, 547)

*Ectoedemia* spec.; Van Nieuwerkerken in Kasy, 1983: 5.



*Ectoedemia cf albifasciella*; Van Nieukerken in Kasy, 1983: 5.

Type material: Holotype ♀, Hungary: Budaörs, Csiki-hegyek, *Quercus pubescens*, e.l. 6.v.1966, J. Szöcs, Genitalia slide VU 1388 (TMAB). Paratypes, 8 ♀. — Austria: 1 ♀, Hundsheimer Berg, Porta Hungarica (near Hainburg), 19.vi.1976, F. Kasy; 1 ♀, Leithagebirge, N. Burgenland, Zeilerberg S., 30.v.1964, Kasy & Vartian (NMW). — Hungary: 1 ♀, C̄sopak, 3.v.1971, *Q. pubescens*, J. Szöcs; 1 ♀, Északborsodi-karszt, Haragistya, e.l. 3.v.1965, *Q. pubescens*, J. Szöcs; 1 ♀, Mátra Hegység, Sástó, e.l. 16.v.1973, *Q. robur*, J. Szöcs; 3 ♀, Nagykovácsi, Kis Szénás (W. of Budapest), e.l. 14—15.v.1964, *Q. pubescens*, J. Szöcs (TMAB, ZMA).

Other material: 4 ♂, probably belonging to *contorta*. — Austria: 2 ♂, Hundsheimer Berg (near Hainburg), 17.vi + 8.vii.1980, F. Kasy (NMW). — Hungary: 1 ♂, Budaörs. Csiki-hegyek, e.l. 10.v.1966, *Q. pubescens*, J. Szöcs; 1 ♂, Nagykovácsi, Kis Szénás, e.l. 8.v.1964, *Q. pubescens*, J. Szöcs (TMAB).

Diagnosis: easily separated from other females in the species complex by the long spiraled ductus spermathecae, with 10½—13½ convolutions. *E. nigroparsella* has a similar ductus, but has a very different wing pattern.

#### Description.

Female (fig. 70). Forewing length: 1.84—2.56 (2.24 ± 0.21, 9), wingspan 4.6—5.4 mm. Antennae with 22—26 segments (24 ± 1.2, 9). Further as *albifasciella*.

Male. Forewing length 2.36—2.48 mm, wingspan 5.2—5.6 mm. Antennae with 32—35 segments.

Female genitalia (figs. 197, 198, 454). T7 with a row of 10—12 setae; T8 with 2—5 setae on each side. Anal papillae with 9—21 setae. Corpus bursae 715—925 µm; long signum 460—585 µm (520 ± 52.2, 8), short 430—550 µm (487 ± 54.1, 8). Ductus spermathecae with 10½—12 (in 1 specimen 13½) convolutions. Further as *albifasciella*.

Male genitalia (figs. 120, 264, 312, 382). Similar to *albifasciella*. Capsule length 257—278 µm. Valva 210—227 µm. Aedeagus 257—278 µm.

Larva not examined.

#### Biology.

Hostplants: *Quercus pubescens* Willd. One specimen reared from *Q. robur* L.

Mine unknown, but since all specimens reared were identified by Szöcs as *albifasciella*, it probably is very similar to the mine of *albifasciella*.

Life history. Univoltine. Adults reared or collected in May, June, and early July. Larvae collected in autumn, but exact data unknown.

Distribution (fig. 547).

At present only known from eastern Austria and Hungary.

#### Remarks.

This species was discovered amongst material identified as *albifasciella*. All specimens reared by Szöcs from *Quercus pubescens* appear to belong to *contorta*, and all but one reared from *Q. robur* and *Q. petraea* are the real *albifasciella*. Only one *contorta* has been reared from *Q. robur*. Also the Austrian localities have dense stands of *Q. pubescens*, so it seems likely that *E. contorta* is restricted to this oak, and an eastern vicariant of *E. pubescivora*.

As in the other species of this complex, only the females can be identified with certainty, therefore the males are excluded from the type-series, and the order of description is changed accordingly.

#### The *Ectoedemia subbimaculella* complex

The complex of species around *E. subbimaculella* is one of the most difficult species complexes in Nepticulidae, and not completely understood. Externally all these species are extremely similar, and show only slight differences in head-colour and size. The male genitalia do not provide constant diagnostic characters and the female genitalia only show minute differences to separate *subbimaculella* from other species. More than one species has been described because of differences in larval habit and foodplant choice. The larva of *E. subbimaculella* invariably slits its mine open during its last instar, and the larva of *E. phyllotomella* cuts out a circular disc at the end of its mine. The other species in this complex, without having such peculiarities, have been described because they feed on different species of *Quercus*, or *Castanea*, viz. *heringi* and *quercifoliae* on *Q. robur*, and *Q. petraea*, *zimmermanni* on *Q. pubescens*, *liechtensteini* on *Q. cerris* and *sativella* on *Castanea sativa*. In my experience the larvae found on *Q. robur*, *Q. petraea*, *Q. pubescens* and *Castanea* do not show any difference, but larvae collected on *Q. cerris* are very

different in colour, agreeing with the description of *liechtensteini*. Similar larvae, however, have also been collected in low number on *Q. pubescens* and *Q. petraea*, together with the commoner type, so that food plant difference does not seem to be constant. By electrophoresis of allozymes there is indication of some isolation in the following species, but in contrast with other situations no diagnostic enzymes have been found: *subbimaculella*, "heringi" from *Q. robur* and *Q. pubescens* and *liechtensteini* from *Q. cerris* and *Q. pubescens* (Menken, in preparation). On the ground that the larvae from *Castanea* and *Q. pubescens* do not show differences from those from *Q. robur*, *zimmermanni*, *sativella* and *quercifoliae* are considered provisionally to be synonymous with *heringi*. This hypothesis is open to further tests. Hereafter only *E. subbimaculella* is described fully, and the other species only in so far as they differ from it.

### 33. *Ectoedemia (Ectoedemia) subbimaculella* (Haworth, 1828)

(figs. 71, 121, 199, 200, 265, 313, 384, 417, 455, 494, 523)

*Tinea subbimaculella* Haworth, 1828: 583. Lectotype ♂ (here designated), [England], Haworth Coll.; Stainton Coll., Genitalia slide BM 22595 (BMNH) [examined].

*Microsetia nigrociliella* Stephens, 1829: 208 [nomen nudum].

*Microsetia nigrociliella* Stephens, 1834: 267. Lectotype ♂ (here designated), [England], Stephens coll., Genitalia slide BM 22599 (BMNH) [examined]. *Syn. nov.*

*Nepticula cursoriella* Zeller, 1848: 326. Holotype ♀, Germany: Frankfurt am Main; Heyden (depository unknown) [not examined].

*Microsetia subbimaculella*; Stephens, 1829: 208; 1834: 267.

*Nepticula subbimaculella*; Stainton, 1849: 29; 1854: 300; 1855: 258—271, pl. 7, fig. 3; Frey, 1856: 379; 1857: 397, 398; Stainton, 1849: 433; Wocke, 1871: 339; 1874: 102; Heinemann & Wocke, 1877: 767; Snellen, 1882: 1002—3; Sorhagen, 1886: 310, 311; Meyrick, 1895: 725, 726; Tutt, 1899: 352; Rebel, 1901: 228; Meess, 1910: 481; Sorhagen, 1922: 56, 57 (partim); Meyrick, 1928: 863; Waters, 1928: 248—251 (differences with *albifasciella*); Petersen, 1930: 77, fig. 121 (♂ genitalia); Szöcs, 1965: 86.

*Stigmella subbimaculella*; Klimesch, 1951: 65; Gerasimov, 1952: 262; Klimesch, 1961: 761; Lhomme, 1963: 1204; Borkowski, 1969: 111.

*Dectivria subbimaculella*; Beirne, 1945: 205, fig. 64 (♂ genitalia); Emmet, 1971: 247, 248.

*Stigmella (Dectivria) subbimaculella*; Hering, 1957: 866, fig. 533 (mine).

*Trifurcula (Ectoedemia) subbimaculella*; Johansson, 1971: 245.

*Ectoedemia subbimaculella*; Bradley et al., 1972: 3; Borkowski, 1975: 490; Emmet, 1976: 200, fig. 60a, b, pl. 7, fig. 3, pl. 12, fig. 32.

*Trifurcula subbimaculella*; Karsholt & Nielsen, 1976: 18.

[no genus] *cursoriella*; Herrich-Schäffer, [1853]: pl. 106, fig. 844.

*Nepticula cursoriella*; Herrich-Schäffer, 1855: 356.

Diagnosis: from most other *Ectoedemia* species distinguished by the white basal spot on the forewing and absence of hair-pencil in male. Very difficult to separate from other species in the complex, which have usually a darker head and are slightly smaller. The differences in the male genitalia are not diagnostic. The female can be separated by the wider convolutions in the ductus spermathecae. *E. subbimaculella* is most easily identified by the dark larval head and prothorax and the slit in the mine.

#### Description.

Male. Forewing length 2.24—2.8 mm (2.50 ± 0.15, 26), wingspan 4.8—6.1 mm. Head: frontal tuft yellowish orange, sometimes with fuscous scales on vertex; collar dark brown. Antennae with 31—36 segments (33.3 ± 1.3, 21). Thorax black, with some white scales at tips of mesoscutum and tegulae. Forewing blackish fuscous with a white basal spot along dorsal margin, a dorsal spot in middle and a costal spot before middle, sometimes uniting to form a fascia. Hindwing without hair-pencil, but with costal bristles.

Female (fig. 71). Forewing length 2.16—2.8 mm (2.52 ± 0.19, 25). Antennae with 24—29 segments (25.7 ± 1.1, 24).

Male genitalia (figs. 121, 265, 313, 384). Capsule length 231—304 μm (274.1 ± 19.2, 24). Tegumen produced into rounded pseuduncus. Gnathos (fig. 313) with central element gradually narrowing to rounded tip. Valva (fig. 265) length 193—244 μm (222.7 ± 13.8, 25), apically gradually narrowed into blunt tip; inner margin little convex to concave, serrate by prominent sockets of many setae on inner and dorsal surfaces. Aedeagus (fig. 384) 210—261 μm (243.5 ± 14.3, 23), carinae with variable number of spines.

Female genitalia (figs. 199, 200, 417, 455). T7 with a row of 6—10 setae along anterior margin of T8; T8 with two lateral groups of scales and 3—7 setae each; S8 with converging margins. Anal papillae with 9—16 setae. Vestibulum with



vaginal sclerite, a dorsal spiculate pouch, and a group of densely packed pectinations near entrance of ductus spermathecae. Corpus bursae 450—710  $\mu\text{m}$ , without pectinations; signa dissimilar, longest 390—514 ( $459.0 \pm 34.3$ , 11), shortest 339—467  $\mu\text{m}$  ( $408.3 \pm 38.4$ , 11),  $4.4\text{--}5.6 \times$  as long as wide. Ductus spermathecae with  $2\frac{1}{4}\text{--}2\frac{1}{2}$  (rarely 3) convolutions, wider than in *beringi*, narrower than in *albifasciella* (fig. 417).

Larva. Translucent glossy white, with dark brown or black head-capsule and prothoracic plate. Ganglia more or less conspicuous. Ventral plates absent.

#### Biology.

Host plants: *Quercus robur* L., *Q. petraea* (Mattuschka) Liebl., *Q. pyrenaica* Willd. and *Q. pubescens* Willd., a few mines known from *Q. cerris* L. in Yugoslavia. Rarely on *Q. rubra* L. In botanical gardens on a wide variety of deciduous oaks.

Mine (fig. 494). Egg on upperside of leaf, beside vein. Mine: narrow linear gallery along vein, abruptly changing in blotch, usually in angle between midrib and lateral vein. The larva makes a slit in the under epidermis, through which water and frass fall out of the mine. In Austrian mines on *Q. pubescens* the slit was often in the upper epidermis or in both surfaces. When the egg is laid along a lateral vein, the larva usually feeds towards the midrib.

Life history. Univoltine, larvae from late September until November, adults flying in June and July.

#### Distribution (fig. 523).

Widely distributed in West and Central Europe, and in Scandinavia only in southern Sweden and Denmark, most northern records being misidentifications (R. Johansson, pers. comm.); it is not recorded from Ireland and Scotland. In the south the distribution is insufficiently known, confirmed records are available from northern Italy, Sicily, Hungary, Yugoslavia and southwest USSR.

#### Remarks.

The lectotype is a male in good condition which was placed in the Stainton collection with a "Type" label. On examining the lectotype of *nigrociliella* Stephens, also from Stainton's collection, the synonymy was confirmed, which was already suggested by several authors (Stainton, 1855; Bradley et al., 1972). Types of *curso-*

*riella* Zeller could not be found, but it is likely to be a synonym of *subbimaculella*, and has always been treated as such since Herrich-Schäffer (1855).

Until the beginning of this century, this was the only oak-mining species of this group recognised by most authors, even *albifasciella* was generally considered a variety. Waters (1928) was the first to recognise the differences in biology between *subbimaculella* and *albifasciella*. Therefore all older literature records are useless, unless a clear description of the characteristic mine with slit is given. More recent records of adults which have not been reared have to be checked since they are easily confused. Hering (1957) mentioned a probable new species from Sicily on *Q. pubescens*, with similar mines, but with larvae making cocoons in their mines. In BMNH there are such mines, but in all cocoons which are still in these mines, pupae of parasitic Hymenoptera can be observed. The phenomenon of parasitised larvae, spinning their cocoons inside the mine has been noted in several species, thus these are probably *subbimaculella* mines. This is further corroborated by *subbimaculella* adults in the Groschke collection, which probably come from Taormina (see also *caradjai*).

Material examined: 116  $\sigma$ , 122  $\varphi$ , 3 ex. — Austria: 11  $\sigma$ , 14  $\varphi$ , Hainburg; Hundsheimer Berg, 200—400 m, e.l. 8—21.vi.1984, *Quercus pubescens*, E. J. van Nieukerken (ZMA); 1  $\sigma$ , Hundsheimer Berg (near Hainburg), 28.vi.1976, F. Kasy; 1  $\sigma$ , Klosterneuburg, Buchberg, e.l. 14.v.1942, *Q. robur*, Preisseecker (NMW); 6  $\sigma$ , 5  $\varphi$ , Loretto, 7 km N. Eisenstadt (Burgenland), 240 m, e.l. 30.iv—14.v.1984, *Quercus pubescens*, E. J. van Nieukerken; 1  $\sigma$ , Wien, Leopoldsb., W. of Kahlenberg, 200—400 m, e.l. 2.v.1984, *Quercus pubescens*, E. J. van Nieukerken (ZMA). — France: 1  $\sigma$ , Pessac-Alouette (Gironde), 3.vi.1934, Le Marchand; 1  $\sigma$ , Mutrécy (Calvados), S. of Caen, 15.vi.1919, Le Marchand (MNHN); 1  $\varphi$ , Mulhouse, Bois de Nonnenbruch, 250 m, 12.vi.1977, S. E. Whitebread (coll. Whitebread); 2  $\sigma$ , 1  $\varphi$ , Ozoir la Ferrière, 30.v.1946, Le Marchand; 1  $\sigma$ , Vaucresson (Hauts de Seine), 17.vi.1946, Le Marchand (MNHN); 1  $\sigma$ , Pontault, 28.iv.1977, P. Leraut (coll. Leraut). — Germany, East: 7  $\sigma$ , 11  $\varphi$ , Berlin, Finkenkrug, e.l. 25—31.v.1930, *Q. robur*, Hering (MHUB); 2  $\varphi$ , Nordhausen, 27.v.1898, Krone (TMAB); 6  $\sigma$ , 6  $\varphi$ , Potsdam, e.l. 2—18.v.1900, Hinneberg (MHUB). — Great Britain: 2  $\sigma$  (lectotypes *subbimaculella* and *nigrociliella*, see above); 3  $\sigma$ , 1  $\varphi$ , Southampton, 15.vi.1935, Fassnidge; 1  $\varphi$ , Weeley (Essex), Maldon Wood, e.l. 11.vi.1980, Bryan, Emmet & Van Nieukerken (ZMA). — Hungary: 1  $\varphi$ , Budapest, Hivós, e.l. 24.v.1956, J. Szócs (TMAB). — Italy: 3  $\sigma$ , 1  $\varphi$ , [Sici-



lia, Taormina), 554, Groschke (SMNS). — Netherlands: 65 ♂, 73 ♀, from following localities: Aerdenhout, Amerongen, Arnhem, Bergen (N.H.), Berghem, Breda, Bussum, Doetinchem, Echt, Geulhem, Groesbeek, Den Haag, Helvoirt, Herkenbosch, Hilversum, Hollandse Rading, Horst, Hulshorst, De Lutte, Maarn, Naardermeer, Nunspeet, Olterterp, Oosterbeek, Overberg, Overveen, Rijs, Rotterdam, Santpoort, Ubbergen, Wageningen, Wassenaar, Winterswijk, Zandvoort, Zwanewater (RMNH, ZMA, AFW, coll. Huisman, coll. Koster, coll. Kuchlein). — Poland: 1 ♂, Dąbie (Alt Damm), e.l. 4.vi. Krone (TMAB). — Portugal: 3 ♂, 3 ♀, [San Fiel, Beira Baixa], 9.v. *Quercus toza* (= *Q. pyrenaica*), [Mendes], coll. De Joannis (MNNH). — Yugoslavia: 1 ♀, Bački Monoštor, 4 km S. Bezdan (Vojvodina), e.l. 5—7.v.1984, *Quercus petraea*, J. J. Boomsma & E. J. van Nieukerken; 1 ♂, Križišće, 10 km NNW Crikvenica (Hrvatska), e.l. 10.v.1984, *Quercus pubescens*, J. J. Boomsma & E. J. van Nieukerken (ZMA).

Mines. — On *Quercus cerris*. — Yugoslavia: NE Bihac. On *Quercus petraea*. — Hungary: Törökbálint. — Yugoslavia: NE Bihac; Bački Monoštor, near Bezdan. On *Quercus pubescens*. — Austria: Gumpoldskirchen; Hundsheimer Berg near Hainburg; Loretto; Wien, Leopoldsborg. — Italy: Picinisco; Sicilia, Taormina, leg. Groschke (BMNH). — Yugoslavia: NNW Crikvenica. On *Quercus robur*. — Austria: Hof am Leithagebirge. — Belgium: Zolder. — Great Britain: Danbury; Earls Colne; Rainham; Tiptree, Weeley. — Netherlands: many localities.

#### 34. *Ectoedemia (Ectoedemia) heringi* (Toll, 1934)

(figs. 72, 122, 123, 203, 266, 314, 315, 385, 418, 456, 495, 524)

*Nepticula heringi* Toll, 1934a: 1, figs. 3, 4. Lectotype ♂ (here designated), Poland: Bydgoszcz, Rynkowo, e.l. 5.iii.1934, *Quercus pendunculata*, Toll, Genitalia slide VU 1408 (IPK) [examined].

*Nepticula quercifoliae* Toll, 1934b: 71, 81, pl. 2. Lectotype ♀ (here designated), Poland, Bydgoszcz, Rynkowo, e.l. 18.iii.1935, *Quercus robur*, Toll, Genitalia slide VU 1409 (IPK) [examined] [synonymised by Borkowski, 1975].

*Nepticula sativella* Klimesch, 1936: 208, figs. 10—13. Lectotype ♀ (here designated), Italy: Teriolis merid., Naturno near Merano, e.l. 15—19.v.1935, *Castanea sativa*, J. Klimesch, Genitalia slide VU 1391 (ZSMK) [examined], **Syn. nov.**

*Nepticula zimmermanni* Hering, 1942: 26, fig. Lectotype ♀ (here designated), Czechoslovakia, Libochowan (near Litomerice), Elbe, vi.1940, *Quercus lanuginosa*, F. Zimmermann, Genitalia slide VU 0896 (MHUB) [examined], **Syn. nov.**

*Nepticula heringi*; Toll, 1934b: 71; Szöcs, 1965: 86.

*Stigmella (Dechthiria) heringi*; Hering, 1957: 867 (mine).

*Stigmella heringi*; Klimesch, 1961: 761; Borkowski, 1969: 110.

*Ectoedemia heringi*; Borkowski, 1975: 491; Emmet, 1979: 16.

*Trifurcula (Ectoedemia) heringi*; Kasy, 1978: 4; Leraut, 1980: 49.

*Nepticula quercifoliae*; Klimesch, 1936: 190; Szöcs, 1965: 87.

*Stigmella (Dechthiria) quercifoliae*; Hering, 1957: 867 (mine).

*Stigmella quercifoliae*; Klimesch, 1961: 761; Borkowski, 1969: 110.

*Ectoedemia quercifoliae*; Bradley et al., 1972: 3; Emmet, 1974a: 108, 147, 148; 1976: 200, fig. 60c, d, pl. 12 fig. 31, pl. 6 fig. 11; Leraut, 1977: 91.

*Stigmella sativella*; Klimesch, 1948: 74—76, fig. 55—57; Klimesch, 1951: 65.

*Stigmella (Dechthiria) sativella*; Hering, 1957: 256, fig. 165 (mine).

*Stigmella zimmermanni*; Klimesch, 1951: 65; 1961: 761.

*Stigmella (Dechthiria) zimmermanni*; Hering, 1957: 866, fig. 540 (mine).

*Nepticula zimmermanni*; Szöcs, 1965: 86.

*Trifurcula (Ectoedemia) zimmermanni*; Kasy, 1978: 4.

*Ectoedemia zimmermanni*; Szöcs, 1981: 210.

Diagnosis: distinguished from *E. subbimaculella* by the darker head and the ductus spermathecae in the female; the species is slightly smaller than *subbimaculella*. Adults not separable from *phyllostomella* or *liechtensteini*. In the mine there is no slit, which makes it very similar to the mine of *E. albifasciella*, however, *heringi* usually feeds towards the midrib.

#### Description.

Male (fig. 72). Forewing length 1.88—2.4 mm ( $2.18 \pm 0.18$ , 14), wingspan 4.2—5.3 mm. Head: frontal tuft ferruginous, on vertex brown to black, a sharp delimitation of the light and dark area at the level of antennal insertion; collar similar to vertex. Antennae with 29—32 (—36) segments ( $31 \pm 2.0$ , 13). Thorax and forewing as in *E. subbimaculella*, but basal spot often larger. Hindwing with costal bristles.

Female. Forewing length 1.88—2.44 mm ( $2.14 \pm 0.18$ , 8). Antennae with 22—25 segments ( $23.4 \pm 1.3$ , 7).

Male genitalia (figs. 121, 123, 266, 314, 315, 385). Capsule 230—270  $\mu\text{m}$  ( $249.6 \pm 14.6$ , 12). Tegumen broadly rounded, slightly less producing than in *subbimaculella*. Gnathos (figs. 314, 315) with rather short and broad, rounded central element. Valva (fig. 266) length 175—215  $\mu\text{m}$  ( $195.4 \pm 10.2$ , 12), tip blunt, broader than in *subbimaculella*, inner margin straight, or hardly convex in proximal third, concave apically. Ae-

deagus (fig. 385) 205—255  $\mu\text{m}$  ( $228.6 \pm 14.3$ , 12). Several specimens are not separable from *subbimaculella*.

Female genitalia (figs. 203, 418, 456). T7 with a row of 6—10 setae along posterior margin. T8 with two lateral groups of scales and 1—3 setae. Anal papillae with 9—15 setae. Corpus bursae 410—660  $\mu\text{m}$ ; longest signum 347—463  $\mu\text{m}$  ( $395.5 \pm 35.9$ , 11), shortest 309—420  $\mu\text{m}$  ( $350.1 \pm 33.6$ , 10), 4.4—5.8  $\times$  as long as wide. One specimen with much smaller signa: 257, 287  $\mu\text{m}$ . Ductus spermathecae with 2—2¼ narrow convolutions (fig. 418).

Larva. Translucent yellowish white, or greenish white, with dark brown head-capsule. Ganglia usually conspicuous, but sometimes less so. Ventral plates absent. Separated from *albifasciella* by darker head.

#### Biology.

Host plants: *Quercus robur* L., *Q. petraea* (Mattuschka) Liebl., *Q. pubescens* Willd., *Q. faginea* Lam. and *Castanea sativa* Miller.

Mine (fig. 495). Egg on the upperside beside a vein, often the midrib. Mine starts as narrow linear gallery following vein, usually towards midrib, abruptly changing into a blotch, or false blotch, without slit, usually in angle between midrib and lateral vein. Sometimes the last part resembles more a wide gallery than a blotch.

Life history. Univoltine, larvae from late September until November, but in southern Spain also found in February, adults flying in May in the south and in June and July more in the north.

#### Distribution (fig. 524).

Due to confusion with *subbimaculella* and *albifasciella* insufficiently known. Apparently lacking in Scandinavia and the Netherlands, scarce in south east England, more common in central Europe.

#### Remarks.

This species seems to have the widest range of foodplant species within the *subbimaculella* group. Some of the synonyms listed here were described as separate species only on the basis of a different foodplant species. These forms, *E. zimmermanni* on *Q. pubescens* and *E. sativella* on *Castanea sativa*, of which lectotypes have been selected, differ neither morphologically, nor biologically and can therefore only be treated as one species. *E. heringi* and *quercifoliae* were both described in 1934, but which was

published first is not clear, however, most likely *heringi* should take priority, since it is also mentioned in Toll (1934b), as an established species. In this paper Toll compares the larval characters and the mines of both species. *N. quercifoliae* was originally only described from mines and larvae which were collected in the autumn of 1934. From these, in fact the syntypes, he reared adults in 1935, which can therefore be regarded as type material. The  $\delta$  in Toll's collection, bearing the label "type", is selected as lectotype.

Material examined: 72  $\delta$ , 76  $\eta$ : reared from *Quercus robur* or *petraea*: 33  $\delta$ , 25  $\eta$ . — Austria: 2  $\delta$ , Klosterneuburg, Freiberg, e.l. 9.v.1932, 18.iv.1938, Preissecker; 1  $\eta$ , Klosterneuburg, Buchberg, e.l. 25.v.1941, Preissecker (NMW). — France: 3  $\delta$ , 1  $\eta$ : Andlau (Bas-Rhin), Kastelberg, e.l. 9—19.vi.1979, *Q. petraea*, E. J. van Nieukerken (ZMA). — Hungary: 1  $\eta$ , Szentpéterföldre, e.l. 25.v.1969, *Q. robur*, J. Szöcs (TMAB). — Poland: 3  $\delta$  (lecto- and paralectotypes of *heringi*), Bydgoszcz, Rynkowo, e.l. 28.ii—7.iii.1934, *Q. pedunculata*, Toll (ZMC, MHUB); 2  $\delta$ , 1  $\eta$  (lecto- and paralectotypes of *quercifoliae*), same locality, e.l. 16—18.iii.1935, *Q. robur*, *petraea*, Toll (IPAK); 21  $\delta$ , 21  $\eta$ , idem, e.l. iii.1936, *Q. petraea*, Toll (IPAK, MHUB, MNHN). — Yugoslavia: 2  $\delta$ , S. of Han Knežica, 11 km N. of Prijedor (Bosna), e.l. 25.iv—1.v.1984, *Quercus robur*, J. J. Boomsma & E. J. van Nieukerken (ZMA).

Reared from *Q. pubescens*: 23  $\delta$ , 35  $\eta$ . — Austria: 3  $\delta$ , 7  $\eta$ , Hainburg, Hundsheimer Berg, 200—400 m, e.l. 27.iv.—1.v.1984, E. J. van Nieukerken; 3  $\delta$ , 8  $\eta$ , Wien, Leopoldsberg, W. of Kahlenberg, 200—400 m, e.l. 6—12.vi.1984 (ZMA). — Czechoslovakia: 14  $\delta$ , 16  $\eta$  (lecto- and paralectotypes of *zimmermanni*), Libochowan (near Litomerice), Elbe, e.l. vi.1940, Zimmermann (MHUB, ZMC). — Hungary: 1  $\delta$ , 1  $\eta$ , Pécs Mecsek, Misina, e.l. 27—29.iv.1966, J. Szöcs; 2  $\delta$ , 3  $\eta$ , Törökbálint (W. of Budapest), e.l. 12—17.v.1974, J. Szöcs (TMAB).

Reared from *Quercus faginea*: 1  $\eta$ , Spain: 3 km NW. San Pedro de Alcántara (Málaga), 300 m, mine 6.ii.1984, e.l. 25—26.iv.1984, E. J. van Nieukerken (ZMA).

Reared from *Castanea sativa*: 2  $\delta$ , 2  $\eta$ . — Italy: 2  $\delta$ , 1  $\eta$  (lecto- and paralectotypes of *sativella*), Naturno, near Merano, e.l. 15—24.v.1935, Klimesch (ZSMK); 1  $\eta$ , Trento, e.l. v.1946, J. Klimesch (MNHN).

Reared from unknown *Quercus* or not reared, but likely to be *heringi*: 14  $\delta$ , 13  $\eta$ . — Austria: 3  $\delta$ , 6  $\eta$ , Hackelsberg, N. of Neusiedlersee, 1971—1977, F. Kasy; 1  $\eta$ , Hundsheimer Berg (near Hainburg), 28.vi.1976, F. Kasy (NMW). — France: 2  $\delta$ , no data, De Joannis (MNHN). — Germany, West: 1  $\delta$ , 1  $\eta$ , Stuttgart, Lindental, e.l. 27.iv—4.v.1947, Wörrz; 1  $\delta$ , 1  $\eta$ , Stuttgart, Wildpark, e.l. 9.v.1938, Wörrz (LNK); 1  $\eta$ , Wolfenbuttel, [Heinemann], coll. Staudinger (MHUB). — Germany, East: 1  $\delta$ , Altenburg, 1874,



Krause; 1 ♂, Dresden, Staudinger (MHUB). — Hungary: 1 ♂, Budapest, Zanoshegg, e.l. 15.v.1960, J. Szöcs; 1 ♂, Szigetszentmiklós, e.l. 23.v.1955, J. Szöcs (TMAB). — Poland: 3 ♂, 3 ♀, Wrocław (Breslau), e.l. iv.1869, Wocke (MHUB).

Identity uncertain: 1 ♂, 1 ♀. — Albania: 1 ♂, Kula Ljums, 7—14.vi.1918, Alban. Exped. — Yugoslavia: 1 ♀, Drenovo near Kavadarci, 20—30.v.1957, Kasy (NMW).

Mines. — On *Quercus faginea*. — Spain: Istan; NW of San Pedro de Alcántara. On *Quercus petraea*. — France: Andlau. — Hungary: Törökbalint. — Poland: Bydgoszcz, leg. Toll (BMNH). — Yugoslavia: 11 km NE Bihac; Slavonska Požega. On *Quercus pubescens*. — Austria: Gumpoldskirchen; Hundsheimer Berg; Loretto; Wien, Leopoldsb. — Czechoslovakia: Libochowán, near Litomerice, leg. Zimmermann (BMNH). — Hungary: Budaörs. On *Quercus robur*. — Great Britain: S. of Weeley. — Poland: Bydgoszcz, leg. Toll (BMNH). — Yugoslavia: Han Knežica, N. of Prijedor.

### 35. *Ectoedemia* (*Ectoedemia*) *liechtensteini*

(Zimmermann, 1944)

(figs. 124, 204, 496, 525)

*Nepticula liechtensteini* Zimmermann, 1944: 119—121, fig. 8. Lectotype ♀ (here designated), Czechoslovakia: Moravia merid., Lednice (Eisgrub), F. Zimmermann, Genitalia slide 4775 (MHUB) [examined].

*Stigmella* (*Dechtria*) *liechtensteini*; Hering, 1957: 866, fig. 558 (mine).

*Ectoedemia liechtensteini*; Szöcs, 1978: 266.

Diagnosis: adults cannot be separated from *heringi*. Larvae intensely amber-yellow, without visible ganglia in contrast with greenish white larvae of *heringi*, which usually have distinct ganglia. Specific status doubtful.

#### Description.

Male. Forewing length 2.12—2.16 (3), wingspan 4.8 mm. Antennae with 28—31 segments. Further as *heringi*.

Female. Forewing length 1.8—2.28 (3), wingspan 4.4—5.2 mm. Antennae with 22—24 segments.

Male genitalia (fig. 124). Similar to *heringi*. Capsule length 249 µm (2). Valva length 180—210 µm (2). Aedeagus 223—231 µm (3).

Female genitalia (fig. 204). T7 with a row of 6—8 setae. T8 with 3—5 setae at each side. Anal papillae with 10—12 setae. Corpus bursae 460—595 µm; longest signum 334—411 µm (2); shortest 291—356 µm (2), 4.5—4.9 × as long as wide. Ductus spermathecae with 2—2 ¼ inconspicuous convolutions.

Larva. Intensely, glossy amber yellow, with

very light brown head-capsule and prothoracic plate. Not the slightest indication of ganglia. Ventral plates absent.

#### Biology.

Hostplants. *Quercus cerris* L. on which it can be very abundant. Very occasionally on *Q. petraea* (Mattuschka) Liebl. or *Q. pubescens* Willd. (see remarks).

Mine (fig. 496). Egg on leaf upperside. Mine completely similar to *heringi*, in the axil of the midrib and a lateral vein.

Life history. Univoltine. Larvae in October–November, usually much later than *E. cerris*, especially abundant in late October. Adults (reared) from April to June.

#### Distribution (fig. 525).

With certainty from Moravia, east Austria, Hungary and Yugoslavia.

#### Remarks.

The separate identity of this species is uncertain. Adults are similar to *heringi*, but the larvae are very different, and can easily be distinguished. Moreover, larvae of *liechtensteini* are usually found on *Q. cerris*, whereas sympatric *heringi* occurs on other oak species, but never on *cerris*. However, in autumn 1983 I also found one larva of the *liechtensteini* type on *Q. petraea*, in a locality with numerous *liechtensteini* on *Q. cerris*, and several larvae on *Q. pubescens* in Gumpoldskirchen. In the latter locality no *Q. cerris* grew, but on the *Q. pubescens* some “normal” *heringi* larvae were also noted. S. Menken (pers. comm.) could find no difference in their allozymes and allozyme differences with *heringi* were insignificant. It will be necessary to set up foodplant choice and hybridisation experiments in order to solve problems of isolation in this species complex.

The striking differences in the larva lead me to consider *liechtensteini* tentatively as a separate taxon, having no evidence to the contrary.

Material examined, 22 ♂, 22 ♀. — Austria: 7 ♂, 9 ♀, Hof am Leithagebirge, S. of Mannersdorf (Niederöst.), 200 m, e.l. 2.v, 10—18.vi.1984, *Quercus cerris*, E. J. van Nieukerken; 3 ♂, 3 ♀, Loretto, 7 km N. Eisenstadt (Burgenland), 240 m, e.l. 5—25.v.1984, *Quercus cerris*, E. J. van Nieukerken; 1 ♂, Wien, Kahlenberg SE., 400 m, e.l. 30.iv—1.v.1984, *Quercus cerris*, E. J. van Nieukerken (ZMA). — Czechoslovakia, 5 ♂, 3 ♀ (lecto- and paralectotypes), Moravia merid., Lednice (Eisgrub), Zimmermann (MHUB, ZMC). — Hungary: 2 ♂, 2 ♀, Törökbalint (W. of Bu-



dapest), e.l. 5, 11.v.1968, 14, 18.v.1974, *Q. cerris*, J. Szöcs (TMAB); 2 ♂, Törökbálint, Nagy-erdő, 5 km N. Érd, e.l. 25.iv—1.v.1984, *Quercus cerris*, J. J. Boomsma & E. J. van Nieuwerkerken (ZMA). — Yugoslavia: 2 ♂, 4 ♀, Bački Monoštor, 4 km S. Beždan (Vojvodina), e.l. 25.iv—4.v.1984, *Quercus cerris*, J. J. Boomsma & E. J. van Nieuwerkerken (ZMA).

Mines. On *Quercus cerris*. — Austria: Eisenstadt; Hof am Leithagebirge; Loretto. — Czechoslovakia: Lednice (Eisgrub), leg. Zimmerman (BMNH). — Hungary: Törökbálint. — Yugoslavia: Han Knežica, N. of Prijedor; Bački Monoštor, S. of Beždan. On *Quercus petraea*. — Hungary: Törökbálint (1 mine). On *Quercus pubescens*. — Austria: Gumpoldskirchen.

### 36. *Ectoedemia (Ectoedemia) phyllotomella* (Klimesch, 1946) comb. n.

(figs. 73, 125, 205, 267, 386, 457, 497, 525)

*Stigmella phyllotomella* Klimesch, 1946: 166, fig. 7, pl. 12. Lectotype ♂ (here designated), Italy: Liguria, Altare near Ferrania, e.l. 26.iv—7.v.1945, *Quercus cerris*, 2.xi.1944, Zucht 507, J. Klimesch, Genitalia slide Kl. 270 (ZSMK) [examined].

*Stigmella phyllotomella*; Hering, 1957: 855 (mine).

Diagnosis: adults not separable from *heringi*, although head slightly lighter. Female separated from *subbimaculella* by narrower convolutions of ductus spermathecae. Mines very characteristic by circular "cut-out".

#### Description.

Male (fig. 73). Forewing length 2.16—2.24 mm, wingspan 4.9—5.2 mm. Antennae with 30—34 segments. Head: frontal tuft yellowish orange, on vertex fuscous. Further as *subbimaculella*.

Female. Forewing length 2.04 mm, wingspan 4.6 mm. Antennae with 23 segments.

Male genitalia (figs. 125, 267, 386). Similar to *subbimaculella*. Capsule length 233—253 μm (3). Valva (fig. 267) length 193—210 μm (3). Aedeagus (fig. 386) 214—236 μm (2).

Female genitalia (figs. 205, 457). T7 with a row of 8 setae. T8 with 2—5 setae at each side. Anal papillae with 8—9 setae. Corpus bursae 515—530 μm; longest signum 386—390 μm, shortest 339—356 μm, 4.6—4.9 × as long as wide. Ductus spermathecae with 2 very inconspicuous convolutions.

Larva not examined.

#### Biology.

Hostplant: *Quercus cerris* L.

Mine (fig. 497). Egg on leaf upperside, against midrib. Early gallery narrow, following vein or

midrib; later becoming highly contorted gallery with linear frass, often forming false blotch. The larva cuts out an oval case from the end of the mine, in which it pupates. The case does not fall immediately to the ground, but after some time, by weathering of the leaf.

Life history. Univoltine. Larvae collected in late October and early November, adults reared in April and May.

Distribution (fig. 525).

Only known from Italy: Liguria and Lucania.

#### Remarks.

The peculiar habit of the larva, and the food-plant, suggest that *phyllotomella* is a separate entity, isolated from the other species of the complex. Study of larvae and electrophoresis of allozymes might shed some light on the degree of genetic isolation from its relatives.

Material examined: 3 ♂, 2 ♀. — Italy: 2 ♂, 1 ♀ (lecto- and paralectotypes), Liguria, Altare near Ferrania, e.l. 26.iv—7.v.1945, J. Klimesch (ZSMK); 1 ♂, 1 ♀, Lucania, Mte Vulture, Laghi di Monticchio, 750 m, e.l. 2—7.iv.1966, F. Hartig (LNK).

Mines. — Italy: Ferrania, Ligur. Appenin, leg. Klimesch (BMNH) (2 mines only).

### 37. *Ectoedemia (Ectoedemia) spec.* (specimen 1375) (figs. 74, 206, 458)

Material: 1 ♀, Iran: 100 km W. Shiraz, 18.iv.1970, Exp. Mus. Vind., Genitalia slide VU 1375 (NMW).

Undoubtedly a new species, which I do not name here, because of limited material and lack of knowledge on biology. It is externally most similar to *gilvipennella*.

#### Description.

Male unknown.

Female (fig. 74). Forewing length 2.4 mm, wingspan 5.3 mm. Head: frontal tuft ochreous-white; collar white. Antenna with 23 segments. Thorax and forewings uniform light brown irrorate with yellowish white.

Female genitalia (figs. 206, 458). T7 with a distinct row of 14 setae along posterior margin. T8 with two groups of few (3—5) setae, no scales. Anal papillae with 17—18 setae. Vestibulum with vaginal sclerite, a spiculate pouch with many spines and a dense patch of pectinations near entrance of ductus spermathecae. Corpus bursae 595 μm, without pectinations; signa dissimilar, longest 437 μm, shortest 360 μm, 3.9 × as long as wide. Ductus spermathecae with 3 narrow convolutions.

The *Ectoedemia terebinthivora* group38. *Ectoedemia (Ectoedemia) terebinthivora*  
(Klimesch, 1975) comb. n.

(figs. 75, 126, 201, 202, 268, 316, 383, 412, 459, 498, 540)

*Trifurcula (Ectoedemia) terebinthivora* Klimesch, 1975b: 19—23, figs. 27—33. Syntypes, 4 ♂, 8 ♀, Anatolia: Kanlidivane, along road Silifke-Mersin, larvae 31.v.1970, e.l. 24—30. vi.1970, Klimesch (ZSMK) [not examined].*Trifurcula (Ectoedemia) terebinthivora*; Klimesch, 1978: 251, figs. 26—28 (mine, ♂, ♀ genitalia).

Diagnosis: externally characterised by small size, light brown ground-colour with yellowish tinge and in male by hindwing almost completely covered with brown androconial scales. *E. aegilopidella* has similar scales in male but has also a hair-pencil which is absent in *terebinthivora*.

## Description.

Male. Forewing length 1.88—2.24 mm (2.08 ± 0.12, 8), wingspan 4.1—5.0 mm. Head: frontal tuft very variable, from completely yellowish to dark brown, variation not sex-linked; collar similar or slightly lighter. Antennae with 39—41 segments (40.3 ± 1.0, 7). Thorax and forewings brown, with an obvious yellow tinge; thorax sometimes apically lighter; forewing with a medial yellowish fascia, somewhat irregular, outer margin concave, sometimes fascia indistinct. Hindwing covered in basal two thirds with brown lamellar androconial scales, not extending in fringe; costal bristles or hair-pencil absent. Underside forewing with few similar brown scales near base.

Female (fig. 75). Forewing length 2.12—2.32 mm (2.23 ± 0.09, 8), wingspan 4.7—5.2 mm. Antennae with 33—35 segments (34.1 ± 0.7, 7).

Male genitalia (figs. 126, 268, 316, 383, 412). Capsule length 197—214 µm (4). Tegumen produced into broad, truncate pseuduncus (fig. 412). Gnathos (fig. 316) with very short, rounded central element. Valva (fig. 268) length 146—163 µm (4), inner margin almost straight, except basally, tip pointed. Aedeagus (fig. 383) 279—300 µm (4), much longer than capsule, with pair of single, pointed, dorsal carinae.

Female genitalia (figs. 201, 202, 459). T7 without row of setae. T8 with two lateral patches of scales and setae (6—7). Anal papillae with 8—10 setae. Anterior apophyses remarkably widened in middle. Vestibulum with vaginal sclerite and dorsal spiculate pouch with

many pointed spines, and a dense patch of pectinations near entrance of ductus spermathecae. Corpus bursae 470—530 µm, covered with minute pectinations, except anteriormost part; signa dissimilar, longest 369—403 µm (4), shortest 309—334 µm (4), 4.2—5.0 × as long as wide. Ductus spermathecae with 2—2 ½ convolutions.

Larva. Yellowish white to whitish, in mine appearing greenish, first 4 ganglia distinct. Head-capsule brown. Penultimate stages with 12 ventral brown plates.

## Biology.

Hostplant. *Pistacia terebinthus* L.

Mine (fig. 498). Egg always deposited on leaf underside, close to midrib or lateral vein. Early mine much contorted with thin brownish linear or dispersed frass; later widening into large irregular, elongate blotch with dispersed brown frass.

Life history. Probably bivoltine, or at least partly. Larvae in late May and June (Klimesch, 1975b) and in September. Adults reared in June and July (from May and June larvae) and May—June (from September larvae). Therefore Klimesch's assumption that the species is univoltine seems to be incorrect.

## Distribution (fig. 540).

Greece, Ionian and Aegean Islands and Anatolia. Probably widespread in eastern Mediterranean. Record from Keffalinia from mines in old herbarium specimen of *Pistacia* in Rijksherbarium, Leiden, no. 897, 363—722.

Material examined: 12 ♂, 12 ♀. — Greece: 1 ♀, Athina (Atena), 16.vi.1980, Leo Kohonen (ZMUO); 11 ♂, 9 ♀, 3 km E. of Dhelfoi (Fokis), 700 m, e.l. 2.v—11.vi.1981, *Pistacia terebinthus*, 27.ix.1980, S. B. J. Menken, E. J. van Nieukerken (ZMA, BMNH, ZSMK); 1 ♂, 1 ♀, Kardhamili (Messinia), a.s.l., e.l. 14—16.vii.1984, E. J. van Nieukerken (ZMA). — Turkey: 1 ♀, Asia minor, Tekir Tepisi, Taurus, 13.viii.1965, Arenberger (LNK).

Mines. — Greece: Parnis Oros (Attika); Evvoia: SE Gouvés; Oíti Oros, SW Ipáti (Fthiótis); Dhelfoi (Fókis); Kardhamili (Messinia).

The *Ectoedemia angulifasciella* group

This is a rather heterogenous assemblage of Rosaceae mining species, comprising a tight group — *hexapetalae*, *angulifasciella* complex, *mabalebella* and *spinoseella* — and some aberrant species which at present cannot be included in any other group.

The adults usually have a shining metallic fascia, and males have a hair-pencil, or this is secondarily lost.

Except in the first three species, the gnathos is divided, and the basal part has a serrate margin. The aedeagus has one pair of carinae, often with additional spines. The valva is comparatively uniform, with a more or less straight inner margin.

In female genitalia the vaginal sclerite is present in most species except *spiraeae* and *agrimoniae*, but the spiculate pouch is less distinct than in previous groups or even absent. The bursa is covered with pectinations.

The larvae make gallery-blotch mines, and only the species in the *angulifasciella* complex have ventral plates in the penultimate stages.

Species belonging to this group occur also in Japan and probably in North America (*E. rubifoliella* (Clemens)).

### 39. *Ectoedemia* (*Ectoedemia*) *erythrogenella* (de Joannis, 1908)

(figs. 76, 128, 129, 207, 269, 317, 387, 460, 499, 528)

*Nepticula erythrogenella* J. de Joannis, 1908a: 327, 328. Lectotype ♂ (here designated), France: Vannes, L. de Joannis, Genitalia slide VU 946 (MNHN) [examined].

[*Nepticula rubivora*; Walsingham, 1891: 152, misidentification]

*Nepticula erythrogenella*; J. de Joannis, 1908b: 823, figs. 1, 2, pl. 15 fig. 12 (mine, adult, larva); Klimesch, 1940b: 190.

*Stigmella erythrogenella*; Gerasimov, 1952: 238; Hering, 1957: 908 (mine); Lhomme, 1963: 1192.

*Ectoedemia* (*Dechtiria*) *erythrogenella*; Emmet, 1974c: 129, 130, fig. (mine).

*Ectoedemia erythrogenella*; Emmet, 1976: 195, fig. 59, pl. 9 fig. 16.

*Trifurcula* (*Dechtiria*) *erythrogenella*; Gustafsson, 1981b: 466–468, fig. 8 (♂, ♀ genitalia, larva, mine).

*Stigmella erythrogenella* ab. *juncta* Dufrane, 1949: 9.

Diagnosis: separated from all other Rosaceae feeding *Ectoedemia* by costal spot (or costal part of fascia) placed distinctly before middle of forewing; in addition separated from *angulifasciella* complex by absence of hair-pencil in male. Externally similar to *albifasciella*-complex and *preisseckeri*, but separated by shining silver spots on forewing and absence of costal bristles in male. Male genitalia characterised by shape of valva, with almost posteriorly directed tip, and undivided, smooth gnathos.

### Description.

Male (fig. 76). Forewing length 1.76–2.28 mm ( $2.05 \pm 0.19$ , 13), wingspan 4.1–5.0 mm. Head: frontal tuft ferruginous, or orange, sometimes becoming fuscous towards crown; collar yellowish white, lighter than frontal tuft. Antenna with 33–41 segments ( $36.1 \pm 2.3$ , 10). Thorax and forewings blackish, with shining silvery white spots, one slightly before middle on costa, one in middle on dorsum, with sometimes a small spot in between, less commonly united to form a fascia (ab. *juncta*). Hindwing without hair-pencil or costal bristles.

Female. Forewing length 1.88–2.52 mm ( $2.23 \pm 0.22$ , 12), wingspan 4.1–5.6 mm. Antennae with 25–30 segments ( $27.5 \pm 1.4$ , 8).

Male genitalia (figs. 128, 129, 269, 317, 387). Capsule length 189–223  $\mu\text{m}$  ( $206.6 \pm 13.7$ , 5). Tegumen distinctly produced into slightly truncate pseuduncus. Gnathos (fig. 317) with broadly spatulate, undivided, smooth central element. Valva (fig. 269) length 150–180  $\mu\text{m}$  ( $158.6 \pm 13.2$ , 5), gradually narrowing into pointed tip, which points almost posteriorly; inner margin approximately straight. Aedeagus (fig. 387) 223–253  $\mu\text{m}$  ( $238.2 \pm 14.1$ , 5), with pointed, single carinae.

Female genitalia (figs. 207, 460). T7 with a distinct row of 4–10 long setae along posterior margin. T8 trapezoid, with two lateral patches of scales and 3–5 setae. Anal papillae with 6–11 setae. Vestibulum with vaginal sclerite, a spiculate pouch (sometimes indistinct) and a dense patch of pectinations near entrance of ductus spermathecae. Corpus bursae 440–690  $\mu\text{m}$ , covered with pectinations, except anterior part, especially closely set near vestibulum; signa similar, 300–369  $\mu\text{m}$  ( $326.8 \pm 24.9$ , 12), 3.9–5.6  $\times$  as long as wide. Ductus spermathecae with 2½–3 convolutions.

Larva. Dirty grey, but more yellowish in early stages; ganglia conspicuous. Head capsule dark brown. Ventral plates absent.

### Biology.

Hostplant. *Rubus fruticosus* L. sensu lato, especially on evergreen *Rubus ulmifolius* Schott.

Mine (fig. 499). Egg on upperside against midrib or vein. Early mine narrow gallery, following vein, often turning back, completely filled with blackish frass; finally widening into elongate blotch, with dispersed black frass in basal part, or at sides. Leaves often stained red around mine.



Life history. Univoltine, with a very long period of larval feeding. In the northern part of its range larvae from September until November, but in the south larvae can be found all over the winter until March, April and occasionally later. Some data: mid-October, Trieste, many early instar larvae, full-fed after two or three weeks; early February, south Spain, many early instar, fewer late instar larvae, completing their larval cycle in two to four weeks; late March, Sicily, few larvae left; late April, Aures mountains in Algeria, few larvae left, but still giving rise to adults; July, southern France, very few larvae, no adults reared. It is not clear if the July larvae belonged to the old generation or were just very early larvae of the new generation, but since no young larvae were present it is most likely that they belonged to the past generation and were late because of parasitism. Adults emerged in May–July, whether from autumn or early spring larvae.

#### Distribution (fig. 528).

Essentially a mediterranean species, which is abundant and widely distributed throughout the mediterranean region, both along coast and inland, although it has still to be recorded from many places. Distributed along French Atlantic coast as far as the south coast of England, where it can only be found within a short distance of the sea (Emmet, 1976), as a consequence of its supposed vulnerability to frost. The species has been recorded from Switzerland, where it might occur in Tessin, but it certainly does not occur in Austria as erroneously indicated by Emmet (1976) (Klimesch, in litt.).

Material examined: 21 ♂, 23 ♀. — Algeria: 1 ♀, Aurès, Dj. Chélia, northern slopes, 1500 m, e.l. 5.vi.1980, *Rubus ulmifolius*, 29.iv, E. van Nieukerken, G. Bryan, P. Oosterbroek (ZMA). — Cyprus: 3 ♂, 3 ♀, Limassol, Yermassoyia, 24 + 28.iii.1980, *Rubus*, B. Gustafsson (RMS). — France: 2 ♂, 4 ♀, Cannes, e.l. 27.v—12.vi.1889, *Rubus fruticosus*, iii. Walsingham (BMNH); 5 ♂, 6 ♀ (lecto- and paralectotypes), Vannes, ronce, 24.vi, 1.vii, Joannis (MNHN, MHUB); 1 ♂, 3 ♀, Vannes, e.l. 28.vi—29.vii.1910, mine 8.x.1909, Joannis, coll. Dufrane (IRSN). — Great Britain: 3 ♂, 1 ♀, Portland, Church Ope Cave, e.l. 10—17.vi.1982, *Rubus fruticosus*, 28.ix.1981, Bryan & Menken (ZMA). — Italy: 1 ♂, Sicily (Caltanissetta), W. of Manzarino, e.l. 2—4.v.1981, *Rubus ulmifolius*, 25.iii.1981, E. J. van Nieukerken (ZMA). — Spain: 1 ♂, 2 ♀, 7 km NW San Pedro de Alcántara (Málaga), 350 m, e.l. 21.iv, 15.v, 3—4.vii.1984, *Rubus ulmifolius*, E. J. van Nieukerken; 4 ♂, Sierra Blanca, 6 km N. Marbella (Málaga), El Mirador, 800 m, e.l.

12.iv—18.vi.1984, *Rubus ulmifolius*, E. J. van Nieukerken (ZMA). — Yugoslavia: 1 ♂, 3 ♀, 7 km SE Piran, Čedle (Slovenia), 300 m, e.l. 22.iv—14.v.1984, *Rubus ulmifolius*, J. J. Boomsma, E. J. van Nieukerken (ZMA).

Mines. — Algeria: Aurès, Arris, 32 km SSE Batna; Aurès, Dj. Chélia; La Calle (El Kala); E. of Morris. — Corsica: Pisciatella; Porticcio (near Ajaccio). — Cyprus: Limassol, Yermassoyia (RMS). — France: Banyuls; Port Vendres; Douelle (Lot), Le Carriol (BMNH); Bretagne (Côtes du Nord) (BMNH). — Great Britain: Harwich; Newhaven (Sussex); Emmet; Portland; St. Osyth. — Greece: Kardamyli (Messinia). — Italy: Frascati (BMNH); Roma Fiumicino; Sasso di Bordighera (BMNH); Trieste; Sicilia, Mazzarino; Sicilia, Montallegro; Sicilia, Taormina (BMNH). — Spain: Marbella; San Pedro de Alcántara; Tunisia: Ain Draham; Hammam Lif; Tabarka. — Yugoslavia: Piran; Rovinj (BMNH).

#### 40. *Ectoedemia (Ectoedemia) spiracae*

Gregor & Povolný, 1983

(figs. 77, 127, 204, 271, 318, 388, 416, 500, 549)

*Ectoedemia spiracae* Gregor & Povolný, 1983: 174—177, figs. 4—7, 9. Holotype ♂, Czechoslovakia: Cigánka Hill near Muráň, 930 m, 26.ix.1981, e.l. iii.1982, *Spiraea media*, Gregor & Povolný (Department of Entomology, Moravian Museum, Brno) [not examined].

*Stigmella* sp.; Povolný & Gregor, 1952: 237, figs. c, d (mine).

*Stigmella spireae* (sic!) Gregor & Povolný, 1955: 124, 127 (nomen nudum, no description); Hering, 1957: 1021 (mine).

*Nepticula spiracae*; Szöcs, 1968: 229.

Diagnosis: externally characterised by light head and collar, almost straight non-metallic fascia and in male yellowish-white hair-pencil and white tuft on underside forewing. Male genitalia characterised by aedeagus without carinae and valvae with serrate inner margin and inconspicuous tip. Female genitalia characterised by absence of both vaginal sclerite and spiculate pouch, and by dissimilar signa.

#### Description.

Male. Forewing length 2.42—2.52 mm (4), wingspan 5.0—5.6 mm. Head: frontal tuft and collar yellowish-orange. Antennae with 34—36 segments (4). Thorax and forewings blackish, with medial, almost straight, non-shining fascia, often interrupted. Underside of forewing with a tuft of white hair-scales arising near costal retinaculum and a large scaleless area. Hindwing with a yellowish-white hair-pencil.

Female (fig. 77). Forewing length 2.2—2.32 mm (2.25 ± 0.04, 7), wingspan 4.8—5.4 mm.

Antennae with 26—27 segments ( $26.8 \pm 0.5$ , 5). Without characteristics on underside forewing.

Male genitalia (figs. 127, 271, 318, 388). Capsule length 266—287  $\mu\text{m}$  (2). Tegumen produced into prominent triangular pseuduncus. Gnathos (fig. 318) with central element very short and inconspicuous, with wide truncate tip. Valva (fig. 271) length 206—214  $\mu\text{m}$  (2), inner margin approximately straight, but serrate by prominent setal sockets; tip an inconspicuous, pointed, inwards directed process. Aedeagus (fig. 388) 244—266  $\mu\text{m}$  (2), without carinae, a simple tube.

Female genitalia (figs. 204, 416). T7 with 6—8 short setae in an indistinct row along posterior margin. T8 appearing as a double sclerite: with two lateral patches of scales and 6—7 long setae. Anal papillae with 13—16 setae. Vestibulum smooth, without sclerite or spiculate pouch. Corpus bursae 650—660  $\mu\text{m}$ , sparsely covered with small spines or pectinations; signa clearly dissimilar, longest 394—441  $\mu\text{m}$  (3), shortest 321—343  $\mu\text{m}$  (3),  $3.8$ — $3.9 \times$  as long as wide. Ductus spermathecae with  $2\frac{1}{2}$ —3 convolutions. Larva not examined.

#### Biology.

Hostplant: *Spiraea media* Franz Schmidt.

Mine (fig. 500). Egg on leaf-underside against midrib, often in axil between midrib and lateral vein. Early mine linear, straight, following a vein, or occasionally leaf margin, filled with brown, dispersed frass; later abruptly widening into wide, irregular blotch, with blackish dispersed frass.

Life history. Probably univoltine. Larvae found in September—October. Adults reared in February—March (probably indoors) and May—June (Szócs, 1968).

#### Distribution (fig. 549).

Only known from Slovakia and Matra mountains in Hungary.

#### Remarks.

This species was discovered by Povolný & Gregor (1952), who described the mine as *Stigmella* sp. Later they named it *Stigmella spireae* Gregor & Povolný, 1955, but still based this name on mines only. This name therefore remains a nomen nudum (Code, art. 13a, 16). Later, Gregor & Povolný (1983) redescribed it under the name *Ectoedemia spireae* and designated a neotype. However, since the 1955 name is not available, the last description is to be re-

garded as the original species designation and the neotype as holotype.

In a collection of Japanese Nepticulidae, at present under study, there is a species reared from *Spiraea japonica* L. and *S. salicifolia* L., which is almost inseparable from *spireae* but has a brown hair-pencil instead of a yellowish-white one.

Material examined: 5  $\delta$ , 5  $\text{♀}$ . — Czechoslovakia: 1  $\delta$ , 1  $\text{♀}$ , (paratypes) Slovakia centr. Muráň, Huta: Cigánka, 26.ix.1981 on *Spiraea media*, Gregor & Povolný; 1  $\delta$ , 1  $\text{♀}$ , (paratypes), Slovakia or., Slovenský Raj, Čingov, 27.ix.1981 on *Spiraea media*, Gregor & Povolný (ZMA, EvN). — Hungary: 3  $\delta$ , 3  $\text{♀}$ , Mátra Hegyseg, Sástó, e.l. 13—19.v.1973, *Spiraea media*, J. Szócs (TMAB, ZMA).

Mines. — Czechoslovakia: Erzgebirge, Sitno near Banská Stianica, Gregor & Povolný (BMNH); Slovakia or., Slov. Raj., Čingov, Gregor & Povolný (ZMA). — Hungary: Mátra-Gebirge, Sástó (BMNH).

#### 41. *Ectoedemia (Ectoedemia) agrimoniae* (Frey, 1858)

figs. 78, 131, 132, 209, 270, 319, 394, 462, 501, 529)

*Nepticula agrimoniae* Frey, 1858: 44, 45. Lectotype  $\delta$  (here designated), Germany: Regensburg, Hofmann, Frey coll., Genitalia slide 22676 (BMNH) [examined].

*Nepticula agrimoniella* Herrich-Schäffer, 1860: 60. Syntypes, Germany: Regensburg (Hofmann, Angerer) (depository unknown) [not examined].

*Nepticula agrimoniella*, Herrich-Schäffer, [1861]: fig. 169; Heinemann, 1862: 312, 313; Wocke, 1871: 338; 1874: 101; Heinemann & Wocke, 1877: 757, 758; Meyrick, 1895: 722; Sorhagen, 1922: 49, pl. 3 fig. 49; Meyrick, 1928: 859.

*Nepticula agrimoniae*, Ballett Fletcher, 1882: 211; Tutt, 1899: 313—315; Rebel, 1901: 226; Meess, 1910: 479, pl. 91 fig. 68; Petersen, 1930: 68, fig. 92 ( $\delta$  genitalia).

*Dechtiria agrimoniae*; Beirne, 1945: 205, fig. 61 ( $\delta$  genitalia).

*Stigmella agrimoniae*; Gerasimov, 1952: 224; Klimesch, 1961: 759; Lhomme, 1963: 1192; Borkowski, 1970: 544, figs. 8, 23 (mine, externals).

*Stigmella (Dechtiria) agrimoniae*; Hering, 1957: 41, fig. 19a (mine).

*Trijurcula (Ectoedemia) agrimoniae*; Johansson, 1971: 245.

*Ectoedemia agrimoniae*; Bradley et al., 1972: 2; Borkowski, 1975: 491; Emmet, 1976: 191, pl. 6 fig. 1, pl. 12 fig. 22.

*Nepticula agrinomella* (sic!); Rössler, 1881: 337 [misspelling].

Diagnosis: externally similar to species of *an-*



*gulfasciella* complex, but separated by absence of hair-pencil in male, slightly pointed ovipositor in female and brown edged scape. Separated from smaller *E. hexapetalae*, *mahalebella* and *spiraeae* by dark collar and edged scape. Both male and female genitalia highly characteristic.

#### Description.

Male (fig. 78). Forewing length (1.84) 2.28—2.96 mm ( $2.58 \pm 0.21$ , 15), wingspan (4) 5.2—6.4 mm. Head: frontal tuft yellowish to ferruginous brown, sometimes completely brown; collar greyish brown, different from frontal tuft. Antennae with 35—41 segments ( $38.3 \pm 1.7$ ); scape white, but caudal edge with some brown scales. Thorax and forewings fuscous black with a yellowish silver medial fascia, constricted in middle. Hindwing without hair-pencil or costal bristles.

Female. Forewing length 2.0—2.48 mm ( $2.24 \pm 0.15$ , 20), wingspan 4—5.6 mm. Antennae with 31—36 segments ( $33.2 \pm 1.3$ , 15). Thorax and forewings darker than in male, fascia more shining silver.

Male genitalia (figs. 131, 132, 270, 319, 394). Capsule length 214—240  $\mu$ m ( $225.7 \pm 8.4$ , 6). Tegumen produced into pointed, cuspidate pseuduncus. Gnathos (fig. 319) with triangular, pointed central element, with smooth margins. Valva (fig. 270) length 163—189  $\mu$ m ( $174.3 \pm 10.7$ , 6), widest at base, distinctly constricted below pointed and inwards curved tip. Aedeagus (fig. 394) 184—227  $\mu$ m ( $204.3 \pm 16.6$ , 6), dorsal carinae inserted clearly below apex, each divided into 4—5 pointed teeth; ventral projection with some small spines.

Female genitalia (figs. 209, 462). T7 with 6—8 small setae along posterior margin. T8 in form of a narrow curved band, almost split in middle, with a group of scales and 4—7 setae on either side. Anal papillae narrow, with 7—11 setae. Vestibulum without vaginal sclerite, or spiculate pouch. Corpus bursae 440—640  $\mu$ m, completely covered with pectinations; signa similar, cells particularly spiny, length 180—300  $\mu$ m ( $237.9 \pm 35.0$ , 14),  $2.3\text{--}3.6 \times$  as long as wide. Ductus spermathecae with 3—3½ convolutions.

Larva. Greenish yellow, with conspicuous brown ganglia, head-capsule brown. Without ventral plates.

#### Biology.

Hostplants. *Agrimonia eupatoria* L. and *Aremonia agrimonoides* (L.) DC. (Greece only).

Mine (fig. 501). Egg on leaf-underside. Early

mine narrow tortuous gallery, sometimes following vein, with broken linear frass, occasionally partly contorted; later widening into a wide irregular gallery, or elongate blotch with dispersed frass. Cocoon made in mine.

Life history. Univoltine, larvae from the end of August until October, pupae inside the mine. Adults from May to July.

#### Distribution (fig. 529).

Widespread in Central Europe, the Balkans and France, local in South England and south-east Sweden. Not recorded from Denmark, the Netherlands, Belgium, Iberian Peninsula or Italy.

Material examined: 49 ♂, 67 ♀, 91 ex. — Austria: 4 ♂, 11 ♀, Hainburg: Hundsheimer Berg, 200—400 m, e.l. 15—28.v.1984, *Agrimonia eupatoria*, J. J. Boomsma & E. J. van Nieukerken (ZMA). — Czechoslovakia: 1 ♀, Praha (Prag), Pock. (NMW). — Germany, West: 1 ♀, Bayern, 1858 (NMW); 1 ♂, 1 ♀, Frankfurt am Main, coll. Staudinger (MHUB); 1 ♂, 1 ♀, Hafen, e.l. iv.1928, *Agrimonia eupatoria*, A. Wörz (LNK); 2 ♂, München, coll. Staudinger; 1 ♂, 2 ♀, Regensburg, coll. Staudinger (MHUB); 1 ♂, 1 ♀, (lecto- and paralectotype of *agrimonoides*), Regensburg, Hofmann (BMNH); 2 ♂, 1 ♀, Wolfenbüttel, [Heinemann] (MHUB). — Germany, without further data: 1 ♀, Jos. Mann; 1 ♂, 1 ♀, ex coll. v. Heinemann (RMNH); 1 ♀, 1869, Lederer (NMW). — Germany, East: 1 ♂, 1 ♀, Berlin-Finkenkrug, e.l. 15—21.iii.1930, Hering; 1 ♀, Berlin Frohnau, e.l. 10.v.1924, Hering; 91 ex., Berlin, MAJ, *Agrimonia*, Hering; 5 ♂, 6 ♀, Berlin Rudersdorf, e.l. 22.iii—10.iv.1928, Hering; 7 ♂, 7 ♀, Chorin (Mark), e.l. 1—30.iv.1921, Hering (MHUB); 6 ♂, 6 ♀, Potsdam, e.l. 16—22.iii.1894, Hinneberg (MHUB, NMW, ZMA); 1 ♀, [Potsdam] e.l. 16.ii.1892, *Agrimonia* (ZMA). — Great Britain: 3 ♀, Box Hill, e.l. 25.vi.1936, 11.vi.1938, 6.vi.1939, S. Jacobs (ZMA); 2 ♂, 1 ♀, W. of Hadleigh (Essex), South Benfleet, e.l. 29.vi—7.vii.1982, G. Bryan & S. B. J. Menken (ZMA); 1 ♂, 1 ♀, no further data, Tyerman, ex coll. BMNH (ZMA). — Greece: 4 ♂, 2 ♀, Evvoia: Dhírfis Oros, S. slopes 700—900 m, e.l. 2—18.v.1981, *Aremonia agrimonoides*, S. B. J. Menken & E. J. van Nieukerken; 1 ♂, 3 ♀, Frangista (Evrítania), valley, 600 m, e.l. 16.v—3.vi, 1981, *Aremonia* and *Agrimonia*, S. B. J. Menken & E. J. van Nieukerken; 2 ♂, 6 ♀, Katsiká (Ioánnina) near Limni Ioánninon, 480 m, e.l. 7—15.v.1981, *Agrimonia eupatoria*, S. B. J. Menken & E. J. van Nieukerken; 2 ♂, 1 ♀, Métésovon (Ioánnina), 950—1000 m, e.l. 14—22.v.1981, *Agrimonia eupatoria*, S. B. J. Menken & E. J. van Nieukerken (ZMA); 1 ♂, 2 ♀, Vardhoúsia O., (Fthiótis), Dafní, 7 km SE Mármara, 1100 m, e.l. 5—14.v.1981, *Agrimonia eupatoria*, S. B. J. Menken & E. J. van Nieukerken. — Switzerland: 1 ♂, no further data, 1869 (NMW). — USSR: 3 ♂, 4 ♀,



Bendery (Tighina), Bessarabia, e.l. 10.iv—20.v.1931, *Agrimonia eupatoria*, Hering (MHUB).

Mines. — On *Agrimonia eupatoria*. — Austria: Hundsheimer Berg near Hainburg. — Germany: Berlin-Frohnau, Hering (BMNH). — Great Britain: Hadleigh; Dorking, Box Hill (Surrey). — Greece: SE Mármara, Vardhoúsia Ori (Fthiótis). — USSR: Bendery (Tighina), Hering (BMNH). — Yugoslavia: Otočac. On *Aremonia agrimonoides*. — Greece: Evvoia, Dhírfis Oros; SE Mármara, Vardhoúsia Ori (Fthiótis); Frangísta (Evritanía); Fournás (Evritanía).

42. *Ectoedemia (Ectoedemia) hexapetalae*  
(Szöcs, 1957) comb. n.

(figs. 79, 130, 210, 272, 320, 389, 403, 404, 463, 502, 549)

*Nepticula utensis* Weber var. *hexapetalae* Szöcs, 1957: 322, 323. Holotype ♂, Hungary: Budapest, Sashegy, 24.vii.1956 e.l., Szöcs, Genitalia slide 944 Gozmány (TMAB) [examined].

*Nepticula hexapetalae*; Szöcs, 1965: 79; 1968: 228.

*Trifurcula hexapetalae*; Kasy, 1980: 47.

Diagnosis: this species differs externally from most species of the *angulifasciella* group by its small size, light collar, straight non-metallic fascia, and absence of hair-pencil in male. It can possibly be confused with *E. mahalebella*, in which case the genitalia should be examined. Male genitalia are immediately recognised by the width and the dorsal spinose process of the aedeagus. Female genitalia are easy to separate from *mahalebella* by shape and position of signa.

Description.

Male. Forewing length 1.96—2.12 mm (2.05 ± 0.07, 6), wingspan 4.4—4.7 mm. Head: frontal tuft yellowish orange to orange brown; collar slightly lighter. Antennae with 30—33 segments (32 ± 1.2, 5). Thorax and forewings brownish black with a medial, almost straight fascia, dull white, not shining. Hindwing without hair-pencil or costal bristles.

Female (fig. 79). Forewing length 1.68—2.04 mm (1.89 ± 0.13, 8), wingspan 3.7—4.6 mm. Antennae with 24—26 segments (24.9 ± 0.8, 8).

Male genitalia (figs. 130, 272, 320, 389, 403, 404). Capsule length 197—240 μm (3), wider than long. Tegumen distinctly produced into a rounded pseuduncus. Gnathos (fig. 320) divided into short distal element, and basal part with serrate margin. Valva (fig. 272) length 167—184 μm (3), relatively broad, inner margin almost straight, but slightly concave below pointed tip. Aedeagus (figs. 389, 403, 404) 261—287 μm (3), distinctly longer than capsule, relatively broad;

with pair of single or bifid carinae and a single dorsal projection with many spines.

Female genitalia (figs. 210, 463). T7 with 4—6 scattered setae along posterior margin. T8 with two lateral patches of scales and 3—5 setae. Anal papillae with 7—18 setae. Vestibulum with incomplete vaginal sclerite with an indistinct ventral projection, without spiculate pouch. Corpus bursae 460—630 μm, completely covered by pectinations, especially dense near vestibulum; signa similar, with only slight differences in length, 197—326 μm (254.7 ± 47.5, 7), 2.6—3.1 × as long as wide. Ductus spermathecae with 2—3 convolutions.

Larva. Pale green, according to Szöcs (1957).

Biology.

Hostplant. *Filipendula vulgaris* Moench (= *hexapetala* Gilibert).

Mine (fig. 502). Egg on leaf-underside. Mine narrow gallery, often following leaf-margin; early mine filled with brown dispersed frass, later black dispersed frass leaving clear margins.

Life history. Probably bivoltine. Larvae most abundant in June and July, again in lower numbers in August and October (Szöcs, 1968). Adults from summer larvae emerged within a month, from autumn larvae in May (only 1 specimen examined). The only specimen taken at light flew in May.

Distribution (fig. 549).

Still only known from the region near Budapest and the Fischawiesen near Gramatneusiedl in the Vienna region. The population of the latter locality appears to be threatened, because these meadows are yearly completely mowed (pers. comm. Kasy), without leaving any old leaves for the autumn generation.

Remarks.

Originally described as variety of *utensis* (= *angulifasciella*) only, but *E. hexapetalae* appears to be a very distinctive species. Together with *terebinthivora* these are the only European *Ectoedemia* species which are known to be bivoltine.

Material examined: 6 ♂, 9 ♀. — Austria: 1 ♀, Gramatneusiedl, Fürbachwiesen (= Fischawiesen), e.l. 28.vii.1972, F. Kasy; 3 ♀, idem, e.l. 19—20.vii.1979; 1 ♂, idem, 30.v.1979, at light (NMW). — Hungary: 2 ♂, 2 ♀, Budaörs, e.l. 15.vii.1962, 3.vii.1964, 6—8.vii.1968, J. Szöcs; 1 ♂, 1 ♀, Budaörs, Törökugrató, e.l. 29.vi.1968, 21.v.1979, J. Szöcs; 1 ♂, 1 ♀, (Holotype and paratype), Budapest, Sashegy, e.l. 24—26.vii.1956, J. Szöcs (TMAB).

Mines. — Austria: Gramatneusiedl, Fischawiesen, leg. Kasy. — Hungary: Budapest, Sasshegy, leg. Szöcs (BMNH).

### The *Ectoedemia angulifasciella* complex

This is a complex of four very similar species, mining on Rosaceae. The status of the four taxa has recently been discussed by Wilkinson et al. (1983), where it was shown that the four taxa form two pairs of sibling species. In that paper the forms *schleichiella* and *staphyleae* were not treated, but it is shown here that these are synonyms of *E. angulifasciella* and *atricollis* respectively.

As in the other complexes treated here, the first species (*angulifasciella*) is described fully, and the other species only as far as they differ from it.

### 43. *Ectoedemia (Ectoedemia) angulifasciella* (Stainton, 1849)

(figs. 80, 133, 211, 212, 273, 321, 390, 464, 503, 532)

*Nepticula angulifasciella* Stainton, 1849: 29. Syntypes, England, Stainton (depository unknown) [not examined].

*Nepticula schleichiella* Frey, 1870: 286. Lectotype ♀ (here designated), Switzerland: Zürich, Frey, Genitalia slide 22567 (BMNH) [examined]. **Syn. nov.**

*Nepticula utensis* Weber, 1937a: 669, fig. 2. Lectotype ♂ (here designated), Switzerland: Zürich, Ute, 28.ix.1935, *Sanguis. offic.*, Z. 2368, Weber, Genitalia slide ETH 1240 (ETHZ) [examined]. **Syn. nov.**

*Nepticula minorella* Zimmermann, 1944: 118, 119, figs. 5, 7. Lectotype ♂ (here designated), Austria: Gumpoldskirchen near Wien, e.l. 26.vii.1943, *Poterium min.*, F. Zimmermann (labelled paratypus). Genitalia slide No. 763/1943 M. Hering (on pin) (MHUB) [examined]. **Syn. nov.**

? *Nepticula brunniella* Sauber, 1904, Syntype mines, Germany, West: Hamburg, Sorhagen (depository unknown) [not examined].

*Nepticula angulifasciella*; Stainton, 1854: 304; Herrich-Schäffer, 1855: 350; Stainton, 1855: 88—97, pl. 1 fig. 3; Frey, 1857: 417, 418; Stainton, 1859: 435; Heinemann, 1862: 314, 315; Wocke, 1871: 338; 1874: 101; Heinemann & Wocke, 1877: 758, 759; Sorhagen, 1886: 308; Meyrick, 1895: 859; Tutt, 1899: 308—310; Rebel, 1901: 226; Meess, 1910: 479; Meyrick, 1928: 859; Petersen, 1930: 69, fig. 94 (♂ genitalia); Szöcs, 1965: 78.

*Dechthiria angulifasciella*; Beirne, 1945: 205 (partim, not fig. 68); Vári, 1951: 196, 197, figs. 13, 17 (♂ genitalia, identity).

*Stigmella angulifasciella*; Klimesch, 1951: 62; Gerasimov, 1952: 225; Klimesch, 1961: 759; Lhomme, 1963: 1193; Borkowski, 1969: 112.

*Stigmella (Dechthiria) angulifasciella*; Hering, 1957: 902 (mine).

*Trifurcula (Ectoedemia) angulifasciella*; Johansson, 1971: 245.

*Ectoedemia angulifasciella*; Bradley et al., 1972: 2; Emmet, 1973: 178—180 (differences with *atricollis*); 1976: 192, pl. 6 fig. 2, pl. 12 fig. 24; Wilkinson et al., 1983: 211—224, figs. 1, 2, 9 (specific status).

*Ectoedemia angulifasciella* (partim); Borkowski, 1975: 492.

*Trifurcula angulifasciella* (partim); Karsholt & Nielsen, 1976: 18.

*Nepticula schleichiella*; Wocke, 1871: 338; Heinemann & Wocke, 1877: 759, 760; Rebel, 1901: 226; Meess, 1910: 479.

*Stigmella schleichiella*; Gerasimov, 1952: 259; Hering, 1957: 937 (mine).

*Stigmella utensis*; Klimesch, 1948: 72, 73, figs. 50, 51 (♂ genitalia).

*Stigmella minorella*; Klimesch, 1961: 739.

? *Nepticula brunniella*; Sorhagen, 1922: 59, fig. 70.

Diagnosis: male characterised by the combination of a yellowish-orange collar, an oblique metallic fascia and a white hair-pencil. *E. spiraeae* is very similar, but has almost no metallic fascia and is usually smaller. Male genitalia characterised by the shape of the valva, with sinuous inner margin. Female separated from *agrimoniae*, *atricollis* and *arcuatella* by light collar, *E. mahalabella* is very similar, but usually smaller and with very different signa.

### Description.

Male (fig. 80). Forewing length (excluding specimens reared from *Filipendula*) 2.2—2.8 mm ( $2.56 \pm 0.18, 21$ ), wingspan 5.2—6.6 mm. Including *Filipendula* specimens: forewing length 1.92—2.8 ( $2.47 \pm 0.25, 25$ ), wingspan 4.4—6.6 mm. Head: frontal tuft and collar pale ochreous to ferruginous, usually lighter than in *atricollis*; collar often slightly lighter. Antennae with 29—35 segments ( $32.2 \pm 1.6, 18$ ). Thorax and forewings fuscous black, with a medial, oblique, shining metallic silver fascia, rarely interrupted in middle. Underside of forewing with small scaleless area. Hindwing with white hair-pencil and a few dark scales along costa.

Female. Forewing length (excluding specimens reared from *Filipendula*) 2.04—2.68 mm ( $2.52 \pm 0.18, 12$ ), wingspan 4.7—6.1 mm. Including *Filipendula* specimens: forewing length 1.92—2.68 ( $2.40 \pm 0.26, 16$ ), wingspan 4.5—6.1 mm. Antennae with 25—29 segments ( $27.1 \pm 1.0, 13$ ).

Male genitalia (figs. 133, 273, 321, 390). Capsule length 210—257  $\mu\text{m}$  ( $241.0 \pm 16.6, 9$ ). Te-



gumen distinctly produced into truncate pseuduncus. Gnathos (fig. 321) with central element divided, distal part spatulate, basal part with serrate margin. Valva (fig. 273) length 159—193  $\mu\text{m}$  ( $175.3 \pm 11.6$ , 11), inner margin sinuous, forming a slight, but distinct rounded bulge in distal half, so that inner margin forms a right angle with pointed tip. Aedeagus (fig. 390) 214—274  $\mu\text{m}$  ( $250.1 \pm 18.3$ , 11), slightly constricted beyond middle, carinae single or bifid, not sharply pointed, with many small spines at base.

Female genitalia (figs. 211, 212, 464). T7 without setae in a row. T8 with two lateral patches with many scales and about 4—8 setae; anal papillae with 5—9 setae. Vestibulum with a vaginal sclerite and a "spiculate" pouch without spines. Corpus bursae 400—570  $\mu\text{m}$ , almost completely covered with pectinations; signa dissimilar, longest 249—381  $\mu\text{m}$  ( $326.1 \pm 38.0$ , 10), shortest 227—356  $\mu\text{m}$  ( $289.5 \pm 37.1$ , 9), 3.3—4.6  $\times$  as long as wide. Ductus spermathecae with  $2\frac{1}{2}$ —3 convolutions.

Larva. Greenish white, with distinct ganglia. Head-capsule and prothoracic plate dark brown. In 2nd and 3rd instar with chain of dark brown ventral plates.

### Biology.

Hostplants: *Rosa* spp., including evergreen *Rosa sempervirens* L., occasionally on *Sanguisorba minor* Scop., *S. officinalis* L. and *Filipendula vulgaris* Moench (in Hungary only).

Mine (fig. 503). Egg on leaf-underside. Early mine highly contorted gallery filled with brown, contorted frass; later widening into large irregular blotch or wide gallery with irregular dispersed black frass.

Life history. Univoltine. Larvae from end of August to early November. S. E. Whitebread (in litt.) found some larvae in July in Switzerland. Adults flying from the middle of June to the end of July. May records probably refer all to indoor rearing.

### Distribution (fig. 532).

Widespread in Europe, from southern Scandinavia to Greece. Not yet recorded from Ireland, Iberian Peninsula and central Balkan.

### Remarks.

In the Stainton collection there are only *angulifasciella* specimens collected after 1849, thus without syntype status. The type specimens were not reared, but were later recognised by

Stainton as being the same species as the rose miner. The identity of this species has been discussed by Wilkinson et al. (1983), with exception of the *Sanguisorba* form. Three authors described the *Sanguisorba* form: Frey as *schleichiella*, Weber as *utensis* (from the same locality as Frey!) and Zimmermann as *minorella*. The lectotypes of these taxa are morphologically identical with *angulifasciella*, and also the biology, except the foodplant, is similar. Electrophoresis of one larva collected in the Pyrenees on *Sanguisorba minor* showed that this form is also genetically identical with *angulifasciella* (Menken, in preparation). The conclusion is that *angulifasciella* is an oligophagous species, which most commonly feeds on *Rosa*. Szöcs also collected the species in numbers on *Filipendula vulgaris* in Hungary. These specimens are much smaller than normal *angulifasciella* probably due to the size of the leaves. The measurements of the adults have thus been given both excluding and including these specimens.

*N. brunniella* Sauber has been described on the basis of some mines collected by Sorhagen in Hamburg. Judging from Sorhagen's (1922) description and figure they could also belong to *angulifasciella*.

Material examined: 38  $\sigma$ , 28  $\varphi$ , 42 ex. — Austria: 3  $\sigma$ , (lecto- and paralectotypes of *minorella*), Gumpoldskirchen near Wien, e.l. 14.vi—26.vii.1943, *Poterium min.*, Zimmermann (MHUB); 1  $\sigma$ , Gumpoldskirchen, Glaslauterriegel, 28.vii.1972, F. Kasy; 2  $\sigma$ , Hundshheimer Berg (near Hainburg), 17.vii.1977, 15.vii.1980, F. Kasy; 1  $\varphi$ , Linz, 2.v.1910, Knitsche (NMW). — France: 1  $\sigma$ , 1  $\varphi$ , Chaville, e.l. 31.v., Joannis (MNHN). — Germany, West: 1  $\sigma$ , Bayers, 1858 (NMW); 2  $\sigma$ , 1.5 km NW Birresborn (Rhl.-Pf.), Vulkanberg, 460 m, e.l. 24—27.vi.1983, *Rosa*, Alders & Van Nieuwerkerken (ZMA); 2  $\varphi$ , Braunschweig, Heinemann, coll. Staudinger (MHUB); 2  $\sigma$ , 1  $\varphi$ , Stuttgart, 30.vi.1883; 19.vii.1886 (MHUB, NMW); 1  $\sigma$ , no data, ex coll. Heinemann, coll. Snellen (RMNH). — Germany, East: 1  $\sigma$ , 1  $\varphi$ , Friedland, 1, 9.v.1885, Stange; 5  $\sigma$ , 3  $\varphi$ , Rachlau, e.l. 1897, *Rosa canina*, Schütze; 2  $\varphi$ , Sachsenberg, Nordhausen, e.l. 29.vi.1899, *Rosa*, Petry (MHUB). — Hungary: 5  $\sigma$ , 4  $\varphi$ , Szár, e.l. 17—24.vi.1968, *Filipendula vulgaris*, J. Szöcs (TMAB). — Netherlands: 3  $\sigma$ , Nunspeet, e.l. 14—22.vii.1946, *Rosa*, L. Vári; 8  $\sigma$ , 5  $\varphi$ , Ootmarsum, Achter de Voort, e.l. 10—14.vii.1981, *Rosa*, 15.x.1980, Andeweg & Van Nieuwerkerken; 3  $\varphi$ , Winterswijk, quarry, e.l. 26.vii.1979, 12—13.vii.1982, Van Nieuwerkerken (ZMA). — Poland: 42 ex., Krosno Odr. (Crosen a. Oder), e.l. 10—26.vi.1930, *Rosa canina*, Hering; 3  $\sigma$ , 3  $\varphi$ , idem, e.l. 15—23.v.1932; 1  $\sigma$ , Silesia, Wocke (MHUB); 1  $\sigma$ , Silesia, 1872, Staudinger (NMW); 2  $\sigma$ , 4  $\varphi$ , Wroclaw (Breslau), e.l.



iv.1872, *Rosa* (Wocke) (MHUB). — Switzerland: 2 ♀ (lecto- and paralectotype of *schleichiella*), Zürich, Frey (BMNH); 1 ♂ (lectotype of *utensis*, see above); 2 ♂, 1 ♀, Zürich, Uto, mine 29.ix.1936, *Sanguisorba officinalis*, Weber (ETHZ). — Yugoslavia: 3 ♂, 2 ♀, Selce, 4 km SE Crikvenica (Hrvatska), a.s.l., e.l. 24.v—18.vi.1984, J. J. Boomsma & E. J. van Nieukerken (ZMA). — No data: 1 ♂, *Rosa* (ZMA); 2 ♀, e.l. 6.vi.1884, v. 1903, *Rosa* (NMW).

Mines. — On *Rosa* spp. — Austria: Gumpoldskirchen. — France: Andlau; Arvieu; Barr; Corse, Porticcio; Modane. — Germany, West: Alendorf; Birresborn; Hillesheim; Klotten. — Great Britain: Saffron Walden; Takeley; Tintern. — Greece: Fournás, Evritania; Oíti Oros, Fókis + Fthiótis; Olympia; Parnos Oros, Attika. — Italy: Picinisco; Trento. — Netherlands: Cadier en Keer; Epen; Kunrade; De Lutte; Ootmarsum; Winterswijk; Wijlre. On *Sanguisorba minor*. — France: Porté-Puymorens. — Germany, West: Alendorf.

#### 44. *Ectoedemia* (*Ectoedemia*) *atricollis*

(Stainton, 1857)

(figs. 15—17, 28, 81, 134, 213, 214, 274, 323, 391, 465, 504, 505, 533)

*Nepticula atricollis* Stainton, 1857: 112. Lectotype ♀ (here designated), England, ex Boyd Coll. B.M., 1813—391, ♀ 5788, *Nepticula atricollis* Stn. Type, Genitalia slide 22617 (BMNH) [examined].

*Nepticula atricollella* Doubleday, 1859: 36 (unjustified emendation).

*Nepticula aterrima* Wocke, 1865: 270. Lectotype ♂ (here designated), Poland: Freiburg, Silesia, e.l. iv.1862, *Crataegus*, Wocke, Genitalia slide VU 2325 (ZIAS) [examined].

*Nepticula malivora* Toll, 1934b: 70, 83, pl. 2 fig. 1. Nomen nudum (no description or diagnosis, mine only).

*Nepticula atricollis* var. *aterrimoides* Skala, 1940: 143. Nomen nudum (no description or diagnosis).

*Nepticula staphyleae* Zimmermann, 1944: 117, 118, figs. 4, 6. Lectotype ♂ (here designated), Austria: Gumpoldskirchen near Wien, e.l. 12.vi.1943, *Staphylea pinnata*, F. Zimmermann, Genitalia slide VU 1488 (MHUB) [examined]. **Syn. nov.**

*Nepticula atricollis* var. *prunivora* Skala 1941: 1977. Nomen nudum (no description or diagnosis, mine only).

*Nepticula atricollis*; Stainton, 1859: 435; 1862: 228—235, pl. 11 fig. 1; Heinemann, 1862: 313, 314; Nolcken, 1871: 782; Wocke, 1871: 338; 1874: 101; Heinemann & Wocke, 1877: 758; Meyrick, 1895: 722; Tutt, 1899: 304—306; Rebel, 1901: 226; Meess, 1910: 479; Meyrick, 1928: 859; Petersen, 1930: 69, fig. 93 (♂ genitalia); Klimesch, 1936: 208; Zimmerman, 1944: fig. 6 a—c (♂ genitalia); Szöcs, 1965: 79.

*Dechthiria atricollis*; Vári, 1951: 197 (comparison with *angulifasciella*); Emmet, 1971: 171, 240, 241.

*Stigmella atricollis*; Gerasimov, 1952: 228, Klimesch,

1961: 759; Lhomme, 1963: 1193; Borkowski, 1969: 104.

*Stigmella* (*Dechthiria*) *atricollis*; Hering, 1957: 349, 664, 690, 835, 854, 1010; figs. 229b, 408a.

*Trifurcula* (*Ectoedemia*) *atricollis*; Johansson, 1971: 245.

*Ectoedemia atricollis*; Bradley et al., 1972: 2; Emmet, 1973: 178—180 (differences with *angulifasciella*); Emmet, 1976: 193, pl. 6 figs. 4, 5, pl. 12 fig. 25; Wilkinson et al., 1983: 211—224, figs. 3, 4, 10 (specific status).

*Dechthiria angulifasciella* (partim); Beirne, 1945: 205, fig. 68 (♂ genitalia).

*Ectoedemia angulifasciella* (partim); Borkowski, 1975: 492.

*Trifurcula angulifasciella* (partim); Karsholt & Nielsen, 1976: 18.

*Nepticula aterrima*; Wocke, 1871: 338, 1874: 102; Heinemann & Wocke, 1877: 763; Rebel, 1901: 227; Meess, 1910: 480.

*Stigmella aterrima*; Gerasimov, 1952: 228; Lhomme, 1963: 1198.

*Nepticula malivora*; Toll, 1936: 411.

*Nepticula staphyleae*; Szöcs, 1965: 79.

*Stigmella staphyleae*; Hering, 1957: 1027 (mine); Klimesch, 1961: 759.

*Ectoedemia staphyleae*; Borkowski, 1975: 493.

Diagnosis: separated from *angulifasciella*, *mahalebella* and *spiraeae* by dark collar, from *agrimoniae* by hair-pencil in male and blunt ovipositor in female (pointed in *agrimoniae*), from *rubivora* by head colour and from *spinoseella* by size, and dark coloured hair-pencil in male *spinoseella*. *E. arcuatella* can hardly be distinguished from *atricollis*, except by smaller size, much shorter signa and shorter aedeagus of *arcuatella*.

#### Description.

Male. Forewing length 2.16—2.56 mm (2.39 ± 0.12, 20), wingspan 4.8—6.0 mm. Head: frontal tuft orange to ferruginous (rarely black); collar dark fuscous to black. Antennae with 29—39 segments (33.3 ± 2.4, 16). Hindwing with white hair-pencil, surrounded by some dark brown scales, especially along costa. Further as *angulifasciella*.

Female (fig. 81). Forewing length 2.28—2.80 mm (2.56 ± 0.14, 14), wingspan 5.2—6.2 mm. Antennae with 26—30 segments (27.7 ± 1.2, 12).

Male genitalia (figs. 134, 274, 323, 391). Capsule length 270—287 μm (278.6 ± 6.9, 11). Gnathos fig. 322. Valva (fig. 274) length 176—206 μm (189.4 ± 8.5, 11), inner margin almost straight, forming an obtuse angle with pointed

tip. Aedeagus (fig. 391) 261—287  $\mu\text{m}$  ( $273.1 \pm 8.8$ , 11), hardly constricted. Further as *angulifasciella*.

Female genitalia (figs. 213, 214, 465). T8 with 3—4 setae at both sides. Anal papillae with 6—9 setae. Spiculate pouch with few almost invisible spines. Corpus bursae 495—660  $\mu\text{m}$ ; longest signum (360) 411—489  $\mu\text{m}$  ( $435.5 \pm 32.3$ , 12), shortest (356) 377—446  $\mu\text{m}$  ( $405 \pm 24.4$ , 12),  $3.8\text{--}5.0 \times$  as long as wide. Ductus spermathecae with 3—3 $\frac{1}{2}$  convolutions.

Larva. Greenish white, with distinct ganglia. Head-capsule and prothoracic plate black. In 2nd and 3rd instar with chain of black ventral plates.

### Biology.

Hostplants. Oligophagous on Rosaceous trees: most abundant on *Crataegus* spp., common on *Malus sylvestris* Miller, *Pyrus communis* L. and *Prunus avium* L., occasionally on *Prunus mahaleb* L. and *P. cerasifera* Ehrh. Records on *Prunus spinosa* L. probably all refer to *E. spinosella*. In east Central Europe also common on *Staphylea pinnata* L. (Staphyleaceae).

Mine (figs. 504, 505). Egg on leaf-underside. Early mine linear, following leaf-margin, or slightly contorted, filled with brown frass; later widening into large blotch with scattered black frass.

Life history. Univoltine. Larvae from late August until late October, commonest in September. Adults slightly earlier than *angulifasciella*, from early June until late July. May records probably refer to indoor rearing.

### Distribution (fig. 533).

Widespread in Europe, from Central Sweden to Central Italy. Not yet found in a large part of the mediterranean region and Ireland.

### Remarks.

Beirne (1945) and Borkowski (1975) synonymised this species with *angulifasciella*, but Wilkinson et al. (1983) showed that both species are separate, genetically isolated entities.

*N. aterrima* Wocke is just a dark aberration of *atricollis*. The nomina nuda *malivora* Toll and *aterrimoides* Skala are based on mines of *atricollis*.

*N. staphyleae* Zimmermann is morphologically identical to *atricollis*, the adult, larva, and mine being completely similar. The hostplant of *staphyleae* is however unrelated to the Rosaceae. By analysis of allozymes (Menken, in

preparation) the larvae collected from *Staphylea* in the autumn of 1983 are shown to be genetically identical to those of sympatric *atricollis* from *Crataegus*. Therefore *staphyleae* is here synonymised with *atricollis*.

Material examined: 64  $\delta$ , 59  $\eta$ , 1 ex. — Austria: 3  $\delta$ , 1  $\eta$  (lecto- and paralectotypes of *staphyleae*), Gumpoldskirchen near Wien, e.l. 12.vi—21.vii.1943, *Staphylea pinnata*, Zimmermann (MHUB); 1  $\delta$ , 1  $\eta$ , 1 km N. Gumpoldskirchen, Richardshof, e.l. 5.vi.1984, *Staphylea pinnata*, J. J. Boomsma & E. J. van Nieukerken (ZMA); 1  $\eta$ , Klosterneuburg, Buchberg, e.l. 24.v.1937, Preissecker; 1  $\eta$ , Linz, 9.ii.1911, Knitsche; 1  $\delta$ , Wien, Haschbg., e.l. 22.v.1937, Preissecker (NMW). — Czechoslovakia: 1  $\delta$ , 1  $\eta$ , Dečín (Tetschen, Elbe), e.l. 11, 23.vi.1943, *Crataegus*, Hering (MHUB). — France, 2  $\delta$ , 3  $\eta$ , Clamart (Hauts de Seine), e.l. 4.vi, Aubépine (*Crataegus*), De Joannis (MNHN). — Germany, West: 3  $\delta$ , 2  $\eta$ , Freiburg, e.l. iv.1965, Pyr. mal., 1  $\eta$ , Hannover, Glitz; 2  $\eta$ , Wolfenbuttel, [Heinemann] (MHUB). — Germany, East: 10  $\delta$ , 9  $\eta$ , Berlin-Finkenkrug, e.l. 31.v—10.vi.1930, *Pyrus malus*, Hering; 2  $\delta$ , 4  $\eta$ , Bredow b. Nauen, e.l. 25.iii—2.iv.1925, *Malus silvestris*, Hering; 2  $\delta$ , 2  $\eta$ , Rüdingsdorf, Nordhausen, e.l. 21.v—7.vi.1921, 1.vi.1925, *Crataegus*, Petry; 2  $\delta$ , 4  $\eta$ , Rachlau, e.l. i.1888, 1897, *Pyrus malus*, Schütze (MHUB). — Great Britain: 1  $\eta$  (lectotype, see above). — Hungary: 2  $\delta$ , Budapest, e.l. 16.vi.1953, *Staphylea*, J. Szöcs; 1  $\eta$ , Budapest, Csittepéta, e.l. 30.v.1978, *Staphylea pinnata*, J. Szöcs; 1  $\eta$ , Normafa, e.l. 14.v.1978, *Staphylea pinnata*, J. Szöcs; 1  $\eta$ , Budapest, Zugliget, e.l. 23.vi.1957, *Staphylea pinnata*, J. Szöcs (TMAB). — Italy: 1  $\eta$ , Formello (Roma), Valle delle mad. d. Sorbo, e.l. 5.vi.1984, *Crataegus monogyna*, S. B. J. Menken (ZMA). — Netherlands: 32  $\delta$ , 20  $\eta$ , from following localities; Ankeveense Plassen, Castricum, Loosdrecht, Nederhorst den Berg, St. Pietersberg, Weesp, Winterswijk and own breeding, reared from *Crataegus*, *Malus* or *Pyrus* (RMNH, ZMA). — Poland: 1  $\delta$  (lectotype of *aterrima*, see above); 2  $\delta$ , 1  $\eta$ , Silesia, Wocke, Staudinger (MHUB, ZMA). — Switzerland: 1  $\delta$ , 1  $\eta$ , 1869, 1870 (NMW).

Mines. On *Crataegus*. — Austria: Hundsheimer Berg near Hainburg; Orth am Donau. — Germany, West: Bad Honnef; Birresborn; Gerolstein. — Great Britain: Chepstow; Churchill; New Forest; Takeley. — Netherlands: many localities. — Italy: Formello; Opi. On *Malus*. — Austria: Orth am Donau. — Great Britain: Stapleford Abbots. — Italy: Picinisco. — Netherlands: Denekamp; Hilversum; Leiden; Nederhorst ten Berg; Rockanje; Wassenaar; Winterswijk. On *Mespilus germanica*. — Netherlands: Winterswijk. On *Prunus avium*. — Austria: Hof am Leithagebirge. — Germany, West: Bad Honnef. — Netherlands: Oud Valkenburg; Rijckholt; Sibbe; St. Geertruid; Winterswijk. On *Prunus cerasifera*. — Rumania: Cocoş, Niculiţel, Tulcea, 1.ix.1973, leg. Draghia. On *Prunus mahaleb*. — Germany, West: Klotten. *Pyrus*. — Italy: Opi. — Netherlands: Hilver-



sum; Leiden; Wassenaar; Winterswijk. — Yugoslavia: Slavonska Požega. On *Staphylea pinnata*. — Austria: Gumpoldskirchen; Hundsheimer Berg near Hainburg. — Yugoslavia: N. Bihac.

#### 45. *Ectoedemia (Ectoedemia) arcuatella*

(Herrich-Schäffer, 1855)

- (figs. 82, 136, 215, 275, 323, 392, 466, 506, 534)  
*Nepticula arcuatella* Herrich-Schäffer, 1855: 354.  
 Lectotype ♂ (here designated) identical with lectotype of *N. arcuata* Frey, see below.  
*Nepticula arcuata* Frey, 1856: 384, 385. Lectotype ♂ (here designated), Switzerland: Zürich, Frey, Genitalia slide 22678 (BMNH) [examined].  
*Nepticula arcuosella* Doubleday, 1859: 36 (unjustified emendation).  
*Nepticula arcuata*; Frey, 1857: 415—417; Stainton, 1858: 97; 1859: 434, 435; 1862: 196—203, pl. 9 fig. 3 (biology); Nolcken, 1871: 784—786.  
*Nepticula arcuatella*; Heinemann, 1862: 315, 316; Wocke, 1871: 338; 1874: 101; Heinemann & Wocke, 1877: 759; Meyrick, 1895: 723; Tutt, 1899: 306—308; Rebel, 1901: 226; Meess, 1910: 479; Meyrick, 1928: 860; Petersen, 1930: 70, fig. 96 (♂ genitalia); Klimesch, 1936: 208; Szöcs, 1965: 78.  
*Dechthiria arcuatella*; Beirne, 1945: 206, fig. 70 (♂ genitalia).  
*Stigmella arcuatella*; Klimesch, 1951: Gerasimov, 1952: 226; Klimesch, 1961: 759; Lhomme, 1963: 1194; Borkowski, 1969: 105, figs. 13, 14.  
*Stigmella (Dechthiria) arcuatella*; Hering, 1957: 42, 454, 821, fig. 503c (mine).  
*Trifurcula (Ectoedemia) arcuatella*; Johansson, 1971: 245.  
*Ectoedemia arcuatella*; Bradley et al., 1972: 2; Emmet, 1973: 180, 278 (differences with *rubivora*); Borkowski, 1975: 492; Emmet, 1976: 194, pl. 6 fig. 3, pl. 12 fig. 26; van Nieukerken, 1982: 108; Wilkinson et al., 1983: 211—224, figs. 5, 6, 11 (specific status).  
*Trifurcula arcuatella* (partim); Karsholt & Nielsen, 1976: 18.

Diagnosis: when not reared almost inseparable from *E. atricollis*, see diagnosis for that species. Females difficult to separate from *spinosella*.

#### Description.

Male (fig. 82). Forewing length 1.80—2.24 mm ( $2.11 \pm 0.17$ , 8), wingspan 4.0—4.9 mm. Head: frontal tuft yellow to ferruginous, mixed with fuscous scales, getting darker towards collar; collar fuscous to black. Antennae with 28—32 segments ( $29.9 \pm 1.5$ , 8). Hindwing with a white hair-pencil. Further as *angulifasciella*.

Female. Forewing length 1.64—2.32 mm ( $2.05 \pm 0.26$ , 10), wingspan 3.6—5.2 mm. An-

tennae with 24—28 segments ( $26.2 \pm 1.4$ , 9).

Male genitalia (figs. 136, 275, 323, 392). Capsule length 249—253  $\mu\text{m}$  (3). Gnathos fig. 323. Valva (fig. 275) length 180—189  $\mu\text{m}$  (4), inner margin almost straight, forming an obtuse angle with pointed tip. Aedeagus (fig. 392) 231—244  $\mu\text{m}$  (4), hardly constricted.

Female genitalia (figs. 215, 466). T8 with about 5 setae at each side. Anal papillae with 5—9 setae. Spiculate pouch with very few minute spines. Corpus bursae 420—500  $\mu\text{m}$ ; longest signum 227—313  $\mu\text{m}$  (4), shortest 206—283  $\mu\text{m}$  (4), 3.1—4.1  $\times$  as long as wide. Ductus spermathecae with 2½ convolutions.

Larva. Pale yellow, ganglia not very distinct. Head-capsule and prothoracic plate light brown. Penultimate instars with chain of brown ventral plates, which are shed in final instar.

#### Biology.

Hostplants. *Fragaria vesca* L., *F. moschata* Duchesne, *Potentilla erecta* (L.) Räuschel, *P. sterilis* (L.) Garcke.

Mine (fig. 506). Egg on leaf-underside. Early mine highly contorted gallery with brown, coiled frass; later widening into large irregular blotch with scattered brown frass.

Life history. Univoltine. Larvae from late August to middle of October. Adults emerge from end of May to July.

#### Distribution (fig. 534).

Widespread in Europe, but scarcer than the other three species of the complex. Only one record each from the Netherlands and France. Not yet recorded from Norway, Iberian Peninsula, Belgium or Ireland.

#### Remarks.

Frey discovered this species, named it *arcuata* and described it in 1856. However, Herrich-Schäffer, who renamed it *arcuatella* and attributed the species to Frey, described it one year ahead, and therefore is attributed with the authorship. Since Herrich-Schäffer clearly refers to the Frey material, it can be regarded as type material for both *arcuatella* and *arcuata*. The synonymy of *rubivora* with this species, as suggested by Borkowski (1975) has been refuted by Wilkinson et al. (1983).

Material examined: 29 ♂, 27 ♀. — Austria: 8 ♂, 6 ♀, 5 km. W. Völkermarkt: Pörschach (Kärnten), 500 m, e.l. 19.v—5.vi.1984, *Fragaria vesca*, J. J. Boomsma & E. J. van Nieukerken (ZMA); 1 ♂, 1 ♀, Wien,



Haschbg., e.l. 13, 20.v.1937, Preisseecker (NMW). — Denmark: 2 ♀, Bornholm, Gudhjem, e.l. 31.v—4.vi.1921, *Fragaria*, C. S. Larsen (ZMC). — Germany, West: 1 ♀, Braunschweig, Heinemann (RMNH); 2 ♂, Freiburg, iii.1882, *Fragaria*; 1 ♂, Wolfenbuttel, [Heinemann] (MHUB); 2 ♀, Pfalz, Eppelsheim (MHUB, NMW); 1 ♀, no data, 1870, Heinemann (MHUB); 1 ♂, locality illegible, *Frag. vesc.*, Heinemann (RMNH); 1 ♀, no data, 1878, Staudinger (NMW). — Germany, East: 1 ♂, Friedland, 11.iv.1889, Stange (NMW); 1 ♀, Kyffhausen, 12.vi.1912 (NMW); 2 ♀, Rachlau, Schütze (MHUB). — Greece: 1 ♂, Frangista (Evritanía), valley, 600 m, st. 29, e.l. 13—15.vi.1981, *Fragaria vesca*, Menken & Van Nieuwerkerken; 1 ♂, 1 ♀, 3 km SE Neráidha (Evritanía), 1200 m, st. 37, e.l. 3—4.vi.1981, *Fragaria vesca*, Menken & Van Nieuwerkerken (ZMA). — Netherlands: 1 ♂, 2 ♀, Woods W. of Wijlre, e.l. 3—9.vii.1982, E. J. van Nieuwerkerken (ZMA). — Poland: 1 ♀, Wrocław (Breslau), e.l. iv.1864, *Fragaria* (MHUB). — Switzerland: 1 ♂, 1 ♀ (lecto- and paralectotype), Zürich, Frey (BMNH). — USSR: 4 ♂, 2 ♀, Bendery (Tighina), Bessarabia, e.l. 16—18.v.1931, *Fragaria vesca*, Hering (MHUB). — Yugoslavia: 1 ♀, 2 km W. Otočac (Hrvatska), 450—500 m, e.l. 26—28.v.1984, *Fragaria vesca*, J. J. Boomsma & E. J. van Nieuwerkerken (ZMA).

Mines. — On *Fragaria vesca*. — Austria: Hof am Leithagebirge; Völkermarkt. — Great Britain: Churchill; Grays; Saffron Walden; Tintern. — Greece: Fournás, Evritanía; Frangista, Evritanía; Neráidha, Evritanía. — Italy: Tolmezzo. — Netherlands: Wijlre. — Yugoslavia: Han Knežica, N. of Prijedor; Otočac; Mt. Slavnik, S. of Herpelje-Kozina. On *Potentilla erecta*. — Italy: Tramonti di Sopra.

#### 46. *Ectoedemia* (*Ectoedemia*) *rubivora*

(Wocke, 1860)

(figs. 83, 135, 216, 276, 324, 393, 413, 467, 507, 535)

*Nepticula rubivora* Wocke, 1860, 132. Syntypes, Poland: Wrocław (Breslau), e.l. iv.18.. (ante 1860), Wocke (depository unknown) [not examined].

*Nepticula rubivora*; Heinemann, 1862: 315; Nolcken, 1871: 783; Wocke, 1871: 338; 1874: 101; Heinemann & Wocke, 1877: 783; Meyrick, 1895: 722, 723; Tutt, 1899: 310—313; Rebel, 1901: 226; Meess, 1910: 479; Sorhagen, 1922: 49, 50, pl. 3 fig. 52; Meyrick, 1928: 860; Petersen, 1930: 69, fig. 95 (♂ genitalia); Klimesch, 1936: 208; Szöcs, 1965: 76.

*Dechtria rubivora*; Beirne, 1945: 205, fig. 69 (♂ genitalia).

*Stigmella rubivora*; Klimesch, 1951: 62; Gerasimov, 1952: 257; Klimesch, 1961; 759; Lhomme, 1963: 1194; Borkowski, 1969: 112.

*Stigmella* (*Dechtria*) *rubivora*; Hering, 1957: 908, fig. 579a.

*Trifurcula* (*Ectoedemia*) *rubivora*; Johansson, 1971: 245.

*Ectoedemia rubivora*; Bradley et al., 1972: 2; Emmet, 1973: 180, 278 (differences with *arcuatella*); 1976: 195, pl. 6 fig. 7, pl. 12 fig. 27; Wilkinson et al., 1983: 211—224, figs. 7, 8, 12 (specific status).

*Ectoedemia arcuatella rubivora*; Borkowski, 1975: 492.

*Trifurcula arcuatella* (partim); Karsholt & Nielsen, 1976: 18.

Diagnosis: separated from the other Rosaceae mining *Ectoedemia* species by the black head in both sexes. In genitalia almost inseparable from *arcuatella*, although signa seem to have fewer cells.

#### Description.

Male (fig. 83). Forewing length 2.0—2.56 mm (2.28 ± 0.12, 25), wingspan 4.6—5.7 mm. Head: frontal tuft and collar black, sometimes with some fuscous scales. Antennae with 30—37 segments (33.2 ± 1.7, 19). Hindwing with white hair-pencil. Further as *angulifasciella*.

Female. Forewing length 2.08—2.69 (2.43 ± 0.18, 28), wingspan 4.6—6.0 mm. Antennae with 25—31 segments (27.9 ± 1.6, 24).

Male genitalia (figs. 135, 276, 324, 393, 413). Capsule length 257—283 μm (269.1 ± 9.8, 5). Gnathos fig. 324. Valva (fig. 276) length 176—206 μm (196.3 ± 11.9, 5), inner margin almost straight, forming an obtuse angle with pointed tip. Aedeagus (fig. 393) 236—266 μm (248.6 ± 12.5, 5), hardly constricted. Further as *angulifasciella*.

Female genitalia (figs. 216, 467). T8 with few setae at both sides. Anal papillae with 4—6 setae. Spiculate pouch with some almost invisible spines. Corpus bursae 410—460 μm; longest signum 227—274 μm (245.5 ± 17.1, 7), shortest 201—257 μm (226.5 ± 22.6, 7), 2.9—3.7 × as long as wide. Ductus spermathecae with 2½ convolutions.

Larva. Pale yellow, or yellowish white with green tinge, ganglia conspicuous. Head-capsule and prothoracic plate brown. Penultimate instars with chain of dark brown ventral plates and smaller, similar dorsal plates, which are shed in final instar.

#### Biology.

Hostplants. *Rubus fruticosus* L. (sensu lato), *R. caesius* L., *R. saxatilis* L., *R. chamaemorus* L. and *R. arcticus* L. (Kyarki & Tabell, 1984). Not found on *R. idaeus* L.

Mine (fig. 507). Egg on leaf-underside. Early mine highly contorted gallery filled with brown

frass; later widening into large irregular blotch with scattered black frass. Often staining surrounding tissue purple.

Life history. Univoltine. Larvae from late August until late October. Adults fly in June and July.

Distribution (fig. 535).

Widespread in Europe, from Lapland southwards to Central Italy. In the mediterranean region usually in river valleys and mountains only.

Remarks.

According to R. Puplesis (in litt.) no type material of this species is present in Wocke's collection in Leningrad, but from Wocke's very clear description and from subsequent Wocke material there can be no doubt about the identity of his species. Wilkinson et al. (1983) discussed the separate identity of *rubivora* and *arcuatella*.

Material examined: 62 ♂, 74 ♀. — Austria: 1 ♂, Linz, Au, 23.v.1923, Knitsche (NMW). — Denmark: 2 ♀, Faaborg (Fynen), Alliskus, e.l. 7—15.vi.1926, *Rubus*; 1 ♂, 4 ♀, Faaborg (Fynen), Sändarsjöen, e.l. 6—10.vi.1920, 17.vi.1922, 12—15.vi.1926, *Rubus* (ZMC). — Germany, West: 1 ♂, 2 ♀, Braunschweig, Heinemann (MHUB); 1 ♂, Hannover, Lederer (NMW); 1 ♂, Wolfenbuttel, [Heinemann] (MHUB). — Germany, East: 1 ♂, 5 ♀, Berlin-Finkenkrug, e.l. 6—12.vi.1930, *Rubus caesius*, Hering; 2 ♂, 2 ♀, Friedland, e.l. 4—10.iv.1888, *Rubus caesius*, Stange (MHUB); 2 ♂, idem, iv.1900 (NMW). — Great Britain: 1 ♂, 1 ♀, Saffron Walden (Essex), 3 km NE, e.l. 24.vi—4.vii.1980, Bryan, Emmet & Van Nieuwerkerken (ZMA). — Italy: 2 ♂, 1 ♀, 4 km WSW Tolmezzo (Udine), Villa Verzegnis, 550 m, e.l. 16—18.vi.1984, J. J. Boomsma & E. J. van Nieuwerkerken (ZMA). — Netherlands: 43 ♂, 41 ♀ from following localities: Blaricum, Gronsveld, Hulshorst, Kortenhof, Lunteren, Nunspeet, Simpelveld, Winterswijk (RMNH, ZMA). — Poland: 1 ♂, Silesia, Staudinger (RMNH); 1 ♀, Wrocław (Breslau), e.l. iv.1869, *Rubus caesius* (RMNH); 1 ♂, 5 ♀, Wrocław (Breslau), v.1862, [Wocke], *Rubus caesius* (MHUB). — Switzerland: 2 ♀, Glarus, e.l. 20.v., 7.vi.1875, *Rubus petraeus* (= *saxatilis*) (MHUB); 2 ♂, Zürich, coll. Lederer (MHUB); 1 ♀, no data, 1868 (NMW). — USSR: 1 ♂, Estonia, Nomme, Moor, *Rub. cham.*, Petersen (MHUB). — Yugoslavia: 2 ♀, Mt. Slavnik, 5 km S. Herpelje-Kozina (Slovenia), 800 m, e.l. 26.v—7.vi.1984, J. J. Boomsma & E. J. van Nieuwerkerken; 2 ♀, Sovinjak, 9 km NE Motovun (Hrvatska), Mirna valley, e.l. 8—15.vi.1984, J. J. Boomsma & E. J. van Nieuwerkerken (ZMA). — No Data: 1 ♂, e.l. vi, *Rubus caes.* (RMNH).

Mines. — Austria: Wien, Lobau. — Belgium: Zolder. — Germany, West: Gerolstein; Oberstadtfeld. — Great Britain: Cheddar Gorge; Grays; Hadleigh; Saffron Walden. — Italy: Tramonti di Sopra; Trento; Tolmezzo. — Netherlands: many localities. — Yugoslavia: NE Bihac; S. of Novska; Mt. Slavnik, S. of Herpelje-Kozina; Sovinjak, NE Motovun.

#### 47. *Ectoedemia* (*Ectoedemia*) *spinosella*

(de Joannis, 1908)

(figs. 18—20, 84, 137, 138, 217, 218, 277, 325, 395, 468, 508, 509, 536)

*Nepticula spinosella* J. de Joannis, 1908a: 328. Lectotype ♀ (here designated), France: Vannes, 18.vi., prunetier, L. de Joannis, Genitalia slide VU 947 (MNHN) [examined].

*Nepticula spinosella*; J. de Joannis, 1908b: 825, 826, fig. 3, pl. 15 fig. 13 (larva, mine, adult); Klimesch, 1936: 206; 1941: 163, 164, pl. 16 fig. 5 (♂ genitalia); Szöcs, 1965: 78.

*Stigmella spinosella*; Klimesch, 1951: 62; Gerasimov, 1952: 260; Hering, 1957: 835, fig. 518 (mine); Klimesch, 1961: 759; Lhomme, 1963: 1194; Emmet, 1970b: 121, 122, fig. 1.

*Dechthiria spinosella*; Emmet, 1971: 244.

*Trifurcula* (*Ectoedemia*) *spinosella*; Johansson, 1971: 245.

*Ectoedemia spinosella*; Bradley et al., 1972: 2; Emmet, 1974a: 79, 80; Borkowski, 1975: 493; Emmet, 1976: 192, pl. 6 fig. 8, pl. 12 fig. 23; van Nieuwerkerken, 1982: 108, fig. 8 (mine).

Diagnosis: *E. spinosella* is externally similar to the *angulifasciella* complex, but is smaller, has a fuscous collar and the male has a brown hair-pencil surrounded by some brown lamellar scales. The female can be separated from *atricollis* by shorter signa with smoother, more uniformly curved outline. See for separation from *mahalebella* under that species.

#### Description.

Male (fig. 84). Forewing length 1.44—2.20 mm ( $1.87 \pm 0.15$ , 29), wingspan 3.2—4.9 mm. Head: frontal tuft orange to orange fuscous, sometimes completely fuscous; collar fuscous. Antenna with 24—30 segments ( $26.8 \pm 1.7$ , 18). Thorax and forewings blackish fuscous with medial silvery fascia, slightly concave at inner margin. Hindwing with brown hair-pencil, surrounded by a small patch of brown, lamellar scales. Underside of forewing with a tuft of long grey or white hairscales, arising near costal retinaculum.

Female. Forewing length 1.52—2.24 mm ( $1.85 \pm 0.16$ , 34), wingspan 3.4—5.0. Antennae with 21—26 segments ( $22.5 \pm 1.1$ , 29). Hind-



wing without brown patch, forewing without tuft.

Male genitalia (figs. 137, 138, 277, 325, 395). Capsule length 193—219  $\mu\text{m}$  ( $207.9 \pm 8.9$ , 8). Tegumen produced into broad and truncate pseuduncus. Gnathos (fig. 325) divided, with short, rounded distal element, and basal part with serrate margin. Valva (fig. 277) length 133—150  $\mu\text{m}$  ( $142.5 \pm 5.5$ , 8), inner margin slightly sinuous to almost straight, tip pointed. Aedeagus (fig. 395) 231—253  $\mu\text{m}$  ( $242.1 \pm 7.6$ , 8), with single, or bifid, pointed carinae.

Female genitalia (figs. 217, 218, 468). T7 without a row of setae. T8 with two lateral patches of scales and several setae (at least 4). Anal papillae with 6—11 setae. Vestibulum with incomplete vaginal sclerite, a spiculate pouch with indistinct spines. Corpus bursae 440—550  $\mu\text{m}$ , completely covered with small pectinations or minute spines; signa slightly dissimilar, ovoid, with smooth, uniformly curved outline, longest 249—373  $\mu\text{m}$  ( $312.4 \pm 44.6$ , 9) shortest 227—330  $\mu\text{m}$  ( $283.3 \pm 35.4$ , 9), 2.4—3.5  $\times$  as long as wide. Ductus spermathecae with 2—2 $\frac{1}{2}$  convolutions.

Larva. Greenish white, with distinct brown ganglia. Head light brown. Ventral plates absent.

#### Biology.

Hostplants. *Prunus* spp., in central and northern Europe only on *P. spinosa* L., in the south also recorded from *P. domestica* L., *P. cerasifera* Ehrh., *P. fruticosa* Pallas (to be confirmed), *P. dulcis* (Miller) (Greece).

Mine (figs. 508, 509). Egg on leaf underside, close to mid-rib, or less often lateral vein; occasionally on leaf-margin. Early mine much contorted narrow gallery, filled with reddish frass, later becoming elongate blotch with dispersed black frass, often very compact.

Life history. Univoltine. Larvae from end of July to October, most abundant in September, but in southern Greece some mines were vacated already by mid June. Adults in June and July (occasionally May).

#### Distribution (fig. 536).

Widespread in central Europe, but more localised northwards, occurring mainly on sun-exposed hills, or near coast (in England). Probably widespread in mediterranean area, but not yet recorded from Iberian Peninsula, the mediterranean islands, and most of the Balkan. Borkowski (1975) did not mention *E. spinosella*

from Poland, but the specimens cited below, collected by Hering, indicate its presence in Poland. Recently Buszko (in litt.) found it also in Poland.

#### Remarks.

Before De Joannis discovered this species in France, it had been mistaken several times for *E. atricollis*. Named as such, specimens which were collected by Eppelsheim in Pfalz can be found in many collections. To my knowledge *E. atricollis* has never been found on *Prunus spinosa*.

Greek specimens reared from *Prunus dulcis* (on which it is locally almost a pest) differ slightly in head-colour and female signa (usually shorter), but electrophoretically they appeared to be indistinguishable from normal *spinosella* (Menken, in preparation).

Material examined: 52  $\sigma$ , 59  $\varphi$ . — Austria: 1  $\sigma$ , Dürnstein, e.l. 2.vi.1936, J. Klimesch; 1  $\varphi$ , Klosterneuburg, Freiberg, e.l. 15.vi.1941, Preissecker; 2  $\sigma$ , 1  $\varphi$ , Mödling, e.l. 7—25.v.1938, Preissecker; 1  $\sigma$ , Neu-Aigen, Schmidawiesen, e.l. 18.v.1937, Preissecker (NMW). — France: 3  $\sigma$ , 4  $\varphi$  (lecto- and paralecto-types), Vannes, 18.vi, 2.vii, prunetier (= *Prunus spinosa*), Joannis (MNHN). — Germany, West: 2  $\varphi$ , Grünstadt, Pfalz, Eppelsheim (MHUB, NMW); 3  $\varphi$ , Pfalz, e.l. 1893, 1894, *Prunus spinosa*, Eppelsheim (MHUB, NMW); 3  $\sigma$ , no data (probably Pfalz, Eppelsheim) (ZMA); 1  $\sigma$ , 2  $\varphi$ , Lemberg-Zuffh., Württemberg, e.l. 5—10.v.1939, *Prunus spinosa*, A. Wörz (LNK, coll. Johansson). — Great Britain: 1  $\varphi$ , Puddle Dock (Essex), e.l. 4.vi.1982, *Prunus spinosa*, A. M. Emmet (ZMA). — Greece: 31  $\sigma$ , 25  $\varphi$ , Arákhova (Voiotía), 950 m, e.l. 2.v.—8.vii.1981, *Prunus dulcis*, 27—29.ix.1980, S. B. J. Menken, E. J. van Nieukerken (ZMA, ZSMK). — Hungary: 1  $\sigma$ , Badacsony, e.l. 10.vi.1969, *Prunus spinosa*, J. Szócs; 1  $\sigma$ , 3  $\varphi$ , Törökbálint (W. of Budapest), e.l. 20.vi—16.vii.1955, *Prunus spinosa*, J. Szócs (TMAB). — Netherlands: 3  $\sigma$ , 5  $\varphi$ , Gulpen, e.l. 7—16.vi.1980, *Prunus spinosa*, E. J. van Nieukerken; 1  $\sigma$ , 1  $\varphi$ , 2 km NE Wijlre, Vrakelberg, e.l. 11—13.vi.1980, *Prunus spinosa*, E. J. van Nieukerken; 3  $\sigma$ , 9  $\varphi$ , Woods W. of Wijlre e.l. 22.vi—6.vii.1982, *Prunus spinosa*, Alders, Van Nieukerken (ZMA). — Poland: 1  $\sigma$ , 2  $\varphi$ , Krosna Odr. (Crossen a. Oder), e.l. 7—12.vi.1930, *Prunus spinosa*, Hering (MHUB).

Mines. — On *Prunus spinosa*. — Austria: Gumpoldskirchen. — France: Villefranche-de-Confient. — Germany, West: Kassel, 1.x.1946 (BMNH); Klotten. — Netherlands: Gulpen; Wijlre. — Poland: Bellinchen/Oder, W. of Chojna, 6.ix.1939, Hering; Krosna Odr. (Crossen/Oder), ix.1929, Hering (BMNH). — Yugoslavia: Savudrija (Istria). On *Prunus dulcis*. — Greece: Arakhova; Dhelfoi; Kardhamili.



48. *Ectoedemia* (*Ectoedemia*) *mahalebella*  
(Klimesch, 1936)

(figs. 85, 140, 141, 219, 278, 326, 396, 469, 510, 537)

*Nepticula mahalebella* Klimesch, 1936: 207, 208, figs. 8, 9. Syntypes, Italy: Naturno, Vintschgau, e.l. 5—21.v. 1935, *Prunus mahaleb*, J. Klimesch (ZSMK) [not examined].

*Nepticula mahalebella*; Klimesch, 1940b: 190; Szócs, 1965: 79.

*Stigmella mahalebella*; Lhomme, 1945: 155; Klimesch, 1948: 72, figs. 47—49 (♂ genitalia); 1951: 62; 1961: 759; Lhomme, 1963: 1195.

*Nepticula* (*Dechtiaria*) *mahalebella*; Klimesch, 1950: 28, figs. 13—15 (mine, ♂ genitalia, foodplant races).

*Stigmella* (*Dechtiaria*) *mahalebella*; Hering, 1957: 836 (mine).

*Ectoedemia mahalebella*; Szócs, 1978: 266.

Diagnosis: easily separated from related *spinosella* by light collar, which is concolorous with frontal tuft (darker in *spinosella*), and absence of hair-pencil and special scales on hindwing of male, and by position and shape of signa in female genitalia. Similar, but larger, *angulifasciella* separated by presence of hair-pencil and different shape of valva in male and signa in female. See also diagnosis of *hexapetalae*.

Description.

Male (fig. 85). Forewing length 1.92—2.40 mm ( $2.14 \pm 0.17$ , 7), wingspan 4.3—5.3 mm. Head: frontal tuft yellowish orange to ferruginous; collar concolorous with or lighter than frontal tuft. Antennae with 26—32 segments ( $28.7 \pm 1.9$ , 7). Thorax and forewings blackish fuscous with medial silvery fascia, inner margin slightly concave. Hindwing without hair-pencil or costal bristles. Underside forewing with a tuft of long grey hair-scales, arising near costal retinaculum.

Female. Forewing length 2.0—2.36 mm ( $2.15 \pm 0.10$ , 14), wingspan 4.4—5.2 mm. Antennae with 23—27 segments ( $24.5 \pm 1.2$ , 11).

Male genitalia (figs. 140, 141, 278, 326, 396). Capsule length 201—214  $\mu$ m (4). Tegumen produced into broad and truncate pseuduncus. Gnathos (fig. 326) divided into short, rounded distal part, and basal part with serrate margin. Valva (fig. 278) length 129—150  $\mu$ m (4), inner margin straight, tip pointed; valva widest at base, constricted below tip. Aedeagus (fig. 396) 231—274  $\mu$ m ( $260.6 \pm 17.0$ , 5), with single or bifid, pointed carinae.

Female genitalia (figs. 219, 220, 469). T7

without a row of setae. T8 with two lateral patches of scales and 6—8 setae. Anal papillae with 5—11 setae. Vestibulum with complete vaginal sclerite, a spiculate pouch with indistinct spines. Corpus bursae long, 570—715  $\mu$ m, proximally covered with pectinations, distally with small spines; signa ovoid, almost similar, confined to proximal (posterior) half of corpus bursae, length 201—304  $\mu$ m ( $238.9 \pm 26.3$ , 19),  $1.8—2.4 \times$  as long as wide. Ductus spermathecae with  $2\frac{1}{2}$ —3 convolutions.

Larva. Greenish white, with distinct brown ganglia. Head light brown. Ventral plates absent.

Biology.

Hostplants. *Prunus mahaleb* L., on which most common, *P. cocomilia* Ten. (Greece), *P. tenella* Batsch (Hungary), *P. fruticosa* Pallas, *P. avium* L. and *P. cerasus* L. (Klimesch, 1950 and own data).

Mine (fig. 510). Egg deposited on leaf-underside, usually at or near margin, in French and Yugoslavian samples 99% at margin, but in Italian and Greek samples up to 50% close to midrib or lateral vein. It is not yet clear if these mines belong all to *mahalebella*. Early gallery narrow, following leaf margin, or much contorted, filled with reddish frass; later abruptly changing into small roundish blotch, with blackish frass accumulated in centre.

Life history. Univoltine. Larvae from late July until mid-October. Adults in May and June (rearing data).

Distribution (fig. 537).

A southern European species, south and east of the Alps, including hot alpine valleys. Recorded from Rumania as *E. spinosella* (Draghia, 1967).

Remarks.

The types have not been examined, but from Klimesch's (1936) description, the identity of this species is clear.

In central Europe *E. mahalebella* and *spinosella* are clearly separated by their host-plants, but in the south, they could have overlapping hostplant ranges. More data are needed to confirm this.

Material examined: 12 ♂, 19 ♀. — Austria: 2 ♀, Bad Deutsch Altenburg, Pfaffenberg, e.l. 4 + 23.vi.1934, Weichsel (= *P. mahaleb*), Preissecker (NMW). — France: 1 ♂, 1 ♀, St. Thibaud-de-Couz

(Savoie), 500—700 m, e.l. 11—19.vi.1980, *Prunus mahaleb*, E. J. van Nieukerken (ZMA). — Greece: 1 ♀, Parnassós Oros, NW Arákhova (Voioitia), plateau, 1150 m, e.l. 9—11.v.1981, *Prunus cocomilia*, S. B. J. Menken & E. J. van Nieukerken; 2 ♂ 5 ♀, Mt. Timfristós (Evrítania) above Karpenísson, 1200—1400 m, e.l. 21.v—25.vi.1981, *Prunus cocomilia* and *P. mahaleb*, S. B. J. Menken & E. J. van Nieukerken (ZMA). — Hungary: 3 ♀, Budaörs, e.l. 3—7.vi.1971, *Prunus mahaleb*, J. Szócs; 3 ♂, Budaörs, Csiki-hegyek, e.l. 20—27.vi.1962, *Prunus mahaleb*, J. Szócs; 1 ♀, Budaörs, Útegy, e.l. 14.vi.1973, *Prunus tenella*, J. Szócs (TMAB). — Italy: 1 ♂, 1 ♀, Trento, Goccladoro, e.l. iv.1946, *Prunus mahaleb*, J. Klimesch (ZMA). — Yugoslavia: 5 ♂, 5 ♀, Selce, 4 km SE Crikvenica (Hrvatska), a.s.l., mines 15.x.1983, e.l. 30.iv—3.v.1984, *Prunus mahaleb*, J. J. Boomsma & E. J. van Nieukerken (ZMA).

Mines. — On *Prunus avium*. — Italy: Guillian near Savona, 17.ix.1944, J. Klimesch (BMNH); Frascati, 17.xii.1941, Groschke (BMNH). On *Prunus cocomilia*. — Greece: Oíti Oros, SW Ipáti (Fthiótis); Oíti Oros, NE Strómi (Fokís); Mt. Timfristós above Karpenísson; Parnassós Oros, NW Arákhova (Voioitia). On *P. fruticosa*. — Austria: Hundsheimer Berg near Hainburg. On *P. mahaleb* — Austria: Hainburger Berge (BMNH). — France: St. Thibaud-de-Couz (Savoie); Modane (Savoie); Villefranche-de-Conflent (Pyr. Or.). — Greece: Mt. Timfristós above Karpenísson; Kastráki (Tríkala). — Italy: Avezzano (Lazio); Brenzone, x.1943, Groschke (BMNH); Susa, Piemonte, 20.viii.1960, 1.ix.1964, Jäckh (BMNH). — Yugoslavia: Crikvenica (Croatia); Novi Vinodolski (Croatia).

#### The *Ectoedemia occultella* group

This group comprises two closely related species, mining in Betulaceae. They differ from all other described *Ectoedemia* s.str. species by the absence of a cilia-line and the concolorous black cilia. See further the descriptions.

The larvae are yellow and possess ventral plates. This group occurs also in North America (*E. lindquisti* (Freeman)) and in Japan.

#### 49. *Ectoedemia* (*Ectoedemia*) *occultella*

(Linnaeus, 1767)

(figs. 4, 5, 86, 87, 139, 221, 279, 397, 405, 470, 511, 512, 530)

*Phalaena* (*Tinea*) *occultella* Linnaeus, 1767: 899. Syntypes, Sweden: Hammerby, Linnaeus (depository unknown, probably lost) [not examined].

*Tinea strigilella* Thunberg, 1794: 87. Lectotype ♀ (designated by Robinson & Nielsen, 1983), Sweden: [Uppsala], Gedner, Genitalia slide RJ 751A (Zoological Institute, Uppsala) [not examined] [Synonymised by Robinson & Nielsen, 1983].

? *Tinea mucidella* Hübner, [1814—1817]: pl. 65 fig.

435. Syntypes, [Europe] (depository unknown [not examined]).

*Tinea mediofasciella* Haworth, 1828: 584. Lectotype ♂ (here designated), [England: London], ex Haworth coll., Stainton coll., Genitalia slide 22608 (BMNH) [examined]. **Syn. nov.**

*Lyonetia argentipedella* Zeller, 1839: 215. Lectotype ♀ (here designated) [Poland: Głogów (Glogau)], 28.v.[18]35, Zeller, Walsingham coll. 1910—427, 101267, Genitalia slide 22600 (BMNH) [examined]. [Synonymised by Robinson & Nielsen, 1983].

*Lyonetia argentipedella*; Tengström, 1848: 152.

*Nepticula argentipedella*; Heyden, 1843: 208; Zeller, 1848: 316, 317; Stainton, 1849: 29; 1854: 303; Herrich-Schäffer, 1855: 353; Frey, 1856: 386, 387; 1857: 421, 422; Stainton, 1859: 435; 1862: 212—219, pl. 10 fig. 2; Heinemann, 1871: 218; Nolcken, 1871: 780; Wocke, 1871: 338; 1874: 101; Heinemann & Wocke, 1877: 754, 755; Snellen, 1882: 996, 997; Sorhagen 1886: 307; Meyrick, 1895: 721; Tutt, 1899: 289—291; Rebel, 1901: 225; Meess, 1910: 478, pl. 91 fig. 66; Sorhagen, 1922: 48, pl. 2 fig. 46; Meyrick, 1928: 858; Petersen, 1930: 66, fig. 82 (♂ genitalia); Szócs, 1965: 64.

[no genus] *argentipedella*; Herrich-Schäffer, [1853]: pl. 105, fig. 834.

*Dechtria argentipedella*; Beirne, 1945: 205, fig. 62 (♂ genitalia).

*Stigmella argentipedella*; Klimesch, 1951: 61; Gerasimov, 1952: 226; Klimesch, 1961: 758; Lhomme, 1963: 1188.

*Stigmella* (*Dechtria*) *argentipedella*; Hering, 1957: 179, fig. 124 (mine).

*Nepticula* (*Dechtria*) *argentipedella*; Szócs, 1968: 226 (biology).

*Trifurcula* (*Ectoedemia*) *argentipedella*; Johansson, 1971: 245.

*Ectoedemia argentipedella*; Bradley et al., 1972: 2; Borkowski, 1975: 493; Emmet, 1976: 197, pl. 6 fig. 9, pl. 12 fig. 28; van Frankenhuyzen & de Vries, 1979: 129—135, figs. (biology).

*Trifurcula argentipedella*; Karsholt & Nielsen, 1976: 18.

*Microsetia mediofasciella*; Stephens, 1829: 208; 1834: 268.

? *Elachista mucidella*; Treitschke, 1833: 179.

*Ectoedemia occultella*; Robinson & Nielsen, 1983: 221, 222.

Diagnosis: easily distinguished from other *Ectoedemia* spp. (except *minimella*), by completely jet-black colour of thorax and forewings, (except fascia), including cilia, and absence of cilia-line. Separated from *Stigmella* species by medial fascia (usually postmedial in *Stigmella*) and collar, consisting of hair-scales, instead of lamellar scales as in *Stigmella*. Separated from very similar *minimella* by presence of group of



white scales on underside of forewing in male, and by light coloured head in female. See also *minimella*.

#### Description.

Male (fig. 86). Forewing length 2.36—3.44 mm ( $2.85 \pm 0.33$ , 23), wingspan 5.1—7.5 mm. Head: frontal tuft black, often mixed with some fuscous or ochreous scales; collar black. Antennae with 31—42 segments ( $35.6 \pm 2.9$ , 19). Thorax and forewings completely jet-black, less coarsely scaled than in other *Ectoedemia* species, with a rather broad, almost straight dull white fascia, sometimes slightly constricted in middle. Hindwing with a relatively long white hair-pencil. Underside forewing with a small elongate patch along costa with narrow white scales, often difficult to see.

Female (fig. 87). Forewing length 2.56—3.84 mm ( $3.28 \pm 0.39$ , 20), wingspan 5.7—8.4 mm. Head: frontal tuft yellowish to yellowish orange, sometimes mixed fuscous; collar yellow. Antennae with 27—32 segments ( $29.4 \pm 1.6$ ). Patch of white scales on underside forewing absent.

Male genitalia (figs. 139, 279, 397, 405). Cap-sule length 313—390  $\mu\text{m}$  ( $353.6 \pm 27.4$ , 10), very large comparing with other *Ectoedemia* (s.s.) species. Tegumen produced into long tapering, pointed pseuduncus. Gnathos (fig. 327) with relatively broad, blunt central element. Valva (fig. 279) length 236—279  $\mu\text{m}$  ( $245 \pm 8.3$ , 6), outer margin strongly convex, inner margin slightly concave, almost straight; tip pointed, pointing posteriorly. Aedeagus (figs. 397, 405) 304—351  $\mu\text{m}$  ( $326.8 \pm 17.5$ , 12), carinae each divided into several blunt ending digitate processes, number variable; vesica with many small, triangular cornuti only.

Female genitalia (figs. 221, 470). T7 without row of setae. T8 with two groups of scales and 3—5 setae. Anal papillae confluent, in total with 18 to 40 setae. Vestibulum with vaginal sclerite, and a dorsal spiculate pouch with very few minute spines only. Corpus bursae 495—580  $\mu\text{m}$ , with pectinations closely set in two lateral bands, at some distance from signa; signa dissimilar, one reaching vestibulum, longest 214—334  $\mu\text{m}$  ( $275.3 \pm 34.1$ , 9), shortest 180—266  $\mu\text{m}$  ( $221.0 \pm 27.9$ , 9), 2.2—3.3  $\times$  as long as wide. Ductus spermathecae with 2½—3 convolutions.

Larva. Pale yellowish white, ganglia not very conspicuous. Head light brown. Penultimate stages with 12 black ventral plates.

#### Biology.

Hostplants. *Betula* spp. Occurring on all native *Betula* spp. in Europe and many species in botanical gardens (Buhr, 1935, Van Frankenhuyzen & De Vries, 1979). In northern Finland it has been found mining both on *Salix pentandra* L. and *Betula*, but no adults have yet been reared from *Salix* (J. Kyrki, pers. comm.).

Mine (figs. 511, 512). Egg on leaf underside, rarely on upper side. Mine large blotch, often almost circular, with black circular blotch in middle, caused by staining of both epidermis layers; frass black, irregular, but usually accumulated under and near blotch. Mine does not start as gallery, young mines consist of black blotch only, through which larva cannot be seen.

Life history. Univoltine. Larvae feed slowly during long period, from the end of June to early November. Complete mines with mature larvae can occasionally be found from late July to August, but are most common in September and October. Adults fly in May and June. See detailed description by Van Frankenhuyzen & De Vries (1979).

#### Distribution (fig. 530).

One of the commonest and most widespread *Ectoedemia* species in Europe, occurs in almost all places where birch grows. In southern Europe probably in mountains only, and recorded from Etna, Sicily.

#### Remarks.

This species has long been known as *E. argentedella* (Zeller), but Robinson & Nielsen (1983) showed that this is a junior synonym of *occultella* Linnaeus.

The type series of *Tinea mediofasciella* Haworth comprises five specimens, representing several species, including *Bucculatrix*, *Stigmella*, and one *Ectoedemia*. *E. mediofasciella* was previously incorrectly synonymised with *woolhopiella* Stainton (= *minimella*), probably on the basis of the single *Ectoedemia* specimen, selected here as lectotype. Examination of the genitalia, which had not earlier been dissected, however, showed it to be *occultella*.

The identity of *Tinea mucidella* Hübner is still unknown, this synonymy has been suggested by Zeller (1839) in his description of *argentedella*.

*E. lindquisti* (Freeman, 1962), described also by Wilkinson & Scoble (1979) and Wilkinson & Newton (1981) is extremely similar to *occultella* in the adult and larval stage and in its life history



(Lindquist, 1962). The only difference seems to be the absence of a patch of white scales on the underside of the forewing of the males. The allozyme differences are also small (Menken, in preparation), so it is probable that *lindquisti* and *occultella* are vicariant forms, and hence different subspecies.

Material examined: 102 ♂, 88 ♀, 141 ex. — Austria: 1 ♀, no further data (RMNH). — France: 3 ♂, 1 ♀, Pralognan (Savoie), 1450 m, e.l. 21—23.v.1980, E. J. van Nieukerken (ZMA). — Germany, West: 1 ♂, 1 ♀, Alendorf, 8 km S. of Blankenheim (N.-Westf.), e.l. 10—18.v.1983, Alders & Van Nieukerken (ZMA); 1 ♀, Stuttgart (MHUB). — Germany, East: 1 ♀, Berlin, Bot. Garten, 12.v.1947, Hering; 2 ♂, 1 ♀, Berlin Finckenkrug, 1918—1932, Hering; 1 ♀, Berlin Frohnau, 18.ii.1920, Hering; 3 ♂, 6 ♀, Potsdam, 13.iv.1886, 15—20.v.1898, Hinneberg; 1 ex., Rachlau, 1884, Schütze (MHUB). — Great Britain: 1 ♂, 5 ♀, Bromley (London), 7—11.v.1939, S. Jacobs (ZMA); 1 ♂ (lectotype of *mediofasciella*, see above). — Netherlands: 82 ♂, 61 ♀, 140 ex. from following localities: Arnhem; Epen; Geulhem; 's-Gravenhage; Hilversum; Hoge Veluwe; Kerkrade; Kortenhoef; Kortenhoefse Plassen; Kosberg; Loosduinen; Meijnweg; Neerbosch; Nunspeet; Rockanje; Schin op Geul; Schinveld; Slenaken; Wageningen; Wijlre; Winterswijk; Zwanewater (RMNH, ZMA, AFW, coll. Huisman, coll. Kuchlein). — Poland: 1 ♀ (lectotype of *argentipedella*, see above); 2 ♀, Obernigk, ii.1869; 1 ♂, 2 ♀, Wrocław (Breslau), ii.1869, Wocke (MHUB). — Switzerland: 1 ♂, 2 ♀, Zürich (MHUB). — No Locality Data: 5 ♂, 2 ♀ (ZMA, RMNH, MHUB).

Material of *lindquisti* examined. — Canada: 6 ♂, 3 ♀, Ontario: Awenda Prov. Park, Penetang, Simcoe Co., mines 24.viii.1981, *Betula papyrifera*, Evans, e.l. 2—8.vi.1982 (ZMA); USA: 2 ♂, 1 ♀, Maine, Bethel, 29.vi.1946, A. F. Braun (USNM).

Mines. — Austria: Gramatneusiedl; Hermagor; Mühlleiten; Lavamünd. — Belgium: Bolderberg, Zolder. — France: Le Hohwald; Pralognan. — Germany, West: Alendorf; Oberstadtelf. — Great Britain: Brentwood; Grays; New Forest. — Hungary: Budapest. — Italy: Naturno; Tolmezzo; Trento. — Netherlands: many localities. — Yugoslavia: Fužine, SW Delnice.

### 50. *Ectoedemia (Ectoedemia) minimella*

(Zetterstedt, 1839) comb. n.

(figs. 88, 142, 222, 280, 328, 398, 406, 414, 415, 513, 531)

*Elachista minimella* Zetterstedt, 1839: 1011. Lectotype ♀ (here designated), Norway: Nordland, Björkvik, 14.vii, Zetterstedt, Genitalia slide RJ (Zoological Institute, Lund, Sweden) [examined by R. Johansson].

*Nepticula woolhopiella* Stainton, 1887: 262. Lectotype ♀ (here designated), Great Britain: Tarring-

ton, 29.vi.1887, e.l. birch, Wood, Genitalia slide 11362 (BMNH) [examined]. **Syn. nov.**

*Nepticula viridicola* Weber, 1937: 211, 212, fig. 1. Lectotype ♂ (here designated), Switzerland: Simplon, 1970 m, mines 19.ix.1936, *Alnus virid.*, Z. 2606, Weber, Genitalia slide ETH 1241 (ETHZ) [examined]. **Syn. nov.**

*Nepticula argentipedella* [partim]; Meyrick, 1895: 721.

*Nepticula woolhopiella*; Tutt, 1899: 292, 293; Rebel, 1901: 225; Meess, 1910: 478; Meyrick, 1928: 858; Petersen, 1930: 67.

*Dechtria woolhopiella*; Beirne, 1945: 205, fig. 63 (♂ genitalia).

*Stigmella woolhopiella*; Gerasimov, 1952: 270; Klimesch, 1961: 758; Borkowski, 1969: 100.

*Stigmella (Dechtria) woolhopiella*; Hering, 1957: 181, fig. 118b (mine).

*Trifurcula (Ectoedemia) woolhopiella*; Johansson, 1971: 245.

*Ectoedemia woolhopiella*; Borkowski, 1975: 493.

*Stigmella viridicola*; Klimesch, 1948: 70, figs. 43, 44 (♂ genitalia); 1951: 61; Hering, 1957: 66, fig. 37a (mine); Klimesch, 1961: 758.

*Ectoedemia woolhopiella viridicola*; Borkowski, 1975: 494.

[*Ectoedemia mediofasciella*; Bradley et al., 1972: 2; Emmet, 1973: 282, 283; 1976: 197, pl. 6 fig. 12; pl. 12 fig. 29; Van Nieukerken, 1982: 107, 108, fig. 7 (mine). misidentification].

[*Trifurcula mediofasciella*; Karsholt & Nielsen, 1976: 18. misidentification].

Diagnosis: extremely similar to *occultella*, for external differences see under that species. Male genitalia can be separated by smaller size, presence of large elongate cornuti and shape of gnathos. Female genitalia extremely difficult to separate, but *minimella* has usually shorter and wider signa, although there is some overlap.

### Description.

Male (fig. 88). Forewing length 2.32—2.72 mm ( $2.54 \pm 0.11$ , 14), wingspan 5.1—6.1 mm. Head: frontal tuft black; collar black. Antennae with 35—42 segments ( $37.5 \pm 2.2$ , 14). Thorax and forewings completely jet-black, less coarsely scaled than in other *Ectoedemia* species, with a rather broad, almost straight, dull white fascia, sometimes slightly constricted in middle. Hindwing with a greyish hair-pencil, slightly shorter than *occultella*. Underside of forewing without white scale patch.

Female. Forewing length 2.28—3.04 mm ( $2.71 \pm 0.24$ , 16), wingspan 5.1—6.6 mm. Head: frontal tuft black, or mixed with yellow and fuscous scales, sometimes completely yellow on frons, but always black on vertex; collar

black. Antennae with 23—29 segments ( $26.3 \pm 1.9, 14$ ).

Male genitalia (figs. 142, 280, 328, 398, 406, 414, 415). Capsule length 296—321  $\mu\text{m}$  ( $307.9 \pm 11.6, 6$ ). Tegumen (figs. 414, 415) produced into long tapering, pointed pseuduncus. Gnathos (fig. 328) with narrow, truncate central element. Valva (fig. 280) length 214—227  $\mu\text{m}$  ( $221.0 \pm 4.2, 7$ ), outer margin strongly convex, inner margin slightly concave, almost straight; tip pointed, pointing posteriorly. Aedeagus (figs. 398, 406) 283—309  $\mu\text{m}$  ( $297.1 \pm 10.0, 6$ ), carinae each divided into several blunt ending processes, number variable; vesica with about 20—22 long, needle shaped cornuti at right side, and many smaller cornuti in remaining part of vesica.

Female genitalia (figs. 222, 471). T7 without row of setae. T8 with two groups of scales and about 4 setae. Anal papillae confluent, with 23—32 setae in total. Vestibulum with vaginal sclerite, and dorsal spiculate pouch with very few minute spines only. Corpus bursae 440—550  $\mu\text{m}$ , with pectinations in two lateral bands, at some distance from signa; signa dissimilar, longest 176—279  $\mu\text{m}$  ( $240 \pm 37.4, 7$ ), shortest 167—231  $\mu\text{m}$  ( $199.6 \pm 24.9, 7$ ),  $2.0\text{--}2.4 \times$  as long as wide. Ductus spermathecae with  $2\frac{1}{2}$ —3 convolutions.

Larva. Pale yellow to yellowish white, with distinct brown ganglia. Head light brown. Penultimate instars with 12 black ventral plates.

#### Biology.

Hostplants. *Betula* spp., usually on *B. pubescens* Ehrh., or in Scandinavia *B. nana* L., less common on *B. pendula* Roth. In the Alps common on *Alnus viridis* (Chaix) DC. in Lam. & DC., which it seems to prefer even in the presence of *Betula*. In the west of Great Britain also recorded from *Corylus avellana* L.

Mine (fig. 513). Egg deposited on leaf underside. Early mine much contorted gallery, with dispersed frass, staining leaf brown; later abruptly enlarges into elongate blotch, which often fills the space between two veins; dispersed black frass.

Life history. Univoltine. Larvae found from July to September, occasionally October in south, but most abundant in August and early September. Adults fly in May and June.

#### Distribution (fig. 531).

Common and widespread in Scandinavia and locally in the Alps, but elsewhere very local and

always less common than *occultella*. Not yet recorded from Belgium, Spain (to be expected in Pyrenees) or Yugoslavia (Alps).

#### Remarks.

This species has been known since 1972 (Bradley et al.) under the name *E. mediofasciella*, but this was apparently based on a misinterpretation of the type, which in fact belongs to *occultella*.

The first available name appears now to be *minimella* Zetterstedt, a name of which the identity was hitherto unknown. The two specimens mentioned by Zetterstedt (1839) are both in Lund, and were examined by R. Johansson, who kindly communicated us his observations. The specimen labelled "*minimella* ♀" is identical with *woolhopiella*, and selected as lectotype. The other specimen, described as variety, is a female of *E. (Fomoria) weaveri* (Stainton).

There seem to be no grounds for regarding *viridicola* as a subspecies (Borkowski, 1975), since it is not geographically or morphologically separate, and shows no differences in allozyme pattern (Menken, in preparation). The fact that it often feeds only on *Alnus*, even in the presence of *Betula* might be explained by the oviposition preference of females, which they cannot follow in other parts of its range where *Alnus viridis* is absent. It would be interesting to study *minimella* populations — if present — in northern Siberia or Corsica, where other subspecies of *A. viridis* occur.

The character given by Beirne (1945) to separate *minimella* from *occultella* is incorrect and probably based on an artifact. It is questionable if the genitalia, depicted by him, belong to *minimella*, since he did not figure the characteristic cornuti.

Material examined: 17 ♂, 22 ♀. — Austria: 2 ♀, Gr. Glockner, Guttal, 2000 m, e.l. iv.1944, *Alnus viridis*, J. Klimesch (ZMA). — France: 1 ♂, 1 ♀, Pralognan (Savoie), 1450 m, e.l. 17—19.v.1980, *Alnus viridis*, E. J. van Nieukerken (ZMA). — Great Britain: 1 ♀ (lectotype, see above). — Italy: 1 ♀, Riva di Tures (Rain in Taufers), Knuttental, 1800 m, 14.vi.1976, G. Derra (coll. Derra). — Netherlands: 2 ♀, Lochem, Ampsenske Veld, e.l. 16—18.iv.1983, *Betula pubescens*, E. J. van Nieukerken; 1 ♀, Rockanje: Voornes Duin, e.l. 20—21.v.1980, *Betula pubescens*, E. J. van Nieukerken (ZMA). — Norway: 1 ♂, 1 ♀, Alta (Alten), 1.vii, Staudinger (MHUB); 4 ♂, 3 ♀, Grovudalen, 900 m, 62.27 N, 8.54 E, e.l. 5—22.v.1981, *Betula pubescens*, E. J. van Nieukerken; 1 ♂, 1 ♀, 2 km E. Oppdal, 650 m, e.l. 7—8.v.1981, *Betula pubescens*, E. J. van Nieukerken; 6 ♂, 6 ♀, 11 km W. Rennebu, 600

m, e.l. 30.iv—12.v.1981, *Betula pubescens*, E. J. van Nieukerken (ZMA). — Switzerland: 1 ♂, 1 ♀ (lecto- and paralectotype of *viridicola*), Simplon, 1970 m, mine 19.ix.1936, *Alnus virid.*, Weber (ETHZ); No locality data: 3 ♂, 2 ♀, bred in captivity (from Norwegian material), e.l. 8—21.v.1982, *Betula* (ZMA).

Mines. — On *Alnus viridis*. — Austria: Lavamund. — France: Pralognan. — Italy: Trento. — Switzerland: near Genève. On *Betula nana*. — Norway: Grøvdalen. On *Betula pendula*. — Germany, West: Oberstadtfeld. On *Betula pubescens*. — France: Pralognan. — Netherlands: Dalfsen; Griendtsveen; Den Ham; Lochem; Mariënberg; Oostvoorne; Ootmarsum; Rockanje; Vilsteren; Vorden. — Norway: Grøvdal; Grøvdalen; Hoem; Oppdal; Rennebu.

NAMES OF DOUBTFUL STATUS, PROBABLY  
BELONGING TO *ECTOEDEmia*

*Nepticula bistrimaculella* Heyden, 1861: 40.

According to Dr. H. Schröder (in litt.) there is no type-material of this species left in the Heyden collection in Frankfurt. From the description it seems to belong to the *subbimaculella* complex and to feed on *Betula*. Most likely this refers to an unusual case of xenophagy of either *heringi* or *subbimaculella*.

*Nepticula gilvella* Rössler, 1866: 395; 1881: 338.

No material of this species is present in the Rössler collection in Wiesbaden (Dr. M. Geisarthardt, in litt.) nor in Strasbourg (Dr. J. Matter, in litt.). The description is vague, so the identity of this species remains obscure. It could belong to one of the *Quercus* feeding *Ectoedemia* species.

CATALOGUE OF HOSTPLANTS OF WESTERN PALAEARCTIC *ECTOEDEmia*

(Occasional occurrence on unusual hostplants in brackets)

SALICACEAE

<i>Salix fragilis</i> L.	<i>E. intimella</i>
<i>Salix caprea</i> L.	<i>E. intimella</i>
<i>Salix cinerea</i> L.	<i>E. intimella</i>
<i>Salix pentandra</i> L.	<i>E. intimella</i> , ( <i>occultella</i> )
<i>Salix phylicifolia</i> L.	<i>E. intimella</i>
<i>Populus alba</i> L.	<i>E. klimeschi</i> , <i>turbidella</i>
<i>Populus canescens</i> (Aiton) Sm.	<i>E. turbidella</i>
<i>Populus tremula</i> L.	<i>E. argyropeza</i>
<i>Populus nigra</i> L.	<i>E. hannoverella</i> , ( <i>turbidella</i> ?)
<i>Populus</i> × <i>canadensis</i> Moench.	<i>E. hannoverella</i>

BETULACEAE (incl. Corylaceae)

<i>Betula pendula</i> Roth.	<i>E. occultella</i> , <i>minimella</i>
<i>Betula pubescens</i> Ehrh.	<i>E. occultella</i> , <i>minimella</i>
<i>Betula nana</i> L.	<i>E. occultella</i> , <i>minimella</i>
<i>Alnus viridis</i> (Chaix) DC. in Lam. & DC.	<i>E. minimella</i>
<i>Corylus avellana</i> L.	( <i>E. minimella</i> )
<i>Carpinus betulus</i> L.	<i>E. (Zimmermannia)</i> spec.

FAGACEAE

<i>Fagus sylvatica</i> L.	<i>E. liebwerdella</i>
<i>Castanea sativa</i> Miller	<i>E. (Zimmermannia)</i> spec., <i>E. albifasciella</i> , <i>heringi</i>
<i>Quercus coccifera</i> L.	<i>E. cf. algeriensis</i> , <i>haraldi</i> , <i>suberis</i> , <i>andalusiae</i> , cf. <i>caradjai</i>
<i>Quercus ilex</i> L. and <i>rotundifolia</i> Lam.	<i>E. (Zimmermannia)</i> spec., <i>E. algeriensis</i> , <i>ilicis</i> , <i>heringella</i> , <i>haraldi</i> , <i>suberis</i>
<i>Quercus suber</i> L.	<i>E. haraldi</i> , <i>ilicis</i> , <i>suberis</i>
<i>Quercus macrolepis</i> Kotschy	<i>E. aegilopidella</i>
<i>Quercus alnifolia</i> Poech	<i>E. heringella</i> , <i>alnifoliae</i>
<i>Quercus infectoria</i> Olivier	<i>E. cf. caradjai</i>
<i>Quercus cerris</i> L.	? <i>E. caradjai</i> , <i>gilvipennella</i> , <i>cerris</i> , ( <i>subbimaculella</i> ), <i>lichtensteini</i> , <i>phyllostomella</i>



<i>Quercus petraea</i> L. s.l.	<i>E. caradjai</i> , <i>quinguella</i> , <i>nigrosparsella</i> , <i>albifasciella</i> , <i>subbimaculella</i> , <i>heringi</i>
<i>Quercus robur</i> L.	<i>E. atrifrontella</i> , <i>longicaudella</i> , <i>quinguella</i> , <i>albifasciella</i> , ( <i>contorta</i> ), <i>subbimaculella</i> , <i>heringi</i>
<i>Quercus frainetto</i> Ten.	<i>E. caradjai</i> , <i>E. albifasciella</i> complex
<i>Quercus pyrenaica</i> Willd.	<i>E. subbimaculella</i>
<i>Quercus pubescens</i> Willd. s.l.	<i>E. atrifrontella</i> , <i>caradjai</i> , <i>nigrosparsella</i> , <i>pubescivora</i> , <i>contorta</i> , <i>subbimaculella</i> , <i>heringi</i> , (? <i>liechtensteini</i> )
<i>Quercus faginea</i> Lam.	? <i>E. atrifrontella</i> , <i>E. cf. suberis</i> , <i>heringi</i>
<i>Quercus ehrenbergi</i> Kotschy	<i>E. caradjai</i>

## ULMACEAE

<i>Ulmus</i> spp.	<i>E. amani</i> , <i>preisseckeri</i>
-------------------	---------------------------------------

## ROSACEAE

<i>Spiraea media</i> Franz Schmidt	<i>E. spiraeae</i>
<i>Filipendula vulgaris</i> Moench	<i>E. hexapetalae</i> , <i>angulifasciella</i>
<i>Agrimonia eupatoria</i> L.	<i>E. agrimoniae</i> , (? <i>rubivora</i> , ? <i>arcuatella</i> )
<i>Aremonia agrimonoides</i> (L.) DC.	<i>E. agrimoniae</i>
<i>Rubus chamaemorus</i> L.	<i>E. rubivora</i>
<i>Rubus arcticus</i> L.	<i>E. rubivora</i>
<i>Rubus saxatilis</i> L.	<i>E. rubivora</i>
<i>Rubus caesius</i> L.	<i>E. rubivora</i>
<i>Rubus fruticosus</i> L. aggr.	<i>E. rubivora</i> , <i>erythrogenella</i>
<i>Rubus ulmifolius</i> Schott	<i>E. erythrogenella</i>
<i>Rosa</i> spp.	<i>E. angulifasciella</i>
<i>Sanguisorba officinalis</i> L.	<i>E. angulifasciella</i>
<i>Sanguisorba minor</i> Scop.	<i>E. angulifasciella</i>
<i>Potentilla erecta</i> (L.) Räscher	<i>E. arcuatella</i>
<i>Potentilla sterilis</i> (L.) Garcke	<i>E. arcuatella</i>
<i>Fragaria vesca</i> L.	<i>E. arcuatella</i>
<i>Fragaria moschata</i> Duchesne	<i>E. arcuatella</i>
<i>Pyrus communis</i> L.	<i>E. atricollis</i>
<i>Malus sylvestris</i> Miller	<i>E. atricollis</i>
? <i>Sorbus</i> sp.	<i>E. atricollis</i>
<i>Mespilus germanica</i> L.	<i>E. atricollis</i>
<i>Crataegus laevigata</i> (Poir.) DC.	<i>E. atricollis</i>
<i>Crataegus monogyna</i> Jacq.	<i>E. atricollis</i>
<i>Prunus dulcis</i> (Miller)	<i>E. spinosella</i>
<i>Prunus tenella</i> Batsch	<i>E. mahalebella</i>
<i>Prunus cerasifera</i> Ehrh.	<i>E. spinosella</i> ?, ( <i>atricollis</i> )
<i>Prunus spinosa</i> L.	<i>E. spinosella</i>
<i>Prunus domestica</i> L.	<i>E. spinosella</i> , (? <i>mahalebella</i> , ? <i>atricollis</i> )
<i>Prunus fruticosa</i> Pallas	<i>E. mahalebella</i>
<i>Prunus coccomilia</i> Ten.	<i>E. mahalebella</i>
<i>Prunus avium</i> L.	<i>E. atricollis</i> , <i>mahalebella</i>
<i>Prunus cerasus</i>	<i>E. mahalebella</i>
<i>Prunus mahaleb</i>	<i>E. mahalebella</i> , ( <i>atricollis</i> )

## ANACARDIACEAE

<i>Pistacia terebinthus</i> L.	<i>E. terebinthivora</i>
--------------------------------	--------------------------

## STAPHYLEACEAE

<i>Staphylea pinnata</i> L.	<i>E. atricollis</i>
-----------------------------	----------------------

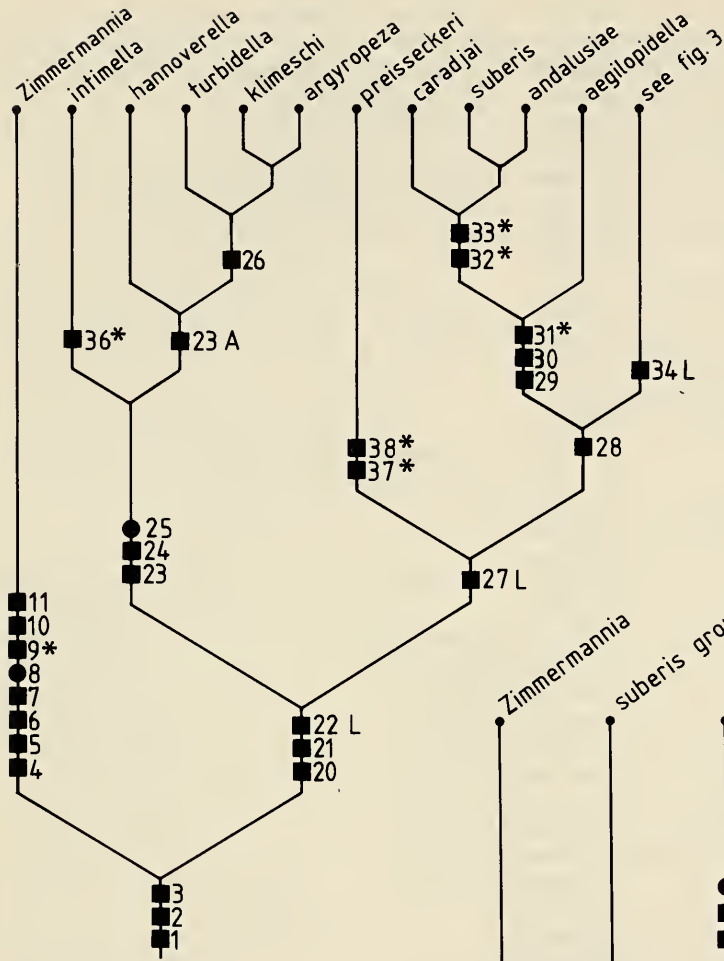

1

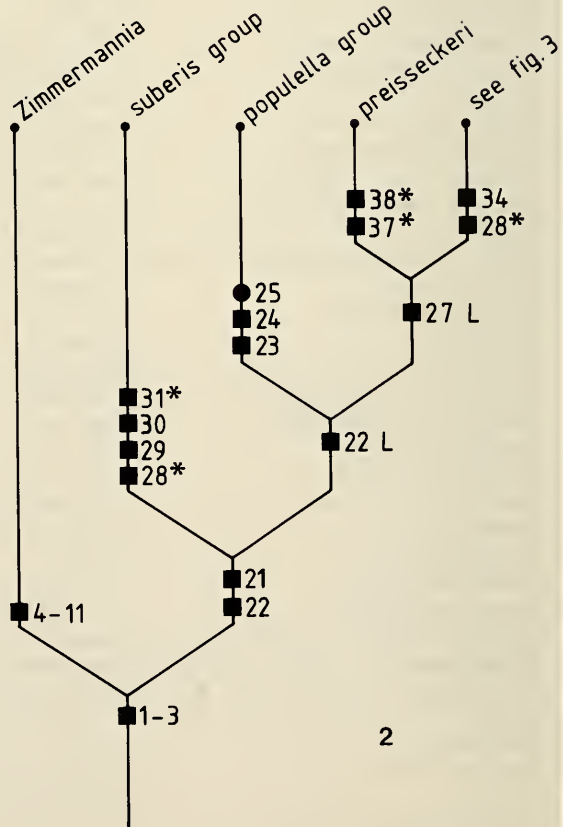

2

PHYLOGENY

I have attempted to reconstruct the phylogeny of *Ectoedemia*, using the cladistic approach as outlined by Hennig (1966) and refined amongst others by Wiley (1981).

Many difficulties arose with the assessment of the polarity of character states, especially within the subgenus *Ectoedemia*, since at first sight there seemed to be no correlation at all between the character distributions. This means that there is a considerable amount of either homoplasy, secondary reduction, reversal or cases of underlying synapomorphies (Saether, 1979), which require many ad hoc statements to explain apparently conflicting evidence. It must be stressed that many of such characters are relatively simple morphological structures, which therefore might have a simple genetic basis. If so, reversals and parallelisms could appear quite often in the course of evolution. Therefore it is not always feasible to use parsimony, where only the number of "ad hoc" statements counts,

not their quality. The most parsimonious cladogram should only be chosen after some qualification or weighing of the "ad hoc" statements. For instance reduction of a simple structure is a much more likely event than the parallel development of a complex structure.

Another weak point in the phylogeny presented and discussed below, is that several monophyletic groups are defined by one character only. Moreover these characters are frequently suspected to be homoplasies, but similarity both in morphology and biology often coincides with the groups defined in the cladogram, and although part of this similarity might be based on plesiomorphies, it is also very likely that apomorphies, which can at present not be defined easily, play an important role in this similarity. An extension of this analysis with Nearctic and eastern Palearctic species, and larvae could resolve some of the existing uncertainties.

The following analysis has been carried out by hand and as a consequence of the high pro-

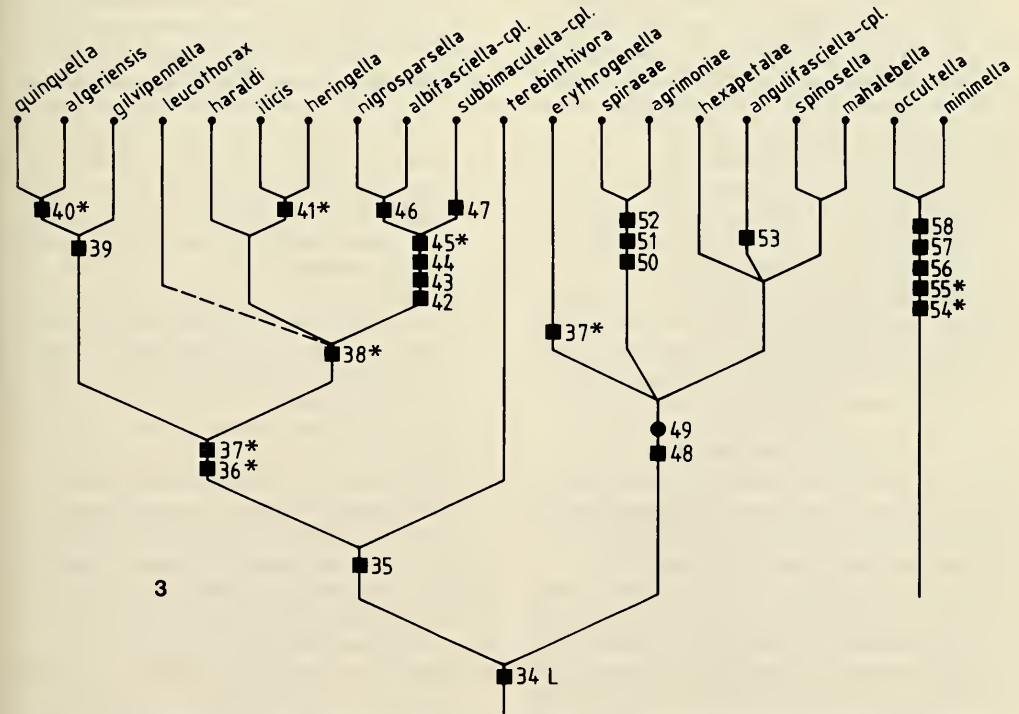

Figs. 1—3. Cladograms representing proposed phylogeny within *Ectoedemia*. Black squares denote apomorphies; black dots characters with uncertain status. Character numbers explained in text; in-group parallelisms marked with an asterisk, frequent secondary loss denoted by L.

Figs. 1 and 2 give two alternative phylogenies for the basic branching in the genus, fig. 3 details the right branch of figs. 1 and 2.



portion of conflicting evidence, can only be regarded as a very rough preliminary analysis, open to further tests. The supposed apomorphies found with the outgroup-rule are given for pairs and groups of species. Autapomorphies for single species are not given here. Cladograms representing the proposed phylogenies are presented in figs. 1—3.

#### - Sistergroup and monophyly of *Ectoedemia*

The sistergroup of *Ectoedemia* s.str. and *E. (Zimmermannia)* should be sought for amongst the taxa *Fomoria* Beirne, *Laqueus* Scoble or *Etainia* Beirne (van Nieukerken, in preparation). For neither of them convincing arguments have been found, so for the following outgroup comparisons all these taxa together have been taken into consideration. The following apomorphies support the monophyly of the two subgenera treated here and therefore corroborate the earlier suggestion of monophyly based on character 1 only (Scoble, 1983).

1. Loss of uncus. — The classical character (Beirne, 1945; Scoble, 1983). The uncus is also absent in Holarctic species of *Etainia*, but since it is present in some South African *Etainia* species, it has probably been lost independently. An uncus is present in almost all other Nepticulidae.
2. Sensillum vesiculocladum blisterlike, not branched (van Nieukerken & Dop, in preparation). — A more or less similar situation in some species of *Fomoria* is tentatively regarded as a parallelism.
3. Female with single sensillum vesiculocladum per flagellar segment (van Nieukerken & Dop, in preparation). — A unique character, checked for many species, representing all species groups.

#### Subgenus *Zimmermannia*

The Palaearctic and Nearctic species share a number of uniquely derived characters which demonstrate the monophyly of this subgenus, and therefore justify its re-establishment.

4. Larvae barkmining. — The basic feeding pattern in Nepticulidae larvae is leaf-mining. Although some other species make mines in bark of branches or shoots, only *Zimmermannia* larvae make mines in the bark of thick branches or trunks of trees, especially Fagaceae. This character led Hering (1940) to erect the genus *Zimmermannia*, but later authors doubted the validity of this character to define a taxon

(i.e. Wilkinson & Newton, 1981). In my opinion it is a sound autapomorphy for the subgenus.

5. Larval life lengthened, with 6—8 instars. — As a rule Nepticulidae larvae have four or five larval instars, with probably four as the most generalised condition (van Nieukerken & Jansen, in preparation). However, this apomorphy is subject to some reservation as it is only known with certainty for *atrifrontella*, *liebwerdella* and *longicaudella*.
6. Colour pattern of forewings largely lost, colour uniform or irrorate. — The presence of light dots or fasciae is assumed to be the generalised condition in Nepticulidae.
7. Male hindwing with pronounced costal emargination. — The costal emargination, unknown outside *Zimmermannia*, is associated with the relatively long hair-pencil. In some species with reduced or without hair-pencil, the emargination is absent. A hair-pencil is considered to belong to the ground-plan of *Ectoedemia* and is also present in several non-European species of *Etainia*, *Laqueus* and *Fomoria*. Therefore the reduction of the hair-pencil and hence of the emargination are thought to be secondary (character 18).
8. Large size of ventral carinae and corresponding dorsal fold of valva. — A peculiar feature, which is clearly seen in undivided genitalia.
9. Female with many long tactile setae on tergites 7 and 8. — This character needs investigation in Nearctic species. It is probably secondary reduced in *amani* and *liguricella* (character 19).
10. Bursa copulatrix extremely long and narrow.
11. Margin of signa wider than individual cells.

The available characters are insufficient to present a cladogram of the western Palaearctic species of *Zimmermannia*, however some supposed apomorphies for groups of species are given below and listed in table 1.

12. Aedeagus constricted.
13. Dorsal and dorsolateral carinae connected by rim.

Characters 12 and 13 show the sister-relationship between *atrifrontella* and *liebwerdella*.

14. Vesica with folded sclerotised plate. — This character is shared by the first three

Table 1. Data-matrix of some important characters in *Ectoedemia* (*Zimmermannia*) species. Species given with their number and first three letters of epitheton, characters and numbers refer to text. — 1 = character present (supposed apomorphy), 0 = character absent (either by plesiomorphy or secondary reduction), ? = status unknown.

Spec.	atr	lie	lon	his	mon	ama	nur	lig
Char.	1	2	3	4	5	6	7	8
12	1	1	0	0	0	0	0	0
13	1	1	0	0	0	0	0	0
14	1	1	1	?	0	0	0	0
15	0	0	1	1	1	1	1	1
16	0	0	1	?	1	1	1	1
17	0	0	0	0	1	1	0	0
18	0	0	0	0	0	0	1	1
19	0	0	0	0	0	1	0	1

species and therefore in conflict with the following characters.

15. Valva with inner (mesal) lobe. — This lobe is only slightly developed in *longicaudella* and *nuristanica*.
  16. Ductus spermathecae with more than 3½ convolutions. — The basic number is 2 to 3 convolutions, increase of this number occurred independently in various other groups.
- Characters 15 and 16 indicate a monophyly of the species 3 to 8, but they are both only slightly developed in *longicaudella*, which together with character 14 make its position uncertain. The valval lobe is also only slightly developed in *nuristanica*, but it is present in many Nearctic species, and it is therefore not at all unlikely that the lobe belongs to the ground-plan of *Zimmermannia* and has been lost in a few species.
17. Vesica with stout sclerotised cornutus. — Present in *amani*, *monemvasiae* and also in several Nearctic species, in which the cornutus bears also many secondary spines. It is not clear if this character is a homologue of the sclerotised plate (character 14) and hence part of the same transformation series. In that case either 14 or 17 is invalid as autapomorphy.
  18. Loss of hair-pencil (and costal emargination) in ♂. — See character 7.
  19. Loss of long setae on abdominal tip in ♀. — See character 9.

#### Subgenus *Ectoedemia* s.str.

The following characters of the female genitalia are assumed to be apomorphic for the subgenus:

20. Vestibulum with circular vaginal sclerite. — Vaginal sclerites are present in several other nepticulids and according to Scoble (1983) belong to the ground plan of *Trifurculini*, but they usually have a different shape from the type here, which is unique for *Ectoedemia* s.str. It is only absent in *spiraeae* and *agrioninae*.
21. Vestibulum with spiculate pouch. — Probably correlated with 20, this is another unique character for the subgenus, which is absent in the same two species and *hexapetalae*, and less distinct or without spicules in some other species.
22. Vestibulum with patch of densely packed pectinations. — Shared by all species of the *populella* group, *subbimaculella* group, *preisseckeri*, *terebinthivora* and *erythrognella*. It is either another synapomorphy for the subgenus (fig. 1) or of a large part (fig. 2), but in both cases secondarily lost in many species.

The subgenus also exhibits high uniformity in several other characters. For instance in the shape of the valva, the aedeagus and genital capsule; the general shape of the female genitalia and several biological characters. Yet it appears to be impossible to ascribe any of these similarities to straightforward apomorphies, indeed some of them are rather plesiomorphic. Some other features, which easily identify a species as belonging to *Ectoedemia* s.str. cannot be regarded as belonging to the groundplan because they are absent in too many species, to explain them all as secondary losses. However, present evidence justifies the acceptance of *Ectoedemia* s.str. as a monophyletic entity.

Subdivision of the subgenus into species groups is desirable, for coping with the large number of species. The aim has been to make monophyletic groups, but on the basis of the species treated here, it is difficult, and the subdivision only tentative. The groups used here are recognised by a combination of similarities in both morphological and biological characters. For some species which were hard to place, the biology provided the decisive factors, so that all groups recognised here feed on one hostplant family. Most of these groups are likely to be monophyletic, but at least one is suspected to be paraphyletic. With the characters given, I have presented two alternative phylogenies in figs. 1—3, but both still require many ad hoc



statements. The characters used are discussed below and partly presented in the data-matrix in table 2. Characters are treated in the order in which they appear in the cladograms figs. 1 and 3, which I regard at present as the best alternatives. The sequence of species in the main body of the text also follows these cladograms.

The *populella* group forms one of the best defined groups in *Ectoedemia*, with a high overall similarity and the following supposed apomorphies:

23. Petiole or midrib miners. — Just as in the case of *Zimmermannia*, this feeding pattern is so unique and different from leaf-mining, that it can be safely regarded as an apomorphy for the *populella* group. Within this group the petiole-mining is probably more derived than the midrib mine of *intimella* in *Salix*, which could be the first step in the evolution from a "normal" leaf-mine into a petiole mine. Hence, the petiole-mine in *Populus* is regarded here as a further step in the transformation series and as such used with number 23A in fig. 1. A mine on *Ostrya*, strikingly similar to that of *intimella*, has been figured by Clemens (1872: figure on p. 27), but remains undescribed.
24. Hostplant: Salicaceae. — The character "hostplant" is difficult to interpret, but certainly useful in some cases. It is possible that oak (*Quercus*) is the ancestral hostplant for *Ectoedemia* s.str. because it is also the main hostplant for the sister-group, *Zimmermannia*. This explains the fact why two rather different groups mine in *Quercus*; they have retained their plesiomorphic hostplant. Salicaceae certainly seems to be a good apomorphy. In other leaf mining taxa, species feeding on Salicaceae are closely related (*Stigmella*, *Phyllocnistis*).
25. Denticles on spiculate pouch single, equally spaced. — This character is diagnostic for the *populella* group, but it is impossible to decide if it is derived or ancestral.

On grounds discussed above *intimella* is regarded as the sister-species of the remaining *Populus* feeding species. The following character seems to be an apomorphy for *turbidella* and *klimeschi*.

26. Aedeagal carinae very well developed and large. — The total configuration of aedeagus, and in fact the male genitalia as a whole is very similar in these two species. This character is of course inappropriate

for the parthenogenetic *argyropeza*. On the basis of high similarity this species can be regarded as closely related to *klimeschi*, which might be the sexually reproducing ancestor of *argyropeza*.

For the remaining species groups the following character is tentatively regarded as the only apomorphy:

27. Second and third larval instar with 12 ventral plates. — A unique character present in many species of *Ectoedemia* s.str., but again often absent from closely related species. It does not occur in the *populella* group and *suberis* group. It is supposed to be an apomorphy for the subgenus without the *populella* group in fig. 1 or for the subgenus without the *suberis* group in fig. 2. It is either lost in the species in which it is absent, or it is an underlying apomorphy.

*E. preisseckeri* has some affinities with the *albifasciella* complex but since it lacks apomorphies 28, 35 and 36 is placed here in a group of its own, as a sister-group of the remaining species. It is probably closely related to the Nearctic *E. ulmella* (Braun).

All other species belong to one monophyletic entity on the basis of the following apomorphy:

28. Aedeagus with only one pair of carinae. — Within *Ectoedemia* s.l. the presence of several (2—4) pairs of carinae is widespread in the other subgenera, and therefore the plesiomorphic condition on grounds of out-group argument. In cladogram fig. 1 the reduction to one pair is regarded as an apomorphy for the remaining groups. The very similar configuration of the carinae in all species favours this solution, but a reduction on several occasions cannot be excluded and leads for instance to the cladogram in fig. 2. In *spiraeae* the dorsal carinae are also lost.

The species of the *suberis* group share the following apomorphies:

29. Aedeagus very long in relation to capsule.
30. Signa oval. — The plesiomorphic condition of the signa seems to be narrow elongate.
31. Larva green. — Most nepticulid larvae are yellow or more transparent white. Bright green larvae occur scattered throughout the family, especially in *Stigmella*, but in *Ectoedemia*, apart from all species in the *suberis* group only *algeriensis* and *gilvipennella* have green larvae.

Within the *suberis* group, *aegilopidella* takes an isolated position, but the remaining species





form a tight group with the following apomorphies:

32. T7 and 8 with many long tactile setae. — This apomorphy occurs in various distantly related species, feeding on evergreen *Quercus*. It could be an apomorphy for this part of the *suberis* group, and secondarily lost in *andalusiae*.
33. Ductus spermathecae with more than 3½ convolutions. — Although the increase of the number of convolutions occurred several times in Nepticulidae, it is supposed that it is an apomorphy for this part of the *suberis* group.

The remaining species of *Ectoedemia* s.str. most likely form a monophyletic unit, at least based on character 34. In fig. 2 character 28 is also an apomorphy but as a parallelism with the *suberis* group. The phylogeny within this part of the genus is still far from resolved, the characters showing a very complicated pattern, but a tentative phylogeny is given in fig. 3.

34. Gnathos with central element divided into distal spatulate and basal serrate part. — The single, smooth central element is the generalised condition in Nepticulidae (Scoble, 1983). The "divided" gnathos only occurs in the *subbimaculella* group, excluding the two species complexes and *nigroparsella*, and in the *angulifasciella* group, excluding the first three species. Since the structure is so uniform, it is most unlikely that it originated twice independently, therefore its absence in part of these groups must be explained by reversal or its presence by underlying synapomorphy. Alternatively this character is only an apomorphy for species 20—26 and 42—48 together, in which case the hypotheses of monophyly of the *subbimaculella* group and *angulifasciella* group both must be refuted, but on parsimonious grounds I prefer the present solution.

*E. terebinthivora* and the *subbimaculella* group are here regarded as sister-groups on the basis of the following:

35. Signa distinctly dissimilar in shape. — Here the dorsal signum is much longer than the ventral, it reaches almost into the vestibulum, and the shape of the posterior part is different from the other signum. A slightly similar situation occurs in *spiraeae*.

The *subbimaculella* group is considered a monophyletic entity on the basis of the next two characters:

36. Corpus bursae without pectinations. — Pectinations on the bursa belong to the ground-plan of Nepticulidae, their loss is therefore an apomorphy. The only other *Ectoedemia* species with this character, probably as a parallelism, is *intimella*.
37. T7 with a distinct row of setae along anterior margin of T8. — This row occurs in most species of the *subbimaculella* group but also in *preisseckeri* and *erythrogenella*. Probably it has secondarily evolved into a group of long setae similar to character 32 in the species *algeriensis* and *leucothorax*.

A large part of this group shares the following character:

38. Costal bristles present in male. — The interpretation of this character is open to doubt. In itself the presence of costal bristles belongs to the groundplan of Nepticulidae. Costal bristles and the male hair-pencil are homologous structures; they always occur more or less in the same position, and hair-pencil and costal bristles are mutually exclusive. The presence of a hair-pencil is regarded as part of the groundplan of *Ectoedemia* s.str., and in this case the presence of costal bristles can best be explained as a reversal and therefore an apomorphy within the subgenus. The alternative explanation that these species retained the plesiomorphic condition implies the parallel development of a hair-pencil in many cases, in which case it could be based on an underlying apomorphy. The evidence here is not sufficient to eliminate this explanation entirely, but the presence of this character in a group of species, which also shares other attributes favours the reversal interpretation at present.

The remaining three species, *quinquella*, *algeriensis* and *gilvipennella*, possess a hair-pencil, in this interpretation the plesiomorphic condition of 38. They are tentatively placed as the sister-group of the other species of the *subbimaculella* group with the following possible apomorphy:

39. Forewing with a pale discal spot in second half. — A distinct feature of *quinquella* and *algeriensis*. *E. gilvipennella* has a completely pale forewing with some scattered dark scales, which can be explained as an enlargement of the white spots and hence as a further step in the transformation series 39, but this remains a weak character which needs corroboration.

*E. quinquella* and *algeriensis* clearly form a pair of sister species, based on the following apomorphy and corroborated by their high similarity:

40. Male hindwing with patch of special scales near hair-pencil.

*E. leucothorax* cannot be placed with certainty in the cladogram. The next three species, *baraldi*, *ilicis* and *heringella* are considered to form a monophyletic group, merely based on similarities. Especially mine form and life history are very similar. *E. ilicis* and *E. heringella* are most likely sister-species with the following apomorphy:

41. Loss of costal spot in forewing.

*E. nigrosarsella*, the *albifasciella* complex and the *subbimaculella* complex form a well defined monophyletic entity based on the following characters:

42. Valva with many setae on inner (mesal) surface.

43. Gnathos smooth and undivided. — A reversal of character 34.

44. Mine type. — The *albifasciella* and *subbimaculella* complexes have a unique mine type: a narrow gallery, usually following a vein, abruptly enlarging into a square or triangular blotch, often in vein axil. Only *nigrosarsella* has a different type but is on other grounds regarded as a relative of the *albifasciella* complex.

45. Hostplant deciduous *Quercus*. — This might be correlated with character 44. Evergreen species form the majority of the Fagaceae and deciduous forms occur exclusively in temperate regions. From this fact it seems likely that ancestral oak-mining Nepticulidae lived on evergreen oaks. However, this point needs further research, especially in the extensive evergreen cupuliferous forests in east and southeast Asia.

The *albifasciella* complex and *nigrosarsella* are characterised by:

46. Convolutions of ductus spermathecae widened. — Except in *albifasciella* the number of convolutions is also increased. On the grounds of the number of convolutions *nigrosarsella* seems close to *contorta*, but otherwise it is quite different from the complex.

The *subbimaculella* complex can be characterised by:

47. Forewing with basal spot.

The *angulifasciella* group is a rather loose ag-

gregate of species sharing the hostplant (*Rosa*-ceae, character 48), which can hardly be regarded as a sound synapomorphy, considering the wide variety of unrelated Nepticulidae and many other Microlepidoptera feeding on this plant family. The following morphological character might be the only true synapomorphy for this group:

49. Forewing with metallic coloured fascia. — This is not or hardly developed in *spiraetae* and *hexapetalae*, and remains a weak character. It is not unlikely that this group is in fact paraphyletic in terms of either the *subbimaculella* or *occultella* group or both. Especially *E. erythrogonella* is different from other species in the group, and shares character 37 with the *subbimaculella* group, and moreover resembles *albifasciella* externally.

*E. spiraetae* and *agrimoniae* form a pair on the following grounds:

50. Vaginal sclerite lost.

51. Spiculate pouch lost.

52. T8 in female divided.

The remaining species of this group possibly form a monophyletic entity based on their similarity, but I failed to find a distinct apomorphy. The branching within this group is presented as an unresolved trichotomy between *hexapetalae*, the *angulifasciella* complex and the pair *spinose* and *mahalebella*. For the *angulifasciella* complex the following character is an apomorphy:

53. Carinae with many basal spines.

The *occultella* group is a sound monophyletic entity on the following apomorphies:

54. Cilia-line lost.

55. Tegumen cuspidate.

56. Carinae divided into blunt ending processes.

57. Pectinations on bursa arranged in bands.

58. Hostplant Betulaceae.

However, the affinities of this group are not clear. It must be placed somewhere between the *suberis* and *angulifasciella* groups since it shares characters 27 and 28 with those groups, but any indication about its sister-group relationship is lacking, hence its tentative placement at the end.

#### BIOGEOGRAPHY

Discussion of the biogeography is limited to a few remarks owing to the scanty knowledge of the distribution. The subgenera discussed here are both widely distributed in the Holarctic region, probably with the highest number of



(mostly unknown) species in the Eastern Palearctic, as indicated by some preliminary work on that fauna. In the Southern Hemisphere only *Ectoedemia* s. str. is known with three species from South Africa (Scoble, 1978, 1979), a very low number in relation to the total number of species (Scoble, 1983). In a large collection of Australian Nepticulidae the genus was not present (Scoble, 1983), neither was it in New Zealand (Donner and Wilkinson, pers. comm.). Unfortunately little is known from the Oriental and Neotropical regions, so that the conclusion that the group is predominantly Holarctic is not yet justified. In fact, the high number of Fagaceae feeding species might lead to the assumption that these subgenera are well represented in the Fagaceous forests of the Oriental region.

Many of the widespread European species probably have a distribution which goes much further east, but hardly any data are available from the Soviet Union. Many species are restricted to the mediterranean region and some of these (*quinquella*, *erythrogenella*) have an atlantic-mediterranean distribution type.

The species pairs *heringella-ilicis* and *contorta-pubesivora* are examples of vicariant species pairs with an eastern and western mediterranean element. These species are closely related and feed on the same hostplant, so that they most likely originated from populations isolated during the glaciation in west or east mediterranean refugia.

#### ACKNOWLEDGEMENTS

I would like to thank the following people for the loan of material and for information: Mrs. P. Arduino (Roma), Prof. Dr. R. Buvat (Marseille), Dr. A. Casale (Torino), Dr. D. R. Davis (Washington, D.C.), Mr. G. Derra (Bamberg), Dr. W. Dierl (München), Dr. J. P. Duffels (Amsterdam), Dr. W. Foster (Cambridge), Mr. A. van Frankenhuyzen (Wageningen), Dr. M. Geisthardt (Wiesbaden), Dr. Ph. Georges (Brussel), Mr. C. Gielis (Lexmond), Dr. L. Gozmány (Budapest), Dr. F. Gregor (Brno), Mr. B. Gustafsson (Stockholm), Dr. H. Hanigk (Lobbach), Prof. Dr. H. J. Hannemann (Berlin), Mr. W. Hogenes (Amsterdam), Mr. K. J. Huisman (Melissant), Mr. R. Johansson (Växjö), Dr. R. de Jong (Leiden), Mr. O. Karsholt (København), Dr. F. Kasy (Wien), Dr. J. Klimesch (Linz), Mr. J. Koster (Callantsoog), Dr. N. P. Kristensen (København), Mr. J. Kuchlein (Wageningen), Mr. J. Kyrki (Oulu), Mr. P. Leraut (Paris), Dr. G. Luquet (Paris), Dr. J. Matter

(Strasbourg), Dr. E. S. Nielsen (Canberra), Prof. Dr. D. Povolný (Brno), Dr. R. Puplesis (Leningrad), Prof. Dr. J. Razowski (Krakow), Dr. U. Roesler (Karlsruhe), Dr. K. Sattler (London), Prof. Dr. W. Sauter (Zürich), Dr. H. Schröder (Frankfurt), Mr. W. Speidel (Karlsruhe), Dr. P. D. Syme (Salt Ste. Marie), Dr. E. Traugott-Olsen (Marbella), Mr. K. Tuck (London), Dr. P. Viette (Paris), Dr. S. E. Whitebread (Magden) and Mr. J. Wolschrijn (Apeldoorn). Of these I would especially acknowledge the help of R. Johansson, for the wealth of unpublished data he allowed me to use in this work. For their hospitality and help during collecting trips I am indebted to Col. and Mrs. A. M. Emmet (Saffron-Walden), Mrs. A. Hallin and Mr. E. Traugott-Olsen (Marbella) and Dr. F. Kasy (Wien). I would like to thank my colleagues of the Vrije Universiteit — Dr. Koos Boomsma, Dr. Georgina Bryan and Dr. Steph Menken — for their advice and cooperation during the course of my studies and in joint collecting-trips, and Steph Menken also for all his data on allozyme studies of *Ectoedemia*. I am indebted for advice and critical remarks to Prof. Dr. C. Wilkinson, who also initiated this study. Similarly Dr. R. de Jong is acknowledged. Technical assistance by Mr. Kees Alders, Mr. Bart Jan van Cronenburg, Mrs. Daisy Kloos and Mr. Adri Rol, especially in preparation of genitalia and rearing work is much appreciated. I wish to acknowledge Messrs T. Feijen, P. W. A. van Huijstee and B. H. van Nifterik for assisting with photographic work, Mrs. Silvia Richter and Désirée Hoonhout for typing the manuscript, and Mr. L. Sanna for preparing figs. 1—3. For collecting trips to Greece and Central Europe grants were received from the Netherlands Organisation for the Advancement of Pure Research (ZWO) and the Uyttenboogaart-Eliassen foundation.

#### REFERENCES

- Ballet Fletcher, W. H., 1882. *Nepticula agrimoniae* Heyden, a species new to Britain. — Entomologist's mon. Mag. 18: 211.
- Bedell, G., 1848. Description of *Microsetia quinquella*, a new species of moth of the family Tineidae. — Zoologist 6: 1986.
- Beirne, B. P., 1945. The male genitalia of the British Stigmellidae (Nepticulidae) (Lep.). — Proc. R. Ir. Acad. (B) 50: 191—218.
- Borkowski, A., 1969. Studien an Stigmelliden (Lepidoptera). Teil I. Zur Verbreitung, Biologie und Ökologie der Stigmelliden in den polnischen Sudeten. — Polskie Pismo ent. 34: 95—122.

- Borkowski, A., 1970. Studien an Stigmelliden (Lepidoptera). Teil III. Beitrag zur Kenntnis der Stigmellidenfauna Polens. — *Polskie Pismo ent.* 40: 541—555.
- Borkowski, A., 1972. Studien an Nepticuliden (Lepidoptera). Teil IV. Bemerkungen zur Nomenklatur und Systematik der Familie Nepticulidae. — *Polskie Pismo ent.* 42: 689—709.
- Borkowski, A., 1975. Studien an Nepticuliden (Lepidoptera) Teil VI. Die Verbreitung der Nepticuliden in Polen. — *Polskie Pismo ent.* 45: 487—535.
- Bradley, J. D., D. S. Fletcher & P. E. S. Whalley, 1972. Kloet and Hincks. A checklist of British Insects. Second Edition (Revised) part 2: Lepidoptera. — *Handbooks Ident. Br. Ins.* 11(2): i—viii, 1—153.
- Buhr, H., 1935. Mecklenburgische Minen. III. Lepidopteren-Minen. — *Stett. ent. Ztg.* 96: 131—159.
- Busck, A., 1907. New american Tineina. — *Proc. ent. Soc. Wash.* 8: 86—99.
- Busck, A., 1913. Two microlepidoptera injurious to Chestnut. — *Proc. ent. Soc. Wash.* 15: 102—104.
- Busck, A., 1914a. The chestnut bastminer. — *Insector Inscit. menstr.* 2: 3, 4.
- Busck, A., 1914b. Descriptions of new Microlepidoptera of forest trees. — *Proc. ent. Soc. Wash.* 16: 143—150, pls. 7, 8.
- Clemens, B., 1872. In: Stainton, H. T. (ed.). *The Tineina of North America.* — John van Voorst, London.
- Davis, D. R., 1978. A revision of the North American moths of the superfamily Eriocranioidea with the proposal of a new family, Acanthopteroctetidae (Lepidoptera). — *Smithson. Contr. Zool.* 251: 1—131.
- Doets, C., 1947. *Zimmermannia heringiella* nov. spec. Nepticulidae (Lepidoptera). — *Tijdschr. Ent.* 88: 504—506.
- Dorfmann, H., 1960. Über das Vorkommen von Rindenminen in Berlin (Lepid.). — *Mitt. Dt. ent. Ges., E. V.*, 19: 17—19.
- Doubleday, H., 1859. *The zoologist synonymic list of British butterflies and moths*, 2nd ed. — Edward Newman, London.
- Draghgia, I., 1967. Insectes mineurs. — *Trav. Mus. Hist. nat. "Grigore Antipa"*, 7: 241—254.
- Dufrane, A., 1942. Microlépidoptères de la faune Belge (Ire note). — *Bull. Mus. r. Hist. nat. Belg.* 18(5): 10—12.
- Dufrane, A., 1949. Microlépidoptères de la faune Belge, (6e note). — *Bull. Inst. r. Sci. nat. Belg.* 25(13): 1—11.
- Dugdale, J. S., 1974. Female genital configuration in the classification of Lepidoptera. — *New Zealand J. Zool.* 1: 127—146.
- Emmet, A. M., 1970a. *Dechthiria turbidella* at Wicken Fen (Lep., Nepticulidae). — *Entomologist's Rec. J. Var.* 82: 37—41.
- Emmet, A. M., 1970b. *Stigmella spinosella* Joannis (Lep. Nepticulidae); a species new to Britain. — *Entomologist's Rec. J. Var.* 82: 121—123.
- Emmet, A. M., 1971. Notes on some of the British Nepticulidae. — *Entomologist's Rec. J. Var.* 83: 75—83, 136—142, 163—171, 240—248, 278—282, 300—304.
- Emmet, A. M., 1973. Notes on some of the British Nepticulidae. II. — *Entomologist's Rec. J. Var.* 85: 77—80, 176—180, 278—283.
- Emmet, A. M., 1974a. Notes on some of the British Nepticulidae. II. — *Entomologist's Rec. J. Var.* 86: 75—80, 103—108, 147—153.
- Emmet, A. M., 1974b. *Ectoedemia subapicella* (Stainton, 1886) (Lep., Nepticulidae) a synonym of *Ectoedemia albifasciella* (Heinemann, 1871). — *Entomologist's Gaz.* 25: 274—276.
- Emmet, A. M., 1947c. *Ectoedemia (Dechthiria) erythrognella* (de Joannis, 1907) (Lep.: Nepticulidae). A species new to Britain. — *Entomologist's Rec. J. Var.* 86: 129—130, pl. 9.
- Emmet, A. M., 1976. Nepticulidae. — In: J. Heath (ed.). *The moths and butterflies of Great Britain and Ireland* 1: 171—267, pls. 1—7, 11, 12.
- Emmet, A. M., 1979. Nepticulidae. — In: A. M. Emmet (ed.), *A field guide to the smaller British Lepidoptera*: 14—112. The British Entomological and Natural History Society, London.
- Ford, L. T., 1950. A new Stigmellid. — *Entomologist's Gaz.* 1: 39, 40.
- Frankenhuyzen, A. van & D. de Vries, 1979. Waarnezingen aan *Ectoedemia argentipedella* (Zeller), een mineermot op berk (Lep., Nepticulidae). — *Ent. Ber., Amst.* 39: 129—135.
- Freeman, T. N., 1962. A new species of *Nepticula* v. Heyd. on Birch (Lepidoptera: Nepticulidae). — *Can. Ent.* 94: 522, 523.
- Frey, H., 1856. Die Tineen und Pterophoren der Schweiz: i—xii, 1—430. — Meyer & Zeller, Zürich.
- Frey, H., 1857. Revision der Nepticuliden. — *Linn. ent.* 11: 351—446.
- Frey, H., 1858. *Nepticula agrimoniae*. — *Ent. Wkly Intell.* 4: 43, 44.
- Frey, H., 1870. Ein Beitrag zur Kenntniss der Microlepidopteren. — *Mitt. Schweiz. ent. Ges.* 3: 244—296.
- Gerasimov, A. M., 1952. Nasekomye česuekrylye 1, 2. Gusenicy. — *Fauna SSSR, N.S.* 56: 1—338.
- Glitz, C. T., 1872. Neue Microlepidopteren. — *Stett. ent. Ztg.* 33: 23—26.
- Gregor, F. & D. Povolný, 1955. Nové a významné nálezy lepidopter z Československa. (Neue und interessante Lepidopteren aus der Csr). — *Čas. morav. Mus. Brně* 40: 114—129.
- Gregor, F. & D. Povolný, 1983. Description of *Ectoedemia spiraeae* (Gregor & Povolný, 1955) and designation of type specimens of *Lithocolletis desertella* Gregor & Povolný, 1949. — *Čas. morav. Mus. Brně*, 68: 173—180.
- Grönlien, N., 1937. Tillegg til Norges Lepidopterfauna. — *Norsk ent. Tidsskr.* 5: 29—31.



- Groschke, F., 1944. Neues über Minierer aus dem Mittelmeergebiet. — Mitt. Münchn. ent. Ges. 34: 115—124.
- Gustafsson, B., 1981a. Characters of systematic importance in european Nepticulidae larvae (Lepidoptera). — Ent. scand. 12: 109—116.
- Gustafsson, B., 1981b. New leaf-mining moths of the family Nepticulidae from Cyprus, Greece (Lepidoptera). — Ent. scand. 12: 453—496.
- Haase, J., 1968. Zum Vorkommen von Rindenminen an Holzpflanzen in der DDR. — Ent. Ber., Berlin 1968: 61—68.
- Haworth, A. H., 1828. Lepidoptera Britannica. 4: 513—609. — J. Murray, London.
- Heinemann, H. von, 1862. Einige Bemerkungen über die Arten der Gattung *Nepticula*. — Wien. ent. Monatschr. 6: 237—268, 301—320.
- Heinemann, H. von, 1871. Nachtrag zu den Bemerkungen über die Arten der Gattung *Nepticula*. — Berl. ent. Z. 15: 209—223.
- Heinemann, H. von & M. F. Wocke, 1877. Die Schmetterlinge Deutschlands und der Schweiz. Zweite Abtheilung. Kleinschmetterlinge. Band 2. Die Motten und Federmotten. Heft 2: 389—825, 1—102, V—VI. — C. A. Schwetke und Sohn, Braunschweig.
- Hennig, W., 1966. Phylogenetic systematics. — University of Illinois Press, Urbana.
- Hering, M., 1932. Die Minenfauna von Tighina (Bender) in Bessarabien. (2. Beitrag zur Kenntnis der Minenfauna von Gross-Rumänien). — Bull. Sci. Acad. Roum. 15: 1—22.
- Hering, M., 1935. Minenstudien 15. — Z. PflKrankh. PflPath. PflSchutz 45: 1—15.
- Hering, M., 1940. *Zimmermannia liebwerdella* (Zimmermann). Ein Nachwort. — Mitt. zool. Mus. Berlin 24: 266.
- Hering, M., 1942. Eine neue *Nepticula* der *subbimaculella*-Gruppe, *Nepticula zimmermanni* spec. nov. von *Quercus pubescens* Willd. — Mitt. Dt. ent. Ges. 11: 26—29.
- Hering, M., 1943. Untersuchungen über die Weiden-Nepticuliden I. — Z. wien. ent. Ges. 28: 273—278.
- Hering, M., 1957. Bestimmungstabellen der Blattminen von Europa, 3 vols, 1185 pp., 725 figs. — Junk, 's-Gravenhage.
- Herrich-Schäffer, G. A. W., 1853—1855. Systematische Bearbeitung der Schmetterlinge von Europa, zugleich als Text, Revision und Supplement zu Jakob Hübner's Sammlung europäischer Schmetterlinge, 5, Die Schaben und Federmotten: 1—394, 124 + 7 + 1 pls. — G. J. Manz, Regensburg.
- Herrich-Schäffer, G. A. W., 1860. Revision der Europäischen Schmetterlingfauna. — KorrespBl. Sammler Ins. 1: 59—61.
- Herrich-Schäffer, G. A. W., [1861]. Neue Schmetterlinge aus Europa und den angrenzenden Ländern: 25—32, pls. 19—26.
- Heyden, C. von, 1843. (no titel). — Amtlicher Bericht der Versammlung der Naturforscher zu Mainz: 208.
- Heyden, C. von, 1861. Fragmente aus meinen entomologischen Tagebüchern. — Stett. ent. Ztg 22: 31—42.
- Hübner, J., [1814—1817]. Sammlung europäischer Schmetterlinge, 8. Tineae: pl. 65.
- Janmouille, E., 1947. Espèces nouvelles pour la Faune belge (suite). — Lambillionea 47: 2.
- Joannis, J. de, 1908a. Deux espèces nouvelles de *Nepticula* (Lep.). — Bull. Soc. ent. Fr. 1907: 326—329.
- Joannis, J. de, 1908b. Contribution à l'étude des Lépidoptères du Morbihan. — Annl. Soc. ent. Fr. 77: 688—838.
- Johansson, R., 1971. Notes on the Nepticulidae (Lepidoptera) I. A revision of the *Nepticula ruficapitella* group. — Ent. scand. 2: 241—262.
- Karsholt, O. & E. S. Nielsen, 1976. Systematisk fortegnelse over Danmarks sommerfugle. — Scandinavian Science Press Ltd., Klampenborg.
- Karsholt, O. & E. S. Nielsen, 1978. Nogle for den danske fauna nye småsommerfugle, med en oversigt over *Coleophora milvipennis*-grupper (Lepidoptera). — Ent. Meddr 46: 1—16.
- Kasy, F., 1965. Österreichische entomologische Expeditionen nach Persien und Afghanistan. — Ann. naturhist. Mus. Wien. 68: 653—666.
- Kasy, F., 1978. Die Schmetterlingsfauna des Naturschutzgebiete Hackelsberg, Nordburgenland. — Z. ArbGem. öst. ent. 30: 1—44.
- Kasy, F., 1980. Lepidopterologisch-faunistisch bemerkenswerte Neufunde aus Niederösterreich, IX. (7 für Österreich neue Kleinschmetterlingsarten). — Z. ArbGem. öst. Ent. 32: 47—48.
- Kasy, F., 1983. Die Schmetterlinge des WWF-Naturreservates "Hundsheimer Berge" in Niederösterreich. — Z. ArbGem. öst. Ent., 34, Suppl.: 1—48.
- Klimesch, J., 1936. Ein kleines Beitrag zur Kenntnis der Nepticulidenfauna (Lep.) des Vintschgaues (Prov. Bozen). — Stett. ent. Ztg 97: 194—211.
- Klimesch, J., 1940a. Beschreibung einiger neuer *Nepticula*-Arten (Lep., Nepticulidae). — Z. wien EntVer. 25: 79—81, 89—94, pls. 14, 15.
- Klimesch, J., 1940b. Über eine Nepticuliden-Ausbeute von Triest sowie Beschreibung der mine von *Leucospilapteryx cupediella* H.S. (Lep. Nepticulidae et Gracilariidae). — Z. wien. EntVer. 25: 176—179, 188—193, pl. 21.
- Klimesch, J., 1941. *Nepticula Preisseckeri* spec. nov. (Lep., Nepticulidae). — Z. wien. EntVer. 26: 162—168.
- Klimesch, J., 1946. Neue *Stigmella*-Arten (Lep., Stigmellidae). — Z. wien. ent. Ges. 31: 160—172.
- Klimesch, J., 1948. Zur Frage der verwantschaftliche Beziehungen einiger *Stigmella*-Arten auf Grund des Baues des männl. Kopulationsapparates. (Lep., Stigmellidae). — Z. wien. ent. Ges. 33: 49—82.
- Klimesch, J., 1950. Über einige Nahrungsrassen von



- Nepticula*-Arten (Lep., Nepticulidae). — Ent. NachrBl., Wien 2: 25—28, 49—51, 72—74, 89, 90.
- Klimesch, J., 1951. Contributo alla fauna Lepidotterologica del Trentino. — Studi trent. Sci. nat. 27: 11—68.
- Klimesch, J., 1953. Die europäischen *Trifurcula*- und *Ectoedemia*-Arten (Lep., Nepticulidae). — Z. wien. ent. Ges. 38: 160—170, 191—196.
- Klimesch, J., 1961. Ordnung Lepidoptera. I. Teil: Pyralidina, Tortricina, Tineina, Eriocraniina und Micropterygina. — In: H. Franz, Die Nordost-Alpen im Spiegel ihrer Landtierwelt, 2: 481—789. Universitätsverlag Wagner, Innsbruck.
- Klimesch, J., 1975a. Ergebnisse von Untersuchungen einiger Nepticuliden-Typen der Sammlung des Muséum national d'Histoire naturelle, Paris (Lep., Nepticulidae). — Bull. Mus. natn Hist. nat., Paris 3e ser., no. 314, Zool. 221: 861—866.
- Klimesch, J., 1975b. Über neue mediterrane und kanarische Nepticuliden. — Mitt. münch. ent. Ges. 65: 1—28.
- Klimesch, J., 1975c. Die an Ulmen lebenden europäischen Nepticuliden-Arten (Lepidoptera: Nepticulidae). — Opusc. Zool. 135: 1—15.
- Klimesch, J., 1978. Beitrag zur Kenntnis der Nepticulidenfauna von Anatolien und der Insel Rhodos (Lepidoptera, Nepticulidae). — Tijdschr. ent. 121: 239—278.
- Kristensen, N. P., 1970. Morphological observations on the wing scales in some primitive Lepidoptera (Insecta). — J. Ultrastruct. Res. 30: 402—410.
- Kristensen, N. P. & E. S. Nielsen, 1980. The ventral diaphragm of primitive (non-ditrysian) Lepidoptera. A morphological and phylogenetic study. — Z. Zool. Syst. EvolFors. 18: 123—146.
- Kyrki, J. & J. Tabell, 1984. Lisayksia Suomen luonnontieteellisten maakuntien pikkuperhoslajistoon (Lepidoptera: Micropterigidae — Pterophoridae). — Notul. ent. 64: 134—144.
- Larsen, K., 1981. To for den danske fauna nye småsommerfugle: *Trifurcula amani* (Svensson, 1966) og *Phyllonorycter platani* (Staudinger, 1870) (Lepidoptera). — Ent. Meddr 49: 71—75.
- Leraut, P., 1977. Quatre Lépidoptères à ajouter à la faune de France (Gracillariidae, Nepticulidae). — Bull. Soc. Lépidoptéristes fr. 1(2): 91—92.
- Leraut, P., 1980. Liste systématique et synonymique des Lépidoptères de France, Belgique et Corse. — Supplément à Alexanor et au Bull. Soc. ent. Fr.: 1—334.
- Lhomme, L., 1945. Deux espèces nouvelles pour la faune française *Phlyctaenodes ustrinalis* Schris. (Pyraustinae) et *Stigmella* (*Nepticula*) *mahalebella* Klim. (Stigmellina). — Revue fr. Lépidopt. 10: 155, 156.
- Lhomme, L., [1963]. Catalogue des Lépidoptères de France et de Belgique 2.(2), Microlépidoptères: 1164—1210.
- Lindner, E., 1959. Über das Vorkommen von *Ectoedemia liebwerdella* Zimm. in Westdeutschland (Lepidoptera, Nepticulidae). — Mitt. Dt. ent. Ges., e.v., 18: 7, 8.
- Lindquist, O. H., 1962. A biological study of a new leaf miner on Birch, *Nepticula lindquisti* Freeman (Lepidoptera: Nepticulidae), in Ontario. — Can. Ent. 94: 524—530.
- Linnaeus, C., 1767. Systema naturae. Tomus I. Edition decima tertia, ad Editionem duodecimam reformatam Holmiensem. — Vindobonae, Typis Ioannis Thomae nob. de Trattnern.
- Marchand, S. le, 1946. *Stigmella prinophyllella* n. sp. Microlépidoptères, Stigmellidae). — Revue fr. Lépidopt. 10: 280—289.
- Marchand, S. le, 1948. *Stigmella* (*Nepticula*) *prinophyllella* Le Md. est synonyme de *Nepticula baraldi* Soffner. — Revue fr. Lépidopt. 11: 298, 299.
- Mariani, M., 1939. Un nuovo genere e due nuove specie di Lepidotteri di Sicilia. — G. Sci. nat. econ. Palermo, 40(17): 1—7, 1 pl.
- Meess, A., 1910. Superfam. Tineides aculeatae. — In: A. Spuler (ed.), Die Schmetterlinge Europas, 2: 464—482; 3: pl. 91. Schweizerbart'sche Verlagbuchhandlung, Stuttgart.
- Mendes, C. 1910. Lithocolletes et Nepticulae novae ex Lusitania. — Broteria 9: 163—166, pl. 7.
- Menken, S. B. J., in preparation. Biochemical systematics and phylogeny in the leafminer genus *Ectoedemia* Busck (Lepidoptera: Nepticulidae).
- Meyrick, E., 1877. Larva of *Nepticula quinquella*. — Entomologist's mon. Mag. 14: 111, 112.
- Meyrick, E., 1895. A handbook of British Lepidoptera. — London, Macmillan & Co.
- Meyrick, E., 1928. A revised handbook of British Lepidoptera. — Watkins & Doncaster, London.
- Nemeş, I., 1970. *Stigmella* (*Fomoria*) *niculescui* nova species (Lep. Stigmellidae). — Bull. Soc. ent. Mulhouse 1970: 33—35.
- Nemeş, I., 1972. *Stigmella* (*Fomoria*) *peiuii* nova species (Lepidoptera, Stigmellidae). — Studii Comun. Muz. Stiint. nat. Bacau. 5: 153—156.
- Nielsen, E. S. 1980. A cladistic analysis of the Holarctic genera of adelid moths (Lepidoptera: Incurvaroidea). — Ent. scand. 11: 161—178.
- Nieukerken, E. J. van, 1982. New and rare Nepticulidae in the Netherlands (Lepidoptera). — Ent. Ber., Amst. 42: 104—112.
- Nieukerken, E. J. van, 1983. The Cistaceae-feeding Nepticulidae (Lepidoptera) of the western Palaearctic region. — Syst. Ent. 8: 453—478.
- Nieukerken, E. J. van, in preparation. Revision and phylogeny of holarctic genera of Nepticulidae (Lepidoptera).
- Nieukerken, E. J. van, in press. A provisional phylogenetic check-list of the western palaearctic Nepticulidae, with data on hostplants (Lepidoptera). — Ent. scand. 17.
- Nieukerken, E. J. van & H. Dop, in preparation. Antennal sensory structures in Nepticulidae (Lepidoptera) and phylogenetic implications.

- Nieukerken, E. J. van & R. Jansen, in preparation. Morphology and systematics of larvae of palaearctic Nepticulidae (Lepidoptera).
- Nolcken, J. H. W. Baron, 1871. Lepidopterologische Fauna von Estland, Livland und Kurland. Zweite Abtheilung, Microlepidoptera, 2. Heft: I—VIII, 1—849, errata.
- Petersen, W., 1930. Die Blattminierer-Gattungen *Lithocolletis* und *Nepticula* (Lep.). Teil II: *Nepticula* Z. — Stett. ent. Ztg 91: 1—82, 3 pls.
- Povolný, D. & F. Gregor, 1952. Pátý příspěvek k fauně Motýlů čsr. — Čas. čsl. Spol. ent. 49: 237—239.
- Puplesis, R. K. (Pupljasis), 1984a. Nove vedy Molejmaljutok (Lepidoptera, Nepticulidae) iz južnogo Primor'ja. — Ent. Obozr. 63: 111—125.
- Puplesis, R. K., 1984b. K sisteme molejmaljutok (Lepidoptera, Nepticulidae) palearktičeskoj fauny. — Ent. Obozr. 63: 582—597.
- Rebel, H., 1901. — In: Staudinger, O. & H. Rebel, Catalog der Lepidopteren des Palaearctischen Faunengebietes. Berlin, Friedländer & Sohn.
- Robinson, G. S., 1976. The preparation of slides of Lepidoptera genitalia with special reference to the Microlepidoptera. — Entomologist's Gaz., 27: 127—132.
- Robinson, G. S. & E. S. Nielsen, 1983. The Microlepidoptera described by Linnaeus and Clerck. — Syst. Ent., 8: 191—242.
- Rössler, A., 1866. Verzeichniss der Schmetterlinge des Herzogthums Nassau. — Jb. nassau. Ver. Naturk. 19 + 20: 99—442.
- Rössler, A., 1881. Die Schuppenflügler (Lepidopteren) des Kgl. Regierungsbezirks Wiesbaden und ihre Entwicklungsgeschichte. — Jb. nassau. Ver. Naturk. 33 + 34: 1—392.
- Saether, D. A., 1979. Underlying synapomorphies and anagenetic analysis. — Zool. Scr. 8: 305—312.
- Sauber, A., 1904. Die Kleinschmetterlinge Hamburgs und der Umgegend. — Verh. Ver. naturw. Unterh. Hamb. 12: 1—60.
- Schönherr, J., 1958. Biologie und Morphologie von *Ectoedemia liebwerdella* Zimmerm., unter Berücksichtigung der übrigen rindenminierenden Nepticuliden (Lep.). — Dt. ent. Z. (N.F.) 5: 1—71.
- Scoble, M. J., 1978. Nepticulidae (Lepidoptera) of southern Africa: the genus *Ectoedemia* Busck. — J. ent. Soc. sth. Afr. 41: 81—86.
- Scoble, M. J., 1979. A new species of *Ectoedemia* Busck from Botswana with observations on its imaginal skeletal anatomy (Lepidoptera: Nepticulidae). — Ann. Transv. Mus. 32: 35—54.
- Scoble, M. J., 1983. A revised cladistic classification of the Nepticulidae (Lepidoptera) with descriptions of new taxa mainly from South Africa. — Transv. Mus. Monograph. 2: i—xi, 1—105.
- Skala, H., 1933. Neue Neptikel. — Z. öst. EntVer. 18: 30—32.
- Skala, H., 1940. In der Welser Heide beobachtete Falter. — Z. wien. EntVer. 25: 143, 144, 159, 160, 179, 180, 186—188, 211.
- Skala, H., 1941. Neues über Miner. — Z. wien. EntVer. 26: 55—57, 77—80, 123—125, pls. ii—iv.
- Skala, H., 1942. Falter von Haid und anderes. — Z. wien. EntVer. 27: 5—7.
- Skala, H., 1948. Zur Familie der Miner (Nepticulidae). — Z. wien. EntVer. 32: 121, 122.
- Snellen, P. C. T., 1882. De vlinders van Nederland. Microlepidoptera, systematisch beschreven, 2 vols. — E. J. Brill, Leiden.
- Soffner, 1942. Eine neue *Nepticula* Art. — Mitt. Dt. ent. Ges. 11: 56—61.
- Sorhagen, L., 1886. Die Kleinschmetterlinge der Mark Brandenburg und einiger angrenzenden Landschaften. Mit besonderer Berücksichtigung der Berliner Arten. — R. Friedländer & Sohn, Berlin.
- Sorhagen, L., 1922. Beiträge zur Biologie Europäischer *Nepticula*-Arten. — Arch. Naturgesch., 88A: 9—60, 4 pls.
- Stainton, H. T., 1849. An attempt at a systematic catalogue of the British Tineidae & Pterophoridae. — John van Voorst, London.
- Stainton, H. T., 1851. A supplementary catalogue of the British Tineidae & Pterophoridae. — John van Voorst, London.
- Stainton, H. T., 1854. Insecta Britannica. Lepidoptera: Tineina. — Lovell Reeve, London.
- Stainton, H. T., 1855. The natural history of the Tineina, 1. — John van Voorst, London.
- Stainton, H. T., 1857. Lepidoptera. New British species in 1856. — Entomologist's Annu. 1857: 97—112.
- Stainton, H. T., 1858. Lepidoptera. New British species in 1857. — Entomologist's Annu. 1858: 85—98.
- Stainton, H. T., 1859. Manual of British Butterflies and Moths, 2. — Cooke & Son, London.
- Stainton, H. T., 1862. The Natural History of the Tineina, 7. — John van Voorst, London.
- Stainton, H. T., 1869. Tineina observed at Cannes and Mentone in February and March 1867. — In: H. T. Stainton (ed.). The Tineina of Southern Europe: 216—232. John van Voorst, London.
- Stainton, H. T. 1886. *Nepticula argyropeza* and *apicella*. — Entomologist's mon. Mag. 26: 237, 238.
- Stainton, H. T., 1887. A new species of *Nepticula* bred from birch, from Herefordshire (*N. Woolhopiella*). — Entomologist's mon. Mag. 24: 62.
- Stephens, J. F., 1829. A systematic catalogue of British Insects, part 2. — London, Baldwin and Cradock.
- Stephens, J. F., 1834. Illustrations of British Entomology, Haustellata IV: 1—433, pls. 33—41. — London, Baldwin and Cradock.
- Studel, W. & E. Hofmann, 1882. Verzeichniss württembergischer Kleinschmetterlinge. — Jh. Ver. vaterl. Naturk. Württ. 38: 143—262.
- Svensson, I., 1966. New and confused species of Microlepidoptera. — Opusc. ent. 31: 183—202.
- Szöcs, J., 1957. New *Nepticula* species from Hungary. — Annl. hist.-nat. Mus. natn hung. (nov. Ser.) 8: 321—323.

- Szöcs, J., 1965. Microlepidoptera I, Nepticulidae. — Fauna Hung. 76: 48—104.
- Szöcs, J., 1968. Some unknown data concerning miners (Lepidoptera). — Acta zool. hung. 14: 225—231.
- Szöcs, J., 1978. Adatok a Pilis-hegység aknázómoly faunájához. (Data to the mining moths fauna from the Pilis Mts.) — Folia ent. hung, s.n., 31: 265—271.
- Szöcs, J., 1981. Angaben über die minierenden Motten aus Budapest und Umgebung. — Folia ent. hung., 42: 209—220.
- Tengström, J. M. J., 1848. Bidrag till Finlands Fjäril-Fauna. — Notis. Sällsk. Faun. Fl. fenn. Förh. 1: 69—164.
- Thunberg, C. P., 1794. D. D. Dissertatio entomologica sistens Insecta Suecica, 7: 83—98. — Upsaliae, Litteris Joh. Fred. Edman.
- Toll, S., 1934a. *Nepticula heringi* Sp. nova. — Annl. zool., Warsz. 11: 1—3.
- Toll, S., 1934b. Jeszcze o krajowych gatunkach rodzaju *Nepticula* Zell. (Noch über die heimischen Arten der Gattung *Nepticula* Zell.). — Polskie Pismo ent. 13: 61—84.
- Toll, S., 1936. Untersuchung der Genitalien bei *Pyr-rausta purpuralis* L. und *P. ostrinalis* Hb., nebst Beschreibung 11 neuer Microlepidopteren-Arten. — Annl. zool. Warsz. 11: 403—413, pls. 47—49.
- Treitschke, F., 1833. Die Schmetterlinge von Europa, 9 (2): 1—294. — Fleischer, Leipzig.
- Tutin, T. G., V. H. Heywood, N. A. Burges, D. H. Valentine, S. M. Walters & D. A. Webb (eds), 1964. Flora Europaea, 1. Lycopodiaceae to Platanaceae. — University Press, Cambridge.
- Tutin, T. G., V. H. Heywood, N. A. Burges, D. H. Valentine, S. M. Walters & D. A. Webb (eds), 1968. Flora Europaea, 2. Rosaceae to Umbelliferae. — University Press, Cambridge.
- Tutt, J. W., 1899. Natural History of the British Lepidoptera. A textbook for Students and Collectors, 1. — London-Berlin.
- Vári, L., 1950. Nederlandse Lepidoptera. (5e Faunistische Mededeling). — Ent. Ber., Amst. 13: 180—184.
- Vári, L., 1951. Nederlandse Lepidoptera (5e Faunistische Mededeling) (slot). — Ent. Ber., Amst. 13: 193—198.
- Walsingham, L., 1891. Micro-Lepidoptera collected near Cannes, 1890. — Entomologist's mon. Mag. 27: 137—152.
- Waters, E. G. R., 1928. *Nepticula albifasciella* Hein. : its early stages and its occurrence in Britain. — Entomologist's mon. Mag. 64: 248—251.
- Weber, P., 1937a. Über Mikrolepidopteren. — Beschreibung neuer Arten und Formen aus der Schweiz, sowie Angaben über weniger bekannte Arten. — Mitt. Schweiz. ent. Ges. 16: 666—672.
- Weber, P., 1937b. Zwei neue Arten der Mikrolepidopteren-gattung *Nepticula* und ein Beitrag zur Kenntnis von *Nepticula stelviana* Wck. — Mitt. Schweiz. ent. Ges. 17: 211—215.
- Wiley, E. O., 1981. Phylogenetics. — Wiley & Sons, New York.
- Wilkinson, C., 1981. A supplement to the genus *Ectoedemia* Busck (Nepticulidae: Lepidoptera) in North America, dealing with some difficult species and also some new ones. — Tijdschr. Ent. 124: 93—110.
- Wilkinson, C., G. Bryan, S. B. J. Menken & E. J. van Nieukerken, 1983. A clarification of the status of four taxa in the *Ectoedemia angulifasciella* group (Nepticulidae: Lepidoptera). — Neth. J. Zool. 33: 211—224.
- Wilkinson, C. & P. J. Newton, 1981. The microlepidopteran genus *Ectoedemia* Busck (Nepticulidae) in North America. — Tijdschr. Ent. 124: 27—92.
- Wilkinson, C. & M. J. Scoble, 1979. The Nepticulidae (Lepidoptera) of Canada. — Mem. ent. Soc. Can. 107: 1—118.
- Wocke, M. F., 1860. Mittheilungen über einige für die schlesische Fauna neue Arten. — Jber. schles. Ges. vaterl. Kult. 38: 132, 133.
- Wocke, M. F., 1861. Microlepidoptera. — In: O. Staudinger & M. Wocke. Catalogue des Lépidoptères d'Europe et des pays limithrophes: 85—130. — Dresden.
- Wocke, M. F., 1865. Zwei neue Nepticulen. — Stett. ent. Ztg 26: 269, 270.
- Wocke, M. F., 1871. Catalog der Lepidopteren des europäischen Faunengebiets, 2. Microlepidoptera.
- Wocke, M. F., 1874. Verzeichniss der Falter Schlesiens, 2. Microlepidoptera. — Z. Ent., N. F. 4: 1—107.
- Zeller, P. C., 1839. Versuch einer naturgemässen Einteilung der Schaben. — Isis, Jena 1839: 167—220.
- Zeller, P. C., 1848. Die Gattungen der mit Augendeckeln versehenen blatminirenden Schaben. — Linn. ent. 3: 248—344.
- Zerkowitz, A., 1946. The Lepidoptera of Portugal. — J. N.Y. ent. Soc. 54: 51—87, 115—165, 211—261.
- Zetterstedt, J. W., 1839. Insecta Lapponica descripta, 1010—1011. — Lipsiae.
- Zimmermann, F., 1940. Eine neue Nepticulide aus Deutschland (Lep.), *Ectoedemia liebwerdella* spec. nov. (Lep.). — Mitt. zool. Mus. Berlin 24: 264, 265.
- Zimmermann, F., 1944. Zur Kenntnis der Verbreitung der Nepticuliden in den Reichsgauen Wien und Niederdonau (Lepidopt.). — Z. wien. ent. Ges. 29: 3—6, 60—64, 78—91, 107—122.



## Index to (sub)genera and species treated

Reference to the first page of the treatment of each species is given only. Synonyms are given in italics, unavailable names provided with a double dagger (‡) and misidentifications are cited in square brackets.

	Ectoedemia	8, 27
	erythrogenella	64
	gilvella	82
	gilvipennella	45
	hannoverella	30
	haraldi	47
	heringella	49
	heringi	59
	<i>heringiella</i>	18
	hexapetalae	68
	hispanica	22
	‡ <i>houzeaui</i>	35
	‡ <i>ilicella</i>	47
	ilicis	48
	intimella	28
	‡ <i>juncta</i>	64
	klimeschi	33
	leucothorax	46
	liebwerdella	20
	liechtensteini	61
	liguricella	25
	lindquisti	79
	longicaudella	21
	mahalebella	77
	‡ <i>malivora</i>	71
	<i>marionella</i>	31
	<i>mediofasciella</i>	78
	[ <i>mediofasciella</i> sensu Bradley]	80
	minimella	80
	<i>minorella</i>	69
	monemvasiae	23
	<i>montissancti</i>	54
	‡ <i>morosella</i>	35
	<i>muclidella</i>	78
	<i>niculescui</i>	33
	<i>nigrociliella</i>	57
	nigrosarsella	51
	nuristanica	25
	occultella	78
	occultella-group	78
	<i>peiuui</i>	21
	phyllotomella	62
	populella	28
	populella-group	28
aegilopidella	42	
<i>agrimomella</i>	66	
agrimoniae	66	
<i>agrimoniella</i>	66	
albifasciella	52	
albifasciella-complex	52	
algeriensis	44	
algeriensis, cf	45	
‡ <i>alliatae</i>	49	
alnifoliae	50	
amani	24	
andalusiae	41	
angulifasciella	69	
<i>angulifasciella</i> partim	71	
angulifasciella-complex	69	
angulifasciella-group	63	
<i>apicella</i>	35	
<i>arcuata</i>	73	
arcuatella	73	
<i>arcuatella</i> partim	74	
<i>arcuosella</i>	73	
<i>argentipedella</i>	78	
<i>argentipedella</i> partim	80	
<i>argyropeza</i> Herrich-Schäffer	31	
<i>argyropeza</i> Zeller	35	
[ <i>argyropeza</i> sensu Beirne]	52	
[ <i>argyropeza</i> sensu Petersen]	34	
[ <i>argyropeza</i> sensu Stainton]	52	
<i>argyropezella</i> Doubleday	35	
<i>argyropezella</i> Herrich-Schäffer	31	
<i>aterrima</i>	71	
‡ <i>aterrimoides</i>	71	
<i>atricolella</i>	71	
atricollis	71	
atrifrontella	18	
bistrimaculella	82	
<i>brunniella</i>	69	
caradjai	38	
<i>castaneae</i> -group	17	
cerris	54	
contorta	55	
<i>cursoriella</i>	57	
<i>Dechtiria</i>	27	

<i>populi-albae</i>	31	<i>staphyleae</i>	71
<i>preisseckeri</i>	37	<i>strigilella</i>	78
<i>preisseckeri</i> -group	37	<i>subapicella</i>	52
<i>prinophyllella</i>	47	subbimaculella	57
‡ <i>prunivora</i>	71	subbimaculella-complex	56
<i>pubescivora</i>	55	subbimaculella-group	43
		suberis	40
<i>quercifoliae</i>	59	suberis-group	38
<i>quinquella</i>	43		
		terebinthivora	63
<i>rubivora</i>	74	terebinthivora-group	63
[ <i>rubivora</i> sensu Walsingham]	64	<i>Trifurcula</i> partim	27
		<i>turbidella</i> Herrich-Schäffer	35
<i>sativella</i>	59	<i>turbidella</i> Zeller	31
<i>schleichiella</i>	69	<i>turbulentella</i>	35
<i>simplicella</i>	35		
"species" (specimen 1843)	39	<i>utensis</i>	69
"species" (specimen 1375)	62		
"species" Gustafsson	50	<i>viridella</i>	40
"species" Klimesch	38	<i>viridicola</i>	80
"species" van Nieuwerkerken	55		
"species" Povolný & Gregor	65	<i>woolhopiella</i>	80
"species" Skala	54		
<i>spinosella</i>	75	<i>zimmermanni</i>	59
<i>spiraeae</i>	65	Zimmermannia	17
<i>spireae</i>	65		

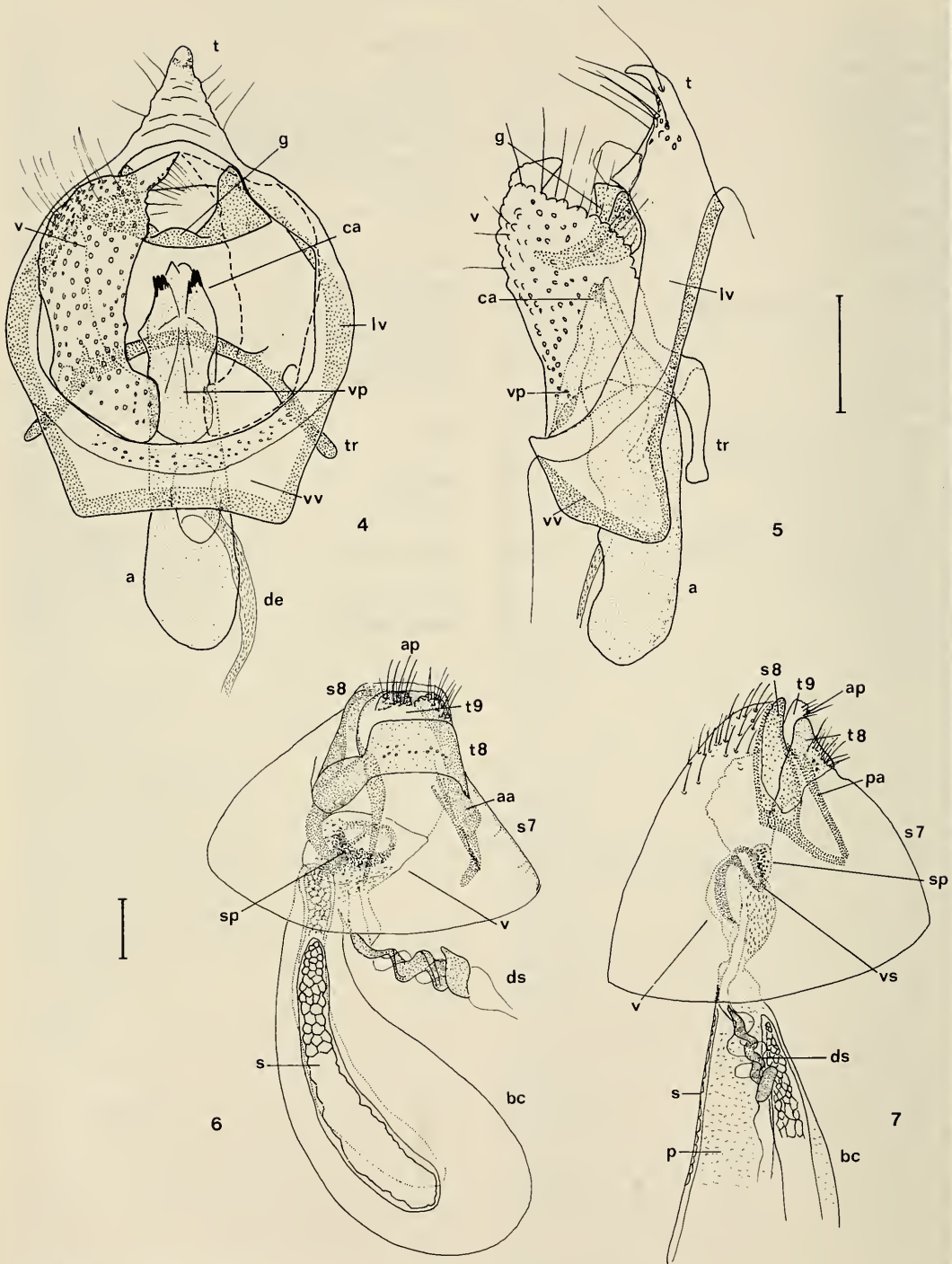

Figs. 4—7. Schematic diagrams of genitalia in *Ectoedemia* (s.str.). 4,5, ♂ genitalia, *E. occultella*; 4, ventral aspect; 5, lateral aspect. a = aedeagus; ca = carinae; de = ductus ejaculatorius; g = gnathos; lv = lateral arm of vinculum; t = tegumen; tr = transtilla; v = valva; vp = ventral process of aedeagus; vv = ventral plate of vinculum. 6, 7, ♀ genitalia. 6, *E. albifasciella*, ventral aspect; 7, *E. hannoverella*, lateral aspect. aa = anterior apophyses; ap = anal papillae; bc = bursa copulatrix; ds = ductus spermathecae; pa = posterior apophyses; s = signum; s7 = segment 7, s8 = sternite 8; sp = spiculate pouch; t8/9 = tergite 8/9; v = vestibulum; vs = vaginal sclerite. Scales: 0.1 mm.



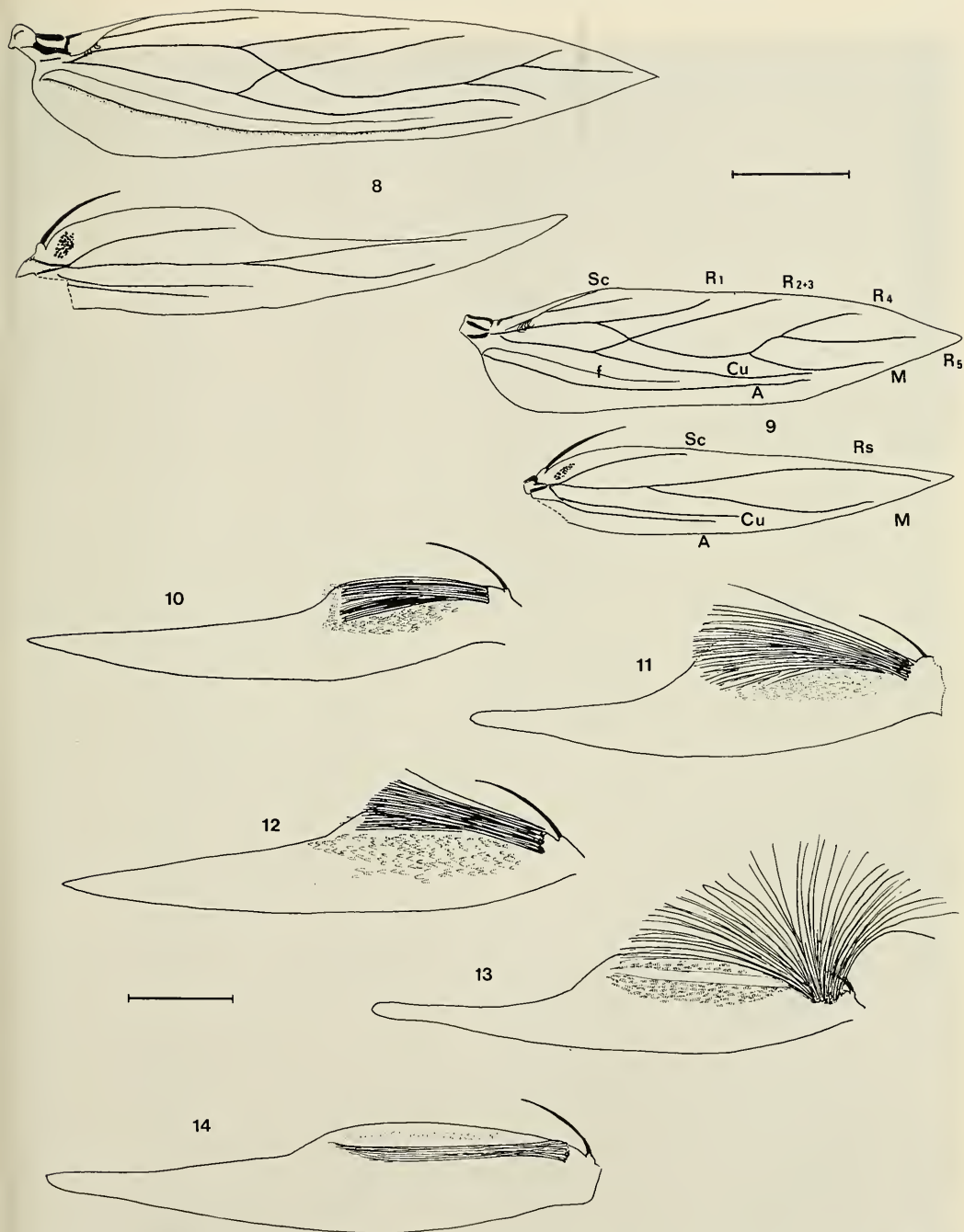

Figs. 8—9. Venation in *Ectoedemia*. 8, *E. (Zimmermannia) atrifrontella*, ♂, slide VU 252, Netherlands, Hilversum; 9, *E. (s.str.) intimella*, ♂, veins labelled, f = fold (no vein), slide VU 196, Netherlands, Schinveld. Figs. 10—14. Hindwings of *Ectoedemia (Zimmermannia)*, ♂, showing hair-pencil and surrounding special scales. Normal hindwing scales and fringe not drawn. 10, *E. atrifrontella*, Netherlands, Hilversum; 11, *E. liebwerdella*, East Germany, Tharandt; 12, *E. longicaudella*, Netherlands, Nijmegen; 13, *E. monemvasiae*, holotype, hair-pencil spread out; 14, *E. amani*, Sweden, Stockholm. Scales: 0.5 mm.

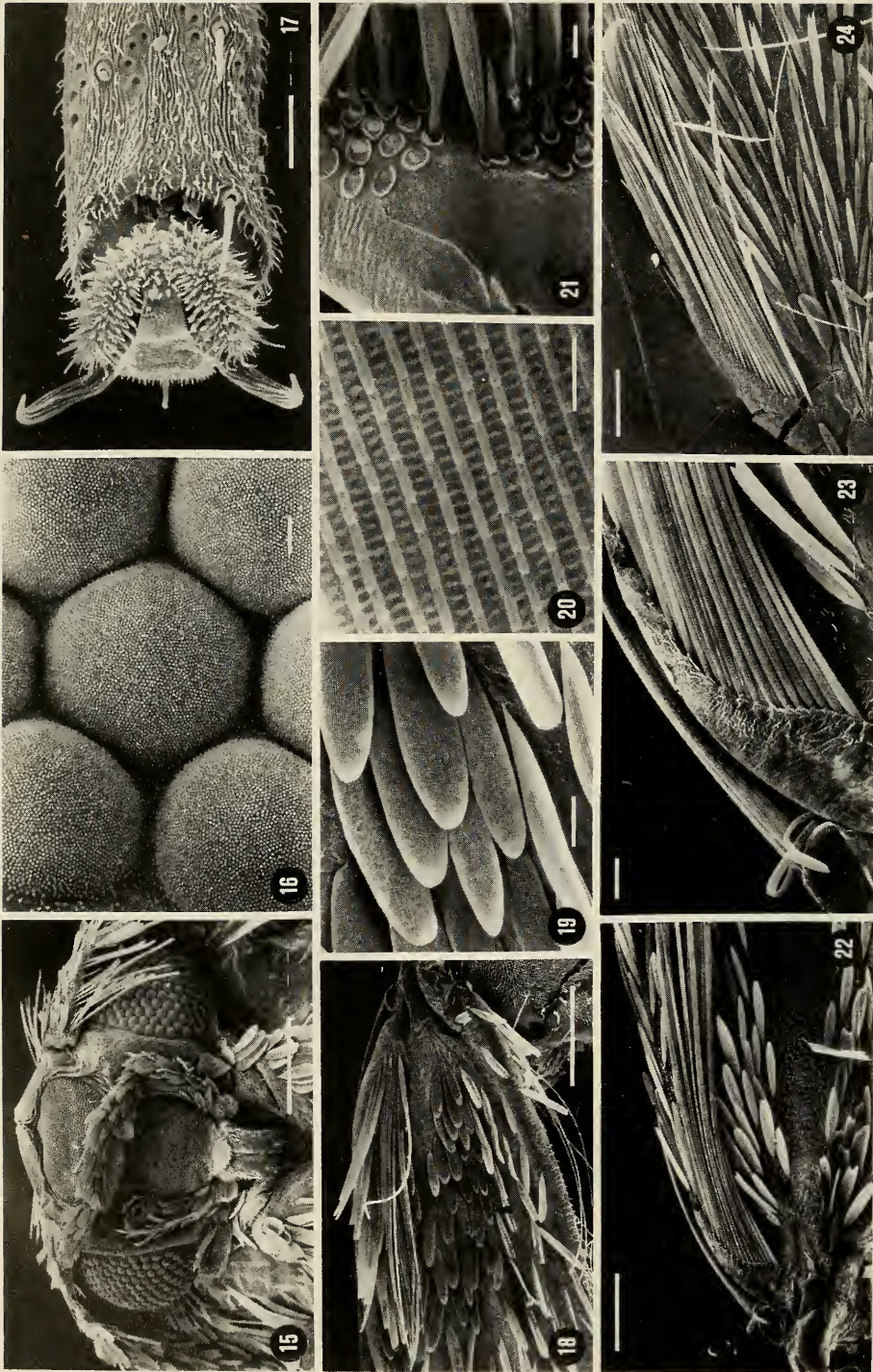

Figs. 15—17. Adult morphology of *Ectoedemia attricollis*. 15, Head, scales partly removed, frontal aspect; 16, Detail of compound eye; 17, Tarsal claws, ventral aspect. Figs. 18—24. Hindwing structures of *Ectoedemia*, dorsal aspects. 18, *E. spinosella*, with hair-pencil and special scales (arrows); 19, Idem, detail of special scales; 20, Detail of one scale from 19; 21, *E. (Zimmermannia) longicaudella*, sockets of hair-pencil scales; 22, *E. occultella*, hair-pencil; 23, Idem, detail; 24, *E. hannoverella*, hair-pencil. Scales, 15, 18, 22, 24: 100  $\mu$ m; 16: 2  $\mu$ m; 17, 19, 21: 10  $\mu$ m; 20: 1  $\mu$ m; 23: 20  $\mu$ m.



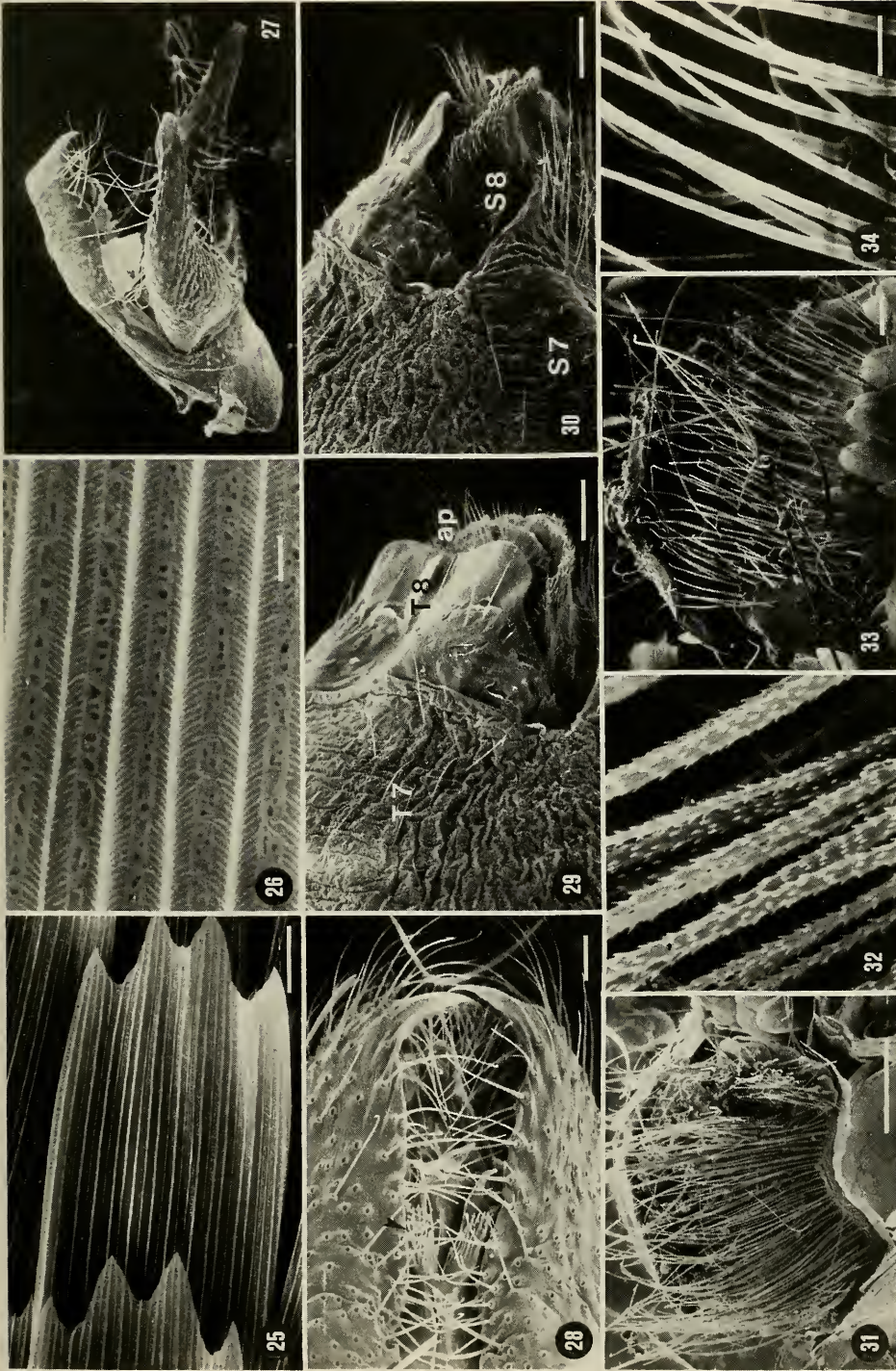

Figs. 25—26. *Ectoedemia occultella*, forewing scale structure. Figs. 27—28. *E. (Zimmermannia) longicaudella*, lateral aspect; 28, *E. atricollis*, ventral aspect with part of valvae and aedeagus, showing basal spines of carinae (arrow). Figs. 29—34. Female postabdomen. 29. *E. occultella*, dorsolateral aspect; 30, *Idem*, lateral aspect, ap = anal papillae (on tergite 9), s7 = sternite 7, s8 = sternite 8 (with spines), t7 = tergite 7, t8 = tergite 8; 31, *E. (Zimmermannia) monemvasiata*, dorsal aspect, showing long setae on t7/t8; 32, Detail of pectinate setae; 33, *E. (Zimmermannia) atrifrontella*, dorsal aspect; 34, Detail of smooth setae. Scales, 25: 10  $\mu$ m; 26: 1  $\mu$ m; 28, 33: 20  $\mu$ m; 29, 30: 50  $\mu$ m; 31: 100  $\mu$ m; 34: 5  $\mu$ m.



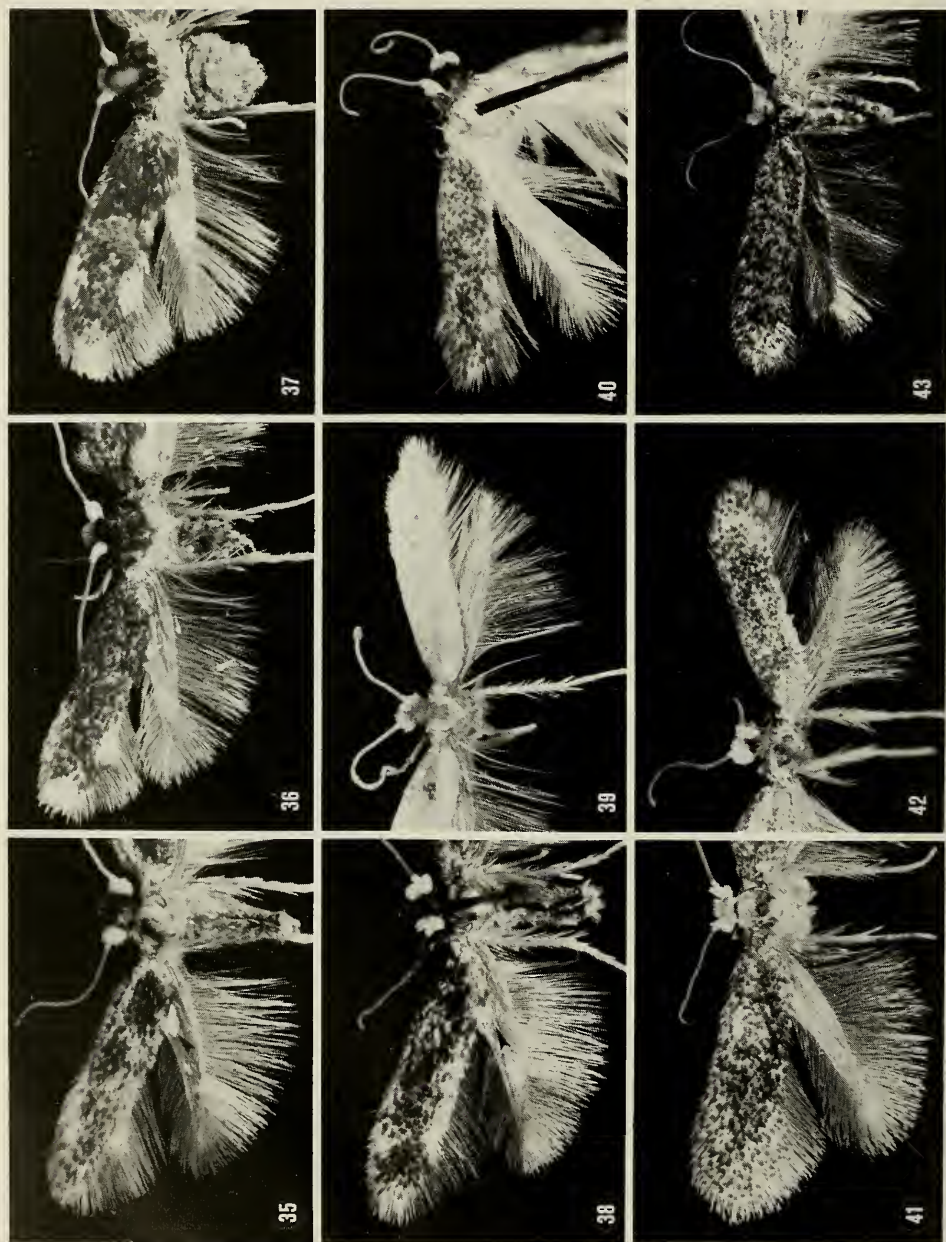

Figs. 35—43. *Ecioedemia* (*Zimmermannia*) spp. 35, *E. atrifrontella*, ♂, Netherlands, Hollandse Rading; 36, *E. liebwerdella*, ♂, East Germany, Tharandt; 37, *E. liebwerdella*, ♀, idem; 38, *E. longicaudella*, ♂, Sweden, Hogsby; 39, *E. hispanica*, ♂, holotype; 40, *E. monemvasiae*, ♀, paratype, Greece, Monemvasia; 41, *E. amani*, ♀, Sweden, Kullaberg; 42, *E. nursistanica*, ♂, holotype; 43, *E. liguricella*, ♂, Morocco, Oukaim'den. Arrows indicate specialised scales in males.

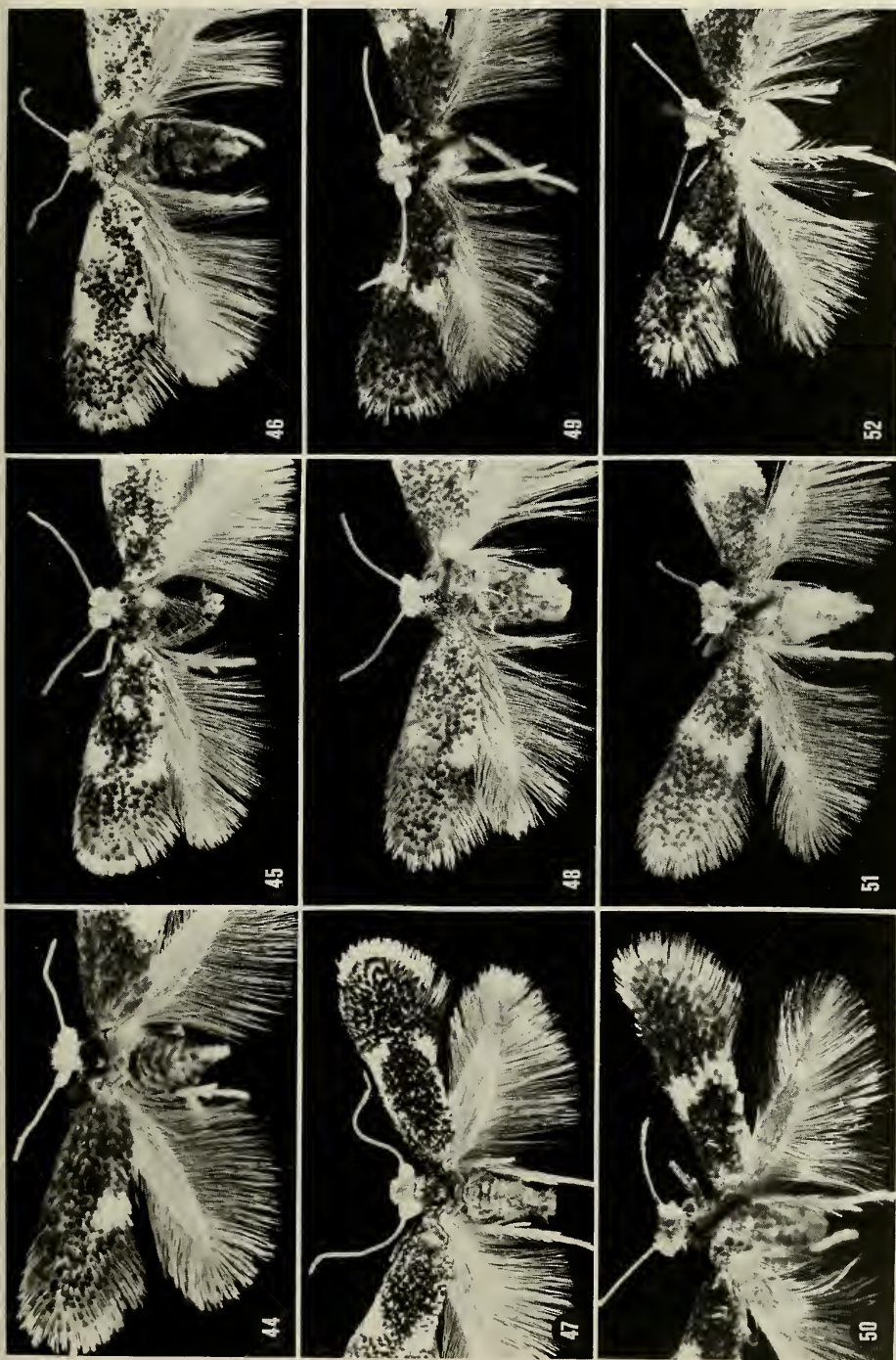

Figs. 44—52. *Ectoedemia* (s.str.) spp. 44, *E. inimella*, ♀, Netherlands, Ootmarsum; 45, *E. hannoverella*, ♂, Netherlands, De Lutte; 46, *E. turbidella*, ♀, Netherlands, Leiden; 47, *E. klimeschi*, ♂, Ausrtria, Wien; 48, *E. argyropeza*, ♀, Netherlands, Berg en Dal; 49, *E. preisseckeri*, ♂, lectotype; 50, *E. caradjai*, ♀, Hungary, Nagykovacs; 51, *E. suberis*, ♀, France, Cannes; 52, *E. andalusiae*, ♀, holotype.



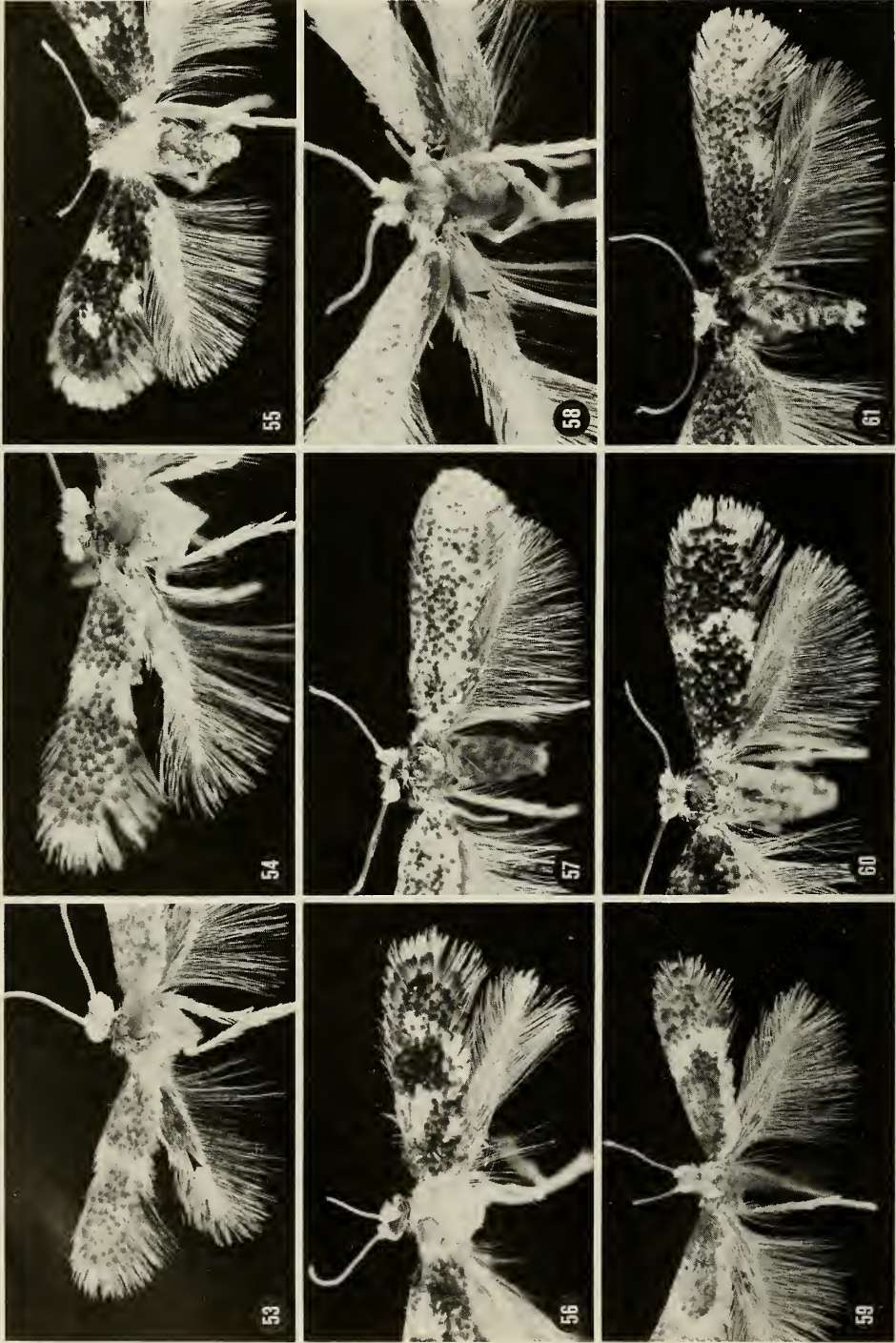

Figs. 53—61. *Ectoedemia* (s.str.) spp. 53, *E. aegilopidella*, ♂, special scales arrowed, paratype, Greece, Rhodos; 54, *E. aegilopidella*, ♀, paratype, idem; 55, *E. quinquella*, ♀, Great Britain, Herringswell; 56, *E. algeriensis*, ♀, holotype; 57, *E. gilvipennella*, ♂, Austria, Hof am Leithagebirge; 58, *E. gilvipennella*, ♂, detail showing black hair-pencil (arrow), Hungary, Törökbalint; 59, *E. leucothorax*, ♀ paratype, Spain, Marbella; 60, *E. haraldi*, ♀, Spain, N. Benahavis; 61, *E. ilicis*, ♂, Spain, Igualeja.



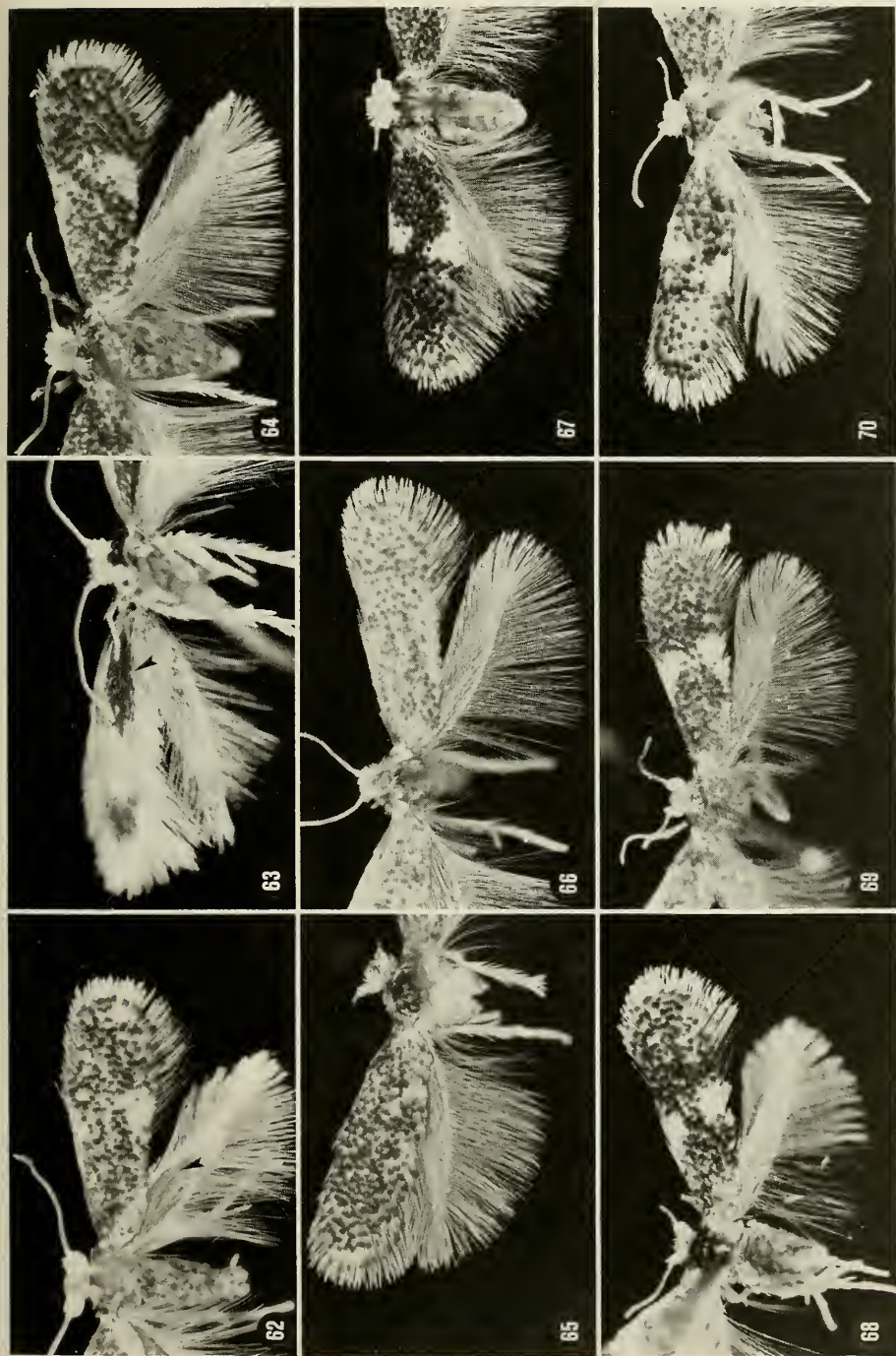

Figs. 62—70. *Ectoedemia* (s.str.) spp., *subbimaculella* group. 62—64, *E. beringella*, Yugoslavia, Rijeka; 62, ♂, upperside; 63, ♂, underside; 64, ♀; 65, *E. abnifoliae*, ♀, holotype; 66, *E. nigrosparsella*, ♀, Italy, Sardegna; 67, *E. albifasciella*, ♀, Netherlands, Wageningen; 68, *E. cerris*, ♀, Hungary, Szár; 69, *E. pubescivora*, ♀, Italy, Sardegna, Belvi; 70, *E. contorta*, ♀, holotype. Arrows in 62 and 63 indicate specialised scales.

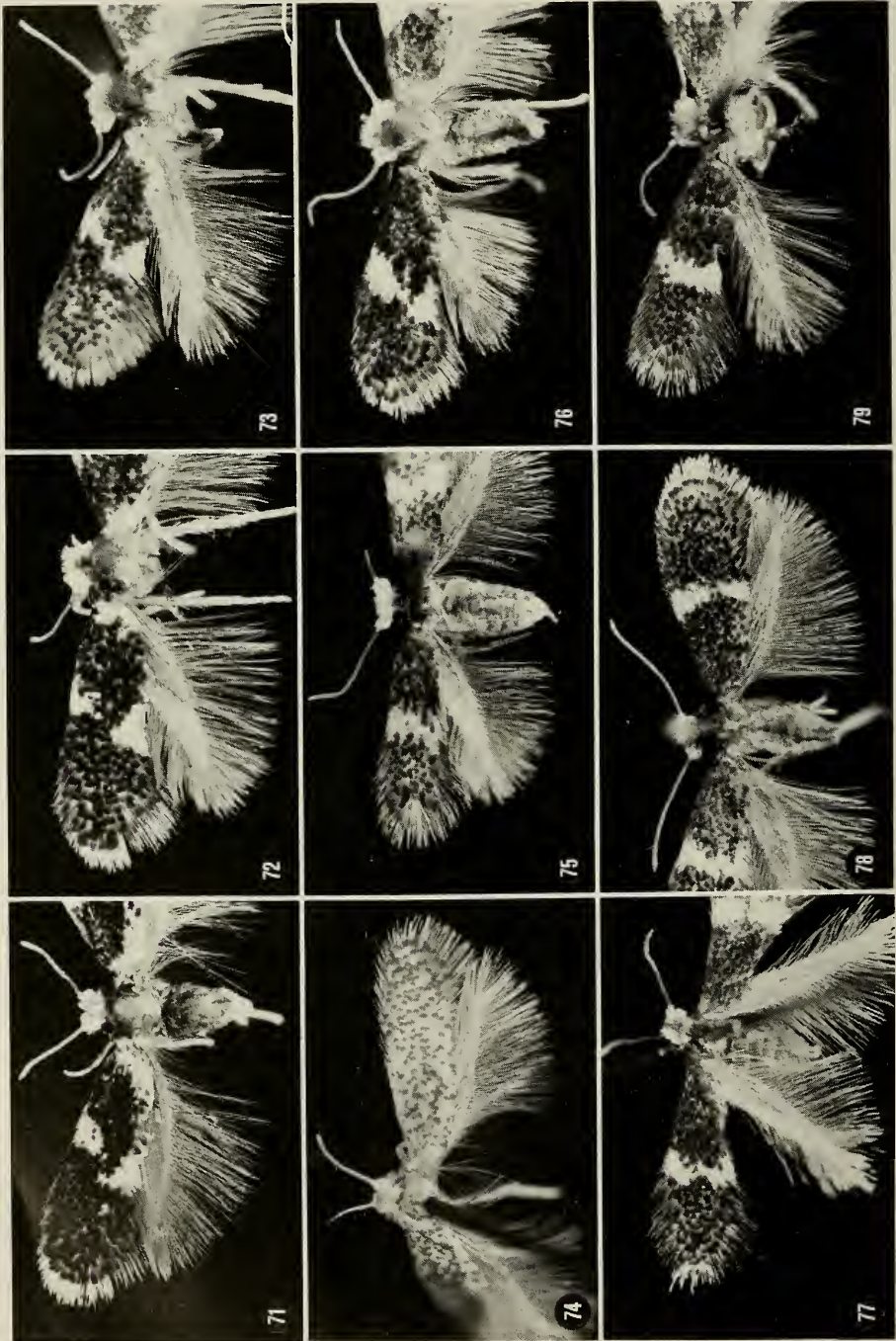

Figs. 71—79. *Ectoedemia* (s.str.) spp. 71, *E. subbimaculella*, ♀, Netherlands, Hoge Veluwe; 72, *E. heringi*, ♀, Austria, Hackelsberg; 73, *E. phylloiomella*, ♂, lectotype; 74, *E. spec.* (specimen 1375), ♀, Iran, Shiraz; 75, *E. terebinthivora*, ♀, Greece, Dhelfoi; 76, *E. erythrogenella*, ♂, England, Portland; 77, *E. spiraeae*, ♀, Czechoslovakia, Murán; 78, *E. agrimoniae*, ♂, Greece, Evvoia; 79, *E. hexapetalae*, ♀, Hungary, Budaörs.



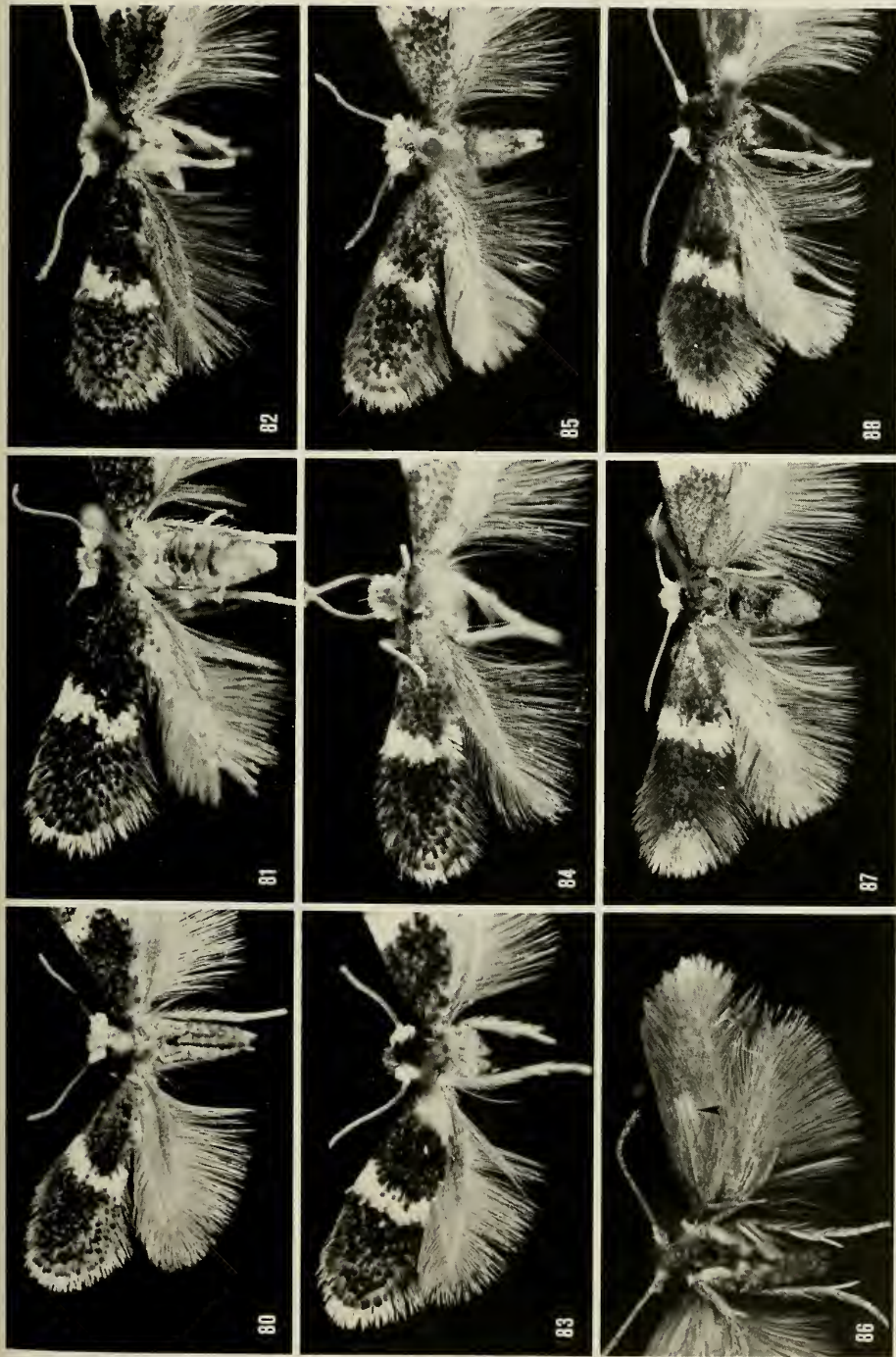

Figs. 80—88. *Ectoedemia* (s.str.) spp. 80, *E. angulifasciella*, ♂, Netherlands, Ootmarsum; 81, *E. atricollis*, ♀, Netherlands, breeding ex ovo; 82, *E. arcuatella*, ♂, Greece, Frangista; 83, *E. rubivora*, ♂, Netherlands, Winterswijk; 84, *E. spinosella*, ♀, Netherlands, Gulpen; 85, *E. mabalebella*, ♂, Italy, Trento; 86, *E. occultella*, ♂, underside, patch of white special scales arrowed, Germany-West, Alendorf; 87, *E. occultella*, ♀, Netherlands, Wageningen; 88, *E. mimimella*, ♂, Norway, Grøvuålen.





89



90



91



92



93



94

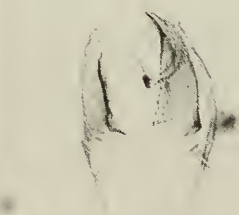

95



96



97

Figs. 89—97. *Ectoedemia* spp., ♂ genitalia (aedeagus removed in 93—95), ventral aspect. 89, *E. atrifrontella*, slide VU 087, Netherlands, Overveen; 90, *E. liebwerdella*, East Germany, Tharandt, slide on pin; 91, *E. longicaudella*, slide VU 1835, Anatolia, Kizilcahamam; 92, *E. hispanica*, slide VU 1931, holotype; 93, *E. monemvasiae*, slide VU 1834, paratype, Anatolia, Kizilcahamam; 94, *E. amani*, slide MV 5752, Austria, Hundsheimer Berg; 95, *E. nuristanica*, slide MV 5402, holotype; 96, *E. liguricella*, slide VU 1828, Spain, Sierra Alfacar; 97. *E. intimella*, slide VU 1213, Netherlands, Rockanje.

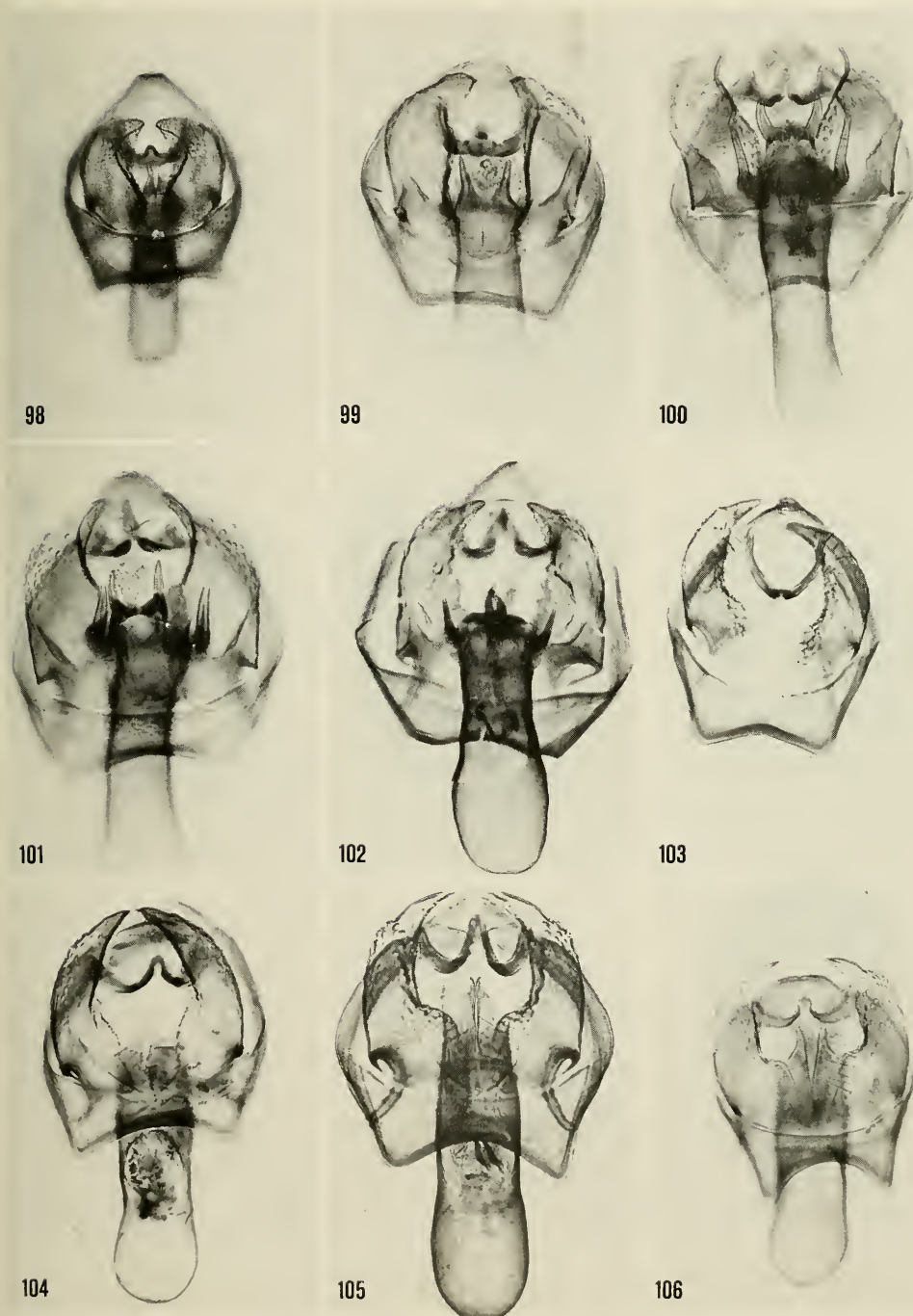

Figs. 98—106. *Ectoedemia* (s.str.) spp., ♂ genitalia, ventral aspect (aedeagus removed in 103). 98, *E. populella*, slide VU 1252, syntype, USA; 99, *E. hannoverella*, slide MV 12202, West Germany, Baiern; 100, *E. turbidella*, slide MV 12206, Austria, Linz; 101, *E. klimeschi*, slide VU 1230, Austria, Linz; 102, *E. preisseckeri*, slide MV 12218, Austria, Wien; 103, *E. caradjai*, slide VU 1382, Hungary, Csopak; 104, *E. spec.* (specimen 1843), slide VU 1843, Spain, Rubielos de Mora; 105, *E. suberis*, slide VU 1112, France, "Nesp."; 106, *E. andalusiae*, slide VU 1415, paratype, Spain, Camino de Ojen.



107



108



109



110



111



112



113



114

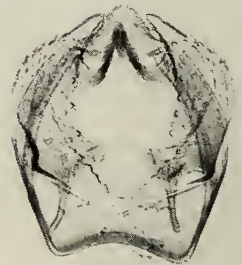

115

Figs. 107—115. *Ectoedemia* (s.str.) spp., ♂ genitalia, ventral aspect, aedeagus removed (except in 113). 107, *E. aegilopidella*, slide Klim. 1299, paratype, Greece, Rhodos; 108, *E. quinquella*, slide VU 869, England, Rainham; 109, *E. cf. algeriensis*, slide VU 1864, Morocco, Azrou; 110, *E. gulvipennella*, slide VU 1381, Hungary, Törökbálint; 111, *E. leucothorax*, slide VU 1885, paratype, Spain, Camino de Ojen; 112, *E. baraldi*, slide VU 868, paralectotype, France, Angoulême; 113, *E. ilicis*, slide VU 1420, Spain, Marbella; 114, *E. heringella*, slide VU 1395, Italy, Monti Aurunci; 115, *E. heringella*, slide RM 6666, Cyprus, Arakapos.





116



117



118



119



120



121



122



123



124

Figs. 116—124. *Ectoedemia* (s.str.) spp., ♂ genitalia, ventral aspect, aedeagus removed (except in 118, 120, 122). 116, *E. nigrosparsella*, slide VU 1378, Hungary, Törökbálint; 117, *E. albifasciella*, slide VU 864, Netherlands, Hilversum; 118, *E. cerris*, slide VU 1729, Hungary, Szár; 119, *E. pubescivora*, slide VU 1342, paralectotype, Switzerland, Somazzo; 120, *E. cf. contorta*, slide VU 909, Austria, Hundsheimer Berg; 121, *E. subbimaculella*, slide VU 863, Netherlands, Hilversum; 122, *E. heringi*, slide VU 1109, Poland, Bydgoszcz; 123, *E. heringi*, slide VU 867, paralectotype *N. zimmermanni*, Czechoslovakia, Libochowan; 124, *E. liechtensteini*, slide VU 1875, Hungary, Törökbálint.

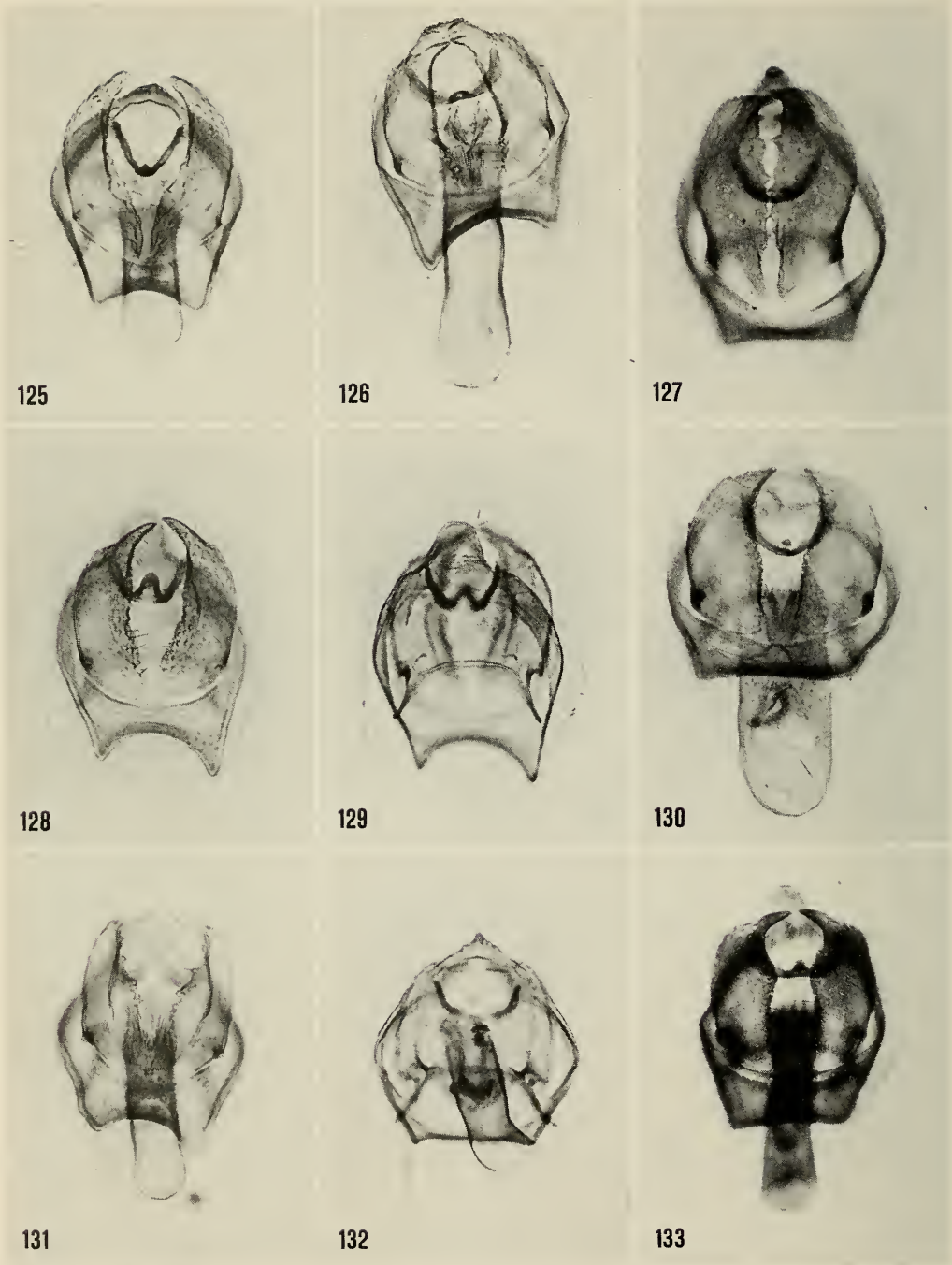

Figs. 125—133. *Ectoedemia* (s.str.) spp., ♂ genitalia, ventral aspect, aedeagus removed in 127—129. 125, *E. phyllotomella*, slide VU 1849, Italy, Mte Vulture; 126, *E. terebinthivora*, slide VU 1250, Greece, Dhelfoi; 127, *E. spiraeae*, slide VU 873, Hungary, Sástó; 128, 129, *E. erythrogenella*, slide VU 946, lectotype, 129 focussed on more dorsal part; 130, *E. hexapetalae*, slide VU 1739, Hungary, Budaörs; 131, *E. agrimoniae*, slide VU 642, Greece, Evvoia; 132, *E. agrimoniae*, slide MV 12186, East Germany, Potsdam (focussed more dorsally); 133, *E. angulifasciella*, slide MV 12180, Austria, Hundsheimer Berg.



134



135



136



137



138



139



140



141



142

Figs. 134—142. *Ectoedemia* (s.str.) spp., ♂ genitalia, ventral aspect. 134, *E. atricollis*, slide VU 1152, France, Clamart (from *Crataegus*); 135, *E. rubivora*, slide VU 1103, Denmark, Faaborg; 136, *E. arcuatella*, slide MV 12184, East Germany, Friedland; 137, 138, *E. spinosella*, slide VU 644, Greece, Arákhova (138 focussed more dorsally); 139, *E. occultella*, slide VU 1227, France, Pralognan; 140, 141, *E. mahalebella*, slide VU 997, Greece, Mt. Timfristos, (141 focussed more dorsally); 142, *E. minimella*, slide VU 1173, Norway, Rennebu.



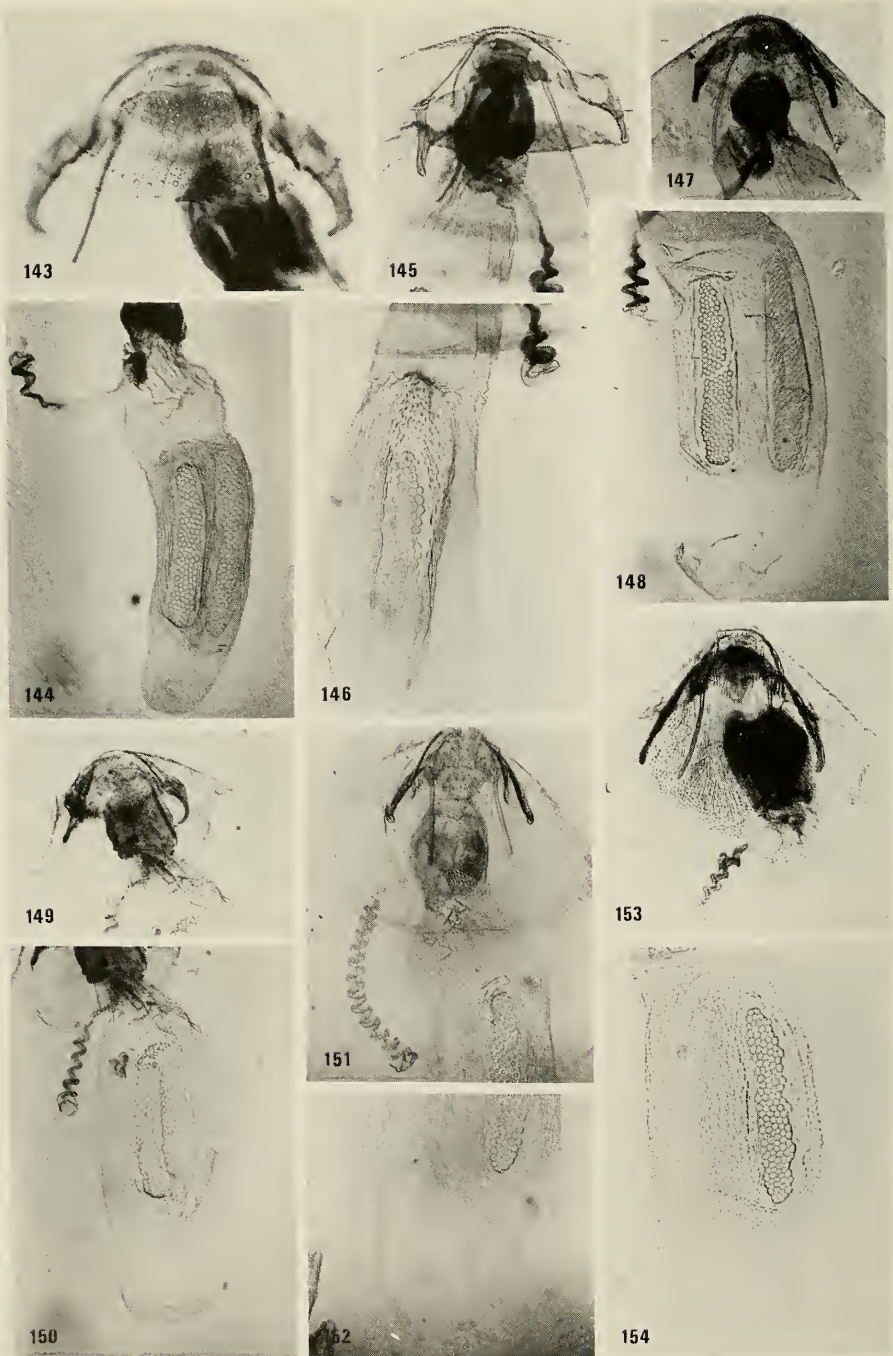

Figs. 143—154. *Ectoedemia* (*Zimmermannia*) spp., ♀ genitalia. 143, *E. atrifrontella*, abdominal tip, slide VU 496, Netherlands, Nijmegen; 144, idem, bursa, slide VU 483, Netherlands, Hilversum; 145, 146, *E. liebwerdella*, slide VU 1873, East Germany, Tharandt; 147, 148, *E. longicaudella*, slide VU 860, Belgium, Aye; 149, 150, *E. monemvasiae*, slide VU 486, paratype, Greece, Monemvasia; 151, 152, *E. amani*, slide VU 918, Sweden, Kulalberg; 153, 154, *E. nuristanica*, slide MV 12141, paratype.

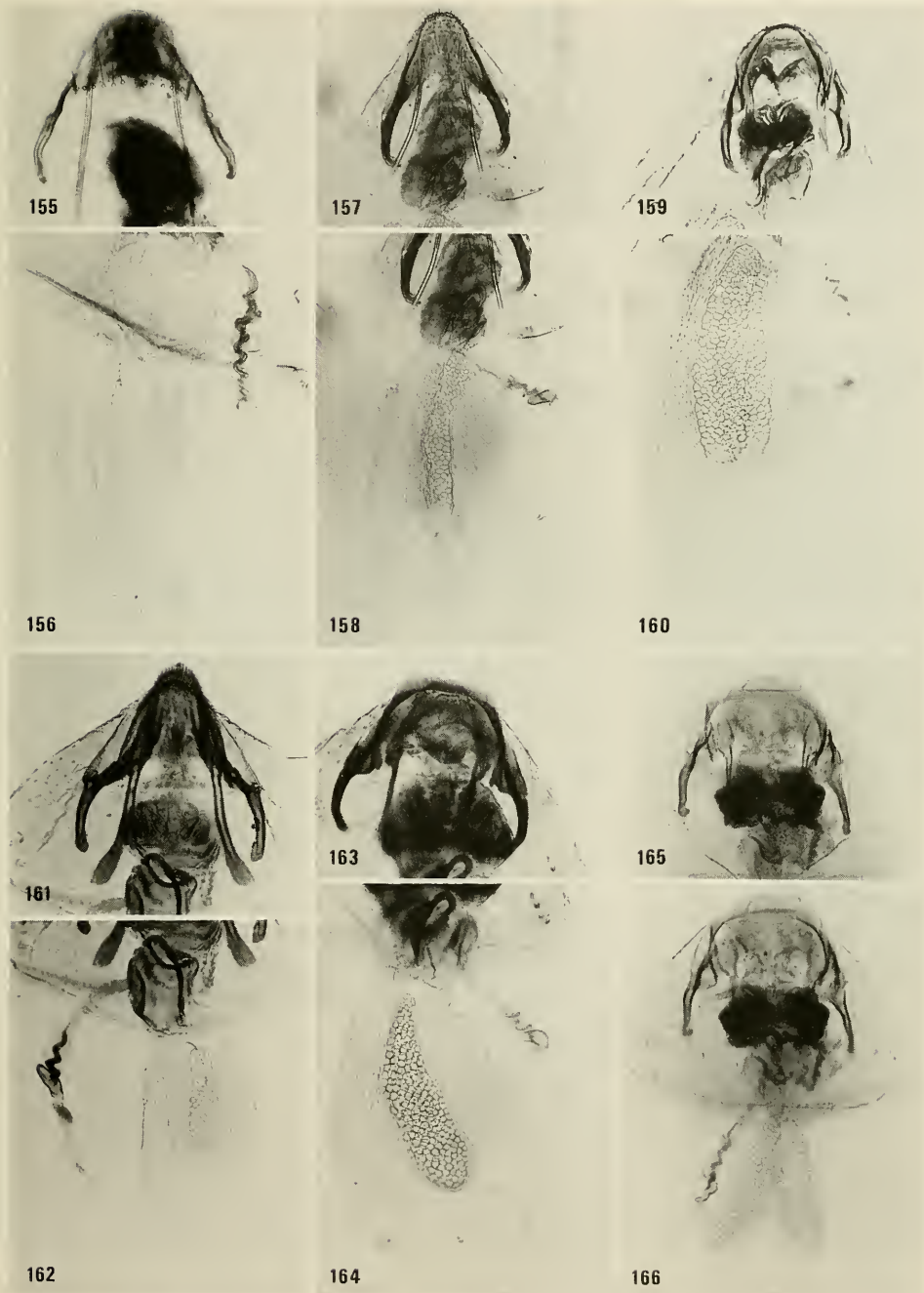

Figs. 155—166. *Ectoedemia* spp., ♀ genitalia. 155, 156, *E. liguricella*, slide VU 1414, Spain, Refugio de Juanar; 157, 158, *E. intimella*, slide VU 1254, England, Earls Colne; 159, 160, *E. hannoverella*, slide MV 12205, East Germany, Bautzen; 161, 162, *E. turbidella*, slide VU 1491, Netherlands, Santpoort; 163, 164, *E. klimeschi*, slide MV 12193, Austria, Hundsheimer Berg; 165, 166, *E. argyropeza*, slide VU 1933, Austria, Gumpoldskirchen.

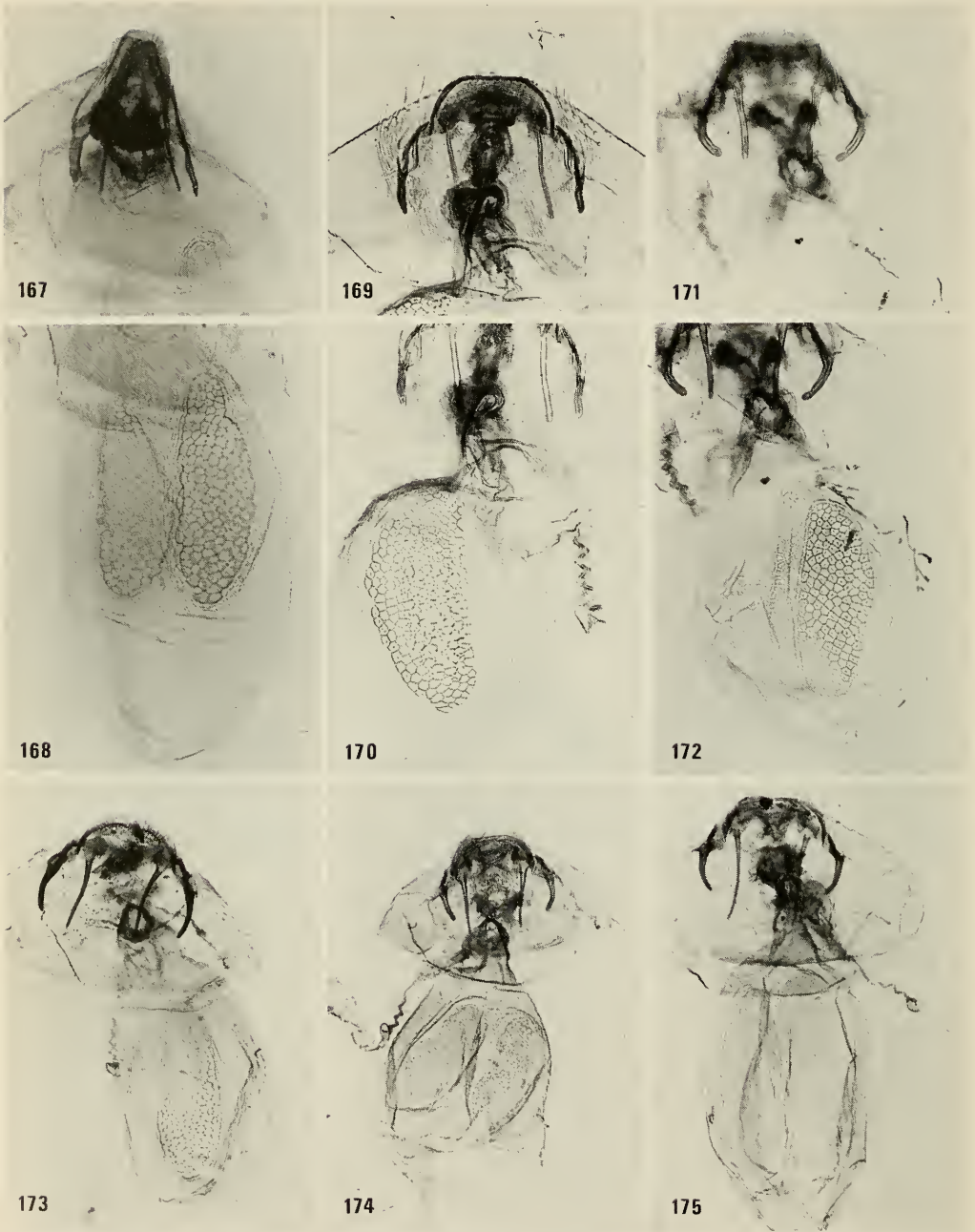

Figs. 167—175. *Ectoedemia* (s.str.) spp., ♀ genitalia. 167, 168, *E. preisseckeri*, slide VU 1955, Hungary, Budapest; 169, 170, *E. suberis*, slide VU 899, France, Golfe Juan; 171, 172, *E. andalusiae*, slide VU 1417, paratype, Spain, Camino de Ojen; 173, *E. caradjai*, slide VU 1447, USSR, Babince, ex *Quercus pubescens*; 174, *E. cf caradjai*, slide VU 1867, Greece, Rhodos, ex *Quercus infectoria*; 175, *E. cf caradjai*, slide VU 1393, Greece, Rhodos, ex *Quercus coccifera*.



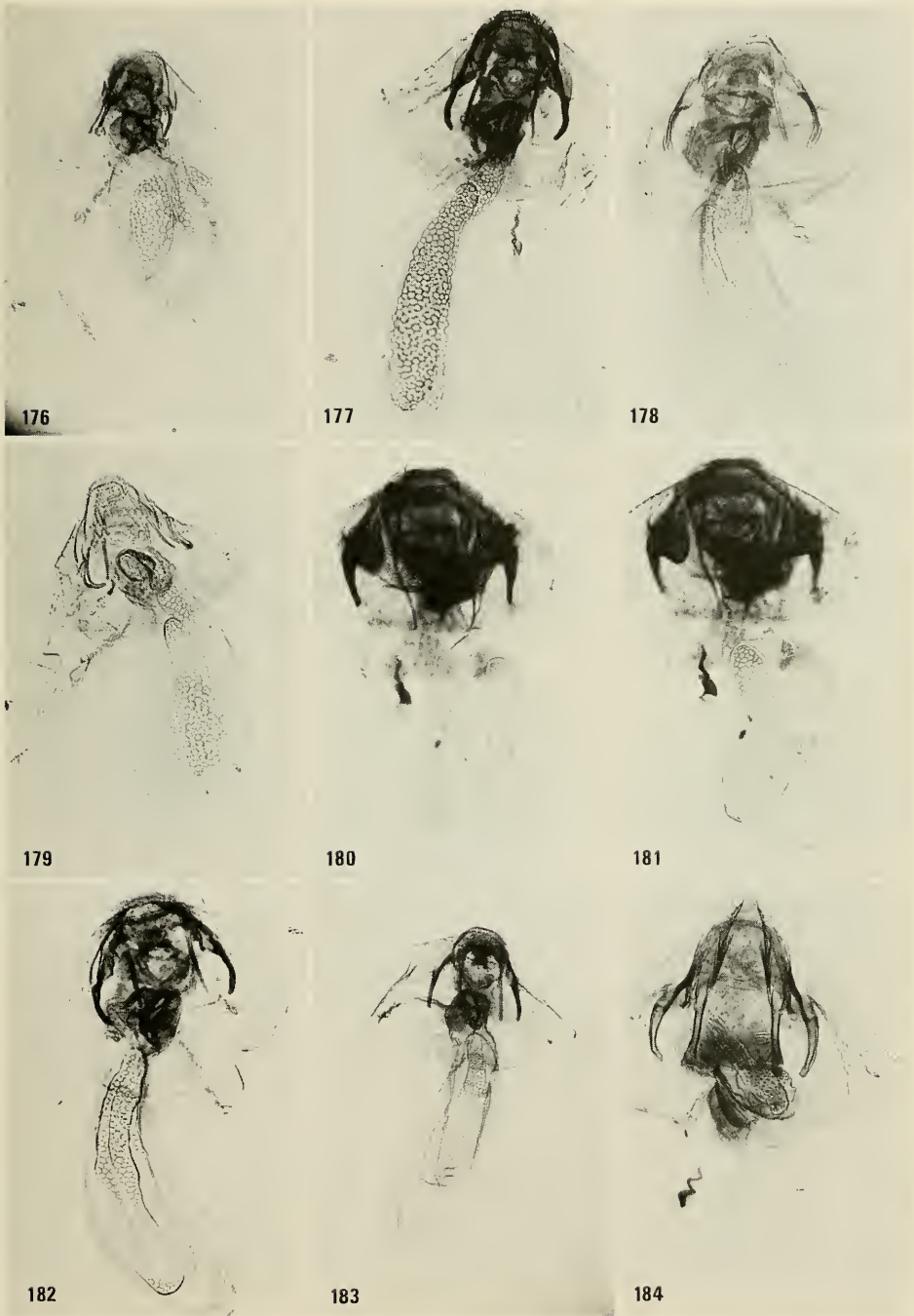

Figs. 176—184. *Ectoedemia* (s.str.) spp., ♀ genitalia. 176, *E. aegilopidella*, slide VU 1390, paratype, Greece, Rhodos; 177, *E. quinquella*, slide VU 898, England, Rainham; 178, *E. algeriensis*, slide VU 1125, holotype; 179, *E. gilvipennella*, slide VU 1380, Hungary, Törökbálint; 180, 181, *E. leucothorax*, slide Klim. 774, paratype, Spain, Marbella; 182, *E. haraldi*, slide VU 901, paralectotype, France, Angoulême; 183, *E. ilicis*, slide VU 943, paralectotype, Portugal, San Fiel; 184, *E. cf. turbidella*, slide VU 1492, Iran, Keredj.

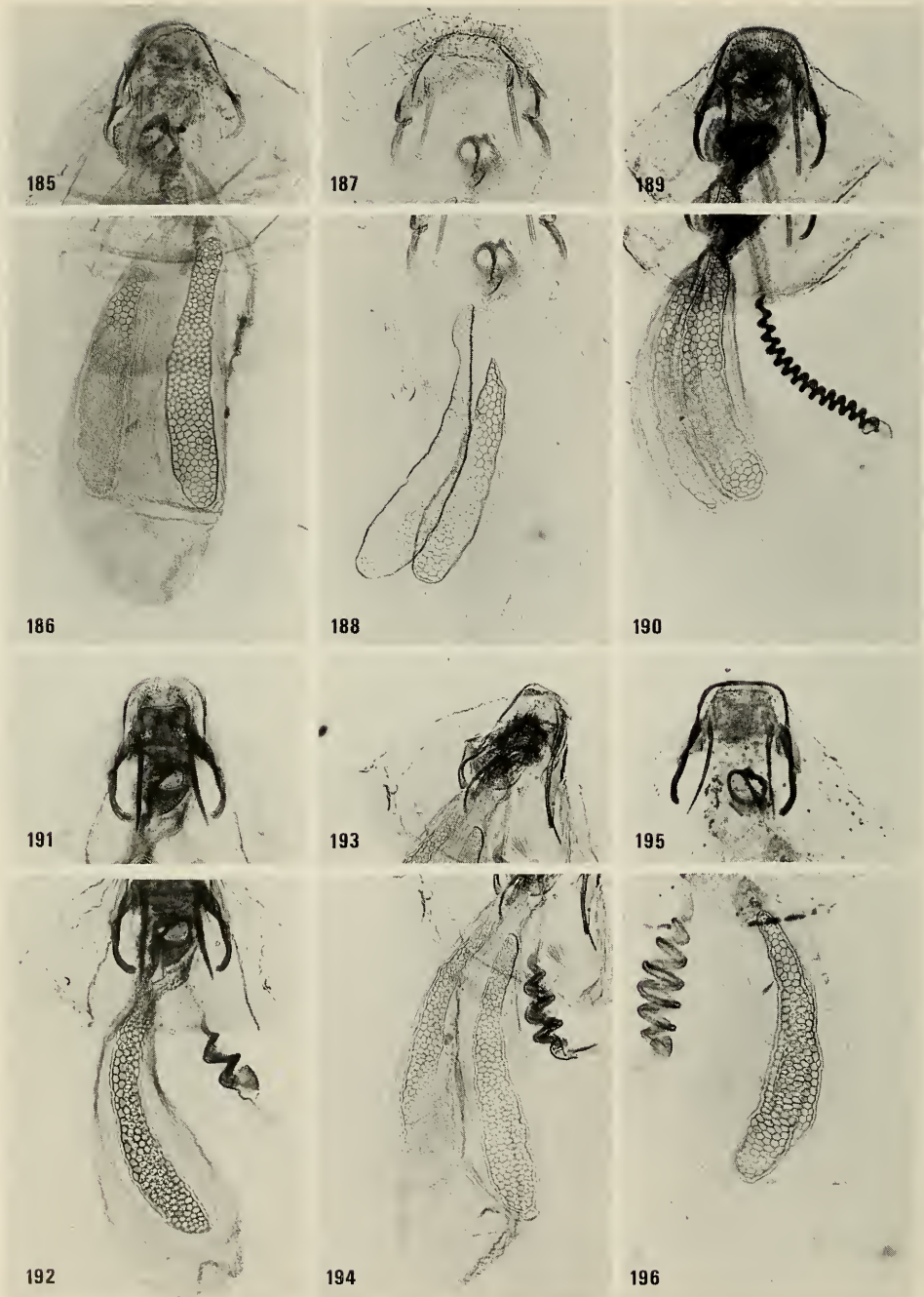

Figs. 185—196. *Ectoedemia* (s.str.) spp., ♀ genitalia. 185, 186, *E. heringella*, slide VU 1398, Italy, Monti Aurunci; 186, 187, *E. alnifoliae*, slide RM 6572, holotype; 189, 190, *E. nigrosparsella*, slide VU 897, Italy, Sardegna; 191, 192, *E. albifasciella*, slide VU 892, Netherlands, Hilversum; 193, 194, *E. cerris*, slide VU 1333, lectotype; 195, 196, *E. pubescivora*, slide VU 1403, Italy, Sardegna, Belvi.



Figs. 197—205. *Ectoedemia* (s.str.) spp., ♀ genitalia. 197, 198, *E. contorta*, slide VU 1388, holotype; 199, 200, *E. subbimaculella*, slide VU 891, Netherlands, Hilversum; 201, 202, *E. terebinthivora*, slide VU 1245, Greece, Dhelfoi; 203, *E. beringi*, slide VU 894, paralectotype *N. zimmermanni*, Czechoslovakia, Libochowan; 204, *E. liechtensteini*, slide VU 1876, Hungary, Törökbálint; 205, *E. phyllotomella*, slide VU 1392, paralectotype, Italy, Ferrania.





Figs. 206—214. *Ectoedemia* (s.str.) spp., ♀ genitalia. 206, *E. spec.* (specimen 1375), slide VU 1375, Iran, W. Shiraz; 207, *E. erythrogenerella*, slide VU 972, France, Vannes; 208, *E. spiracae*, VU 1868, paratype, Czechoslovakia, Čingov; 209, *E. agrimoniae*, slide VU 970, Greece, Kátsika; 210, *E. hexapetalae*, slide VU 1741, Hungary, Budaörs; 211, *E. angulifasciella*, slide MV 12178, no locality, ex *Rosa*; 212, *E. angulifasciella*, slide VU 1345, paralectotype *N. utensis*, Switzerland, Zürich, ex *Sanguisorba*; 213, *E. atricollis*, slide MV 12177, Austria, Linz; 214, *E. atricollis*, slide VU 1186, Hungary, Budapest, ex *Staphylea*.

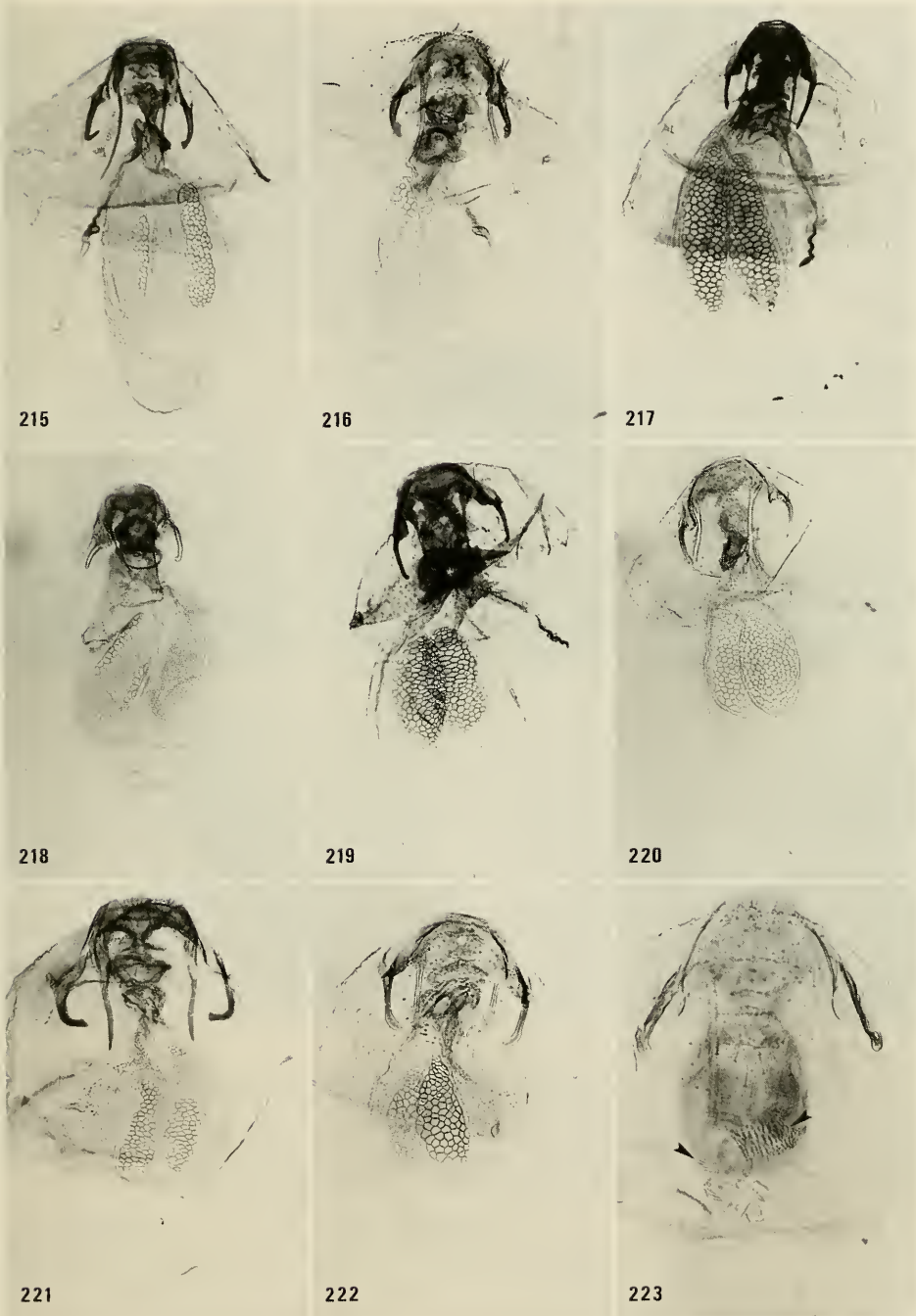

Figs. 215—222. *Ectoedemia* (s.str.) spp., ♀ genitalia. 215, *E. arcuatella*, slide MV 12183, Austria, Wien; 216, *E. rubivora*, slide VU 964, Netherlands, Winterswijk; 217, *E. spinosella*, slide VU 947, lectotype; 218, *E. spinosella*, slide VU 1171, Greece, Arákhova, ex *Prunus dulcis*; 219, *E. mahalebella*, slide VU 976, Greece, Mt. Timfristos; 220, *E. mahalebella*, slide VU 1751, Hungary, Budaörs; 221, *E. occultella*, slide VU 1182, Austria; 222, *E. minima*, slide VU 1220, France, Pralognan; 223, *E. (Zimmermannia) amani*, detail of vestibulum with two groups of spines (arrows), slide VU 918, Sweden, Kullaberg.



Figs. 224—230. *Ectoedemia* (s.str.) spp., details of ♀ genitalia. 224, 225, 227, 228, Vestibulum; 226, 229, 230, Part of bursa with signa. 224, *E. preisseckeri*, with dense concentration of pectinations (arrow), slide VU 1955; 225, *E. terebinthivora*, spiculate pouch with single, long pointed spines, slide VU 1245; 226, *E. agrimoniae*, "spiny" signa, slide VU 970; 227, *E. hannoverella*, spiculate pouch with "single" spines, slide VU 1208; 228, *E. contorta*, spiculate pouch with single and grouped spines, slide VU 1388, holotype; 229, *E. hannoverella*, bursa with pectinations, slide VU 1208; 230, *E. contorta*, bursa smooth, slide VU 1388, holotype.



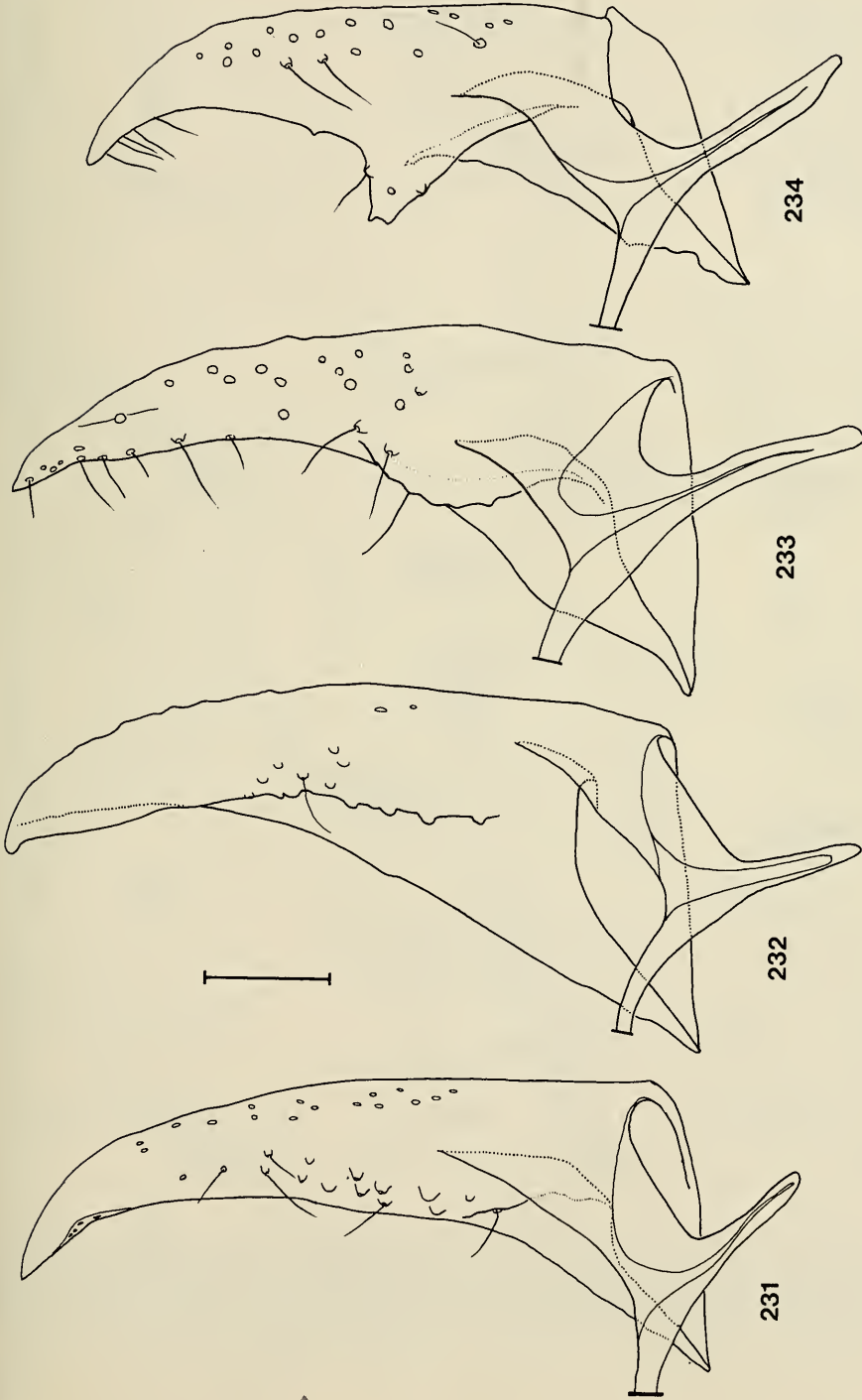

Figs. 231—234. *Ectoedemia* (*Zimmermannia*) spp., ♂, valva, dorsal (inner) aspect. 231, *E. atrifrontella*, slide VU 938, France, "Antarv.", 232, *E. liebwerdella*, slide VU 1457, East Germany, Tharandt; 233, *E. longicaudella*, slide MV 12138, Austria, Gumpoldskirchen; 234, *E. hispanica*, slide VU 1830, paratype, Spain, Rubielos de Mora. Scale: 0.05 mm.

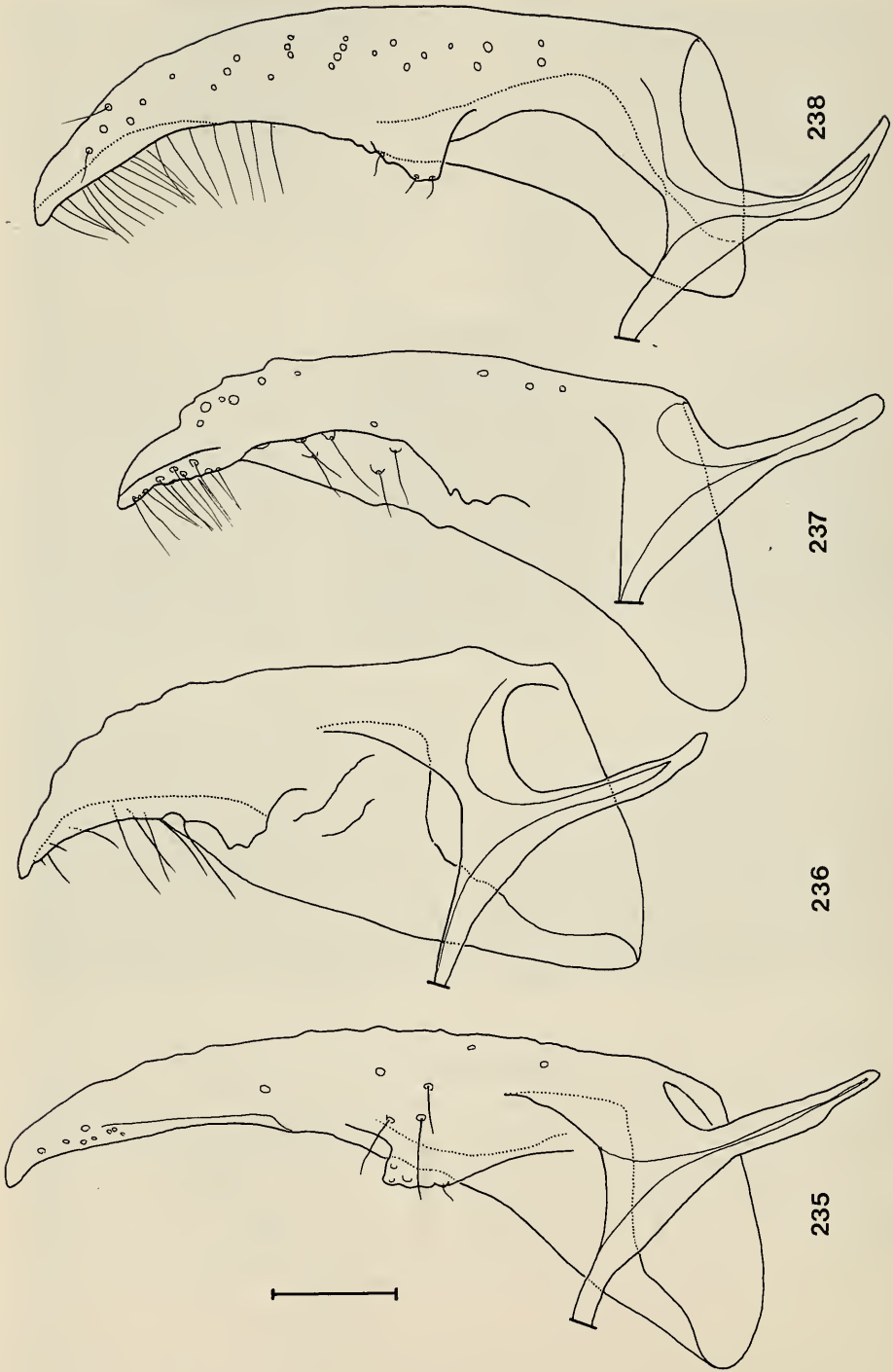

Figs. 235—238. *Ectoedemia* (*Zimmermannia*) spp., ♂, valva, dorsal (inner) aspect. 235, *E. monemvasiae*, slide VU 1372, paratype, Greece, Monemvasia; 236, *E. amani*, slide VU 1865, Austria, Klosterneuburg; 237, *E. nurlistanica*, slide MV 5402, holotype; 238, *E. liguricella*, slide VU 1828, Spain, Sierra Alfacar. Scale: 0.05 mm.

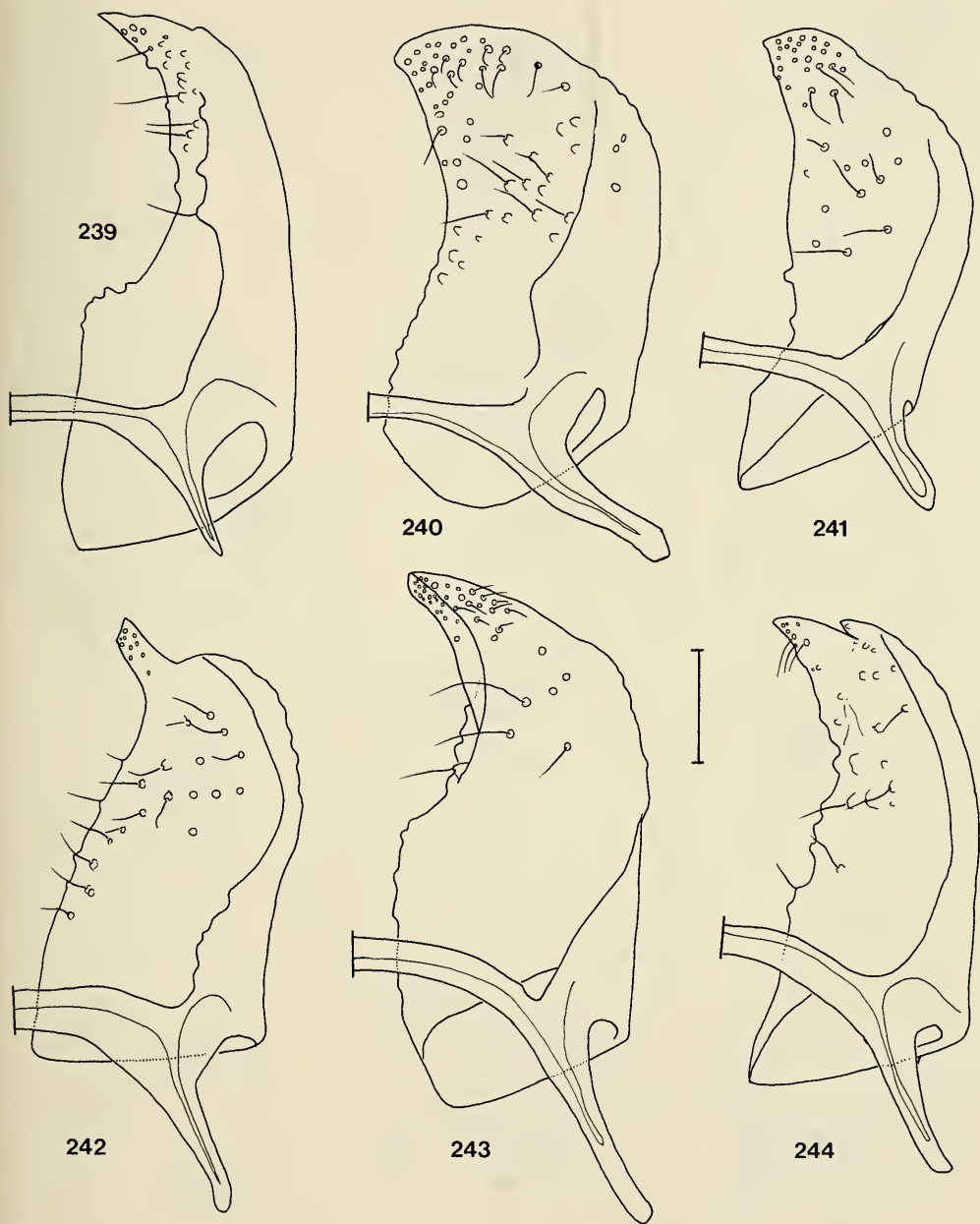

Figs. 239—244. *Ectoedemia* (s.str.) spp., *populella* and *preisseckeri* groups, ♂ valva, dorsal (inner) aspect. 239, *E. intimella*, slide VU 1253, England, Earls Colne; 240, *E. populella*, slide VU 1252, syntype, USA; 241, *E. hannoverella*, slide MV 12202, West Germany, Baiern; 242, *E. turbidella*, slide MV 12206, Austria, Linz; 243, *E. klimeschi*, slide VU 1230, Austria, Linz; 244, *E. preisseckeri*, slide MV 12218, Austria, Wien. Scale: 0.05 mm.



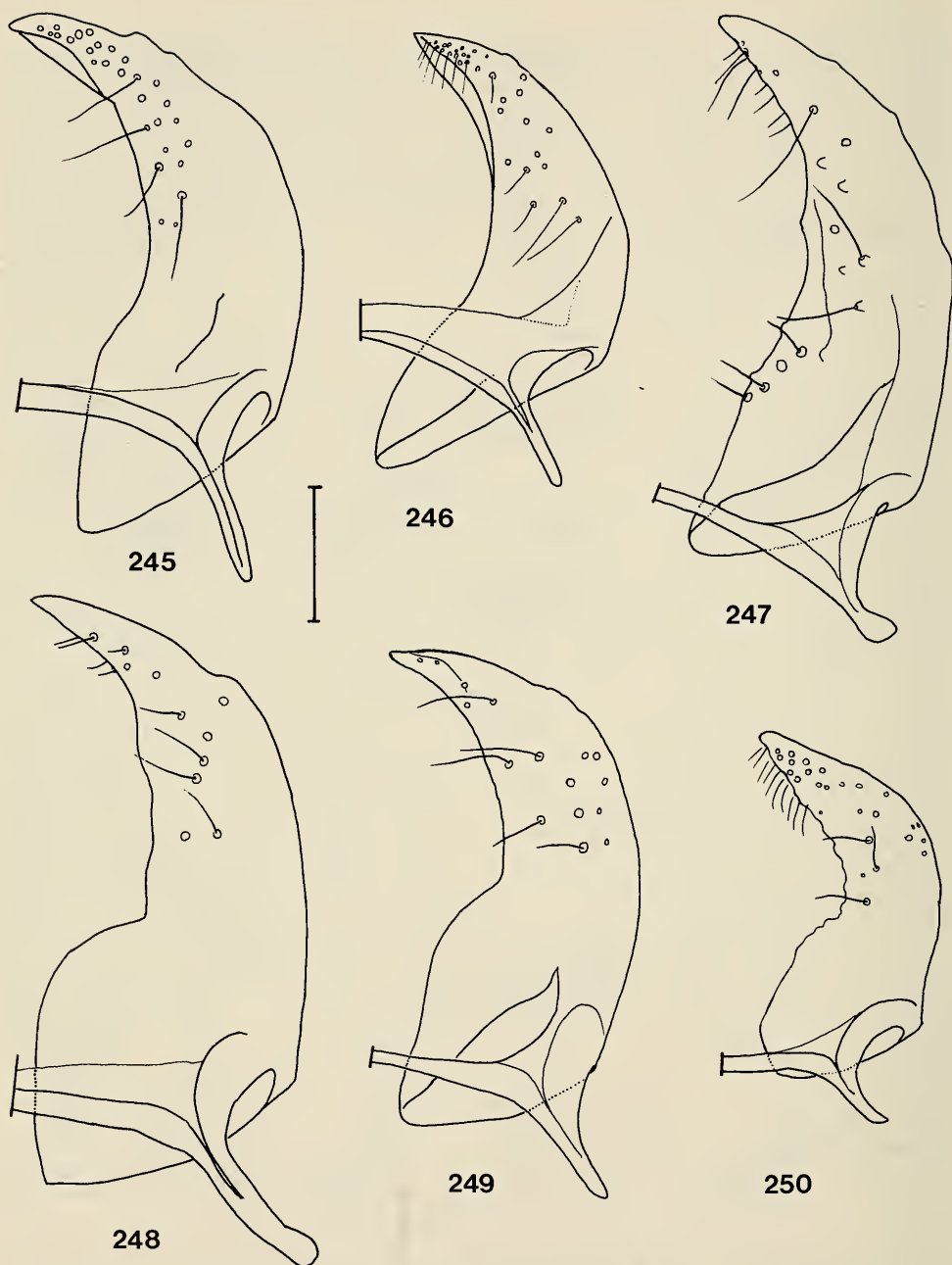

Figs. 245—250. *Ectoedemia* (s.str.) spp., *suberis* group, ♂, valva, dorsal (inner) aspect. 245, *E. caradjai*, slide MV 12153, Austria, Gumpoldskirchen; 246, *E. cf. caradjai*, slide Klim. 4200, Greece, Rhodos, from *Quercus infectoria*; 247, *E. spec.* (specimen 1843), slide VU 1843, Spain, Rubielos de Mora; 248, *E. suberis*, slide VU 1112, France, "Nesp."; 249, *E. andalusiae*, slide VU 1416, paratype, Spain, Camino de Ojen; 250, *E. aegilopidella*, slide Klim. 1299, paratype, Greece, Rhodos. Scale: 0.05 mm.

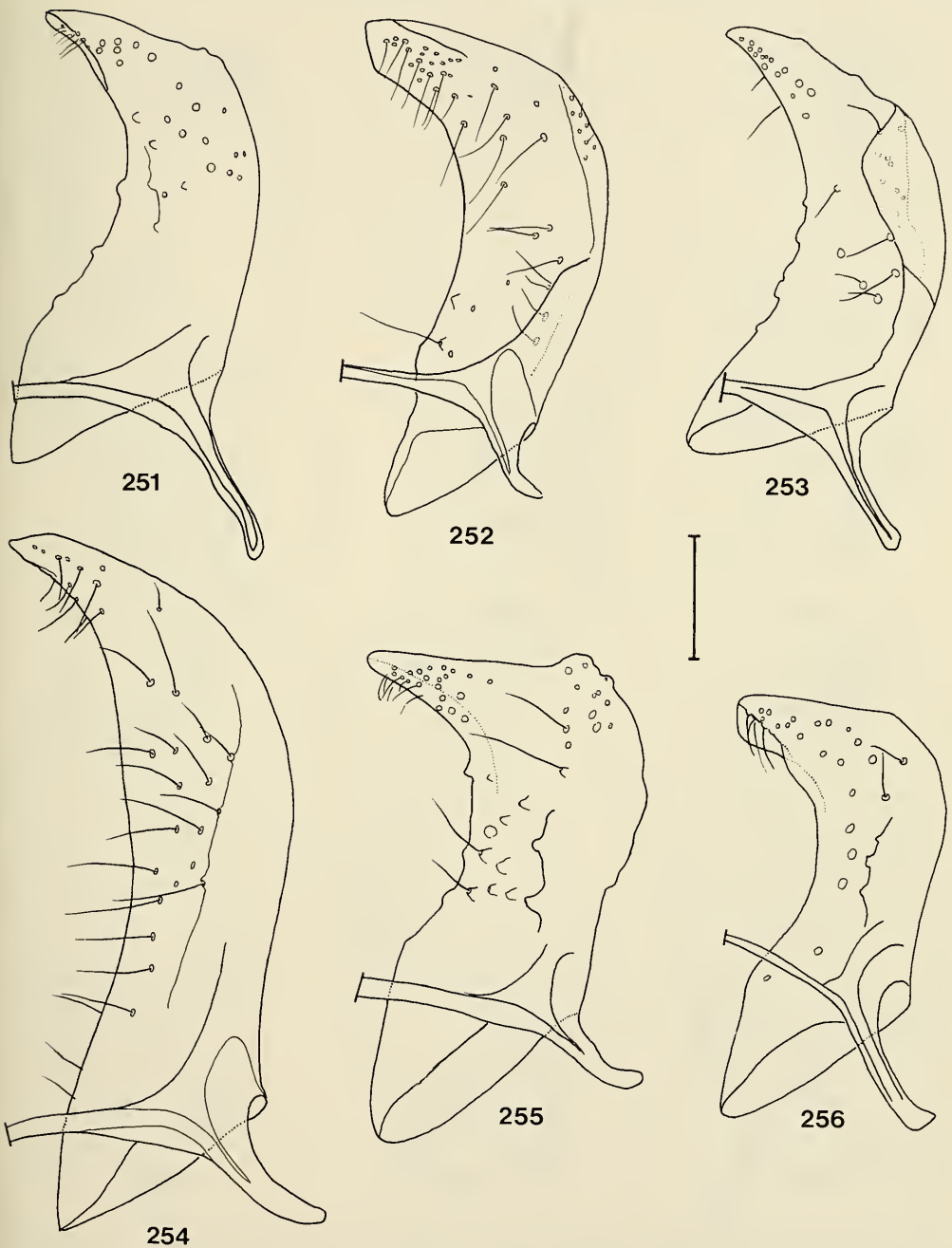

Figs. 251—256. *Ectoedemia* (s.str.) spp., *subbimaculella*-group, ♂, valva, dorsal (inner) aspect. 251, *E. quin-quella*, slide VU 1111, England, Rainham; 252, *E. cf. algeriensis*, slide VU 1864, Morocco, Azrou; 253, *E. gilvi-pennella*, slide VU 1381, Hungary, Törökbálint; 254, *E. leucothorax*, slide VU 1885, paratype, Spain, Camino de Ojen; 255, *E. baraldi*, slide VU 942, Portugal, [San Fiel]; 256, *E. ilicis*, slide VU 1358, lectotype. Scale: 0.05 mm.

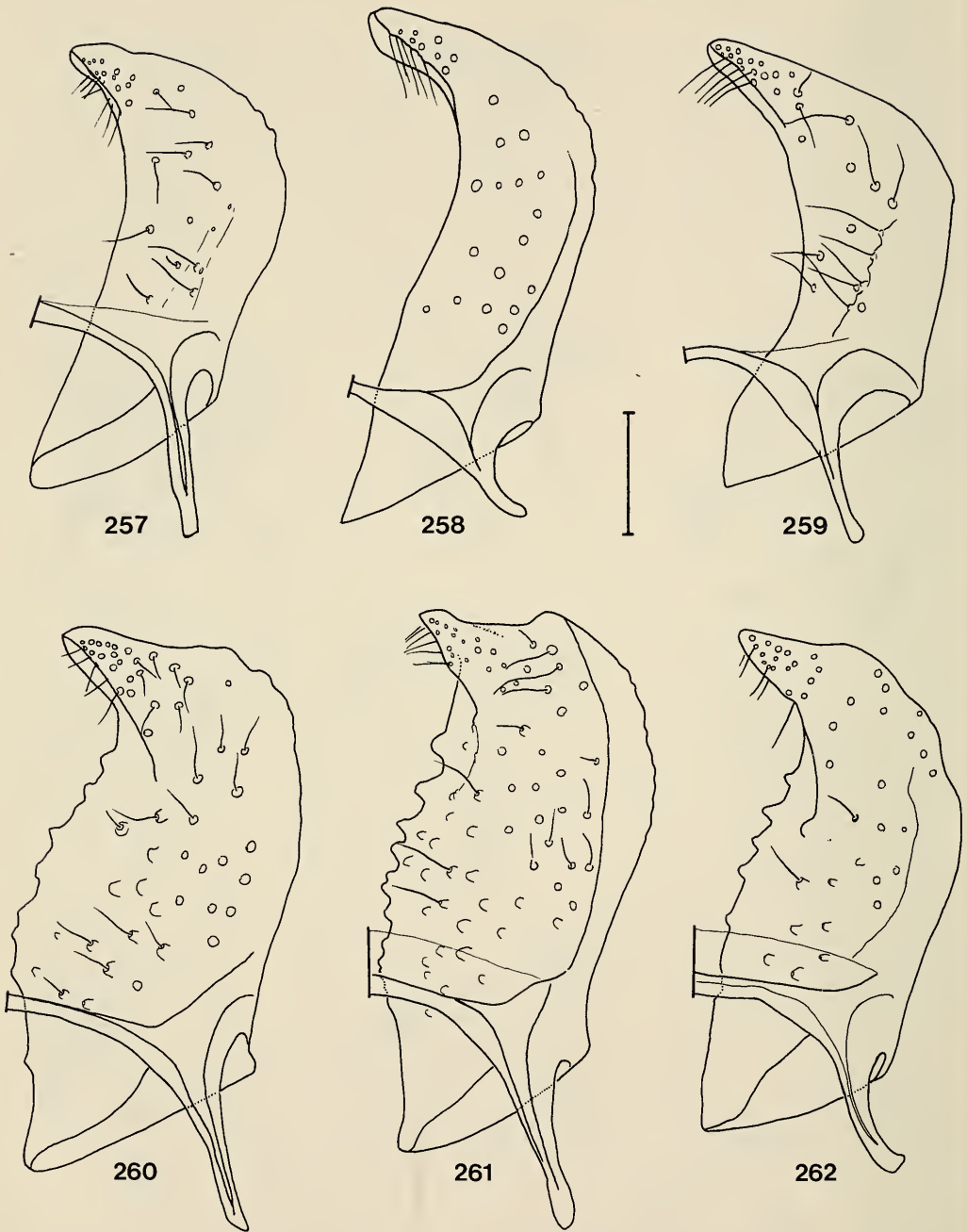

Figs. 257—262. *Ectoedemia* (s.str.) spp., *subbimaculella* group, ♂, valva, dorsal (inner) aspect. 257, *E. ilicis*, slide VU 1420, Spain, Marbella; 258, *E. heringella*, slide VU 1395, Italy, Monti Aurunci; 259, *E. heringella*, slide RM 6666, Cyprus, Arakapos; 260, *E. nigrosparsella*, slide VU 1378, Hungary, Törökbálint; 261, *E. albifasciella*, slide VU 637, Netherlands, Winterswijk; 262, *E. cerris*, slide VU 1729, Hungary, Szár. Scale: 0.05 mm.



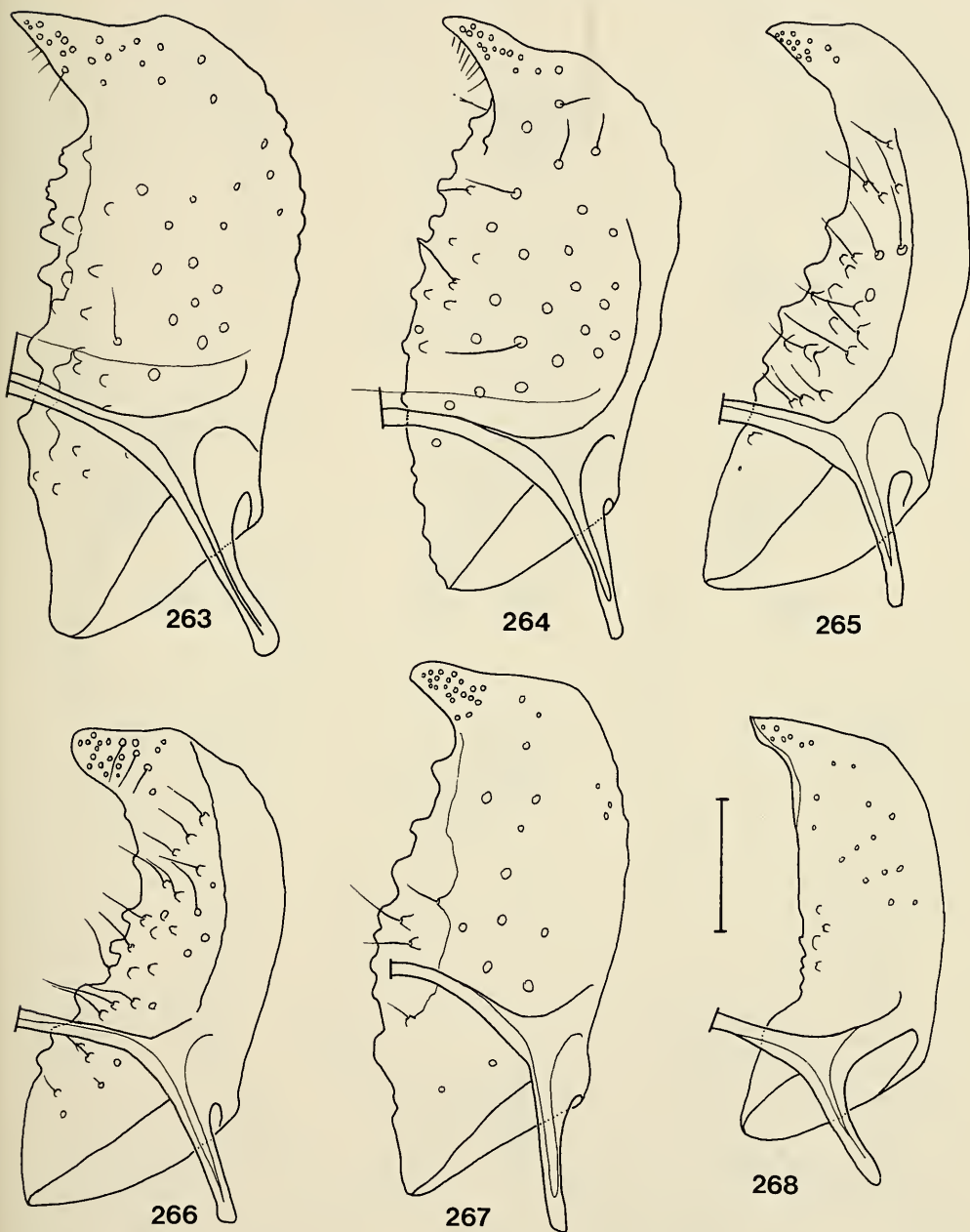

Figs. 263—268. *Ectoedemia* (s.str.) spp., *subbimaculella* and *terebinthivora* group, ♂, valva, dorsal (inner) aspect. 263, *E. pubescivora*, slide VU 1342, paralectotype, Switzerland, Somazzo; 264, *E. cf. contorta*, slide VU 1387, Hungary, Nagykovácsi; 265, *E. subbimaculella*, slide VU 1105, France, Alouette Pessac; 266, *E. beringi*, slide MV 12142, Austria, Klosterneuburg; 267, *E. phyllotomella*, slide Klim. 269, paralectotype, Italy, Ferrania; 268, *E. terebinthivora*, slide VU 1250, Greece, Dhelfoi. Scale: 0.05 mm.

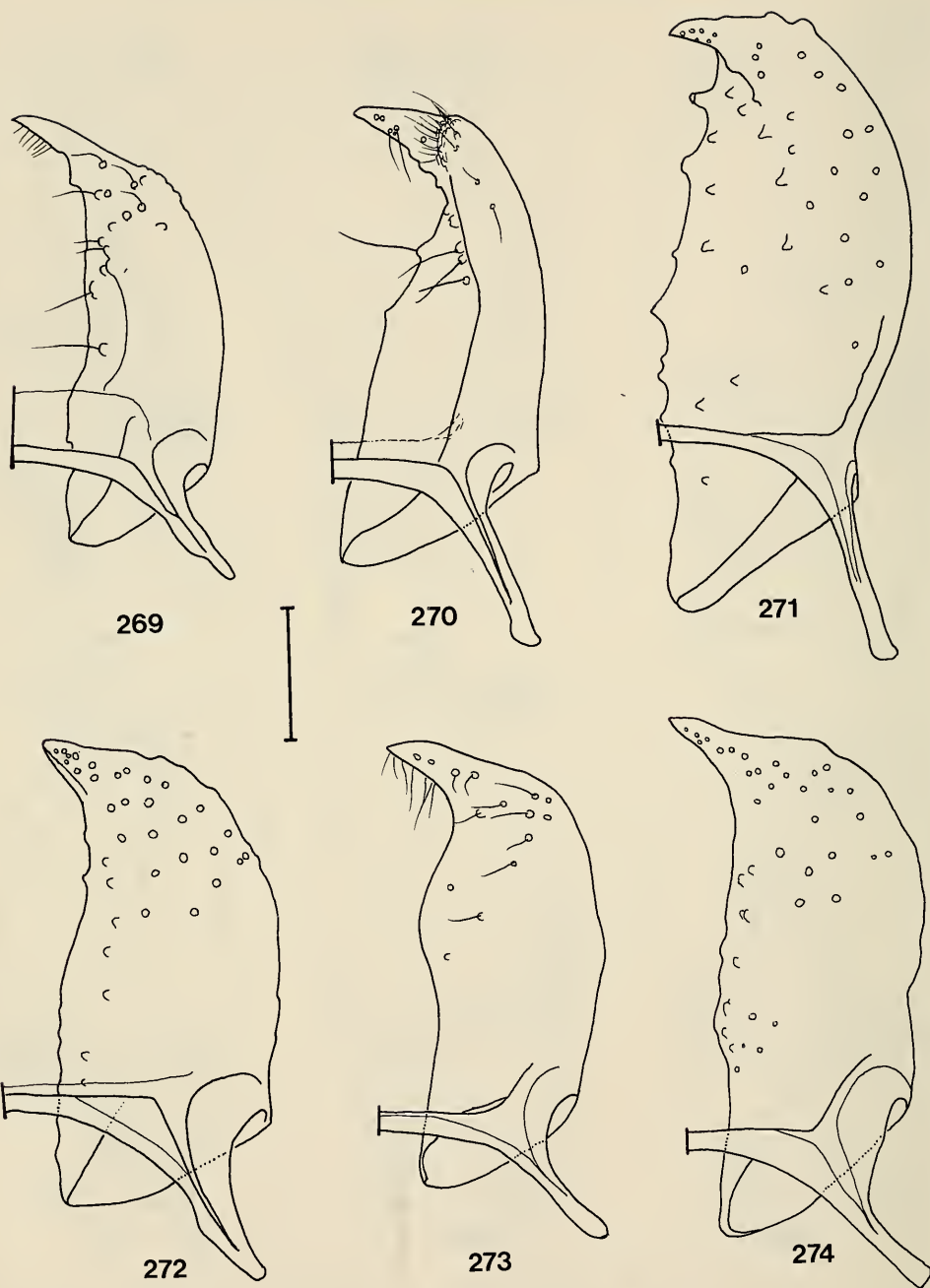

Figs. 269—274. *Ectoedemia* (s.str.) spp., *angulifasciella* group, ♂, valva, dorsal (inner) aspect. 269, *E. erythro-*  
*genella*, slide VU 1170, paralectotype, France, Vannes; 270, *E. agrimoniae*, slide VU 642, Greece, Evvoia; 271,  
*E. spiraeae*, slide VU 873, Hungary, Sástó; 272, *E. hexapetalae*, slide VU 1739, Hungary, Budaörs; 273,  
*E. angulifasciella*, slide MV 12180, Austria, Hundsheimer Berg; 274, *E. atricollis*, slide VU 608, Netherlands,  
 Winterswijk. Scale: 0.05 mm.

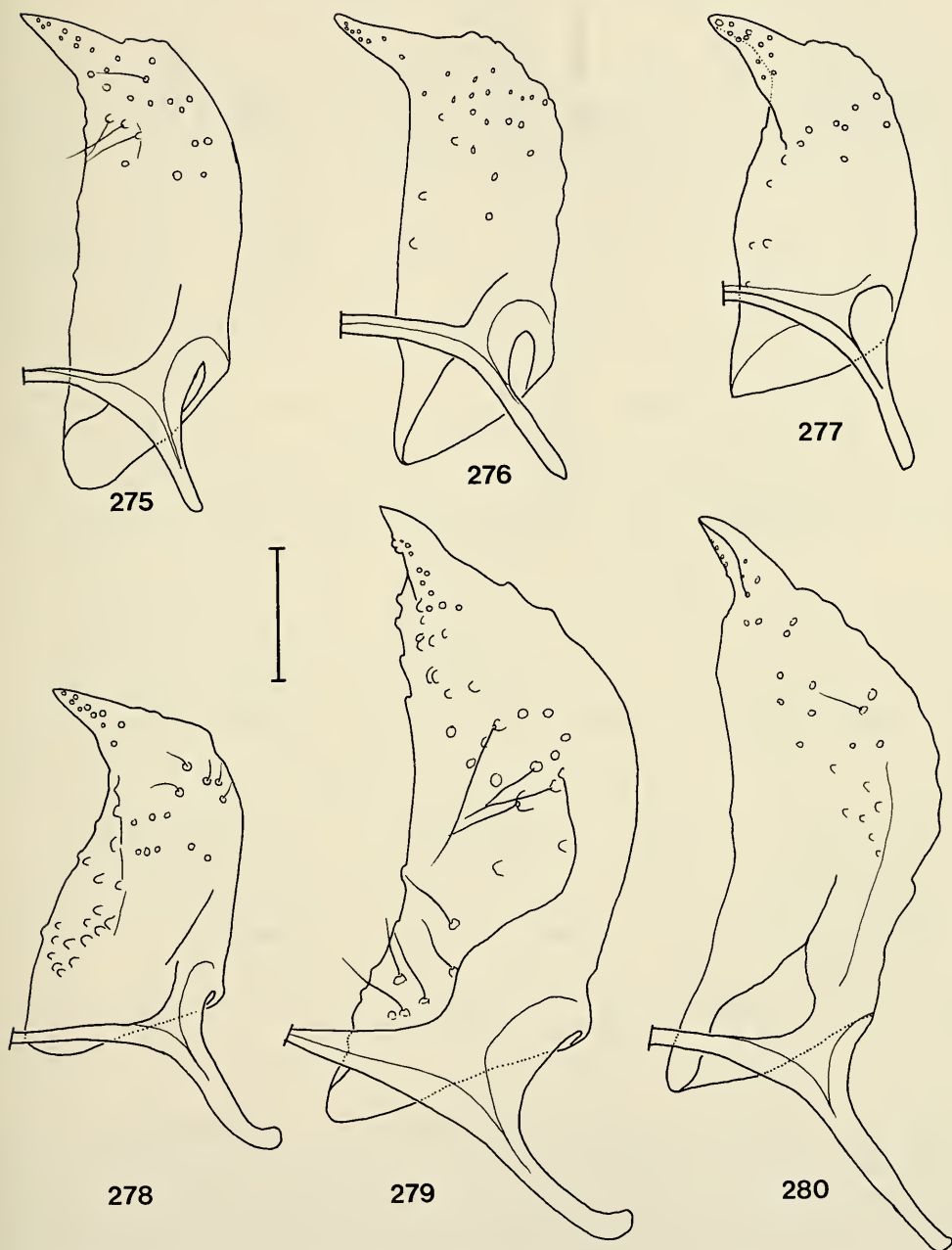

Figs. 275—280. *Ectoedemia* (s.str.) spp., *angulifasciella* and *occultella* group, ♂, valva, dorsal (inner) aspect. 275, *E. arcuatella*, slide MV 12184, East Germany, Friedland; 276, *E. rubivora*, slide VU 1103, Denmark, Faaborg; 277, *E. spinosella*, slide VU 1137, Netherlands, Gulpen; 278, *E. mahalebella*, slide VU 881, Greece, Mt. Timfristos; 279, *E. occultella*, slide VU 1226, Netherlands, Rockanje; 280, *E. minimella*, slide VU 1173, Norway, Rennebu. Scale: 0.05 mm.



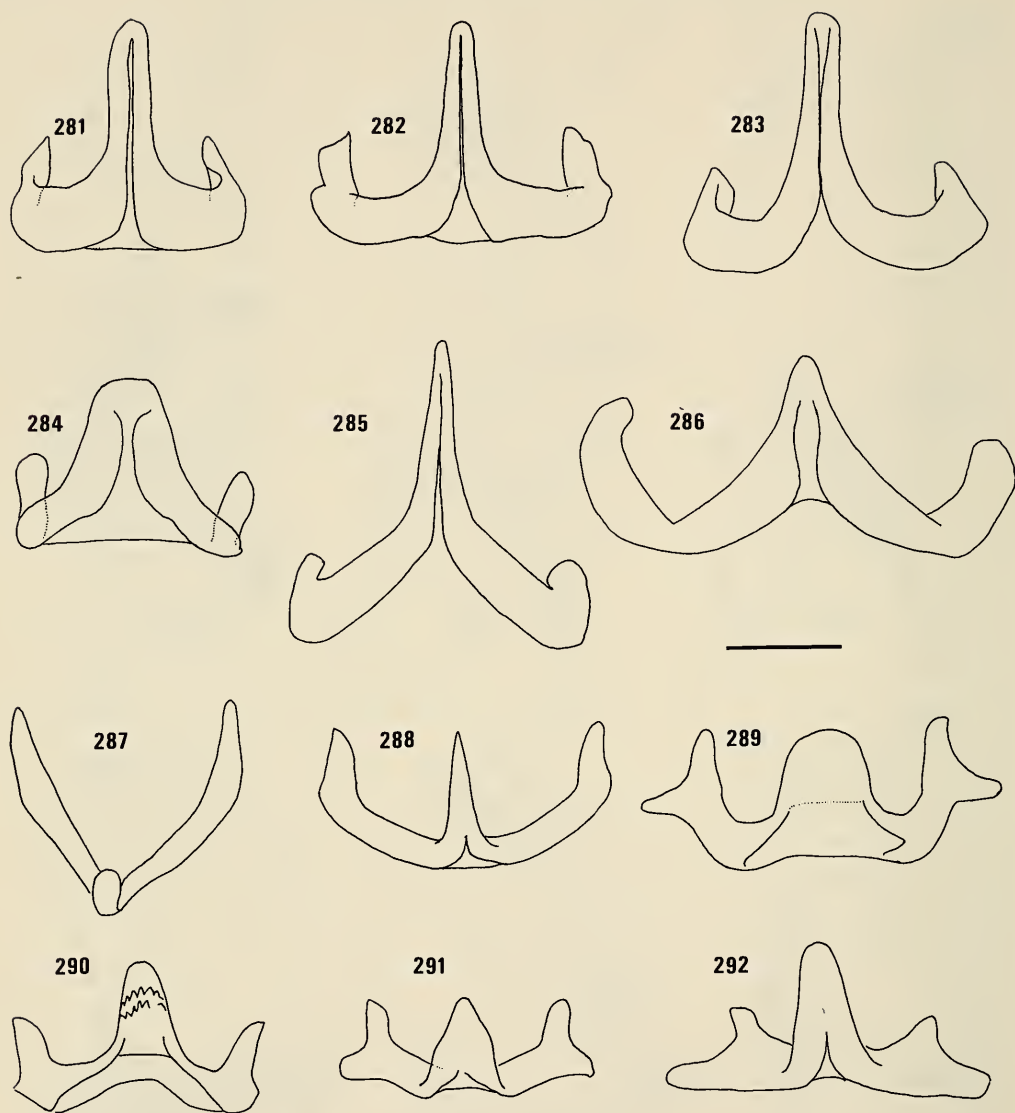

Figs. 281—292. *Ectoedemia* spp., ♂ genitalia, gnathos, ventral aspect (287 ventro-caudal aspect). 281, *E. atrifrontella*, slide VU 937, France, Digne; 282, *E. liebwerdella*, slide VU 1832, France, St. Barnabé; 283, *E. longicaudella*, slide VU 983, France, Digne; 284, *E. hispanica*, slide VU 1931, holotype; 285, *E. monemvasiae*, slide VU 1372, paratype, Greece, Monemvasia; 286, *E. amani*, slide MV 5752, Austria, Hundsheimer Berg; 287, *E. nuristanica*, slide MV 5402, holotype; 288, *E. liguricella*, slide VU 1828, Spain, Sierra Alfacar; 289, *E. intimella*, slide VU 1253, England, Earls Colne; 290, *E. hannoverella*, slide VU 292, West Germany, Regensburg; 291, *E. turbidella*, slide MV 12206, Austria, Linz; 292, *E. klimeschi*, slide VU 1230, Austria, Linz. Scale: 0.05 mm.

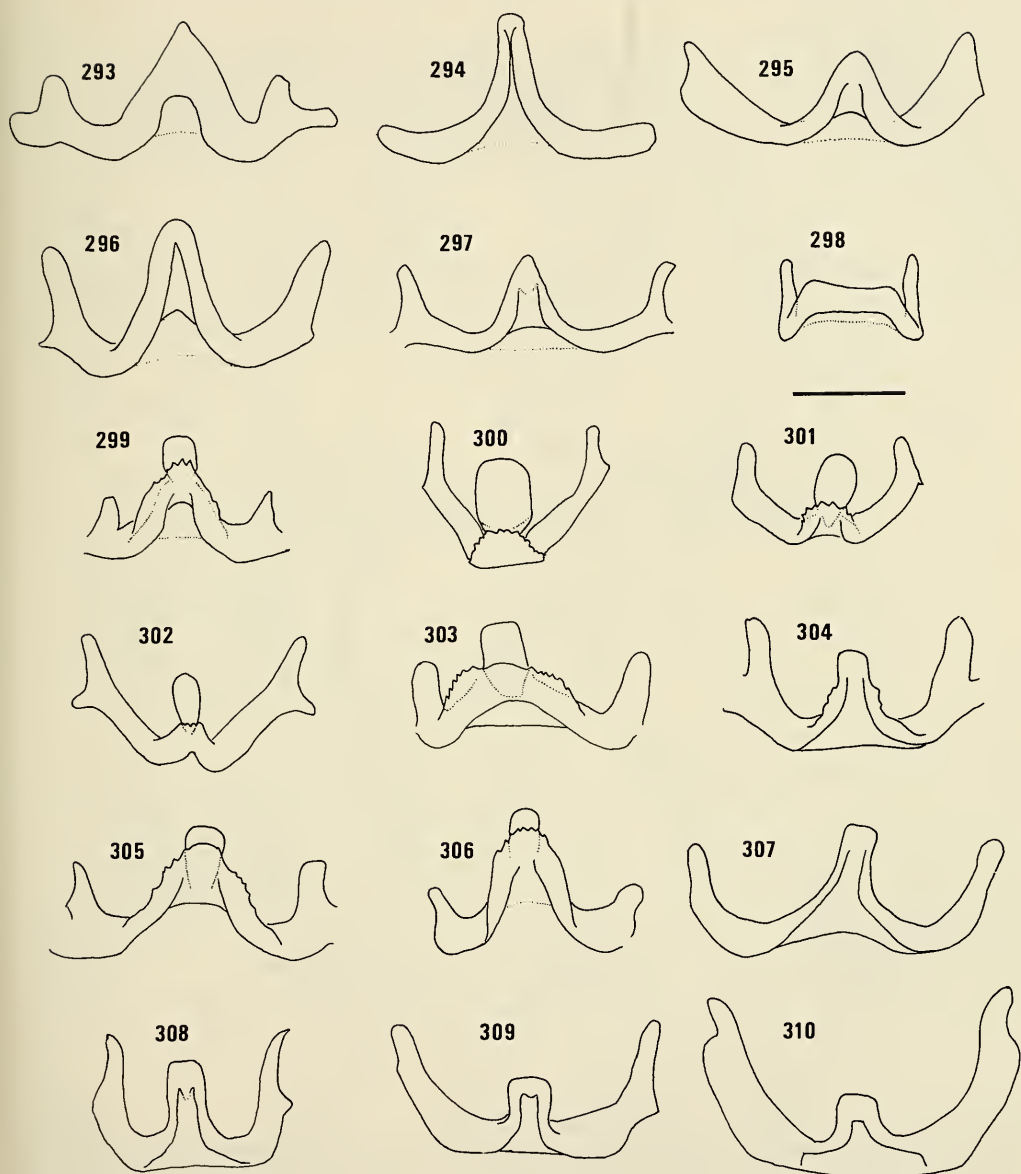

Figs. 293—310. *Ectoedemia* spp., ♂ genitalia, gnathos, ventral aspect. 293, *E. preisseckeri*, slide MV 12218, Austria, Wien; 294, *E. caradjai*, slide RJ 946, Italy, Monti Aurunci (slightly squashed); 295, *E. spec.* (specimen 1843), slide VU 1843, Spain, Rubielos de Mora; 296, *E. suberis*, slide VU 1112, "Nesp."; 297, *E. andalusiae*, slide VU 1416, paratype, Spain, Camino de Ojen; 298, *E. aegilopidella*, slide Klim. 1298, paratype, Greece, Rhodos; 299, *E. quinquella*, slide VU 1110, France, L'Étang-la-Ville; 300, *E. cf algeriensis*, slide VU 1864, Morocco, Azrou; 301, *E. gilvipennella*, slide Klim. 272, lectotype; 302, *E. leucothorax*, slide VU 1885, paratype, Spain, Camino de Ojen; 303, *E. haraldi*, slide VU 868, paralectotype, France, Angoulême; 304, *E. ilicis*, slide VU 1420, Spain, Marbella; 305, *E. beringella*, slide VU 1395, Italy, Monti Aurunci; 306, *E. beringella*, slide RM 6666, Cyprus, Arakapos; 307, *E. nigrosparsella*, slide VU 1736, Hungary, Törökbálint; 308, *E. albifasciella*, slide VU 240, Netherlands, Hollandse Rading; 309, *E. albifasciella*, slide VU 1199, Netherlands, Overveen (position of gnathos slightly different from 308); *E. cerris*, slide VU 1729, Hungary, Szár. Scale: 0.05 mm.

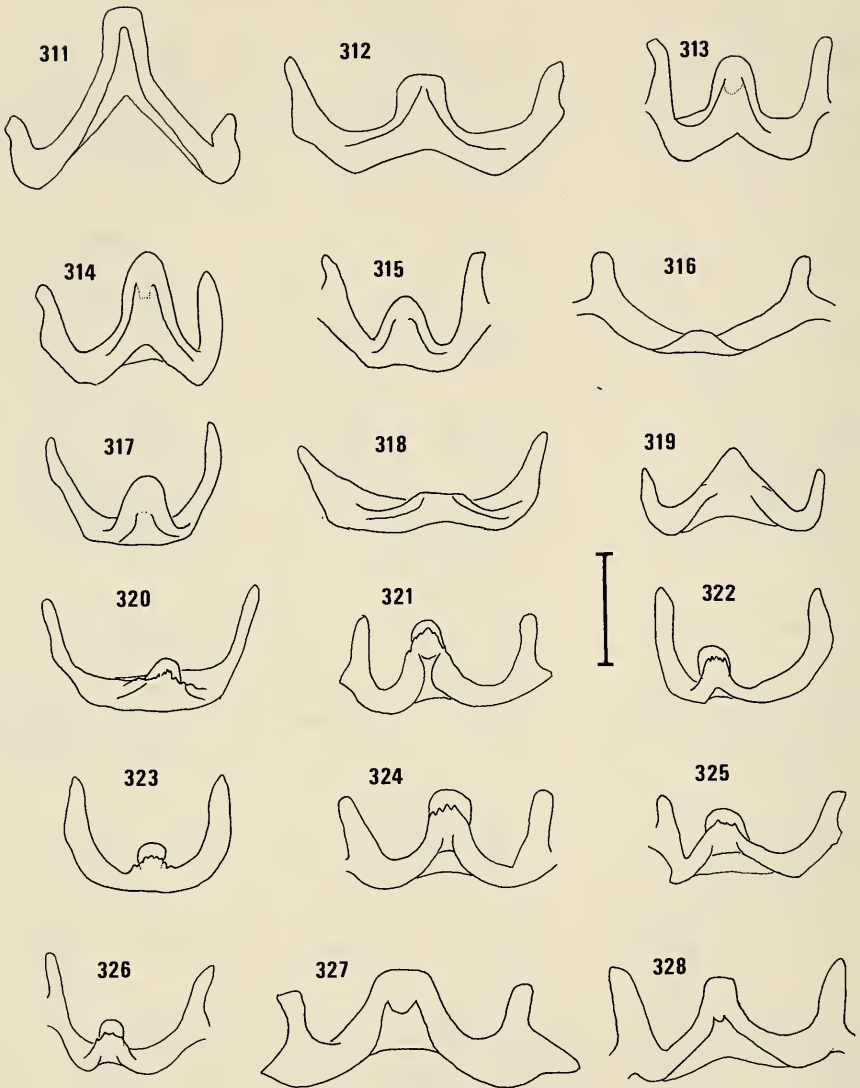

Figs. 311—328. *Ectoedemia* spp., ♂ genitalia, gnathos, ventral aspect. 311, *E. pubescivora*, slide VU 1342, paralectotype, Switzerland, Somazzo; 312, *E. cf. contorta*, slide VU 909, Austria, Hundsheimer Berg; 313, *E. subbi-maculella*, slide VU 1105, France, Alouette Pessac; 314, *E. heringi*, slide VU 1731, Hungary, Pécs Mecsek; 315, *E. heringi*, slide VU 867, paralectotype *N. zimmermanni*, Czechoslovakia, Libochowan; 316, *E. terebinthivora* slide VU 1250, Greece, Dhelfoi; 317, *E. erythrogonella*, slide VU 946, lectotype; 318, *E. spiraeae*, slide VU 1187, Hungary, Sástó; 319, *E. agrimoniae*, slide VU 642, Greece, Evvoia; 320, *E. hexapetalae*, slide VU 1740, Hungary, Budapest; 321, *E. angulifasciella*, slide VU 1870, Netherlands, Ootmarsum; 322, *E. atricollis*, slide VU 1152, France, Clamart; 323, *E. arcuatella*, slide MV 12184, East Germany, Friedland; 324, *E. rubivora*, slide VU 1001/1002, Netherlands, Winterswijk; 325, *E. spinosella*, slide VU 1139, paralectotype, France, Vannes; 326, *E. mahalebella*, slide VU 997, Greece, Mt. Timfristos; 327, *E. occultella*, slide VU 1495, Netherlands, Kerkrade; 328, *E. minimella*, slide VU 825, Norway, Rennebu. Scale: 0.05 mm.



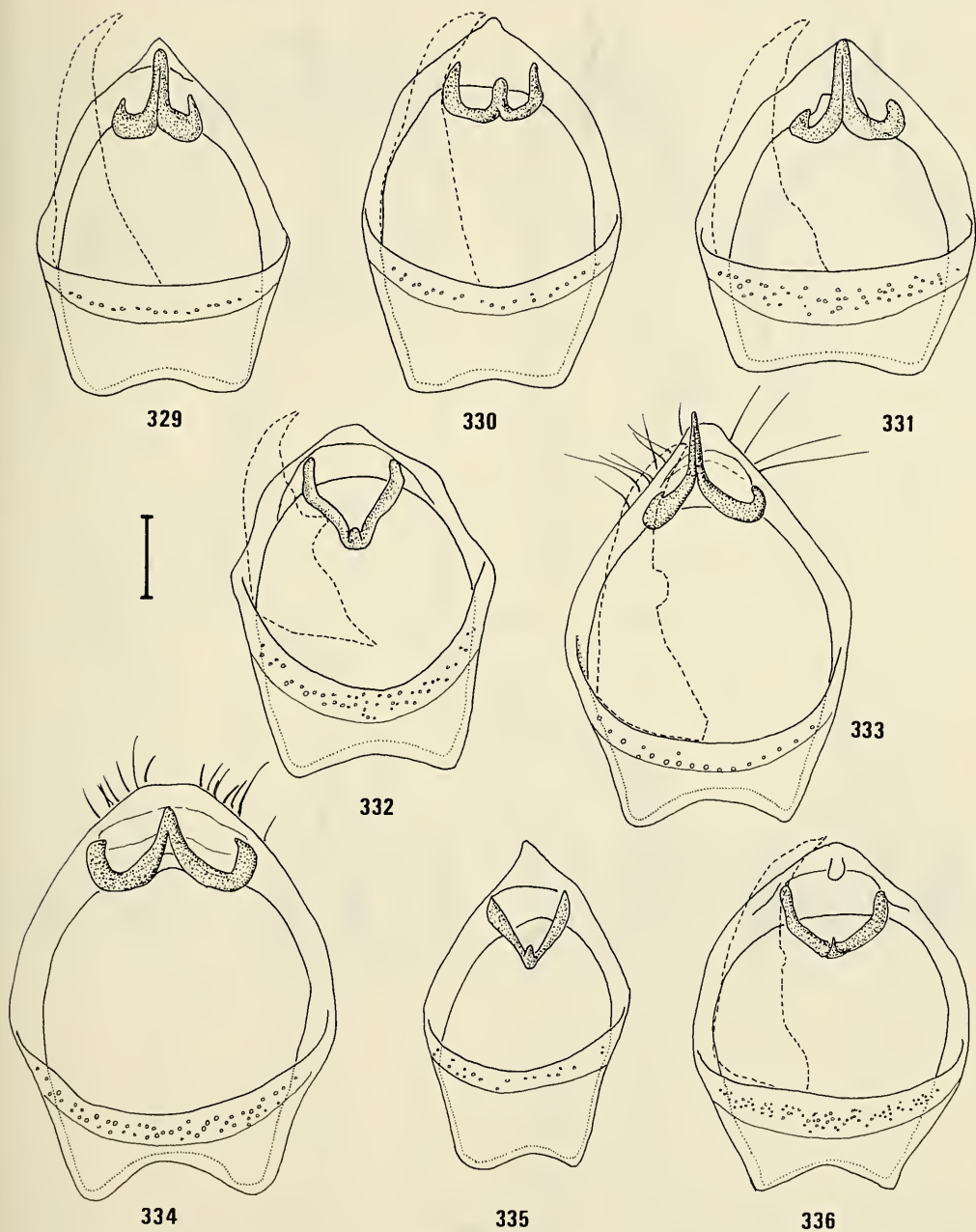

Figs. 329—336. *Ectoedemia* (*Zimmermannia*) spp., ♂ genitalia, capsule, ventral aspect, outline of left valva dotted or omitted. 329, *E. atrifrontella*, slide VU 937, France, Digne; 330, *E. liebwerdella*, slide Carolsfeld-Krause, East Germany, Tharandt; 331, *E. longicaudella*, slide VU 983, France, Digne; 332, *E. hispanica*, slide VU 1830, paratype, Spain, Rubielos de Mora; 333, *E. monemvasiae*, slide VU 476, paratype, Greece, Monemvasia; 334, *E. amani*, slide VU 848, Sweden, Stockholm; 335, *E. nuristanica*, slide MV 5402, holotype; 336, *E. liguricella*, slide VU 929, France, "Nesp.". Scale: 0.1 mm.

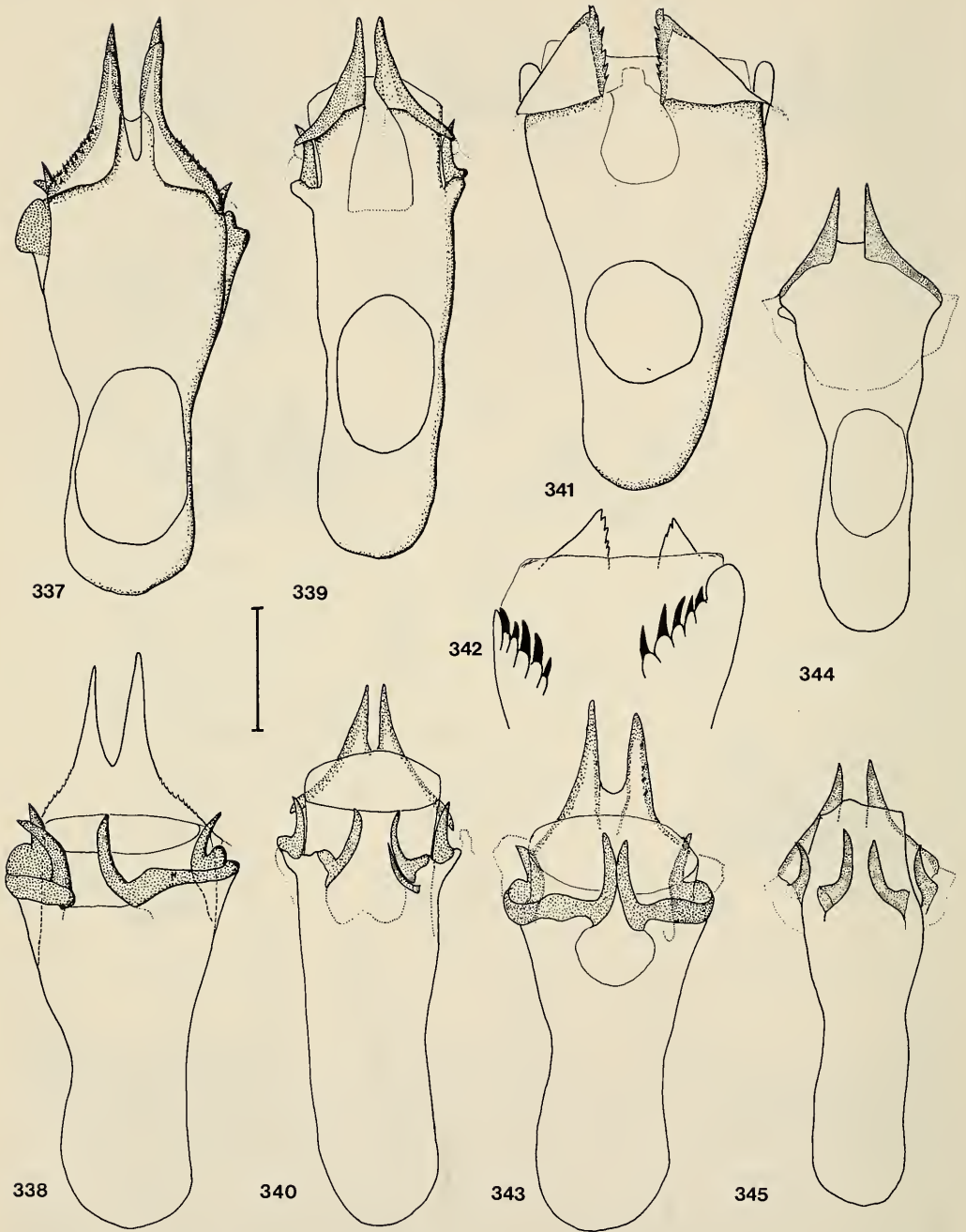

Figs. 337—345. *Ectoedemia* (*Zimmermannia*) spp., ♂, aedeagus, ventral (337, 339, 341, 344) and dorsal aspect (338, 340, 342, 343, 345). 337, 338, *E. atrifrontella*, slide VU 087, Netherlands, Overveen; 339, 340, *E. longicaudella*, slide VU 830, Netherlands, Nijmegen; 341, 342, *E. amani*, slide MV 5752, Austria, Hundsheimer Berg; 343, *E. liebwerdella*, slide Carolsfeld-Krause, East Germany, Tharandt; 344, 345, *E. hispanica*, slide VU 1931, holotype. Scale: 0.1 mm.

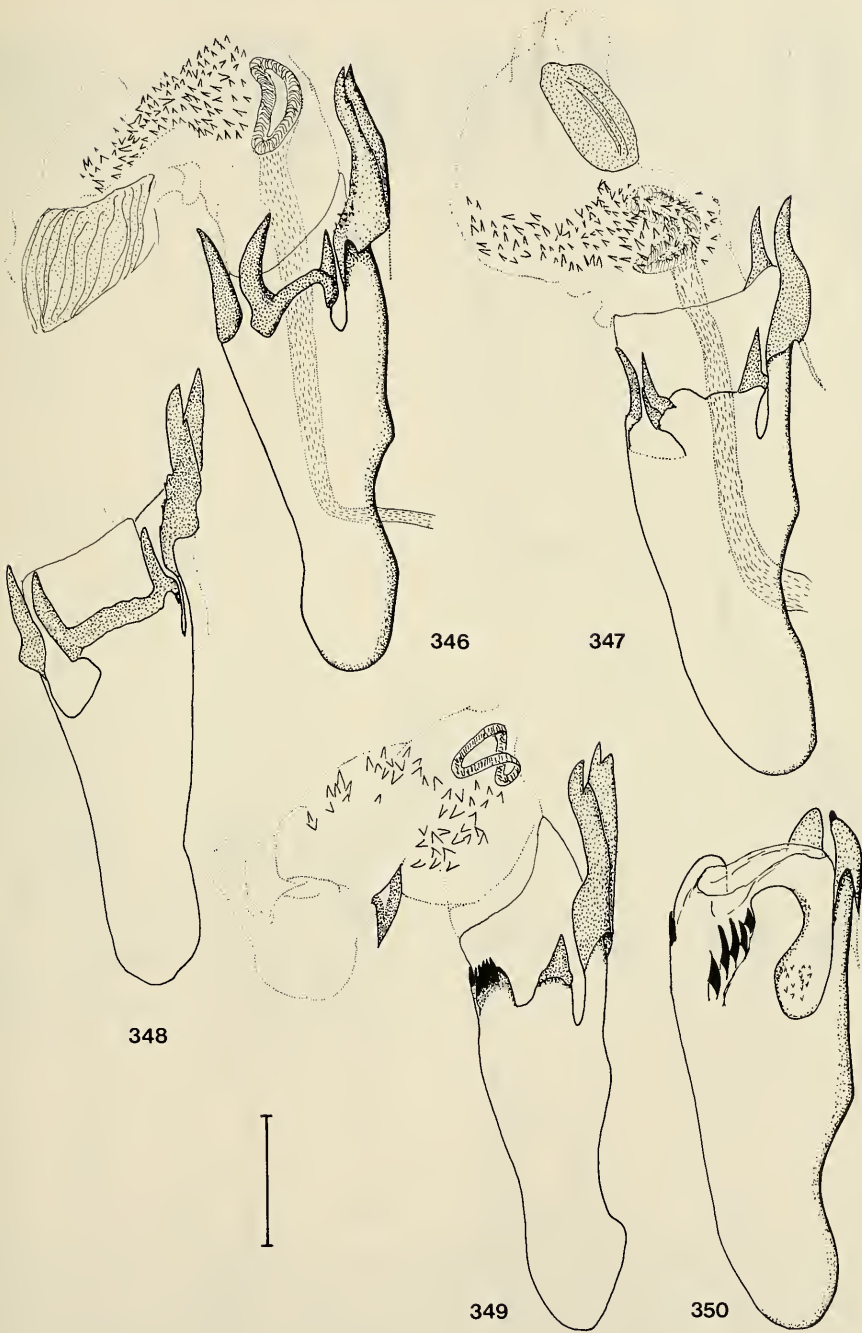

Figs. 346—350. *Ectoedemia* (*Zimmermannia*) spp., ♂, aedeagus, left lateral aspect, in 346, 347 and 349 vesica extracted, in 348 and 350 omitted. 346, *E. atrifrontella*, slide MV 12134, Austria, Gumpoldskirchen; 347, *E. longicaudella*, slide VU 830, Netherlands, Nijmegen; 348, *E. liebwerdella*, slide Carolsfeld-Krause, East Germany, Tharandt; 349, *E. monemvasiae*, slide VU 482, paratype, Greece, Monemvasia; 350, *E. amani*, slide MV 5752, Austria, Hundsheimer Berg. Scale: 0.1 mm.



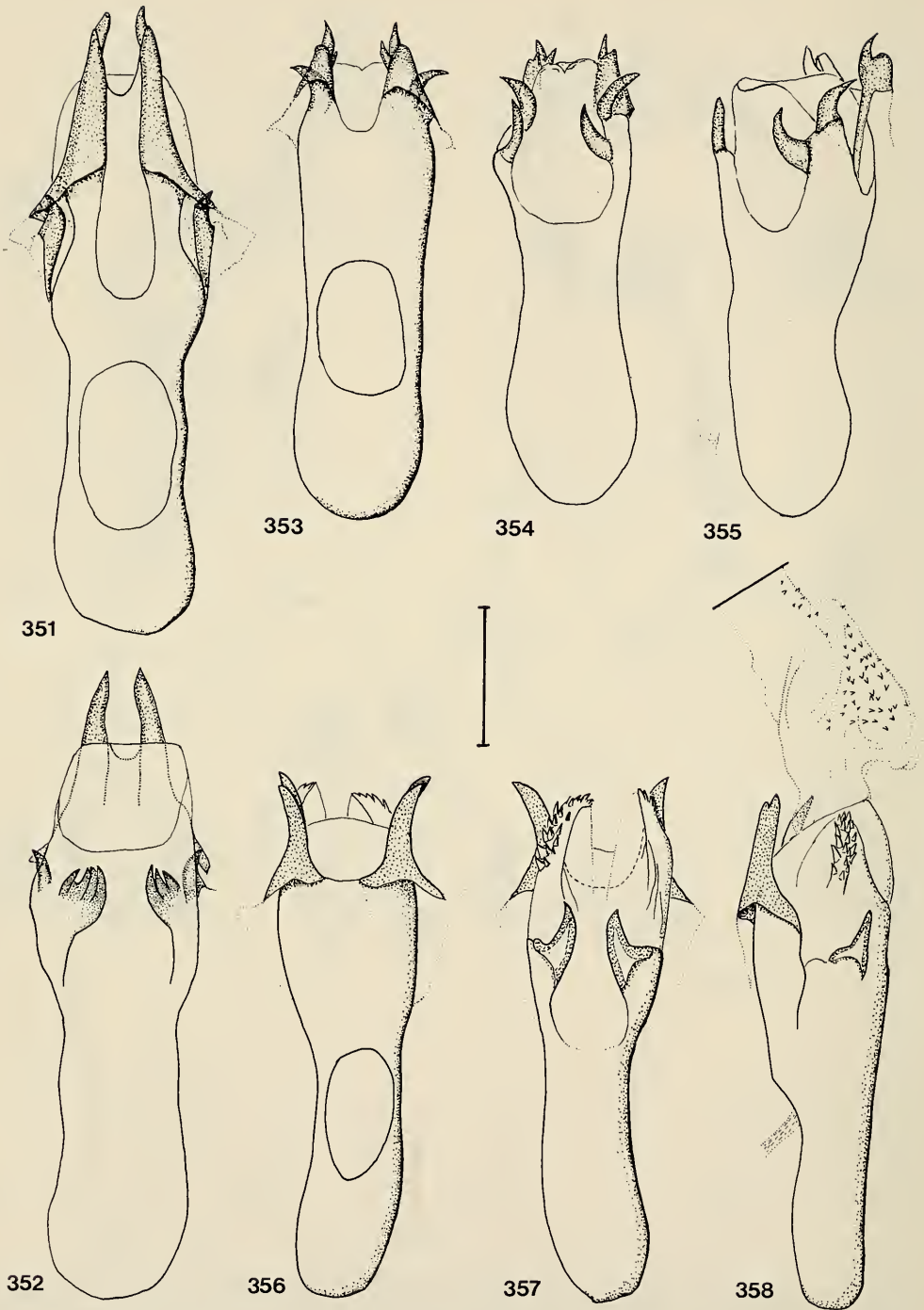

Figs. 351—358. *Ectoedemia* (*Zimmermannia*) spp., ♂, aedeagus, 351, 353, 356, ventral aspect, 352, 354, 357, dorsal aspect; 355, 358, lateral aspect. 351, 352, *E. monemvasiae*, slide VU 470, paratype, Greece, Monemvasia; 353—355, *E. nuristanica*, slide MV 5402, holotype; 356—358, *E. liguricella*, slide MV 5415, Morocco, Ou-kaim'den. Scale: 0.1 mm.

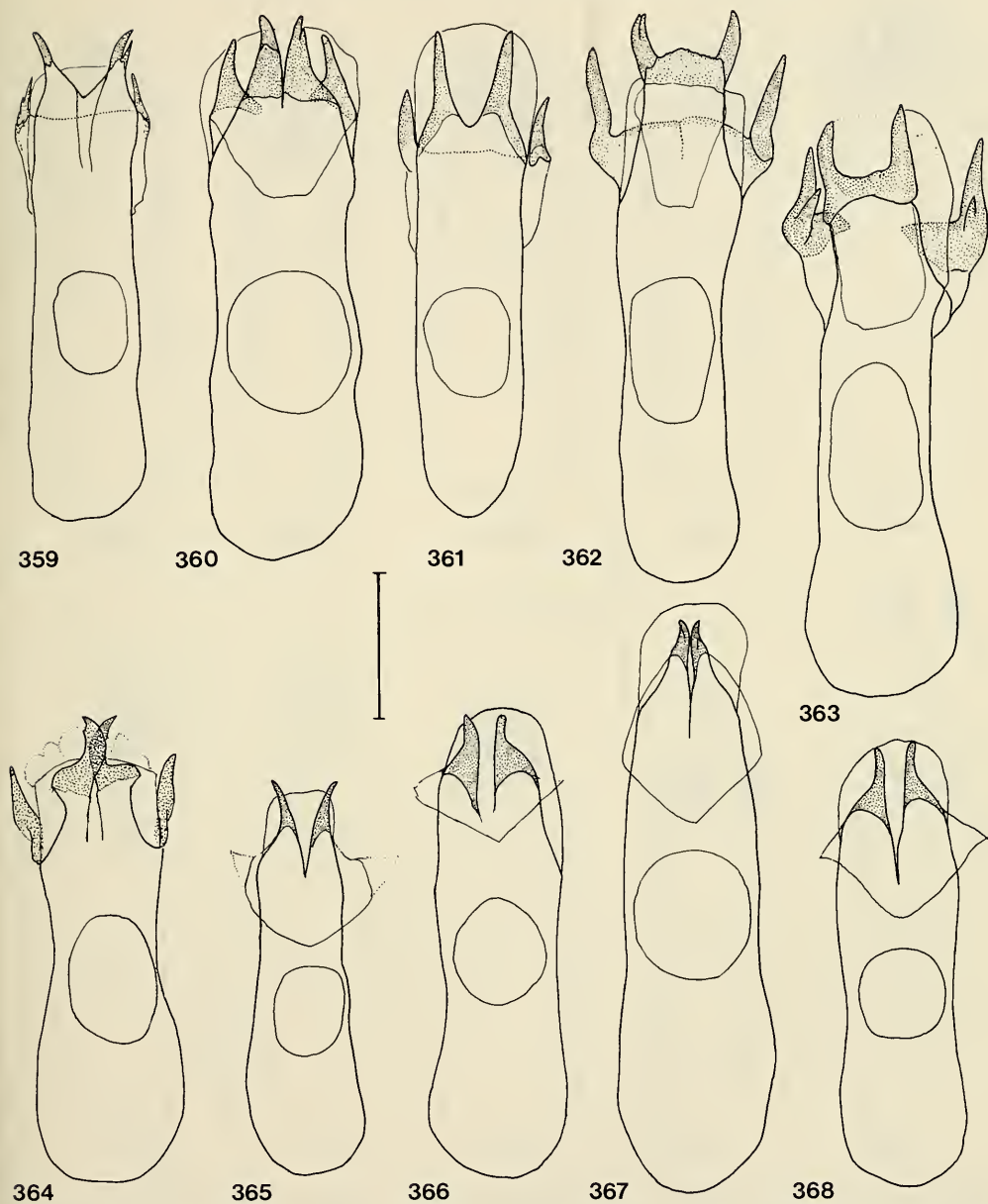

Figs. 359—368. *Ectoedemia* (s.str.) spp., ♂, aedeagus, ventral aspect. 359, *E. intimella*, slide VU 1213, Netherlands, Rockanje. 360, *E. populella*, slide VU 1252, syntype, USA; 361, *E. hannoverella*, slide VU 278, Netherlands, Winterswijk; 362, *E. turbidella*, slide MV 12206, Austria, Linz; 363, *E. klimeschi*, slide VU 1230, Austria, Linz; 364, *E. preisseckeri*, slide MV 12214, lectotype; 365, *E. caradjai*, slide MV 12152, Austria, Hackelsberg; 366, *E. spec.* (specimen 1843), slide VU 1843, Spain, Rubielos de Mora; 367, *E. suberis*, slide VU 1112, France, "Nesp."; 368, *E. andalusiae*, slide VU 1416, Spain, Camino de Ojen. Scale: 0.1 mm.

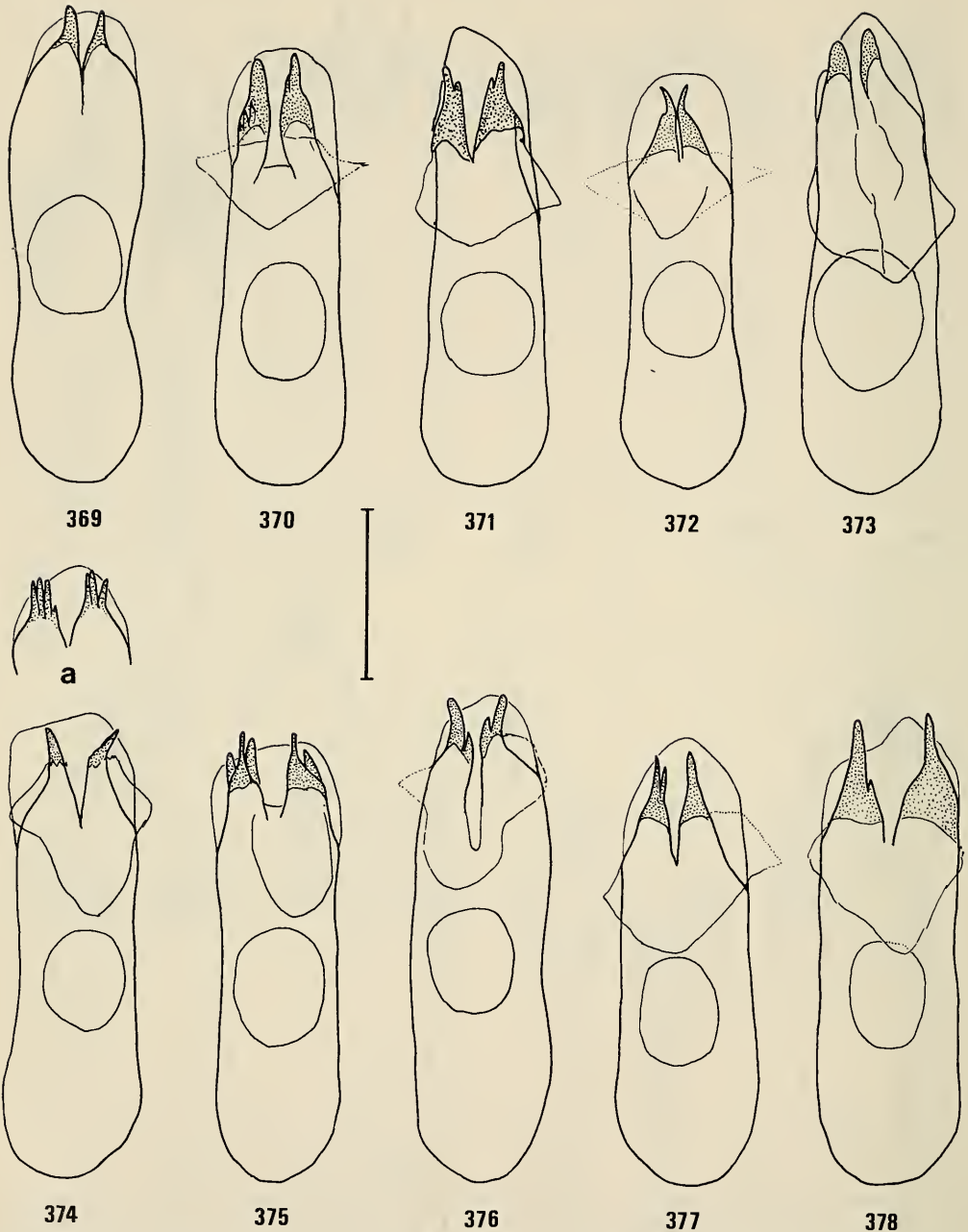

Figs. 369—378. *Ectoedemia* (s.str.) spp., ♂, aedeagus, ventral aspect. 369, *E. aegilopidella*, slide Klim. 4107, holotype; 370, *E. quinquella*, slide VU 1111, England, Rainham; 371, *E. cf. algeriensis*, slide VU 1864, Morocco, Azrou; 372, *E. gilvipennella*, slide VU 1737, Hungary, Törökbálint; 373, *E. leucothorax*, slide VU 1892, holotype; 374, *E. haraldi*, slide VU 1116, France, Villenave d'Ornon, a, idem, tip of aedeagus of paralectotype, slide VU 868; 375, *E. ilicis*, slide VU 1358, lectotype; 376, *E. heringella*, slide BM 22604, France, Corsica; 377, *E. heringella*, slide RM 6666, Cyprus, Arakapos; 378, *E. nigrosarsella*, slide VU 1736, Hungary, Törökbálint. Scale: 0.1 mm.



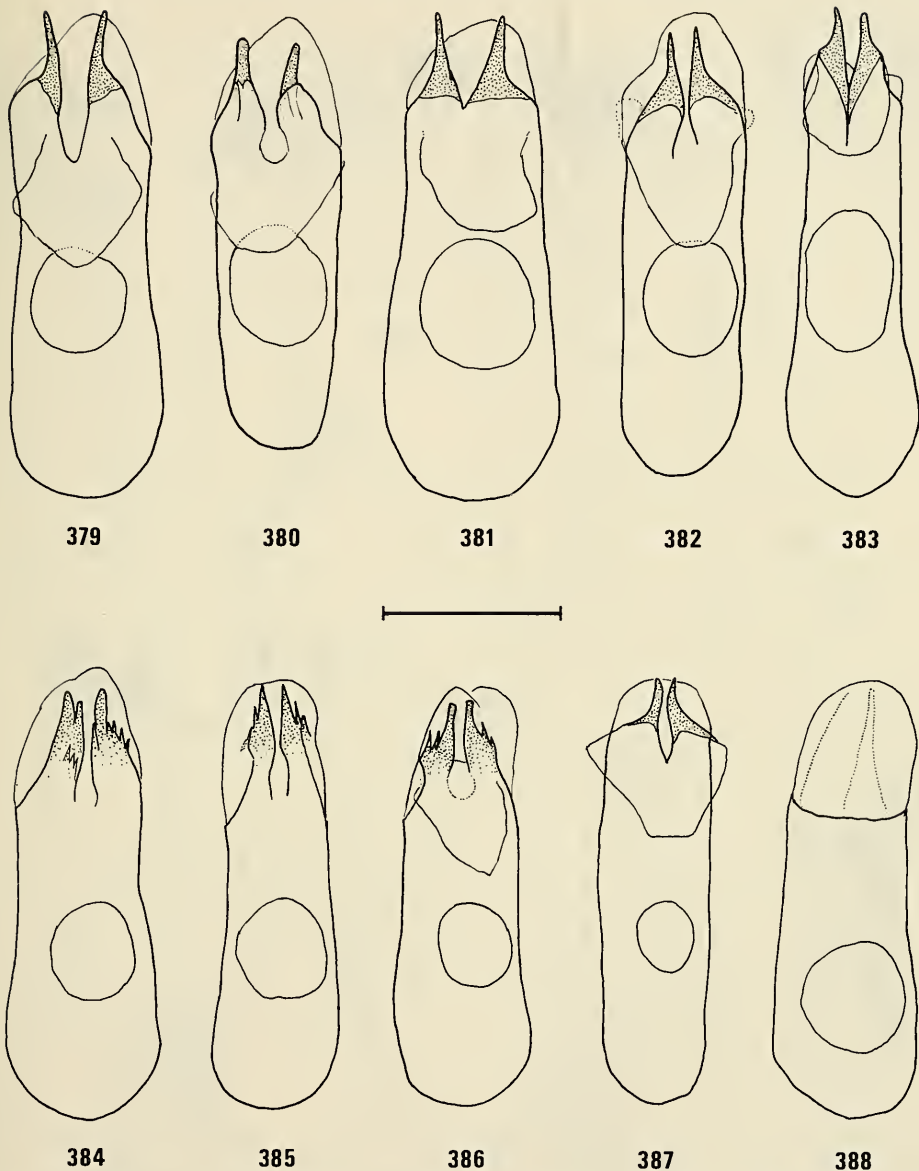

Figs. 379—388. *Ectoedemia* (s.str.) spp., ♂, aedeagus, ventral aspect. 379, *E. albifasciella*, slide VU 1199, Netherlands, Overveen; 380, *E. cerris*, slide VU 1729, Hungary, Szár; 381, *E. pubescivora*, slide VU 1342, paralectotype, Switzerland, Somazzo; 382, *E. cf. contorta*, slide VU 1387, Hungary, Nagykovacsí; 383, *E. terebinthivora*, slide VU 883, Greece, Dhelfoi; 384, *E. subbimaculella*, slide VU 863, Netherlands, Hilversum; 385, *E. beringi*, slide VU 1109, Poland, Bydgoszcz; 386, *E. phyllotomella*, slide Klim. 269, paralectotype, Italy, Ferrania; 387, *E. erythrogonella*, slide VU 1170, paralectotype, France, Vannes; 388, *E. spiraeae*, slide VU 1187, Hungary, Sástó. Scale: 0.1 mm.

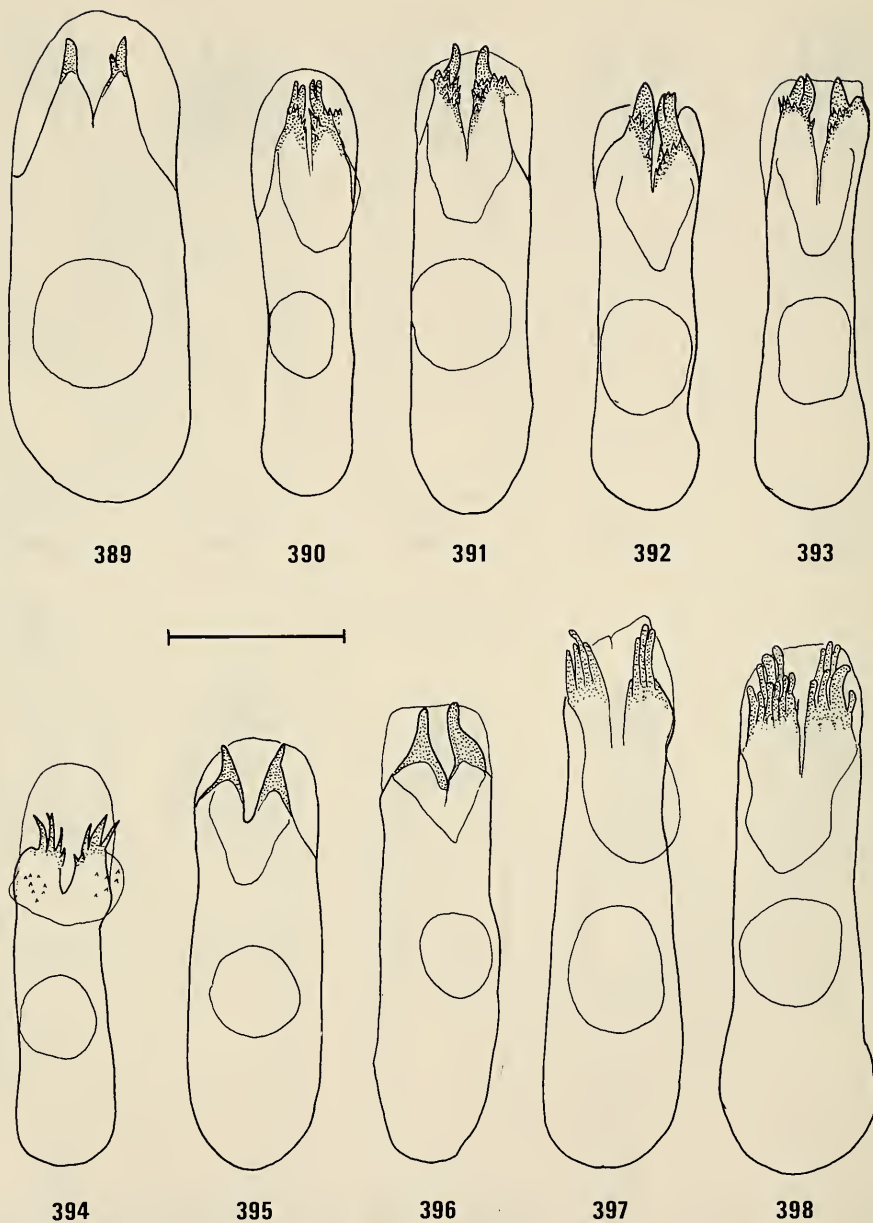

Figs. 389—398. *Ectoedemia* (s.str.) spp., ♂, aedeagus, ventral aspect. 389, *E. hexapetalae*, slide VU 1739, Hungary, Budaörs; 390, *E. angulifasciella*, slide VU 1157, France, Chaville; 391, *E. atricollis*, slide VU 1152, France, Clamart; 392, *E. arcuatella*, slide MV 12184, East Germany, Friedland; 393, *E. rubivora*, slide 1103, Denmark, Faaborg; 394, *E. agrimoniae*, slide VU 642, Greece, Evvoia; 395, *E. spinosella*, slide VU 1137, Netherlands, Gulpen; 396, *E. mahalebella*, slide VU 1750, Hungary, Budaörs; 397, *E. occultella*, slide VU 1226, Netherlands, Rockanje; 398, *E. minimella*, slide VU 1184, Norway, Grøvdalen. Scale: 0.1 mm.

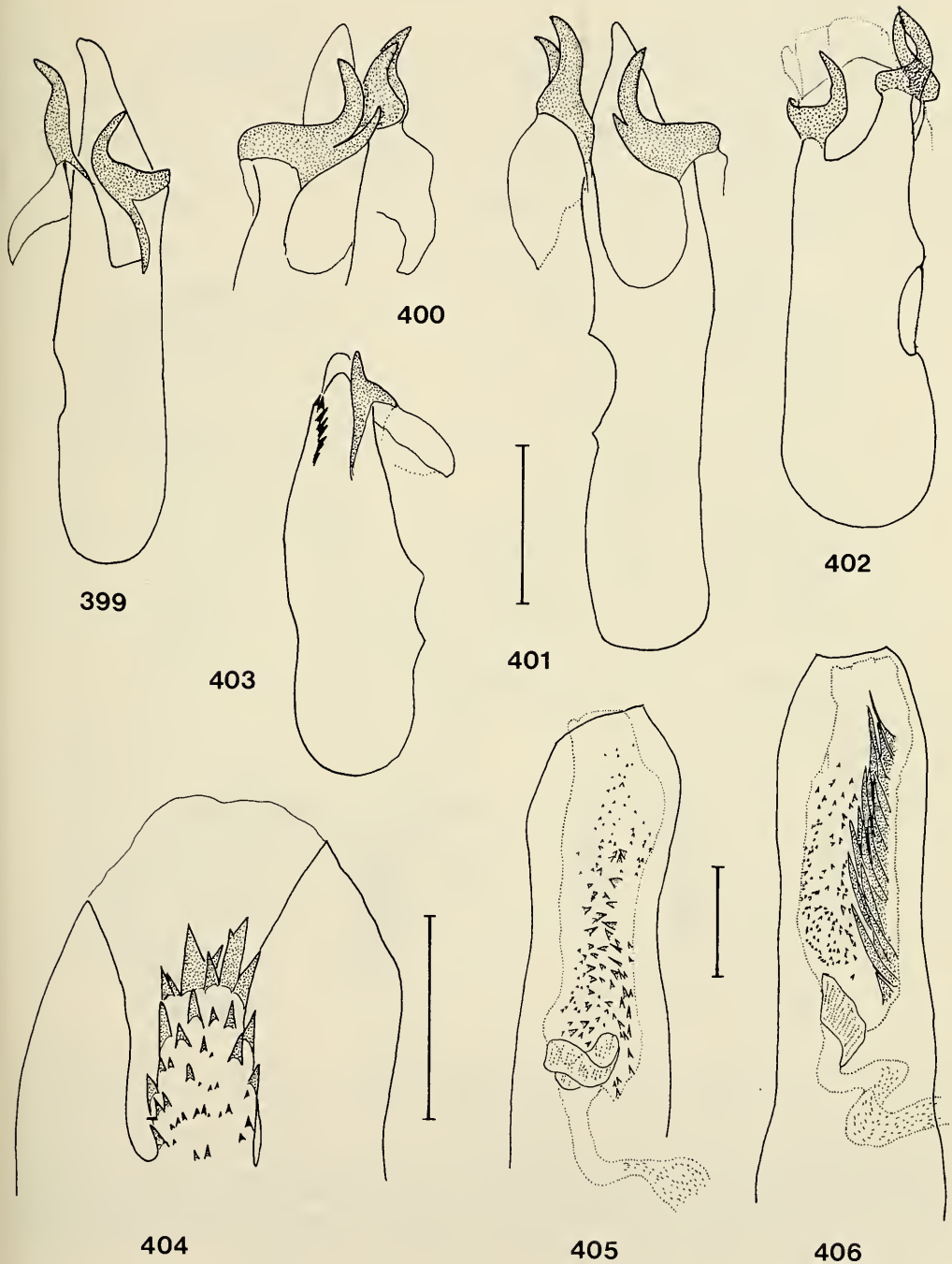

Figs. 399—406. *Ectoedemia* (s.str.) spp., ♂, aedeagus. 399, 401, right lateral aspect, 400, 402, 403, left lateral aspect; 399, *E. hannoverella*, Netherlands, Winterswijk; 400, 401, *E. klimeschi*, slide VU 801, Austria, Linz; 402, *E. preisseckeri*, slide MV 12214, lectotype; 403, *E. hexapetalae*, slide VU 1494, Hungary, Budaörs; 404, *E. hexapetalae*, dorsal aspect, detail of spinose lobe, slide VU 1739, Hungary, Budaörs; 405, 406, Aedeagus with vesica, carinae omitted, ventral aspect; 405, *E. occultella*, slide VU 1226, Netherlands, Rockanje; 406, *E. minima*, slide VU 1184, Norway, Grøvdalen. Scales, 399—403: 0.1 mm, 404: 0.05 mm, 405—406: 0.05 mm.



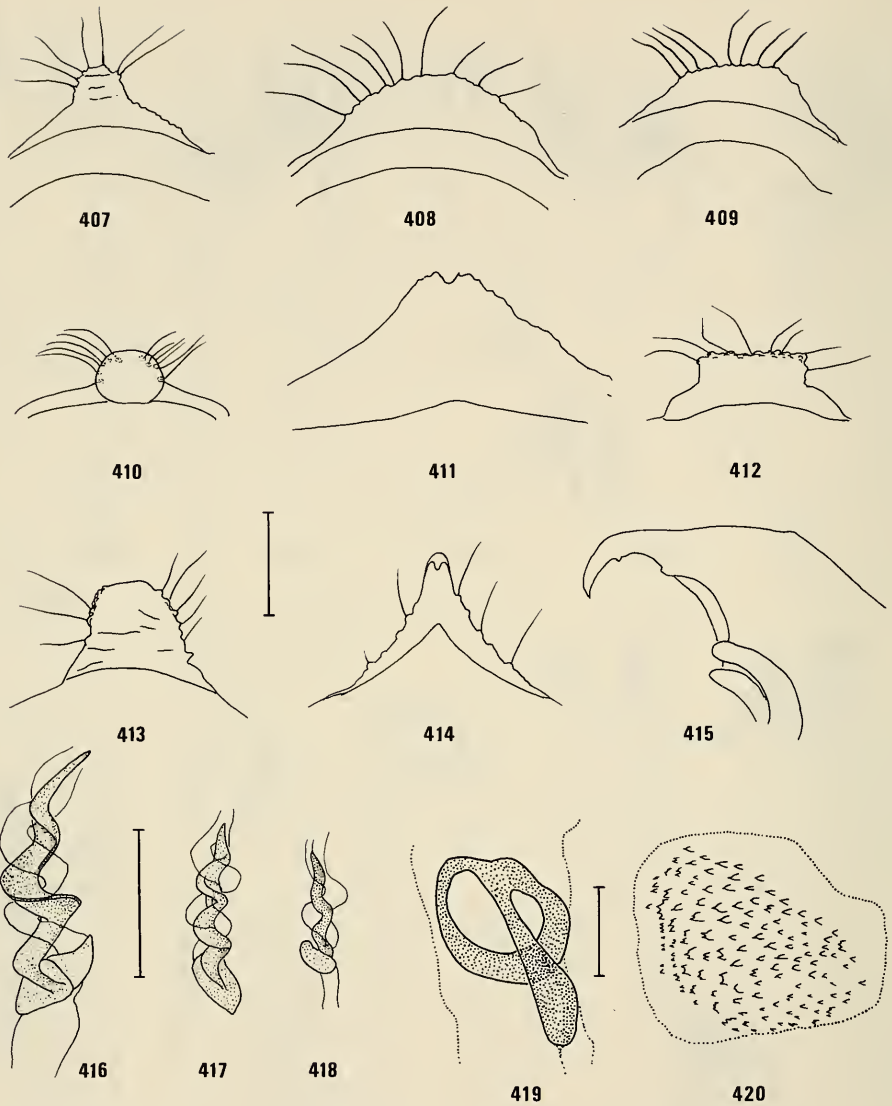

Figs. 407—420. *Ectoedemia* (s.str.) spp., details of genitalia. 407—414, ♂, Tegumen (pseuduncus), ventral aspect. 407, *E. caradjai*, slide VU 1861, Anatolia, Kizilcahamam; 408, *E. suberis*, slide VU 1496, Italy, Sardegna, Mt. Istiddi; 409, *E. andalusiae*, slide VU 1416, paratype, Spain, Camino de Ojen; 410, *E. aegilopidella*, slide Kl. 1298, paralectotype, Greece, Rhodos; 411, *E. quinquella*, slide VU 1111, England, Rainham (slightly squashed); 412, *E. terebinthivora*, slide VU 1249, Greece, Dhelfoi; 413, *E. rubivora*, slide 1001, Netherlands, Winterswijk; 414, *E. minimella*, slide VU 825, Norway, Rennebu; 415, idem, lateral aspect; 416—418, ♀, Ductus spermathecae. 416, *E. albifasciella*, slide VU 893, Greece, Palaiokastron; 417, *E. subbimaculella*, slide VU 638, England, Weeley; 418, *E. beringi*, slide VU 1900, Spain, San Pedro de Alcantara; 419, *E. pubescivora*, vaginal sclerite, ventral aspect, slide VU 1403, Italy, Sardegna, Belvi; 420, *E. algeriensis*, spiculate pouch, dorsal aspect, slide VU 1125, holotype. Scales: 407—415: 0.05 mm; 416—418: 0.1 mm; 419, 420: 0.05 mm.

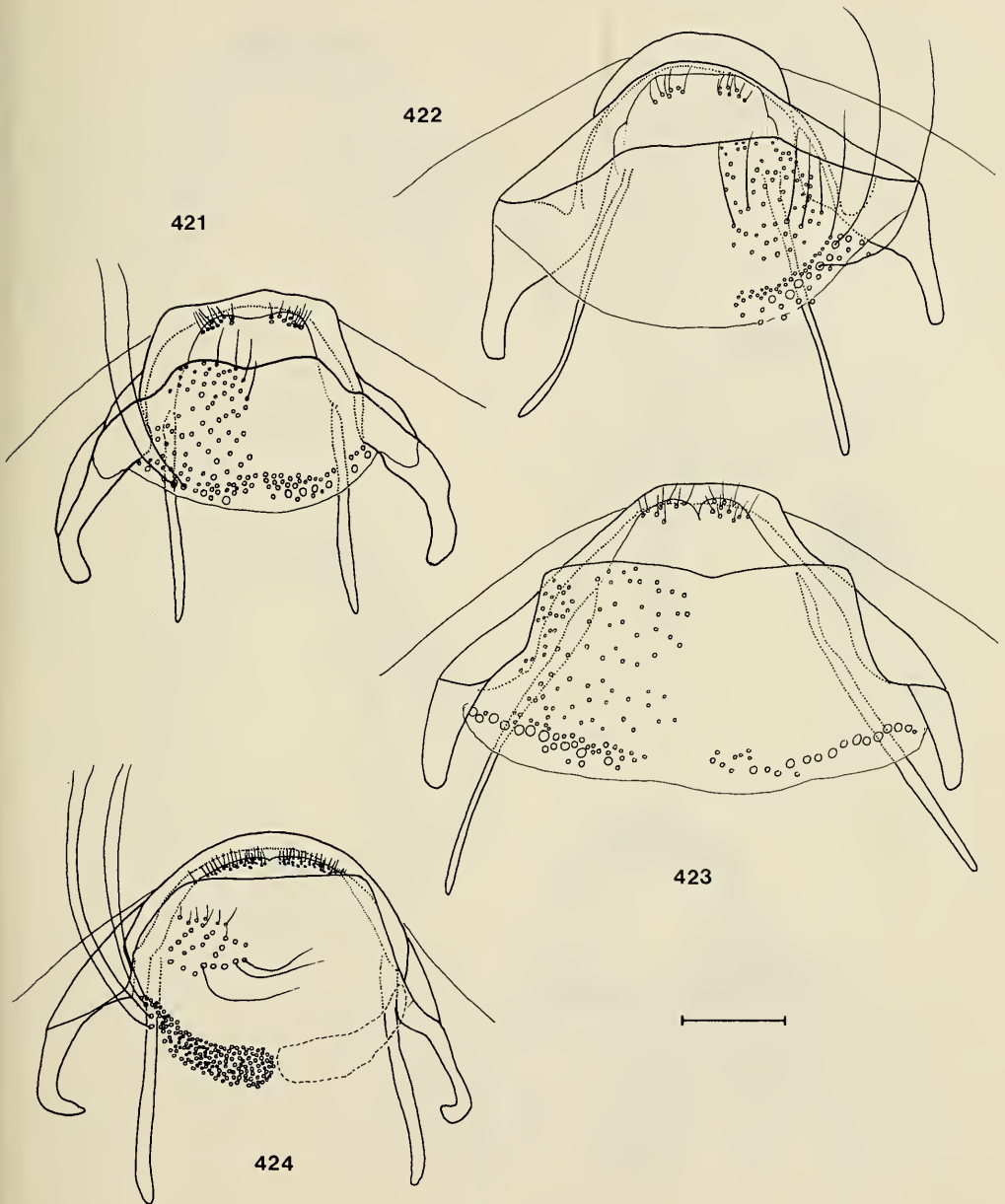

Figs. 421—424. Female postabdomen of *Ectoedemia* (*Zimmermannia*) spp., dorsal aspect. Setal sockets only completely figured on one half of T8. 421, *E. atrifrontella*, slide VU 483, Netherlands, Hilversum; 422, *E. liebwerdella*, slide VU 1873, East Germany, Tharandt; 423, *E. longicaudella*, slide VU 862, Belgium, Aye; 424, *E. monemvasiae*, slide VU 812, paratype, Greece, Monemvasia. Scale: 0.1 mm.

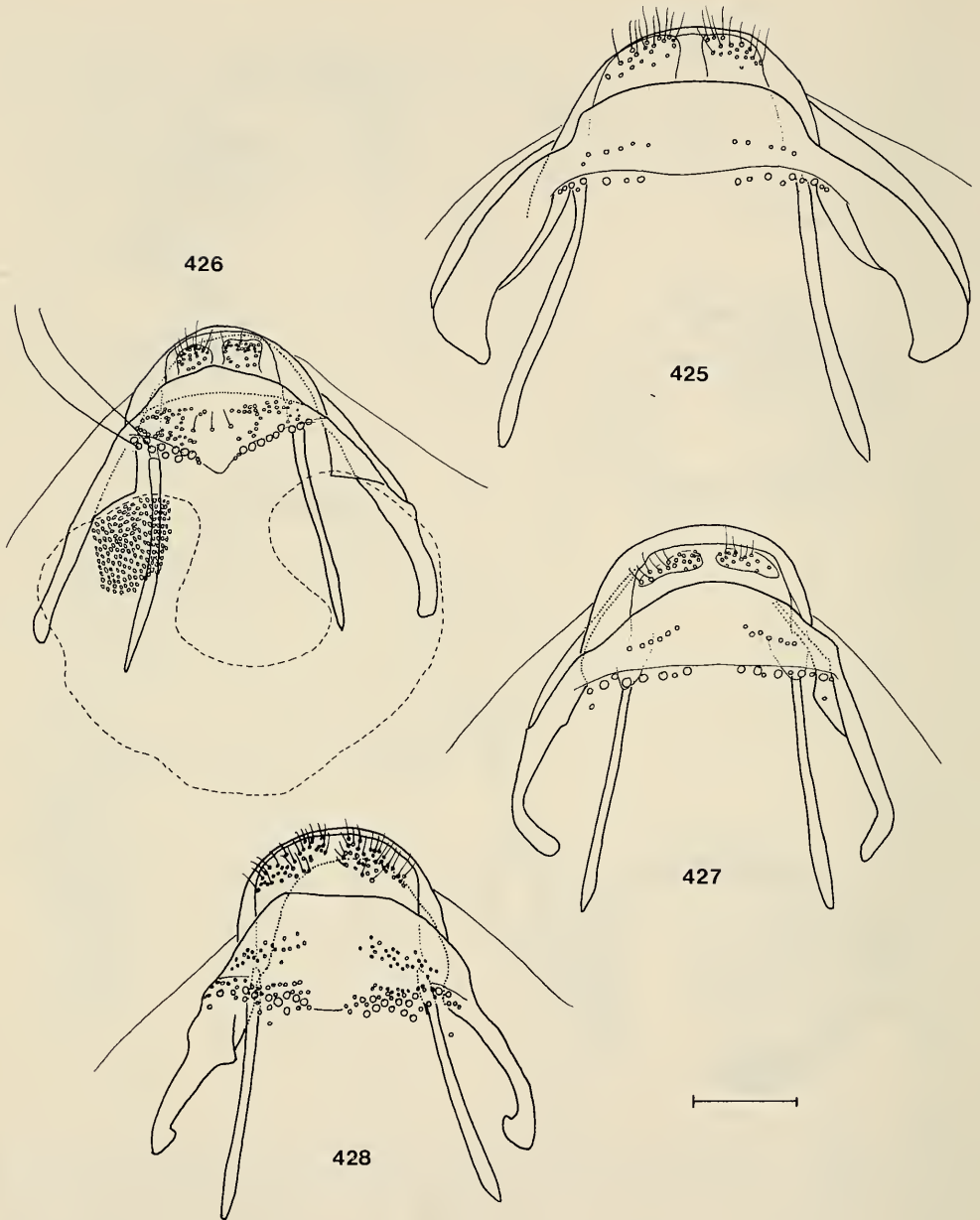

Figs. 425—428. Female postabdomen of *Ectoedemia* (*Zimmermannia*) spp., dorsal aspect. 425, *E. amani*, slide MV 1723 (slightly squashed), Yugoslavia, Skopje; 426, *E. nuristanica*, slide MV 12141, paratype, setal patch on T7 indicated by broken line, setal sockets only partly figured; 427, *E. liguricella*, slide BM 22669, Spain, Sierra Alfacar; 428, *E. liguricella*, aberrant specimen, slide MV 12140, Morocco, Oukaim'den. Scale: 0.1 mm.



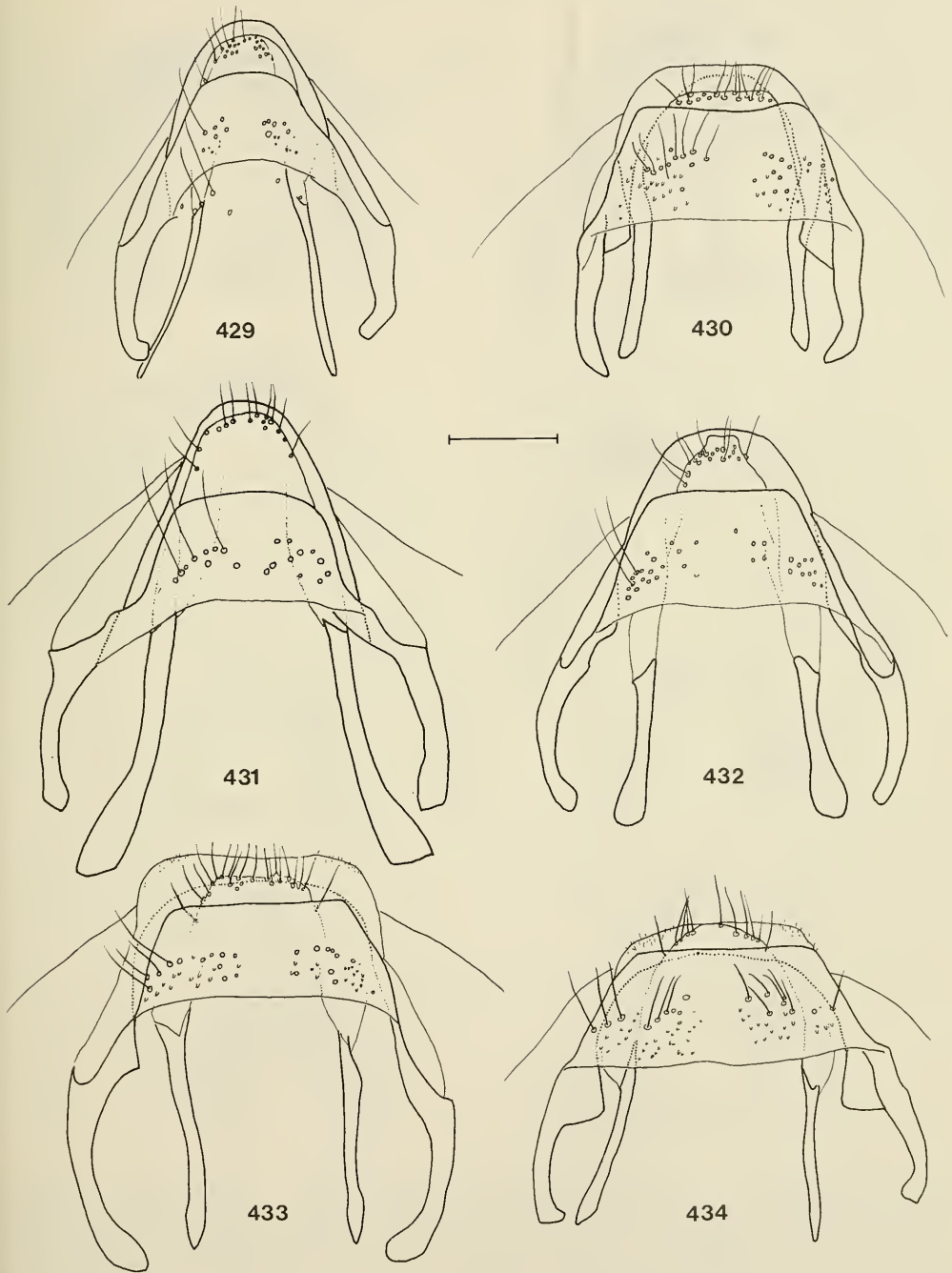

Figs. 429—434. Female postabdomen of *Ectoedemia* (s.str.) spp., *populella* group. 429, *E. intimella*, slide VU 1254, England, Earls Colne; 430, *E. hannoverella*, slide MV 12205, East Germany, Bautzen; 431, *E. turbidella*, slide VU 1491, Netherlands, Santpoort; 432, *E. cf. turbidella*, slide VU 1492, Iran, Keredj; 433, *E. klimeschi*, slide VU 1231, Austria, Linz; 434, *E. argyropeza*, slide VU 1918, West Germany, Heidelberg. Scale: 0.1 mm.

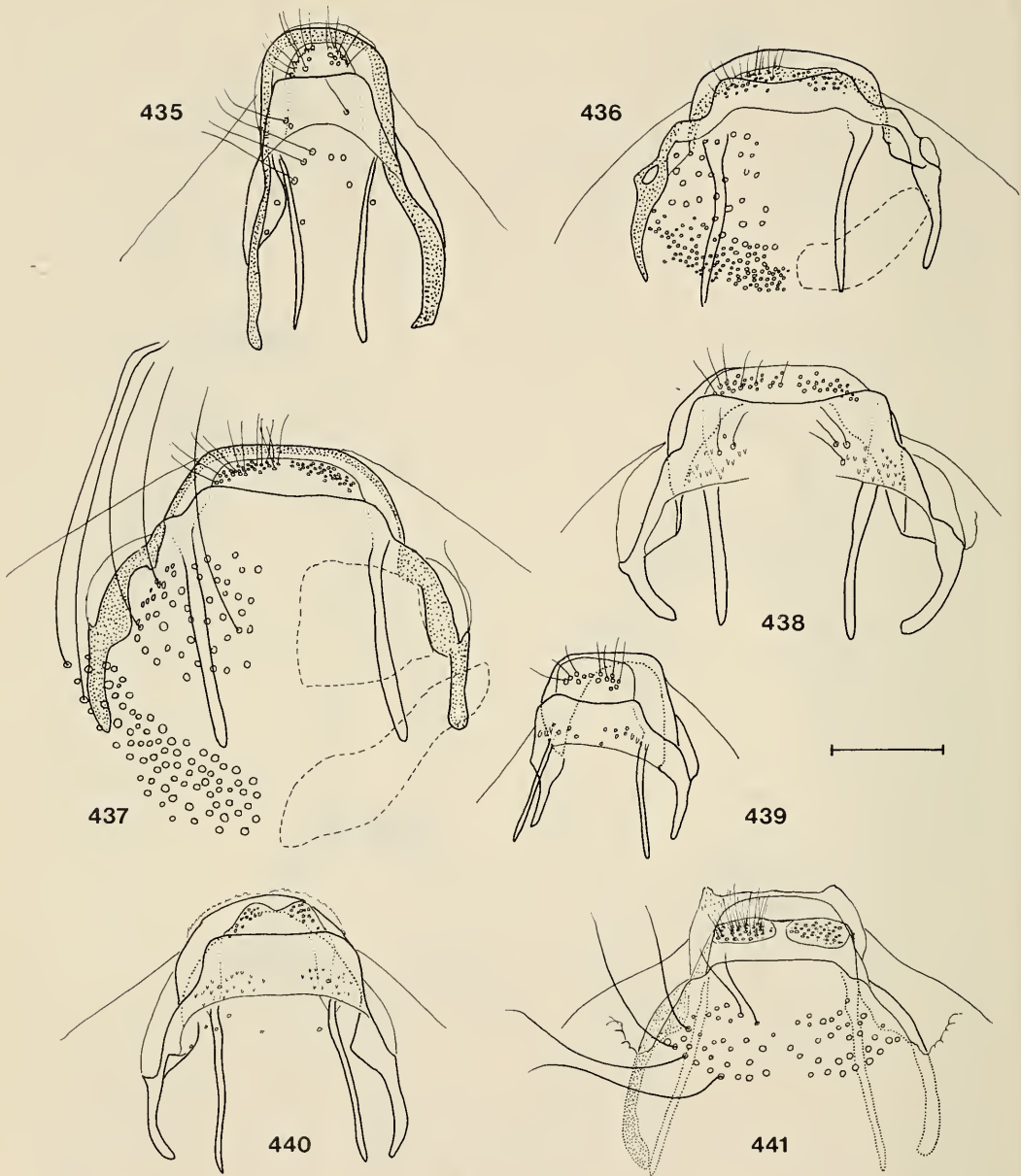

Figs. 435—441. Female postabdomen of *Ectoedemia* (s.str.) spp., in 436 and 437 setal sockets only completed in right half of T8. 435, *E. preisseckeri*, slide MV 12215, paralectotype, Austria, Klosterneuburg; 436, *E. caradjai*, slide VU 1447, USSR, Babince; 437, *E. suberis*, slide VU 899, France, Golfe Juan; 438, *E. andalusiae*, slide VU 1417, paratype, Spain, Camino de Ojen; 439, *E. aegilopidella*, slide VU 1390, paratype, Greece, Rhodos; 440, *E. quinquella*, slide VU 898, England, Rainham; 441, *E. algeriensis*, slide VU 900, paratype, Algeria, Aurès. Scale: 0.1 mm.

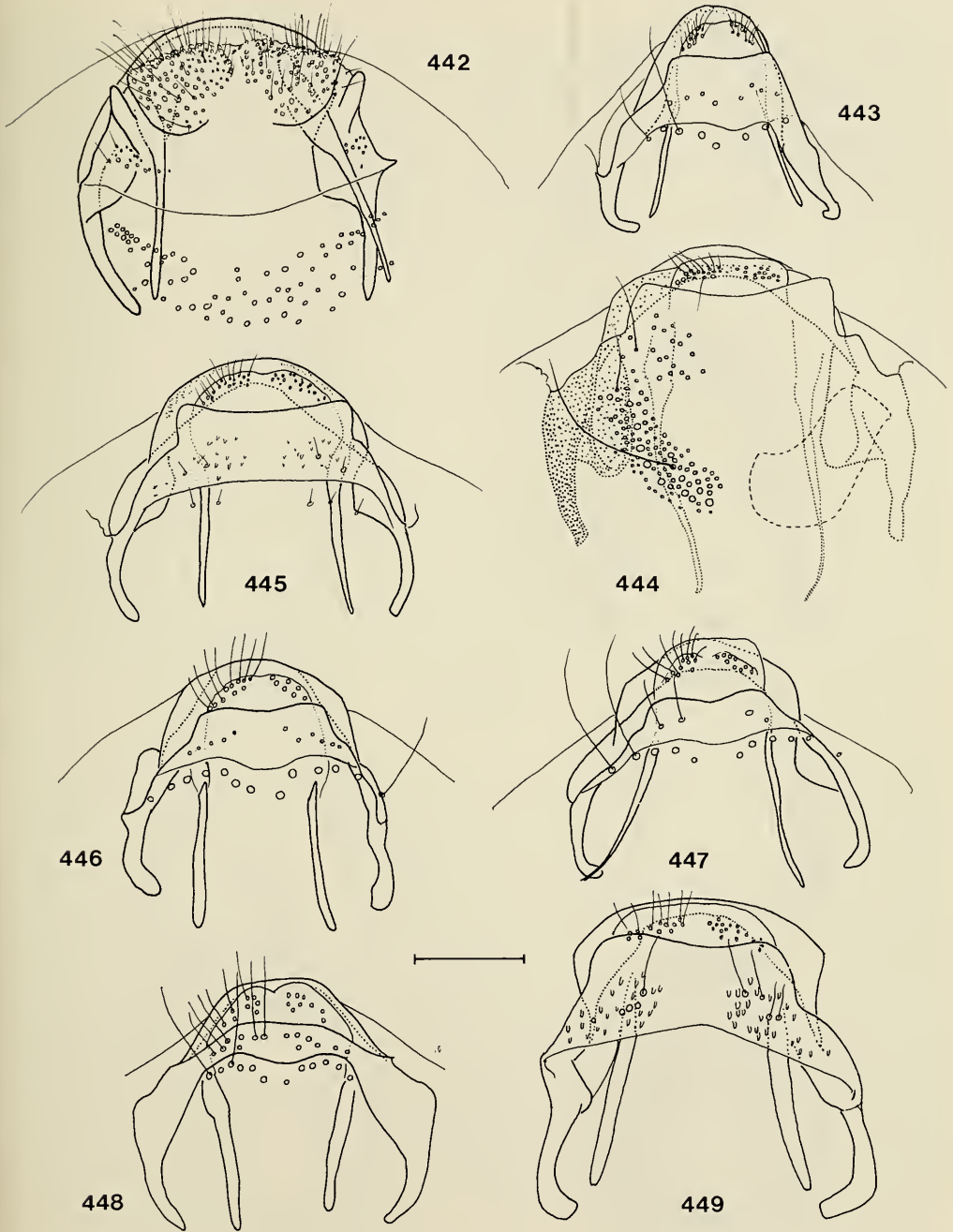

Figs. 442—449. Female postabdomen of *Ectoedemia* (s.str.) spp., *subbimaculella* group. 442, *E. spec.* near *algeriensis*, slide VU 1897, Spain, N. of Benahavis; 443, *E. gilvipennella*, slide VU 1380, Hungary, Törökbálint; 444, *E. leucothorax*, slide Klim. 774, paratype, Spain, Marbella; 445, *E. baraldi*, slide VU 901, paralectotype, France, Angoulême; 446, *E. ilicis*, slide VU 1352, France, "Nesp."; 447, *E. beringella*, slide VU 902, paralectotype, Italy, Sicilia, Partinico; 448, *E. beringella*, slide RM 6667, Cyprus, Arakapos; 449, *E. alnifoliae*, slide RM 6572, holotype. 448 and 449 slightly squashed. Scale: 0.1 mm.



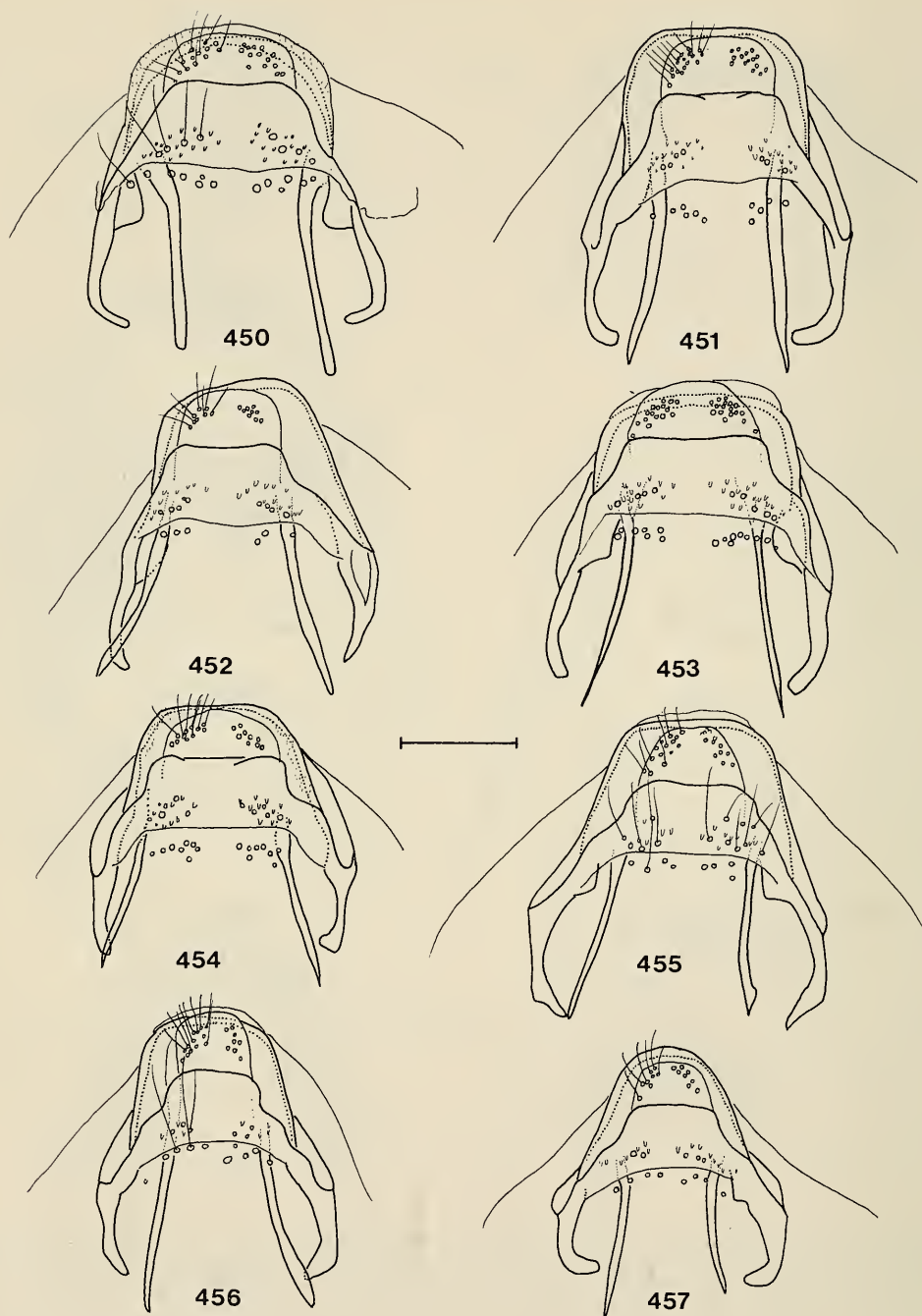

Figs. 450—457. Female postabdomen of *Ectoedemia* (s.str.) spp., *subbimaculella* group. 450, *E. nigrosparsella*, slide VU 1379, Hungary, Törökbálint; 451, *E. albifasciella*, slide VU 892, Netherlands, Hilversum; 452, *E. ceris*, slide VU 1730, Hungary, Szár; 453, *E. pubescivora*, slide VU 1403, Italy, Sardegna, Belvi; 454, *E. contorta*, slide VU 1388, holotype; 455, *E. subbimaculella*, slide VU 891, Netherlands, Hilversum; 456, *E. heringi*, slide VU 895, paralectotype of *N. zimmermanni*, Czechoslovakia, Libochowan; 457, *E. phyllotomella*, slide VU 1392, paralectotype, Italy, Ferrania. Scale: 0.1 mm.

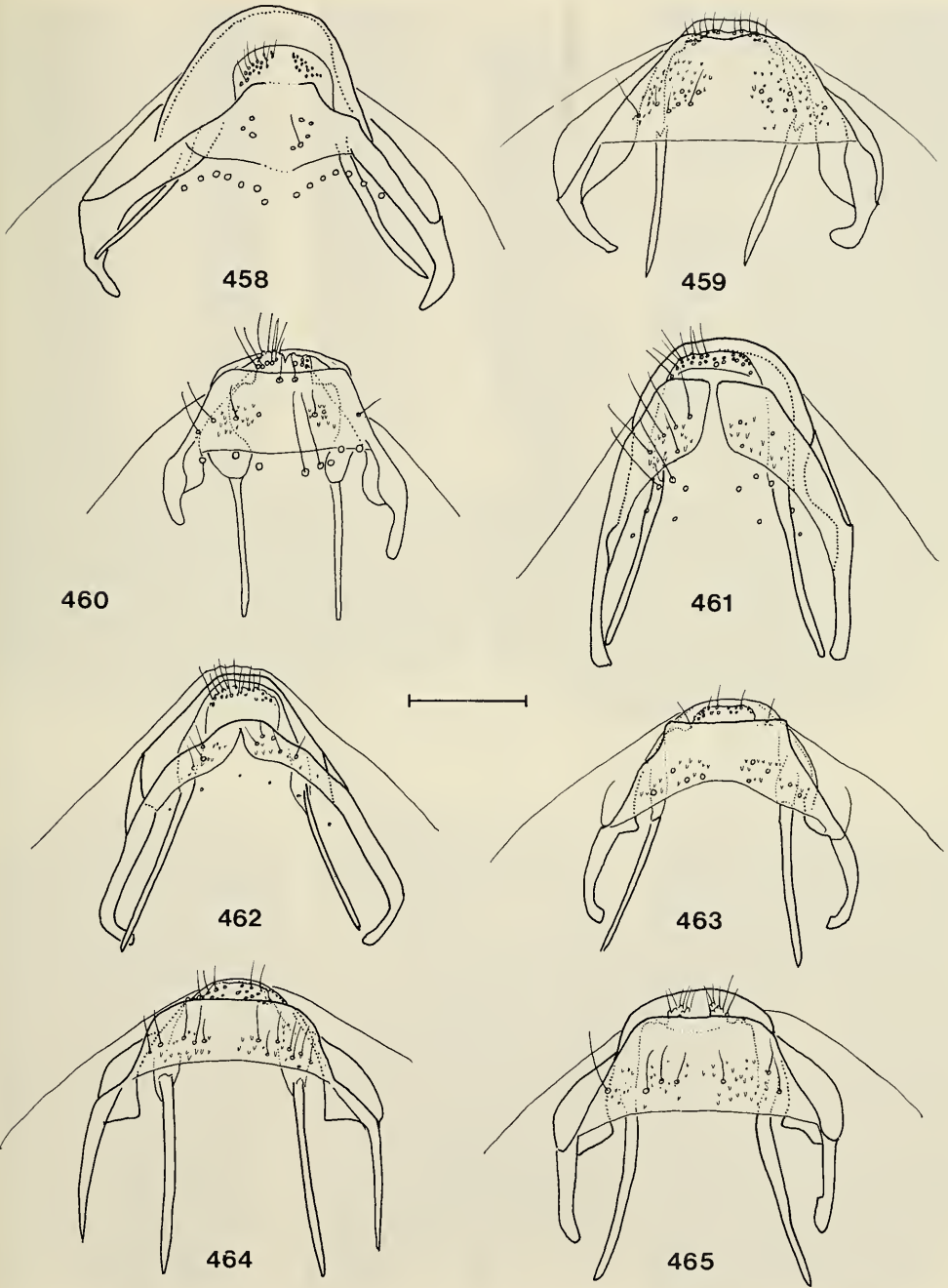

Figs. 458—465. Female postabdomen of *Ectoedemia* (s.str.) spp. 458, *E. spec.* (specimen 1375), slide VU 1375, Iran, W. of Shiraz; 459, *E. terebinthivora*, slide VU 1248, Greece, Dhelfoi; 460, *E. erythrogenella*, slide BM 22675, France, Cannes; 461, *E. spiraeae*, slide VU 1868, paratype, Czechoslovakia, Čingov; 462, *E. agrimoniae*, slide VU 1136, Greece, Katsika; 463, *E. hexapetalae*, slide VU 1742, Hungary, Budapest; 464, *E. angulifasciella*, slide VU 969, Netherlands, Ootmarsum; 465, *E. atricollis*, slide VU 968, Netherlands, Ankeveense Plassen. Scale: 0.1 mm.

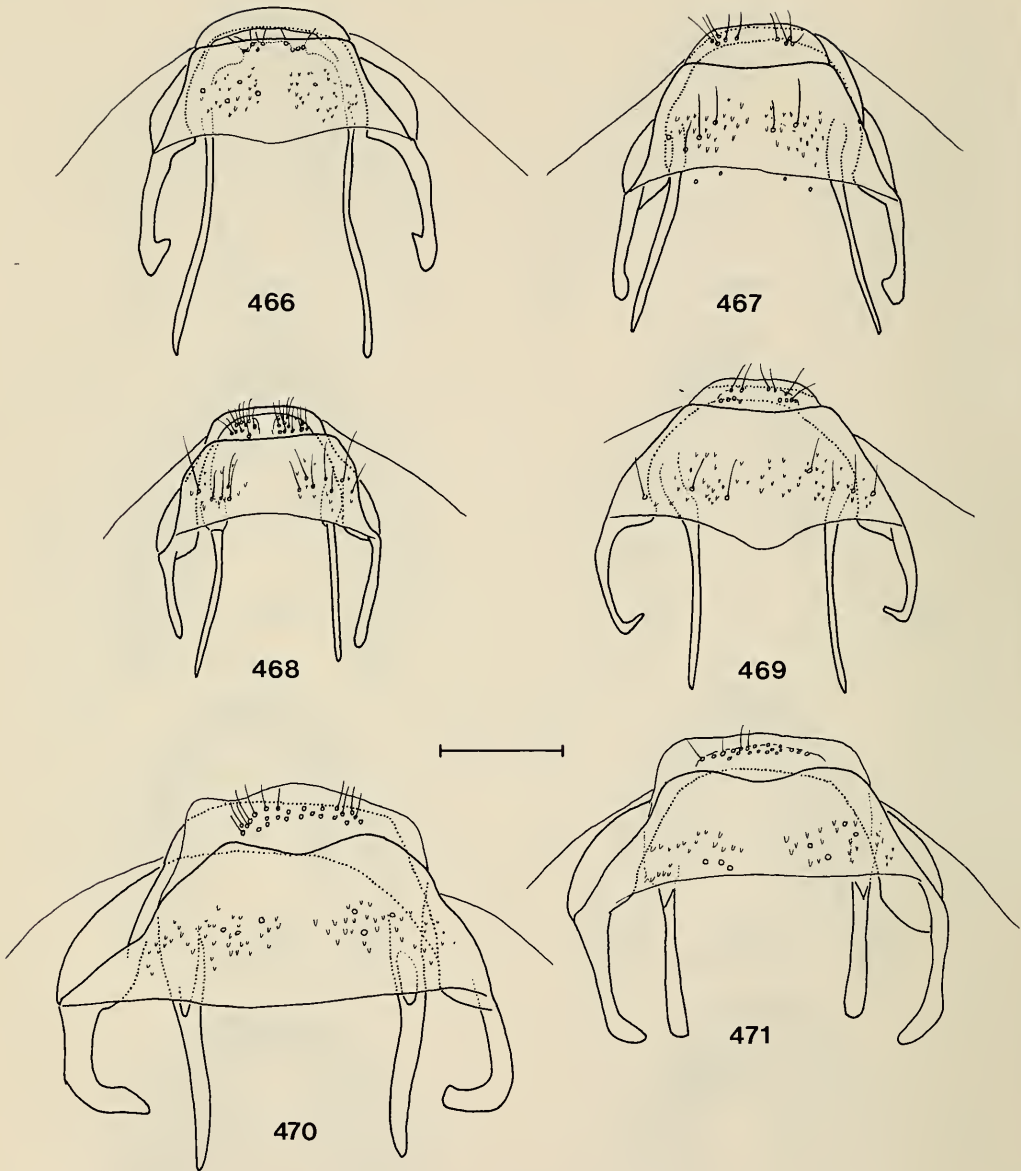

Figs. 466—471. Female postabdomen of *Ectoedemia* (s.str.) spp. 466, *E. arcuatella*, slide BM 22679, paralectotype, Switzerland, Zürich; 467, *E. rubivora*, slide VU 649, Netherlands, Winterswijk; 468, *E. spinosella*, slide VU 947, lectotype; 469, *E. mahalebella*, slide VU 999, France, St. Thibaud-de-Couz; 470, *E. occultella*, slide VU 1183, Austria; 471, *E. minimella*, slide VU 1220, France, Pralognan. Scale: 0.1 mm.



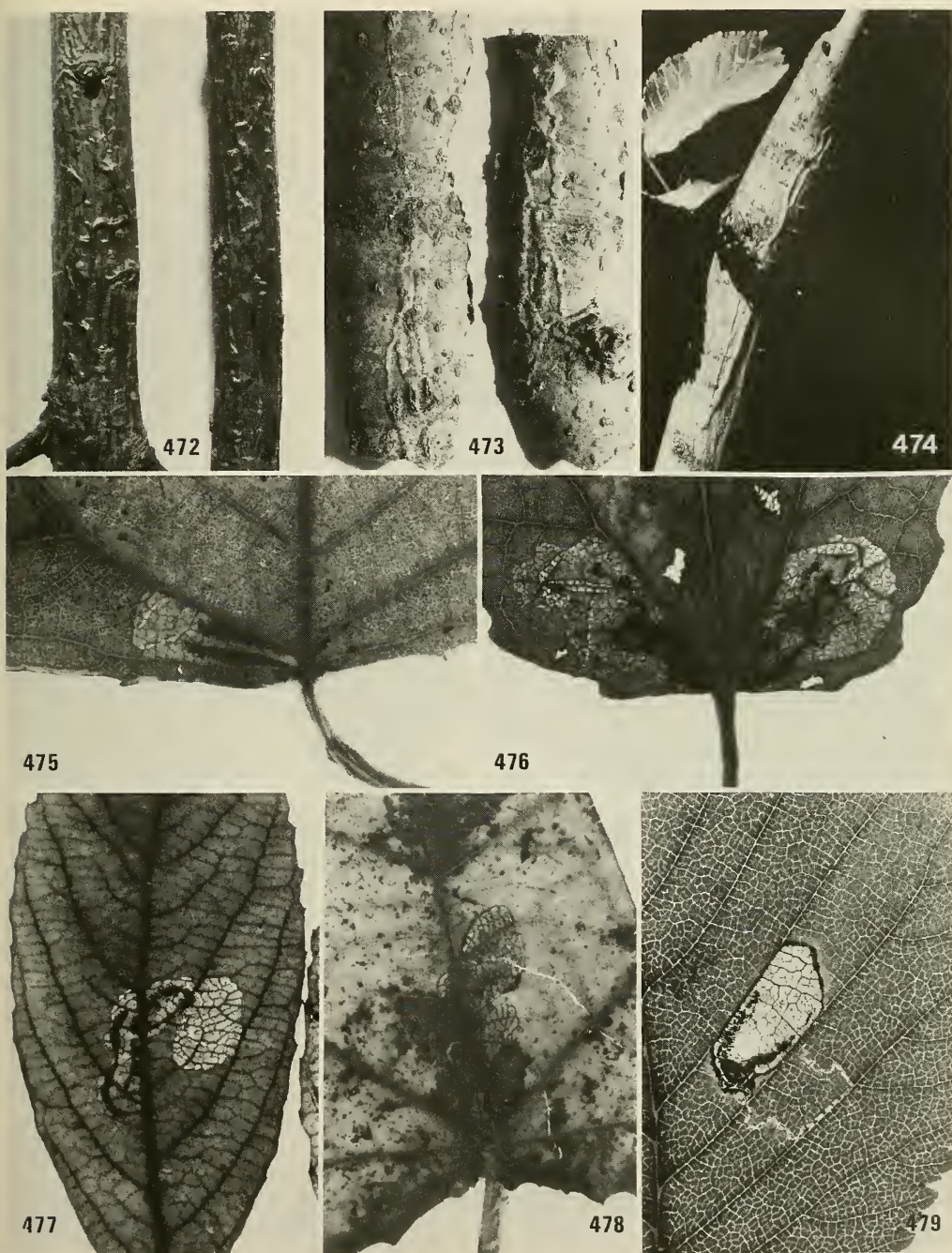

Figs. 472—479. Mines of *Ectoedemia*. 472, *E. atrifrontella* on *Quercus robur* (dried branch), Netherlands, Hollandse Rading; 473, *E. liebwerdella* on *Fagus sylvatica* (dried bark), France, le Sappey-en-Chartreuse; 474, *E. amani* on *Ulmus* sp., Sweden, from colour-slide R. Johansson; 475, *E. hamoverella* on *Populus × canadensis*, Netherlands, Bunde; 476, *E. turbidella* on *Populus canescens*, England, Loughton; 477, *E. intimella* on *Salix cinerea*, Netherlands, Rockanje; 478, *E. klimeschi* on *Populus alba*, Austria, Linz; 479, *E. preisseckeri* on *Ulmus* sp., Austria, Wien.



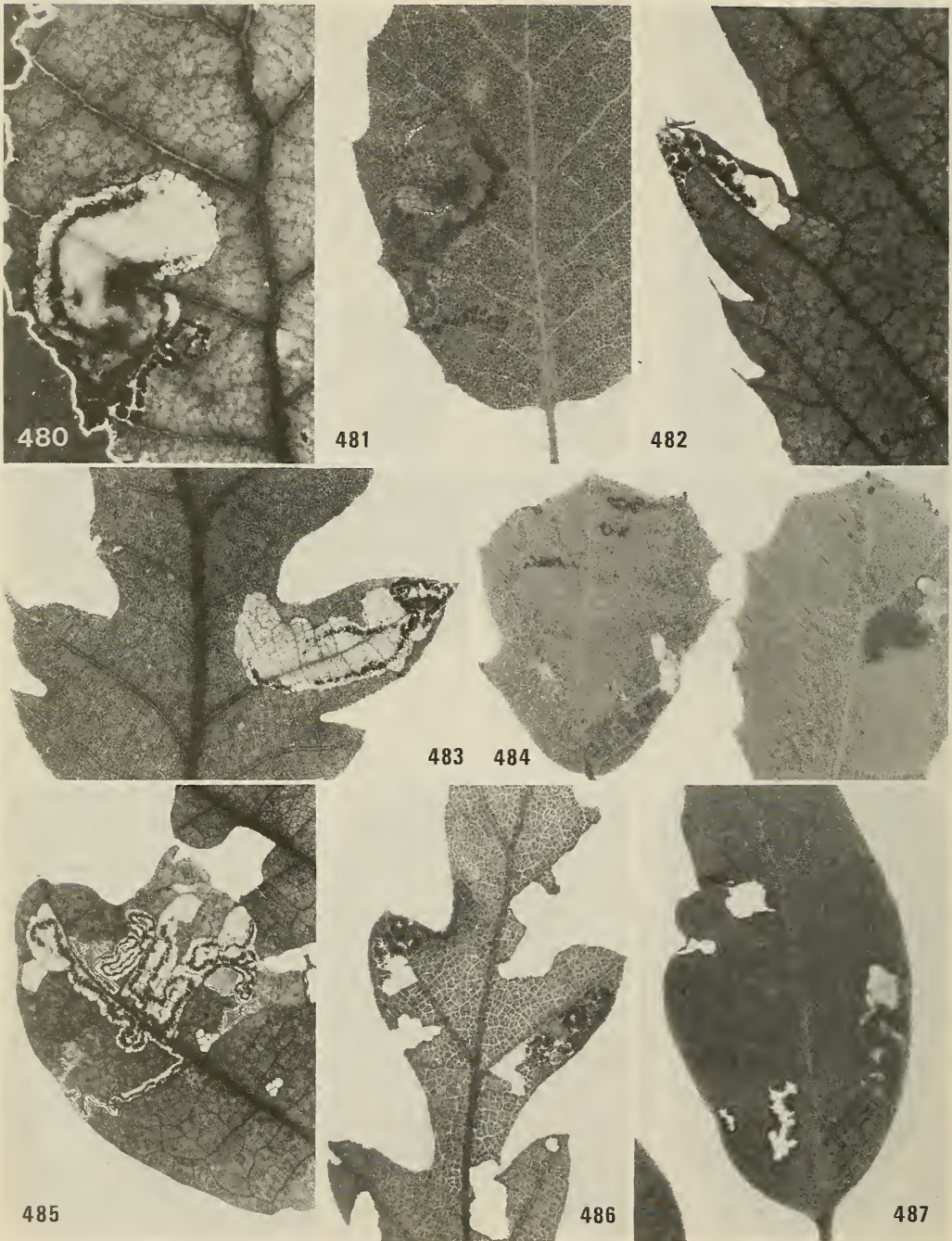

Figs. 480—487. Mines of *Ectoedemia* on leaves of *Quercus* spp. 480, *E. suberis* on *Q. suber*, Spain, Sierra Blanca; 481, *E. suberis* or *andalusiae* on *Q. coccifera*, Spain, Marbella; 482, *E. aegilopidella* on *Q. macrolepis*, Greece, Rhodos; 483, *E. caradjai* on *Q. pubescens*, Greece, Oiti Oros; 484, *E. algeriensis* on *Q. rotundifolia*, Algeria, Arris; 485, *E. quinquella* on *Q. robur*, England, Herringswell; 486, *E. gilvipeumella* on *Q. cerris*, Austria, Loreto; 487, *E. haraldi* on *Q. ilex*, France, Roquefort.



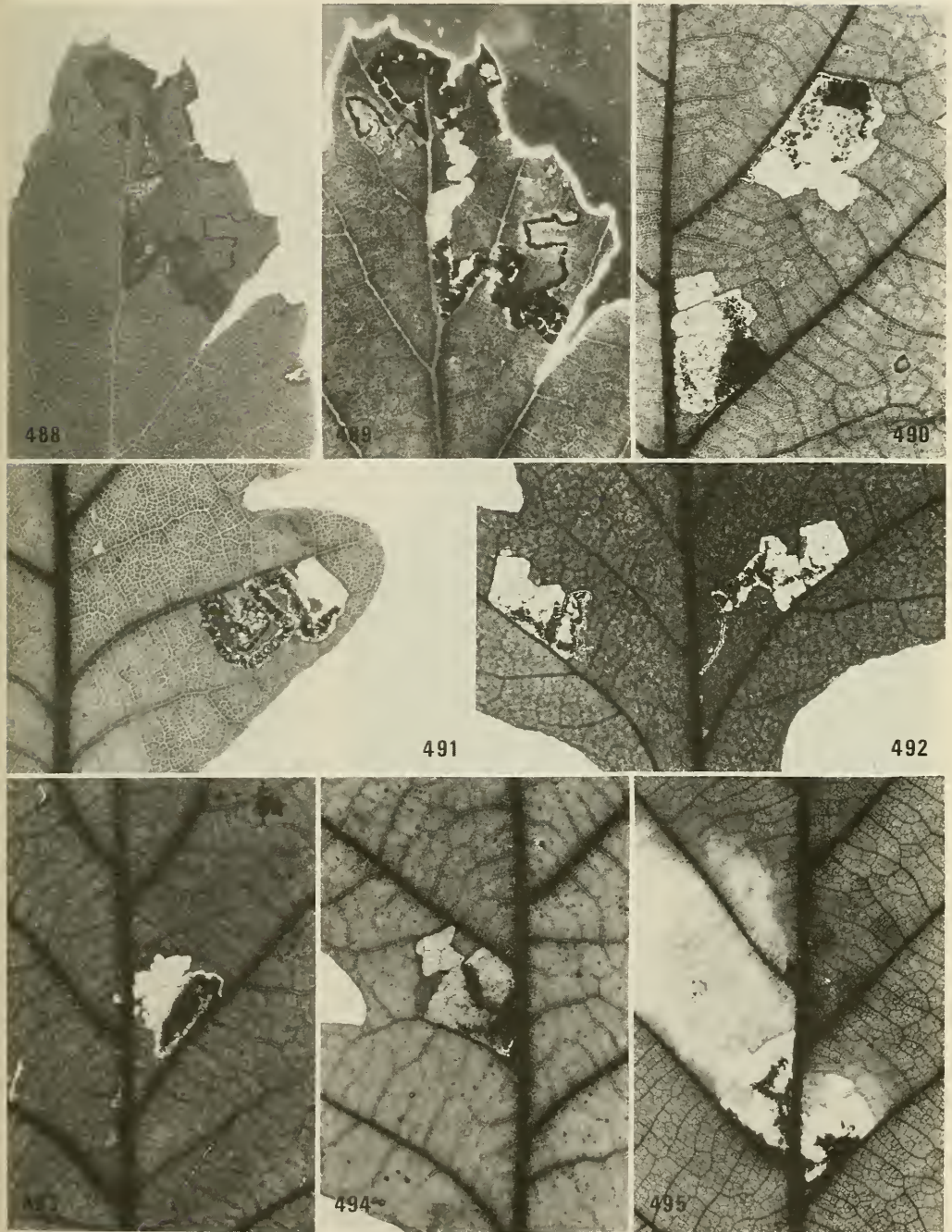

Figs. 488—495. Mines of *Ectoedemia* on leaves of *Quercus* spp. 488, 489, *E. ilicis* on *Q. suber*, Spain, Sierra Blanca; 490, *E. albifasciella* on *Q. petraea*, West Germany, Wiesbaum; 491, *E. nigrosarsella* on *Q. pubescens*, Austria, Gumpoldskirchen; 492, *E. ceris* on *Q. ceris*, Austria, Hof am Leithagebirge; 493, *E. pubescivora* on *Q. pubescens*, Italy, Picinisco; 494, *E. subbimaculella* on *Q. petraea*, Yugoslavia, Bihac; 495, *E. heringi* on *Q. petraea*, Hungary, Törökbalint.



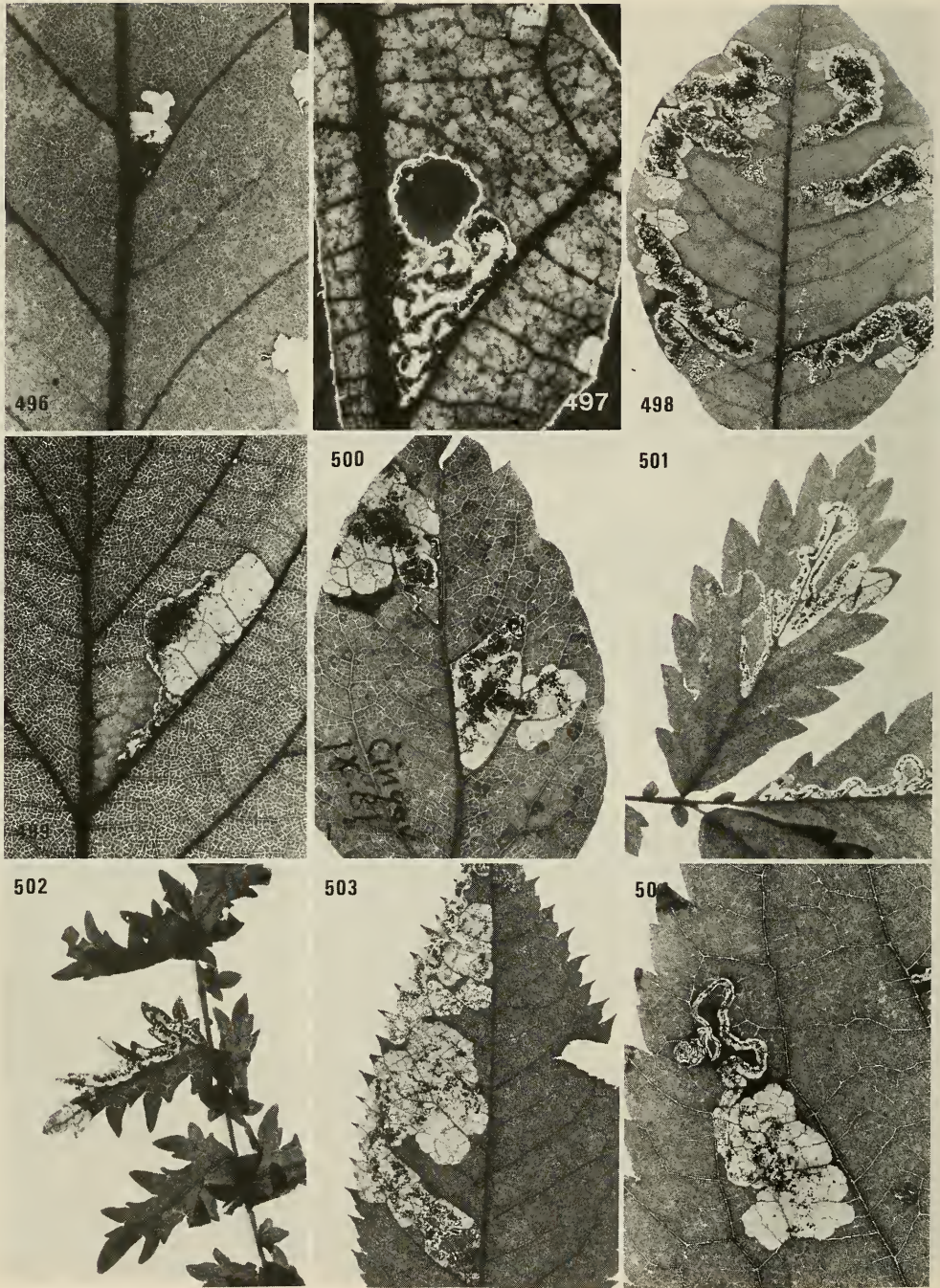

Figs. 496—504. Mines of *Ectoedemia*. 496, *E. liechtensteini* on *Quercus cerris*, Yugoslavia, Han Knežica; 497, *E. phyllotomella* on *Q. cerris*, Italy, Ferrania; 498, *E. terebinthivora* on *Pistacia terebinthus*, Greece, Dhelfoi; 499, *E. erythrogenella* on *Rubus ulmifolius*, Yugoslavia, Piran; 500, *E. spiraeae* on *Spiraea media*, Czechoslovakia, Čingov; 501, *E. agrimoniae* on *Agrimonia eupatoria*, Austria, Hundsheimer Berg; 502, *E. hexapetalae* on *Filipendula vulgaris*, Austria, Gramatneusiedl; 503, *E. angulifasciella* on *Rosa canina*, Netherlands, Ootmarsum; 504, *E. atricollis* on *Prunus avium*, Austria, Hof am Leithagebirge.



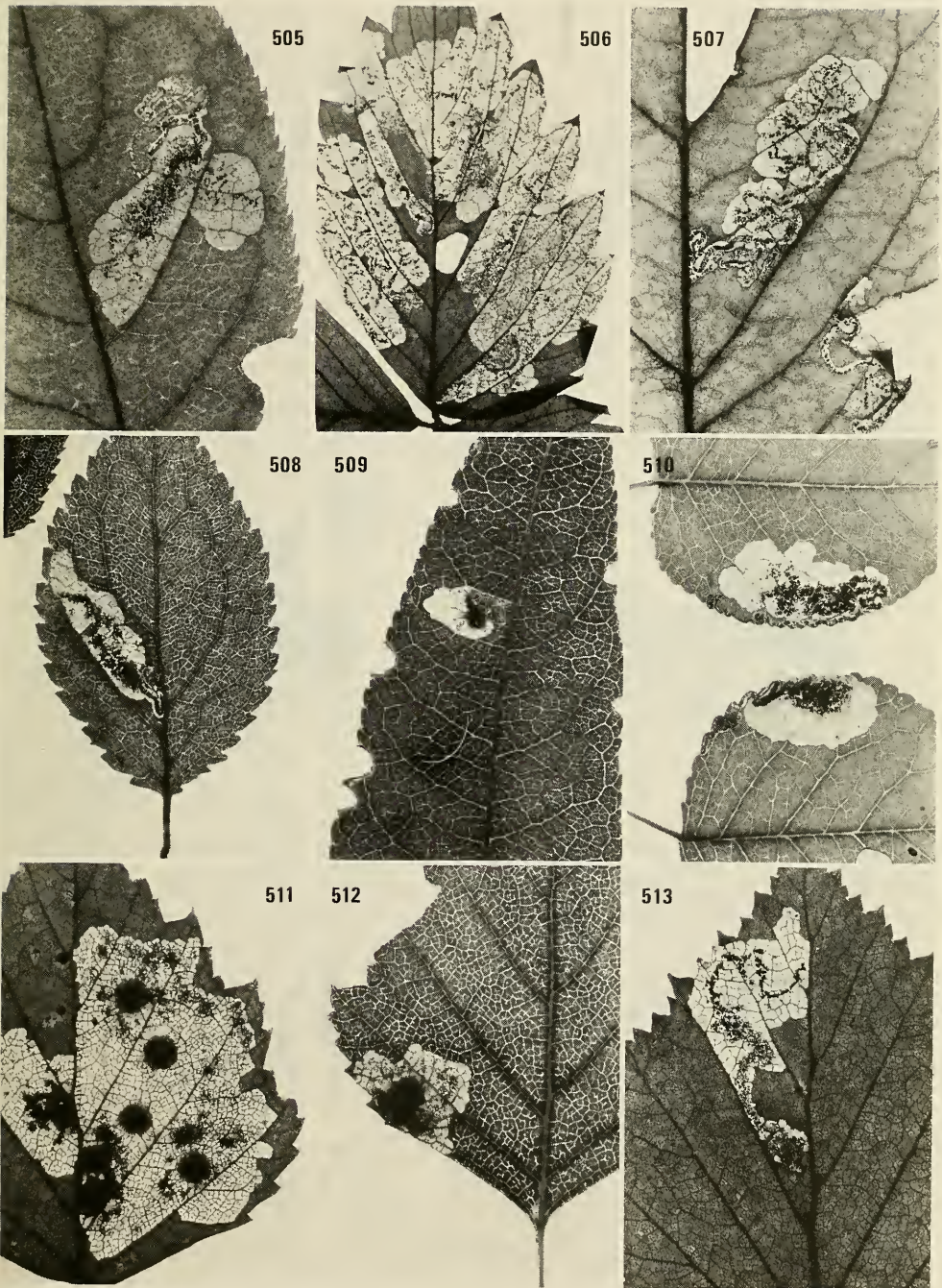

Figs. 505—513. Mines of *Ectoedemia*. 505, *E. atricollis* on *Staphylea pinnata*, Austria, Hundsheimer Berg; 506, *E. arcuatella* on *Fragaria vesca*, Austria, Völkermarkt; 507, *E. rubivora* on *Rubus saxatilis*, Italy, Trento; 508, *E. spinosella* on *Prunus spinosa*, Netherlands, Gulpen; 509, *E. spinosella* on *Prunus dulcis*, Greece, Arákhova; 510, *E. mahalebella* on *Prunus mahaleb*, Yugoslavia, Selce; 511, *E. occultella* on *Betula pubescens*, Italy, Trento; 512, *E. occultella* on *B. pendula*, Austria, Nassfeld Pass; 513, *E. minimella* on *B. pubescens*, Norway, Rennebu.

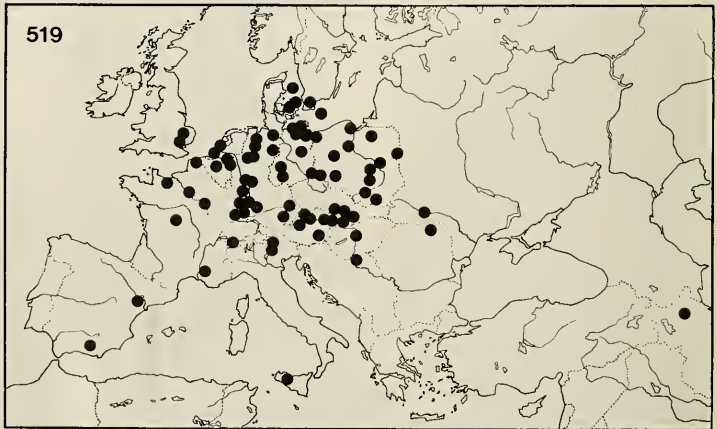
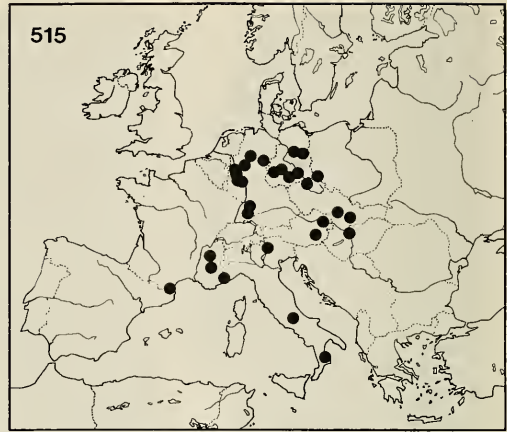
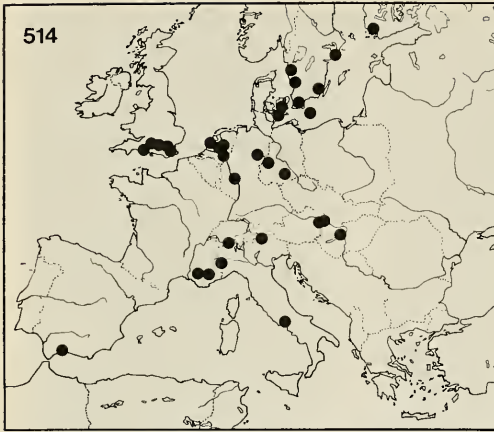

Figs. 514—519. Distribution maps of *Ectoedemia* spp. 514, *E. atrifrontella*; 515, *E. liebwerdella*; 516, *E. longicaudella*; 517, *E. hispanica* (rectangles) and *E. amani* (dots); 518, *E. hannoverella*; 519, *E. turbidella*.



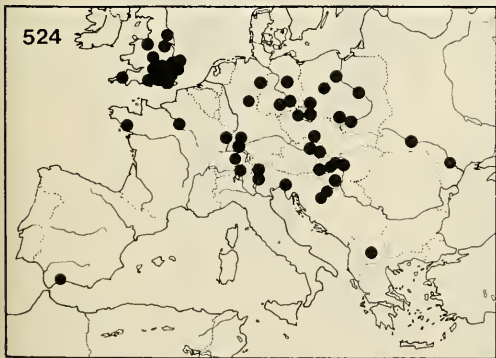
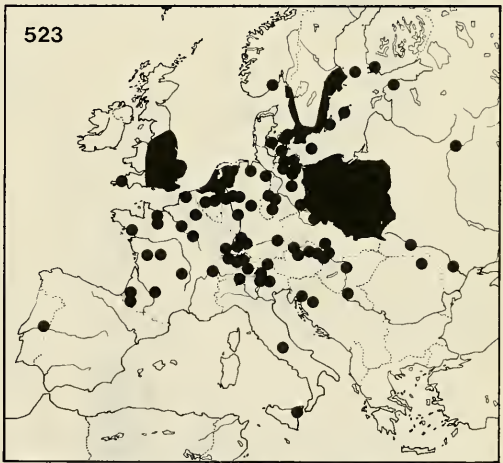
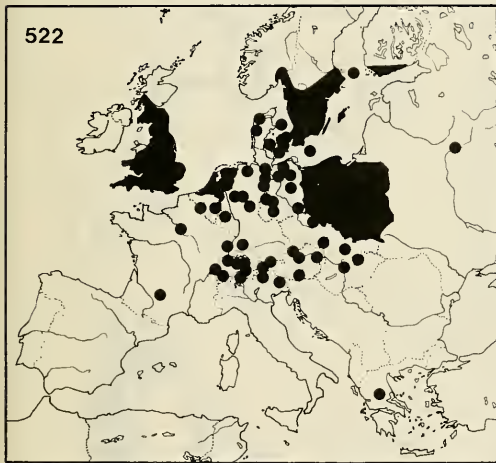
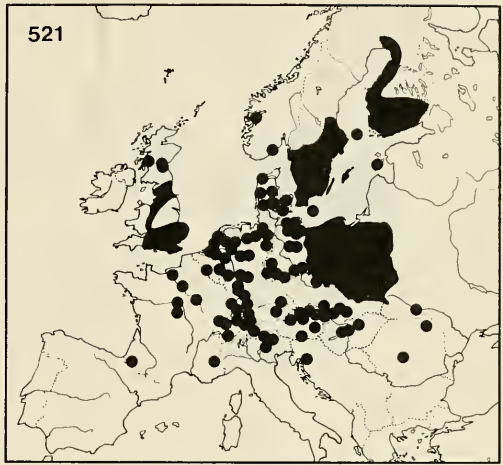
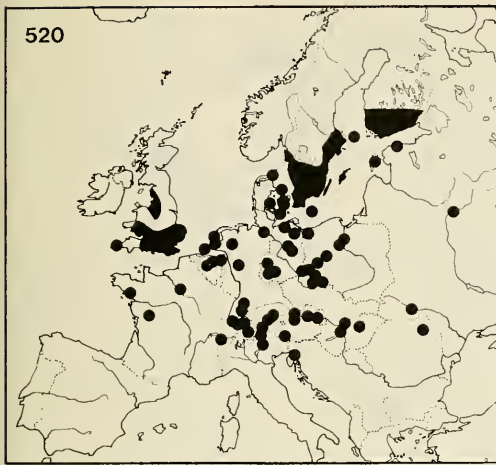

Figs. 520—525. Distribution maps of *Ectoedemia* spp. 520, *E. intimella*; 521, *E. argyropeza*; 522, *E. albifasciella*; 523, *E. subbimaculella*; 524, *E. heringi*; 525, *E. liechtensteini* (dots) and *E. phyllotomella* (triangles).

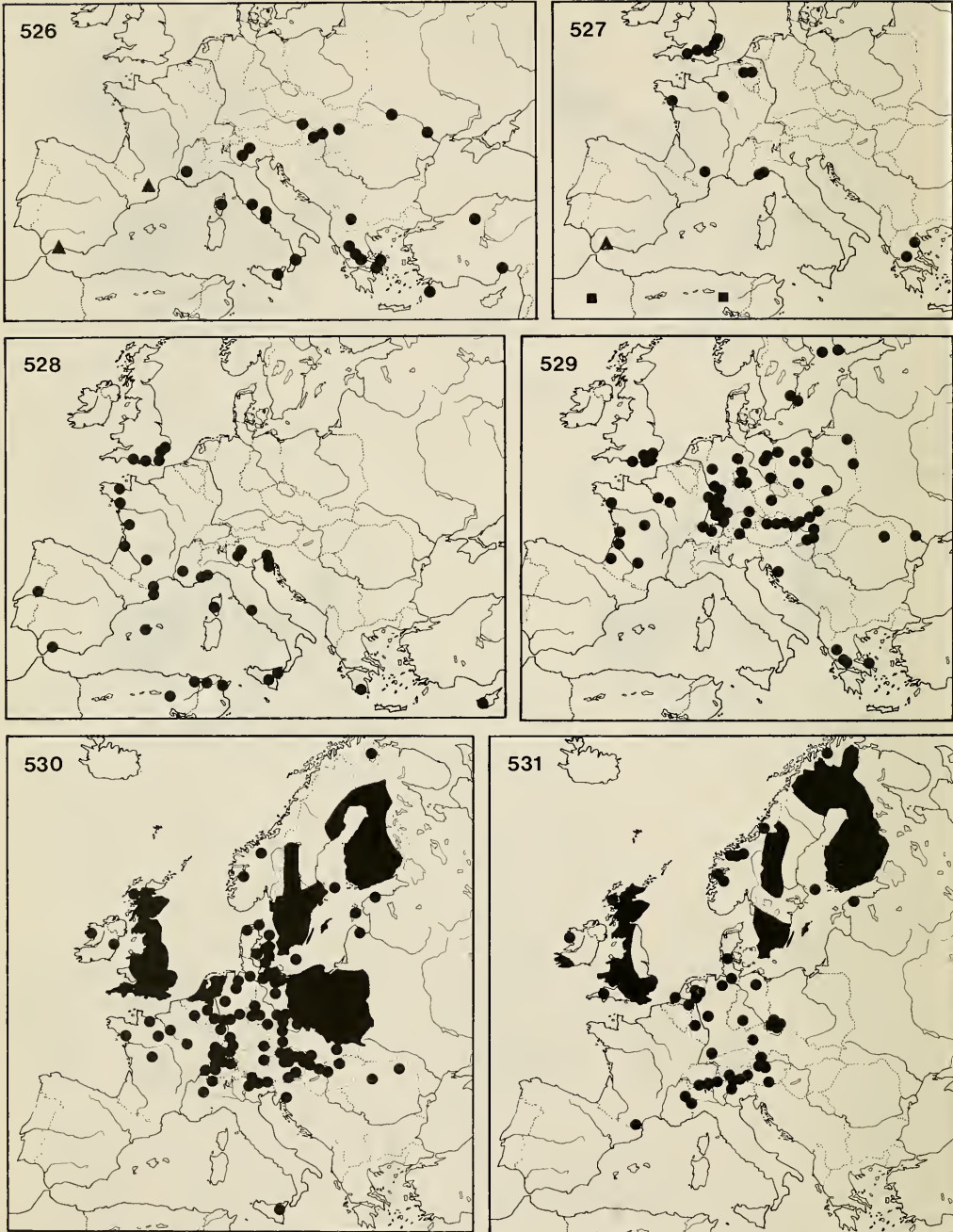

Figs. 526—531. Distribution maps of *Ectoedemia* spp. 526, *E. caradjai* (dots) and *E. andalusiae* (triangles); 527, *E. quinquella* (dots), *E. algeriensis* and ♂ cf. *algeriensis* (rectangles) and *E. leucothorax* and ♀ cf. *algeriensis* (triangle); 528, *E. erythrognella*; 529, *E. agrimoniae*; 530, *E. occultella*; 531, *E. minimella*.

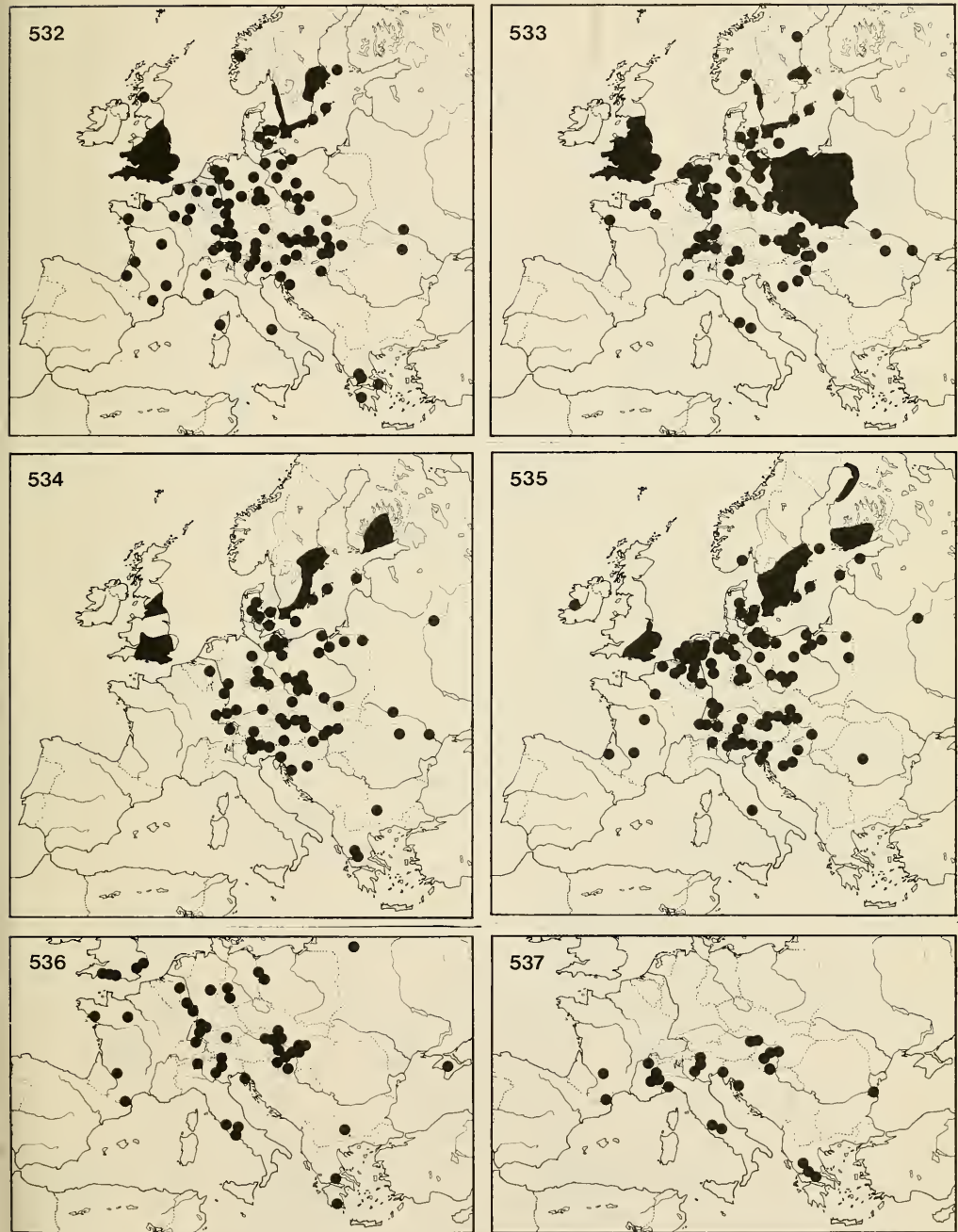

Figs. 532—537. Distribution maps of *Ectoedemia* ssp. 532, *E. angulifasciella*; 533, *E. atricollis*; 534, *E. arcuatella*; 535, *E. rubivora*; 536, *E. spinosella*; 537, *E. mahalebella*.



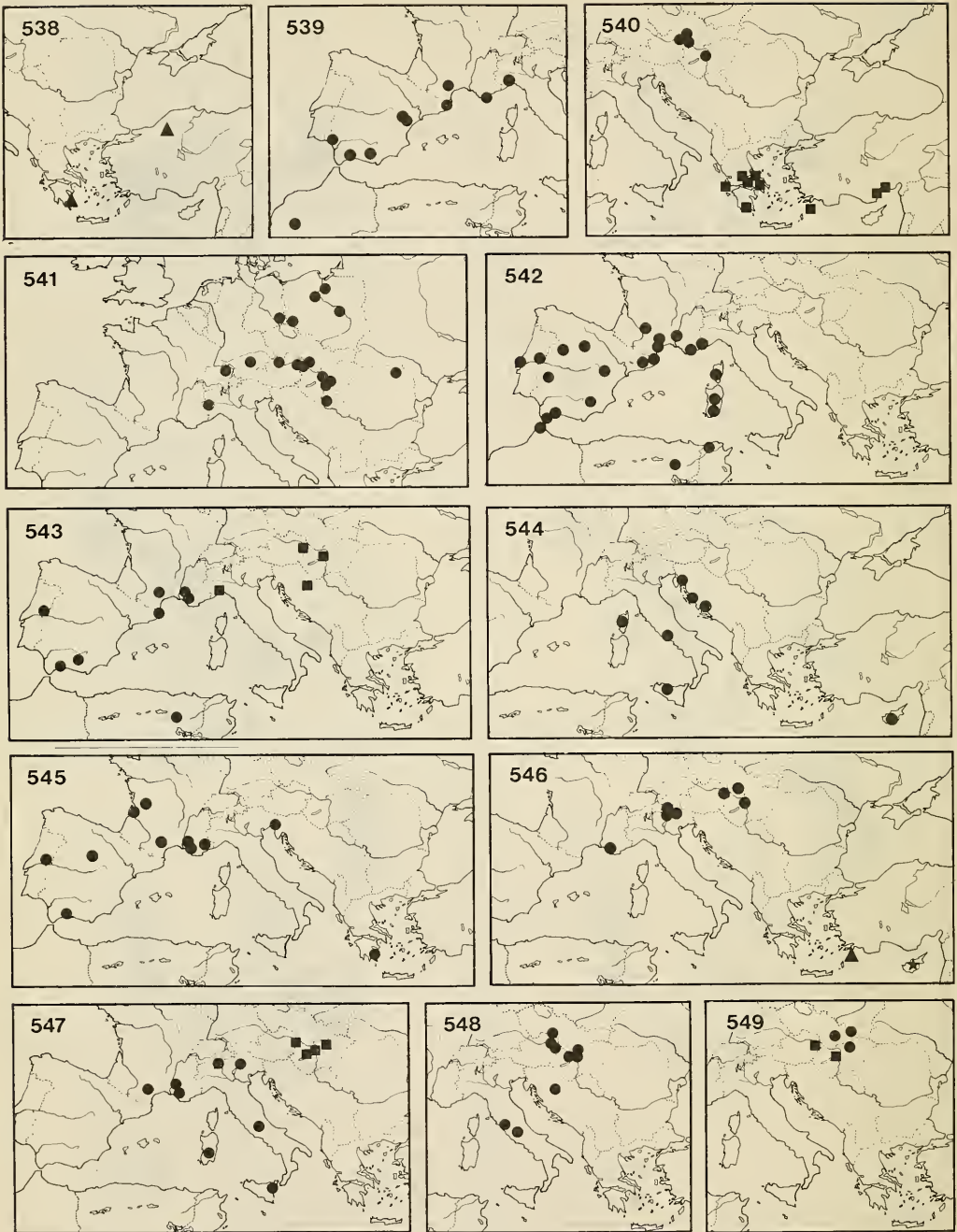

Figs. 538—549. Distribution maps of *Ectoedemia* spp. 538, *E. monemvasiae*; 539, *E. liguricella*; 540, *E. preiseckeri* (dots) and *E. terebinthivora* (rectangles); 541, *E. klimeschi*; 542, *E. suberis*; 543, *E. gilvipennella* (rectangles) and *E. ilicis* (dots); 544, *E. heringella*; 545, *E. baraldi*; 546, *E. nigrosarsella* (dots), *E. aegilopidella* (triangle) and *E. alnifoliae* (star); 547, *E. pubescivora* (dots) and *E. contorta* (rectangles); 548, *E. cerris*; 549, *E. spiraeae* (dots) and *E. hexapetalae* (rectangles).







# TIJDSCHRIFT VOOR ENTOMOLOGIE

UITGEGEVEN DOOR

DE NEDERLANDSE ENTOMOLOGISCHE VERENIGING



## INHOUD

M. R. DE JONG. — Taxonomy and biogeography of Oriental Prasiini I: The genus *Prasia* Stål, 1863 (Homoptera, Tibiciniidae), pp. 165—191. figs. 1—91.



# TAXONOMY AND BIOGEOGRAPHY OF ORIENTAL PRASIINI 1: THE GENUS *PRASIA* STÅL, 1863 (HOMOPTERA, TIBICINIDAE)

by

M. R. DE JONG

*Institute of Taxonomic Zoology (Zoölogisch Museum), University of Amsterdam, Amsterdam, The Netherlands*

## ABSTRACT

The taxonomic concept of the genus *Prasia* is re-established on account of characters found in the male genitalia. The genus now consists of a monophyletic group of seven species: *P. faticina* Stål, 1863, *P. princeps* Distant, 1888, *P. breddini* n. sp., *P. sarasinorum* n. sp., *P. senilirata* n. sp. and *P. tuberculata* n. sp., all from Sulawesi, and *P. nigropercula* n. sp. from the nearby Muna Island. All species are (re)described and structures of taxonomic importance as well as the whole insects are depicted. A key to the males is presented. Study of (type-)material established the new synonymy of *P. culta* Distant, 1898, with *P. faticina*. *P. hariola* Stål, 1863, and *P. tincta* Distant, 1909, are transferred to other genera of the Prasiini.

## INTRODUCTION

The present study of the genus *Prasia* Stål, 1863, is a further contribution to a revision of the tribe Prasiini, started by De Jong & Duffels (1981) and De Jong (1982). Preliminary phylogenetic investigations plead in favour of common ancestry of four Oriental genera belonging to this tribe: *Prasia*, *Lembeja* Distant, 1892, *Arfaka* Distant, 1905, and *Jacatra* Distant, 1905. It is questionable whether the other genera placed in the Prasiini, viz. *Lacetas* Karsch, 1890, *Iruana* Distant, 1905 (both from Africa), and *Sapan-tanga* Distant, 1905 (from South America), do form a monophyletic group together with the four above mentioned genera. Taxonomic and phylogenetic studies of the Oriental genera are to provide a basis for a reconstruction of their distributional history.

The tribe Prasiini is presently distributed, as far as its Oriental members are concerned, in the Philippines, Sanghir, Sulawesi, Java, Lesser Sunda Islands, Misoöl, New Guinea and Northern Queensland (Australia), and therefore considered an excellent group to test Duffels' idea about the role of Tertiary island arcs in the development of the Cicadoidea fauna of Sulawesi, Moluccas, New Guinea and West Pacific. Duffels (1983a, b) indicated two routes of dispersal: in southern direction from the Philippines to Sulawesi, and in eastern direction from the Philippines to the Moluccas, New Guinea and the

South-West Pacific. The eastern route itself is to be divided in two subroutes: the Inner- and Outer Melanesian Arcs (for a more detailed description the reader is referred to Holloway (1979) and Duffels (1983a)). Study of the Prasiini will extend the area dealt with by Duffels to the Lesser Sunda Islands and Java, while material obtained recently contains representatives from northern Borneo and Sumatera.

The present study of the genus *Prasia* reveals that this very homogenous genus is confined to Sulawesi and the nearby Muna Island.

## HISTORY OF THE GENUS

The genus *Prasia* Stål, 1863, was described to accommodate two new species, *Prasia faticina* Stål, 1863, and *Prasia hariola* Stål, 1863. However, Stål (1862) had already referred *Cephaloxys foliata* Walker, 1858, to *Prasia*, thus creating *Prasia* by indication (International Code of Zoological Nomenclature, 1985, Chapter iv, Article 12b, 5). For various reasons<sup>1)</sup> I favour suppression of this indication. A request to the International Commission is in preparation.

<sup>1)</sup> According to the Rules (International Code of Zoological Nomenclature, 1985, Chapter iv, Article 12b 5), *Cephaloxys foliata* Walker, 1858, is the type-species by monotypy of *Prasia* Stål, 1862. Since *P. foliata* is currently placed in *Lembeja* Distant, 1892 (type-species *L. maculosa* (Distant, 1883)) by Distant

(continued overleaf)



Pending the Commission's decision I adhere to common usage (e.g. Distant, 1905) in using *Prasia faticina* as the type species of *Prasia*.

Subsequently Stål (1870) added *P. fatiloqua* Stål, 1870. In later publications *P. princeps* Distant, 1888, *P. culta* Distant, 1898, *P. tincta* Distant, 1909, and *P. vitticollis* Ashton, 1912, were described. The last mentioned species was transferred recently (De Jong, 1982) to the genus *Lembeja*, on account of similarities in the opercula, male genitalia and wing-venation with some New Guinean representatives of this genus.

Furthermore some non-Prasiini have been (erroneously) attributed to the genus *Prasia*.

Metcalf (1963) listed the following species under *Prasia*: *P. culta*, *P. faticina*, *P. hariola*, *P. princeps* and *P. tincta*. *P. fatiloqua* and *P. foliata* were listed as members of *Lembeja*, following Horvath (1913) and Myers (1928, 1929) for *fatiloqua* and Distant (1906) for *foliata*.

My study of the genera *Prasia* and *Lembeja* revealed that generic characters for *Lembeja*, as defined in the rudimentary vein (Distant, 1892) and the fusion of the  $Cu_2$  and  $A_1$  veins in the wing (Karsch, 1890b; Jacobi, 1903; Schmidt, 1925), were unsatisfactory. Breddin (1901) even ignored the existence of *Lembeja* and attributed all species studied by him and known at the time to *Prasia*. On the other hand he created the new genus *Drepanopsaltria* Breddin, 1901, for two *Prasia* species, viz. *P. culta* and *P. princeps*. Distant (1905) separated *Prasia* and *Lembeja* on account of characters in the tegmina. In *Prasia* the 3rd ulnar area is much shorter than the 1st, whilst in *Lembeja* they are more or less of equal length; the 4th ulnar area is much shorter than the radial area in *Prasia*, whilst in *Lembeja* the 4th is about as long or even just a little longer than the radial one. Apart from some borderline cases this is more or less correct, but one must bear in mind, that these characters are only valid when comparing *Prasia* with *Lembeja*.

Here, a new concept for *Prasia* will be presented, readily distinguishing *Prasia* from the other genera of the Oriental Prasiini.

(1906) and other authors, all species of *Lembeja* should be transferred to *Prasia*, so that *Lembeja* becomes a junior subjective synonym of *Prasia*.

All authors have taken *P. faticina* as the type-species of *Prasia*. A valid name for *Prasia* in its common usage, i.e. the concept based on *P. faticina*, could then be *Drepanopsaltria* Breddin, 1901 (type-species *Prasia culta* Distant, 1898, a junior synonym of *Prasia faticina* Stål, 1863). The name *Drepanopsaltria* has not been used as a valid name after 1905.

## A NEW CONCEPT FOR THE GENUS *PRASIA*

### Monophyly of the genus *Prasia*

In my opinion *P. faticina* (with *P. culta* as a new synonym), *P. princeps*, and five new species, viz. *P. breddini* n. sp., *P. nigropercula* n. sp., *P. sarasinorum* n. sp., *P. senilirata* n. sp. and *P. tuberculata* n. sp., form a monophyletic group.

At first sight the *Prasia* species can be separated from all other Oriental Prasiini by the straight margins of the pronotum collar (in lateral view), which are downgraded in the other genera. However, not much phylogenetic value can be attributed to this feature, since it is found in several other groups of Cicadoidea.

The monophyly of *Prasia* in its new concept finds its justification in the supposed apomorphy found in the degrading lateral margins of the pygofer between the lateral lobes and the caudal dorsal beak (fig. 8).

### Consequences of the new genus concept for remaining *Prasia* species

Beside the species included now in *Prasia*, Metcalf (1963) listed two other species: *P. hariola* and *P. tincta*. As a consequence of the new concept for *Prasia* these species are transferred to other genera.

*P. hariola*, of which recently a small, but very fine, series from Misoöl was discovered in the Vienna Museum, does not show the shape of the pygofer and the uplifted pronotum collar that characterize *Prasia* within the Oriental Prasiini. Moreover, *P. hariola* shows a structure of the male genitalia and a venation of tegmina and wings that characterize the previously monotypic genus *Arfaka*. This is ample evidence that *P. hariola* is to be considered a member of *Arfaka* (together with *A. fulva* (Walker, 1868)). *A. hariola* is described from the island of Misoöl and also known from New Guinea (Vogelkop) (Distant, 1892).

*P. tincta* is transferred to the genus *Lembeja*, as it shows affinities with one of the four species-groups of *Lembeja*, the so-called *L. fatiloqua* group. This group is characterized by the longitudinally medially dented abdominal tergite 1 in the males (see also De Jong, 1982). *L. tincta* has been described from Bua-Kraeng and is now also known from Lompobattang (both localities in South Sulawesi).

### MATERIAL AND METHODS

The material examined for this study belongs

to 13 institutions, which are listed as depositories. All type-material has been studied. Some museums have been visited in order to look for additional material.

For tracing the localities I have used the Atlas van Tropisch Nederland (1938), the Times Atlas of the world (1973) and personal information from Dr. J. P. Duffels, Amsterdam. The distributions are presented on fig. 7.

Terminology follows Duffels (1977, 1983a) with a few new morphological terms and modifications introduced, which will be explained in figs. 1—6, 8, 9, 11.

The methods of Duffels (1977) are used for the examination of the male genitalia.

Measurements were, apart from using a marking gauge with nonius, taken through a stereoscopic microscope with a specially designed ocular.

#### DEPOSITORIES

The abbreviations given below have been used in the lists of material and throughout the text.

AMS	Australian Museum, Sydney
BIN	Koninklijk Belgisch Instituut voor Natuurwetenschappen, Brussel
BM	British Museum (Natural History), London
CNMW	Naturhistorisches Museum, Wien
DEI	Deutsches Entomologisches Institut, Eberswalde
MHNG	Muséum d'Histoire Naturelle, Genève
MNP	Muséum National d'Histoire Naturelle, Paris
MSNG	Museo Civico di Storia Naturale "G. Doria", Genova
MZB	Museum Zoologicum Bogoriense, Bogor
NRS	Naturhistoriska Riksmuseet, Stockholm
SMD	Staatliches Museum für Tierkunde, Dresden
TMB	Természettudományi Múzeum, Budapest
ZMA	Instituut voor Taxonomische Zoölogie, Zoölogisch Museum Amsterdam.

#### ACKNOWLEDGEMENTS

I am very obliged to Dr. J. P. Duffels and Dr. P. Oosterbroek for their critical reading of the manuscript.

The help and hospitality of Dr. W. J. Knight,

Mr. M. D. Webb and Mr. P. S. Broomfield (BM), Mr. R. Detry (BIN), Dr. A. Kaltenbach c.s. (CNMW), Dr. B. Hauser (MHNG), Dr. M. Boulard (MNP), Dr. R. Poggi (MSNG) and Dr. P. Lindskog (NRS), met with during my stay at their institutions is gratefully acknowledged. I feel also obliged to these persons for the loan of material under their care. The remaining material was gratefully received from Dr. C. N. Smithers (AMS); Prof. Dr. H. J. Müller, Dr. G. Petersen and Dr. A. Täger (DEI); Dr. S. Adisoemarto (MZB); Dr. R. Emmrich (SMD); Dr. Z. Kaszab (TMB).

I am indebted to Mr. G. Verlaan and Mr. J. Zaagman for technical assistance, to Mr. L. Van der Laan for the photographs, to Miss A. Stoel for typing the manuscript and to Dr. W. N. Ellis for help with nomenclatural problems.

The investigations were supported by the Foundation for Fundamental Biological Research (BION), which is subsidized by the Netherlands Organization for the Advancement of Pure Research (ZWO).

The participation of Dr. J. P. Duffels in the "Project Wallace" Expedition was supported by the Netherlands Foundation for the Advancement of Tropical Research (WOTRO).

#### TAXONOMY

##### *Prasia* Stål, 1863

*Prasia* Stål, 1862: 483 (num. nud.); Stål, 1863: 574 (original description); Walker, 1868: 94; Stål, 1870: 718; Distant, 1892: 103, 145; Breddin, 1901: 113, 153, 183, 200, 201; Jacobi, 1903: 12, 13; Distant, 1905: 275, 278 (equals *Drepanopsaltria* Bredd.); Distant, 1906: 182, 183 (equals *Drepanopsaltria* Bredd.); Ashton, 1912: 221; Kato, 1932: 14, 30, 188, 189; Kato, 1956: 23, 70, 77, 78, 80; Metcalf, 1963: 423; Boulard, 1975: 315; Duffels, 1977: 205; Holloway, 1979: 235; De Jong & Duffels, 1981: 53, 61; De Jong, 1982: 182, 183; Duffels, 1983b: 492; Duffels & Van der Laan, 1985: 298.

*Drepanopsaltria*; Breddin, 1901: 113, 183, 200, 201; Jacobi, 1903: 12; Metcalf, 1963: 425 (in synonymy of *Prasia* Stål).

For a more complete list, refer to Metcalf (1963).

Type-species: *Prasia faticina* Stål, designated by Distant, 1905: 278.

Genital characters are given only for the males as there were too few females available to justify damaging specimens by dissection. When

more material will be available the study of the female specimens will be continued.

#### Diagnosis.

Postclypeus obconically protruding in dorsal view. Antennal segment 1 extending clearly from under supra-antennal plate. Head 1.49—2.07 × as long as width of vertex between eyes. Width of head 2.26—2.76 × width of vertex between eyes. Head and pronotum together somewhat longer than meso- and metanotum together. Pronotum collar nearly twice as broad

as width of head including eyes, not bent ventrally, but forming a straight line along the lateral margins of the pronotum to the head (fig. 5).

Fore femora with three thorns, basal cylindrical one with a dark brown apex; two apical thorns laterally compressed, middle thorn being almost as long as basal one, most apical one very small (fig. 3).

Male opercula sickle-shaped and reaching 2nd sternite of abdomen. Female opercula small and more or less rounded.

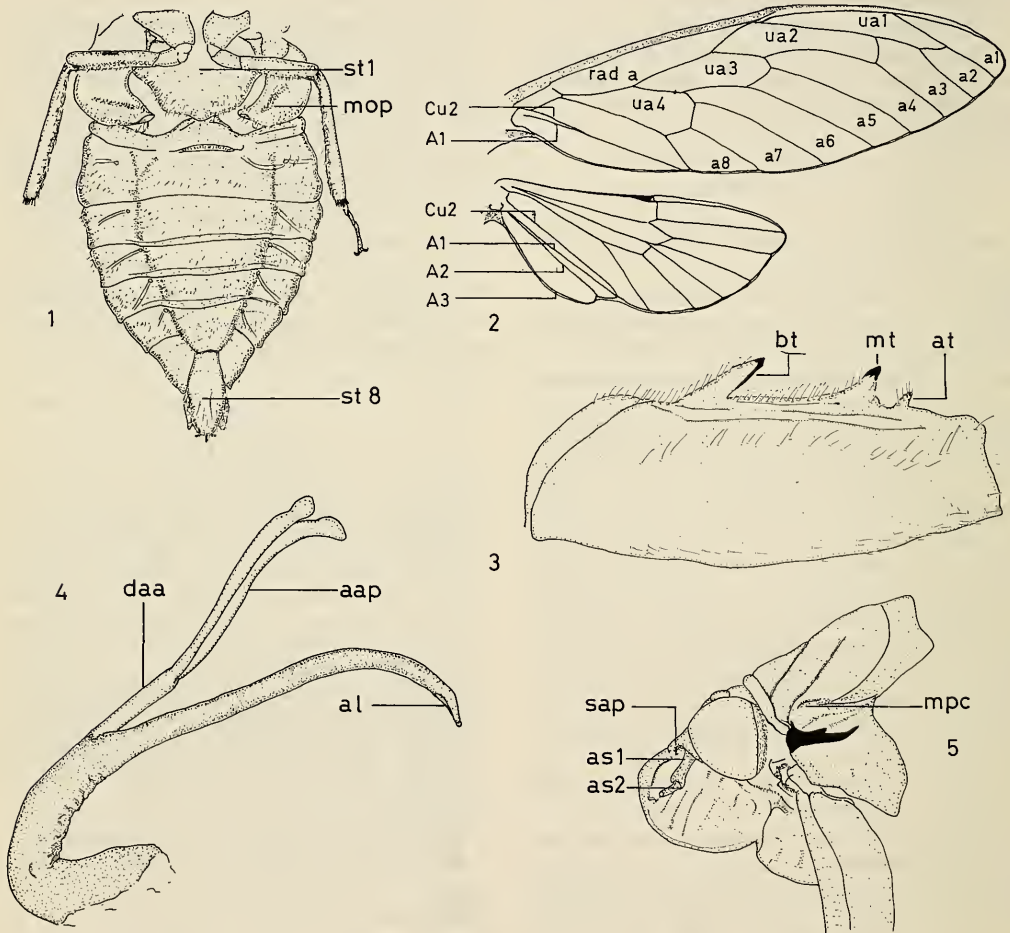

Figs. 1—5. Figures of *Prasia*: 1, male abdomen in ventral view, *Prasia princeps*; 2, right tegmen and wing, *P. princeps*; 3, male femur in lateral view, *P. princeps*; 4, aedeagus in lateral view (after treatment with 10% KOH), *P. princeps*; 5, head and pronotum in lateral view, *P. princeps*. (a 1—8 = 1st—8th apical area; A 1—3 = 1st—3rd anal vein; aap = aedeagal appendage process; as 1—2 = antennal segment 1—2; at = apical thorn; bt = basal thorn; Cu 2 = 2nd cubital vein; daa = dorsal aedeagal appendage; mop = male operculum; mpc = margin pronotum collar; mt = middle thorn; rad a = radial area; sap = supra antennal plate; st 1,8 = 1st, 8th sternite; ua 1—4 = 1st—4th ulnar area.)





Fig. 6. Tymbal, lateral view, *P. nigropercula* (lr = long ridge, sr = short ridge, tr = tymbal ridge).

Tegmina of males pale-hyaline, of females subhyaline. Wings pale-hyaline. Tegmina with fairly long apical areas, 3rd apical area less than  $0.78 \times$  the 4th one, 3rd ulnar area less than  $0.87 \times$  the 1st one, 4th ulnar area less than  $0.77 \times$  radial area.  $A_1$  and  $Cu_2$  veins fused up to the tegmen border.

Anal field of wing enclosed by a fusion of the  $Cu_2$  and  $A_1$  veins or not. Anal lobe (area between  $A_2$  and  $A_3$ ) apically fairly narrow (fig. 2).

Male abdomen inflated, broadly raised medially along its whole length (tergite 2—8), but not carinate; ventrally bulged out. Tymbal ridges on tergite 2 distinct (fig. 6). Abdominal sternite 1 in males very large and swollen (fig. 1); its distal margin convex or slightly concave. Male sternite 8 apically slightly to strongly pointed.

Tymbals with 6—9 (in *P. princeps* sometimes 10) long ridges alternating with usually the same number of short ridges.

Female abdomen distally more or less clubshaped, since greatest width of segment 9 is broader than width of hind margin of segment 8. Ovipositor sheath just or not reaching beyond caudal dorsal beak.

Lateral lobes of male pygofer fairly short, swollen and acutely pointed, not extending beyond anal valves. Caudal dorsal beak laterally compressed, and therefore very slender and long. Hind part of lateral margin between caudal dorsal beak and each of lateral lobes degrading as in fig. 8. Claspers more or less swollen

and mostly elongate apically. Median uncus part above aedeagus small. Aedeagus slender, with two rounded, sometimes slightly dentate, lobes. Aedeagus with a dorsal appendage, splitting in two slender, apically pointed or rounded, processes, weakly sclerotized (fig. 4). Adjustment of aedeagus usually halfway the length of pygofer.

#### KEY TO THE MALES OF *PRASIA*

1. Operculum nearly black, contrasting with pale underside of the thorax. *Muna* . . . . .  
     . . . . . *nigropercula* (p. 180)
- Operculum concolorous with the (mostly pale) underside of the thorax . . . . . 2
2. Medium-sized to large species (body length: 24.6—29.7 mm). Body colour green to greenish-olivaceous.  $Cu_2$  and  $A_1$  veins in the wing may be fused. North and Central Sulawesi . . . . . 3
- Small to medium-sized species (body length: 19.6—23.8 mm). Body colour brown, pale-brown or orange-brown.  $Cu_2$  and  $A_1$  veins never fused. Central, East and South Sulawesi . . . . . 4
3. Genitalia as in figs. 60—68.  $Cu_2$  and  $A_1$  veins usually fused. 9 (sometimes 8 or 10) long ridges alternating with usually the same number of short ridges. North Sulawesi . . . . . *princeps* (p. 182)
- Genitalia as in figs. 76—81.  $Cu_2$  and  $A_1$  not fused. 6 long ridges alternating with the same number of short ridges. Central Sulawesi . . . . . *senilirata* (p. 186)
4. Central fascia on the pronotum usually concolorous with it. Central and East Sulawesi . . . . . 5
- Central fascia usually dark-brown coloured, or traces of such a coloration present. Central and South Sulawesi . . . . . 6
5. Operculum rounded apically (fig. 39). Central Sulawesi . . . . . *sarasinorum* (p. 176)
- Operculum pointed apically (fig. 14). East Sulawesi . . . . . *tuberculata* (p. 178)
6. Genitalia as in figs. 8—13. South Sulawesi . . . . . *faticana* (p. 170)
- Genitalia as in figs. 21—26. Central Sulawesi . . . . . *breddini* (p. 174)

The females are not included in the key, since these are known with certainty of two species only. The females *P. princeps* are generally green to greenish-olivaceous (sometimes with a brownish tinge), whilst those of *P. faticana* are usually orange-brownish with olivaceous

tings. Females of *P. princeps* (25.9—30.2 mm) are usually larger than those of *P. faticina* (24.6—26.2 mm). Third ulnar area of *P. faticina* females often, but not always, shaped as in fig. 20, of *P. princeps* females usually as in fig. 2, some females have a 3rd ulnar area of intermediate shape (fig. 70).

***Prasia faticina* Stål, 1863**  
(figs. 7—20, 86, 87)

*Prasia faticina* Stål, 1863: 574 Stål, 1870: 94; Distant, 1888: 325; Distant, 1892: xiv, 145 (partim: only Makassar), pl. 7 figs. 14, 14a, b; 146; Jacobi, 1903: 12; Distant, 1905: 278; Distant, 1906: 183; Kato, 1932: 189; Metcalf, 1963: 424.

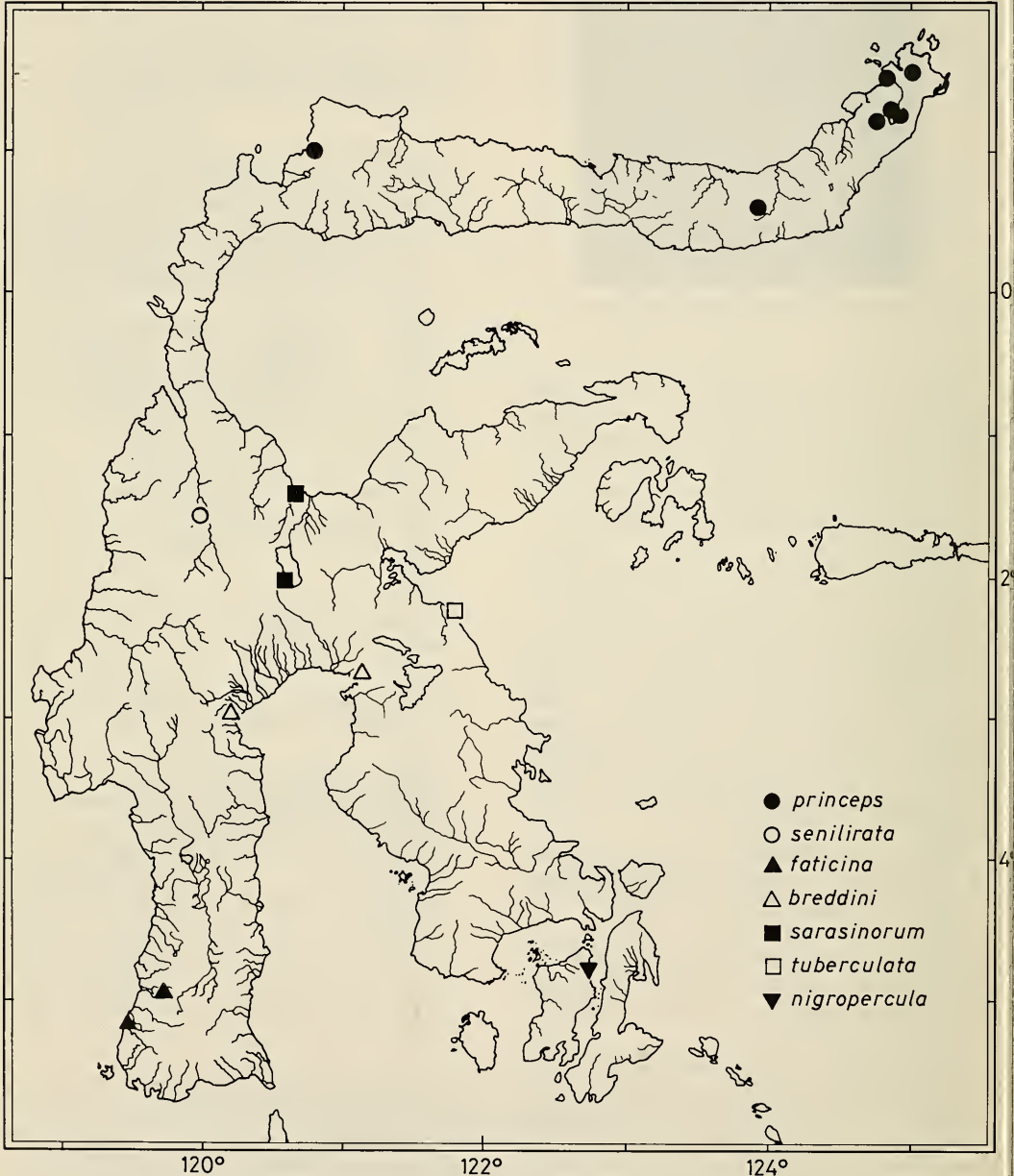

Fig. 7. Distributions of the species of *Prasia*, *P. breddini*, *P. faticina*, *P. nigropercula*, *P. princeps*, *P. sarasinorum*, *P. senilirata* and *P. tuberculata*.

*Prasia culta* Distant, 1898: 97; Distant, 1905: 279 (equals *Drepanopsaltria* (*Lembeja*) *culta* Bredd.); Distant, 1906: 184 (ditto); Kato, 1932: 32, text-fig. 37c, 189, pl. 26, fig. 12; Metcalf, 1963: 424 **Syn. nov.**

*Drepanopsaltria culta*; Breddin, 1901: 28, 113; Jacobi, 1903:10.

The following references to *Prasia faticina* were found to relate to other species: Distant, 1892: 145 (partim: specimen from Kandari is unidentified); Breddin, 1901: 112, 113, 153, pl. 1 fig. 17 (= *Lembeja maculosa* (Distant, 1883)).

The following reference to *Prasia culta* was found to relate to *P. princeps*: Lallemand, 1931: 78.

#### Lectotype designation.

*Prasia culta* was described after two male specimens from Patunuang, both stored in the British Museum (Nat. Hist.). One, bearing the following labels, is designated lectotype: "*culta*/Dist." (handwritten, black); "S. Celebes/ Patunuang/ Jan. 1896/ H. Fruhstorfer" (print, black cadre); "Type" (round label, red edged, print); "SYN-/ TYPE" (round label, blue edged, print); "8" (print); "Distant Coll./ 1911—383" (print). Consequently, the other specimen with a syntype label is a paralectotype.

#### Synonymy.

Comparison of the female holotype of *P. faticina* and the female *P. culta* specimens inferred conspecificity, though the holotype of *P. faticina* is of an almost entire olivaceous colour. The original description of *P. faticina* by Stål (1863) gives as body colour: "Pallidissime subolivaceo-flavescens", which means that the body had a sort of yellowish colouring. This is an indication that the original coloration has changed. Furthermore, the female *culta*-specimens have a coloration that is much more alike the coloration given by Stål (1863).

#### Description.

Body of males dark-brown or light orange-brownish, dark coloured specimens with a light pronotum with a dark collar. Females orange-yellowish with olivaceous. Dark male specimens ventrally paler. Head and pronotum together 1.02—1.22 × as long as meso- and metanotum together. Female thorax and head together 0.83—0.94 × as long as abdomen; male 0.73—0.82 × as long. Greatest width of the

body at the height of pronotum collar or 3rd abdominal segment.

Head. — Dark or light in males, light in females. Light coloured males brown between the eyes with a middorsal stripe from margin of pronotum up to fissure between lateral ocelli. Eyes 0.63—0.8 × as wide as vertex width between eyes. Ocelli raised. Distance between lateral ocelli 1—1.45 × as long as distance between eye and lateral ocellus. Head 1.49—1.85 × as long as vertex width between eyes. Width of head 2.26—2.6 × as wide as width of vertex between eyes. Postclypeus in ventral view strongly laterally compressed, paler than dorsally. Transverse ridges concolorous, sometimes upper four ridges slightly darker coloured. Rostrum with a black apex reaching hind margin of intermediate coxae.

Thorax. — In dark male specimens pronotum collar, lateral margin of pronotum and central fascia chocolate-brown, in lighter specimens this coloration less conspicuous. Females with a dark coloured line on the lateral margin (not reaching the pronotum collar) only. Pronotum collar 1.77—2.02 × as wide as head including eyes. Mesonotum with four pale, irregularly speckled obconical areas, sometimes hardly or not discernable. Lateral parts of mesonotum and parts in front of cruciform elevation sometimes (especially in the females) olivaceous tinged. In dark coloured male specimens posterior part of cruciform elevation as well as metanotum chocolate-brown.

Legs. — Concolorous, except fore tibiae and tarsi, which are mostly dark-brown.

♂. Tegmina and wings. — Tegmina pale hyaline, extreme base vermilion-red. Costal membrane chocolate-brown, in lighter coloured males pale-brown. Venation brownish- or pale-ochraceous, basal area infuscated. Third ulnar area (sometimes shaped as in fig. 20) 0.65—0.83 × as long as 1st ulnar area; 4th ulnar area 0.64—0.74 × as long as radial area. Apical areas of the tegmen long, 4th, 5th, 7th longest; 3rd apical area 0.58—0.71 × as long as 4th one. Hardly any indication of a corial fold, nor of any remnant of a transverse vein extending from the 2nd ulnar area into the 3rd. Wings pale hyaline, colour of venation as in tegmina, extreme base vermilion-red.  $Cu_2$  and  $A_1$  do not fuse.

Operculum. — Pale-ochraceous. Slender, pointed apically; meracanthus fairly broad, sharply pointed, reaching beyond proximal part of the operculum.



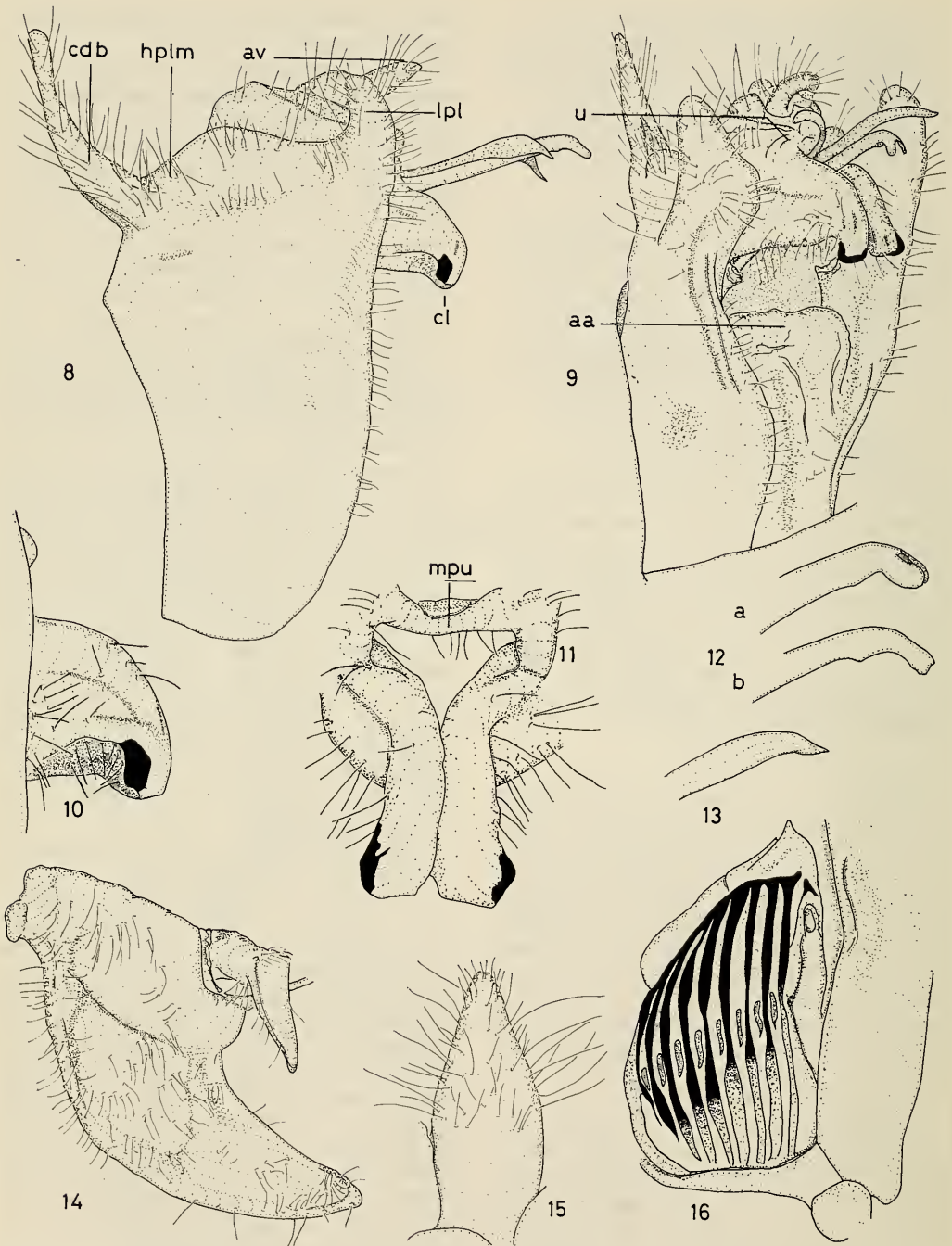

Figs. 8—16. *Prasia faticina*, ♂, Patunuang. 8, pygofer, ventral view (av = anal valves, cdb = caudal dorsal beak, cl = clasper, hplm = hindpart lateral margin, lpl = lateral pygofer lobe); 9, pygofer, ventrolateral view (aa = aedeagal adjustment, u = uncus); 10, clasper, lateral view; 11, uncus and claspers, ventral view (mpu = median part of uncus); 12, apex of aedeagus, 12a, laterodorsal view, 12b, lateral view; 13, apex of aedeagal appendage process; 14, operculum, ventral view; 15, sternite 8, ventral view; 16, tymbal, lateral view.

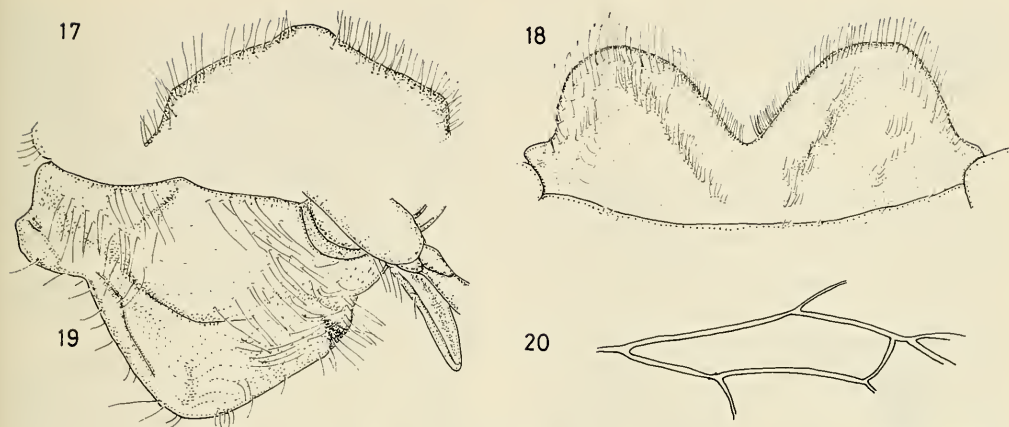

Figs. 17—20. *Prasia faticina*; 17, ♂ Patunuang; 18—20, ♀ Patunuang. 17, edge of sternite 1, ventral view; 18, sternite 7, ventral view; 19, operculum, ventral view; 20, 3rd ulnar area of right tegmen.

Abdomen. — Tergites dark- or light-brown, with orange-red hindmargins. In darker specimens hindmargins of sternites 3—7 greyish-brown, and tergites with pale lateral spots. Tergite 1 trapezoid with sharp proximal and obtuse distal angles. Hindmargin of tergite 1 twice as long as medial length of tergite. Tergite 3 longest. Sternite 8 apically pointed.

Tymbals. — Medium-sized, provided with 8 chocolate-brown long ridges alternating with short orange-brown medial ridges, of which the smallest one is sometimes hardly visible.

Genitalia. — Lateral lobes in lateral view swollen and pointed, in ventral view basally swollen, apically slender and pointed. Caudal dorsal beak at a slight angle with dorsal part of the pygofer. Claspers in lateral view very broad and strongly curved apically; hardly elongate. Uncus as in fig. 11, with a small or hardly developed medial protuberance. Aedeagus slender with slender, slightly dentate, short apical lobes. Adjustment of aedeagus situated at half the length of the pygofer. Dorsal aedeagal appendage originating at about 2/3 of aedeagus length and split in two slender, apically pointed, processes at about 2/3 of its own length, these processes not reaching apex of aedeagus.

♀. Tegmina and wings. — Tegmina subhyaline with an orange-brownish tinge; extreme base pale-red. Costal membrane white. Venation pale-ochraceous, basal area infuscated. Third ulnar area (sometimes shaped as in fig. 20)  $0.55\text{--}0.74 \times$  as long as 1st ulnar area; 4th ulnar area  $0.62\text{--}0.66 \times$  as long as radial area. Apical areas as in males, 3rd apical area  $0.55\text{--}0.69 \times$

as long as 4th one. Hardly any indication of a transverse vein extending from the 2nd ulnar area into the 3rd.

Wings pale hyaline, colour of venation as in tegmina, extreme base pale-red.  $Cu_2$  and  $A_1$  do not fuse.

Operculum. — Pale-ochraceous, rounded in holotype, more of a pointed shape in the other female specimens. Meracanthus as in males.

Abdomen. — Orange-brown with sometimes an olivaceous tinge, especially on the weakly carinated medio-dorsal "ridge". Caudal dorsal beak slender. Ovipositor sheath not reaching beyond caudal dorsal beak. Sternite 7 as in fig. 18. Measurements based upon all specimens available: body length ♂: 19.6—23.8 mm,  $\bar{x} = 22.3$ ,  $\sigma = 1.727$ , ♀: 24.6—26.2 mm,  $\bar{x} = 25.4$ ,  $\sigma = 0.583$ ; width of pronotum collar ♂: 7.2—8.3 mm,  $\bar{x} = 7.7$ ,  $\sigma = 0.339$ , ♀: 9—9.6 mm,  $\bar{x} = 9.3$ ,  $\sigma = 0.286$ ; tegmen length ♂: 26.1—31.2 mm,  $\bar{x} = 28.5$ ,  $\sigma = 1.305$ , ♀: 34.9—37.9 mm,  $\bar{x} = 36.0$ ,  $\sigma = 1.190$ .

Distribution. — South Sulawesi (Patunuang, Ujung Pandang (= Makassar)) (fig. 7).

Material examined. — Indonesia, Sulawesi: Patunuang, H. Fruhstorfer, i. 1896, 1 ♂ lectotype of *Prasia culta* (BM), 1 ♂ paralectotype of *Prasia culta* (BM), 4 ♂ 2 ♀ (CNMW), same data but with: 1909—21, *Prasia* sp., 1 ♀ (BM), same data but with: *Prasia* Dist.; 1910—6, coll. A. Jacobi, 1 ♂ (SMD), same data but with: *Prasia culta*, 1 ♂ (AMS), same data but with: *Drepanopsaltria culta*, 1 ♂ (DEI), same data but with: *Drepanopsaltria culta* Dist., 1 ♂ (TMB), "Mak" (= Makassar, now Ujung Pandang, blue round label, handwritten), "Celeb/Wallace" (partly print, partly

handwritten), "*faticina*. Stål" (handwritten), "67/66" (handwritten, blue round label), "syntype" (print, blue edged, round label), 1 ♀, holotype of *Prasia faticina* (BM).

#### Remarks.

*P. faticina* is closely related to *P. breddini* n. sp., and differences between these species are only small. Two other very closely related species are *P. tuberculata* n. sp. and *P. sarasinorum* n. sp., which are easier discerned from *P. faticina*. Among the males of *P. faticina* are very dark and light coloured specimens. Since, however, their genitalia are all alike, and no other structural differences have been found, I have refrained from a taxonomic separation between the two colour forms.

#### *Prasia breddini* n. sp.

(figs. 7, 21—30)

Since *Prasia breddini* resembles *P. faticina* in almost every respect, a differential description is presented. The species is described after two male specimens.

#### Description of the male.

Body of male dark, holotype a little paler than a dark coloured *P. faticina* specimen. Head and pronotum together 1.1—1.11 × as long as meso- and metanotum together. Thorax and head together 0.77 × as long as abdomen. Greatest width of the body at the height of the 3rd abdominal segment.

Head. — Uniformly brown, with a dorsal medial longitudinal pale line on postclypeus. Eyes 0.71—0.79 × as wide as vertex width between eyes. Distance between lateral ocelli 1—1.25 × as long as distance between lateral ocellus and eye. Head 1.69—1.72 × as long as vertex width between eyes. Head 2.42—2.58 × as wide as vertex width between eyes. Transverse ridges less distinct than in dark *P. faticina* specimens. Head in lateral view more rounded than in *P. faticina*. Rostrum reaching intermediate trochanter.

Thorax. — Coloration of pronotum intermediate between dark and lighter coloured *P. faticina* specimens. Pronotum collar 1.91—1.92 × as wide as head including eyes. Mesonotum pale-brown with patches indicating four obconical areas, except for a brown spot in front of cruciform elevation. Ventral surface with thicker hairs than in *P. faticina*.

Legs. — Shape as in *P. faticina*, fore tibiae and tarsi only slightly darker than femora.

Tegmina and wings. — Third ulnar area 0.63 × as long as 1st one; 4th ulnar area 0.62—0.67 × as long as radial area. 3rd apical area 0.61 × as long as 4th one.

Operculum. — As in *P. faticina*. General appearance only slightly broader.

Abdomen. — In holotype paler than the dark coloured *P. faticina* specimens, in paratype fairly dark. Sternites with broad, orange-brown to red coloured hindmargins.

Tymbals. — Eight pairs of alternating ridges, the smallest short ridge is, as may be found in *P. faticina*, hardly visible.

Genitalia. — Pygofer more sturdy than in *P. faticina*. Claspers elongate and not strongly curved apically; its dark brown apex pointed. Median part of uncus above aedeagus broader than in *P. faticina*; sometimes provided with a small medial protuberance. Dorsal part of uncus raised high above the lateral margin of the pygofer. Aedeagus longer and stouter than in *P. faticina*, its apical lobes longer and less slender; dentate. Adjustment of aedeagus at half the length of the pygofer. Pointed processes of dorsal aedeagal appendage somewhat broader than in *P. faticina*.

Measurements of the ♂ types: body length: 22.3 mm; width of pronotum collar: 7.6—8.2 mm; tegmen length: 29.5 mm.

Distribution. — The male holotype has been collected in Ussu, Central Sulawesi, near Malili. The paratype is from Palopo, Central Sulawesi (fig. 7).

Types. — Indonesia, Sulawesi: "Celebes/ Ussu/ leg. Dres. Sarasin" (handwritten), "Ussu" (handwritten), "1910/ 6" (partly print, partly handwritten), "coll. A. Jacobi" (print), "Staatl. Museum für/ Tierkunde Dresden" (print), 1 ♂, holotype of *Prasia breddini* (SMD); Palopo, Celebes, 1 ♂ paratype of *Prasia breddini* (MZB).

Etymology. — The species is named after the German hemipterologist Dr. Gustav Breddin, who recognized the separate taxonomic position of *Prasia* as defined in his description of *Drepanopsaltria*.

#### Remarks.

Differences between *P. breddini* and *P. faticina* are mainly found in the genital structures of the two species. As the differences are very slight, the species are probably very closely related.

There are several female specimens that may be attributed to *P. breddini*. The supposed taxonomic position of some unidentified females



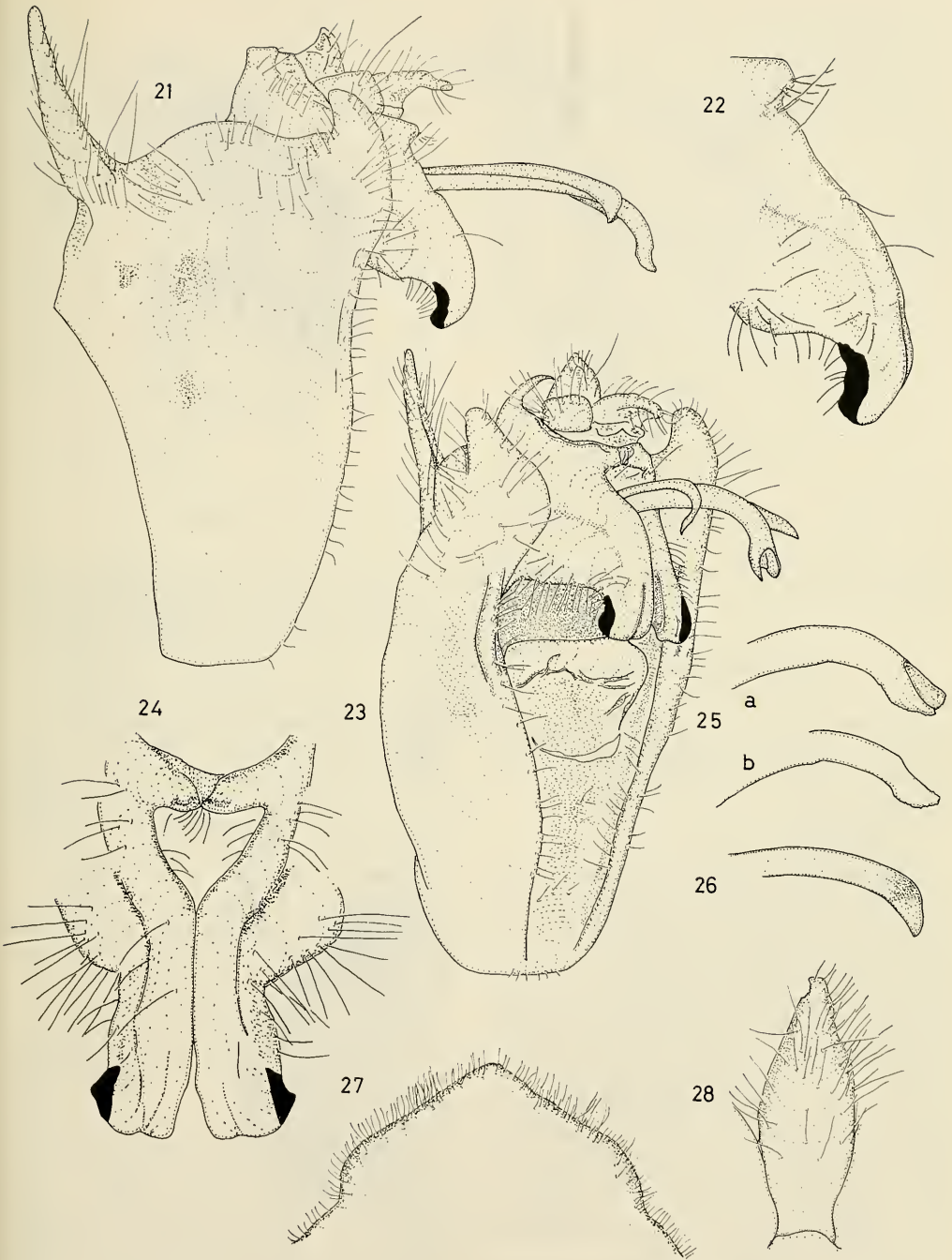

Figs. 21—28. *Prasia breddini*, holotype. 21, pygofer, lateral view; 22, clasper, lateral view; 23, pygofer, ventro-lateral view; 24, uncus, ventral view; 25, apex of aedeagus, 25a, laterodorsal view, 25b, lateral view; 26, apex of aedeagal appendage process; 27, edge of sternite 1, ventral view; 28, sternite 8, ventral view.

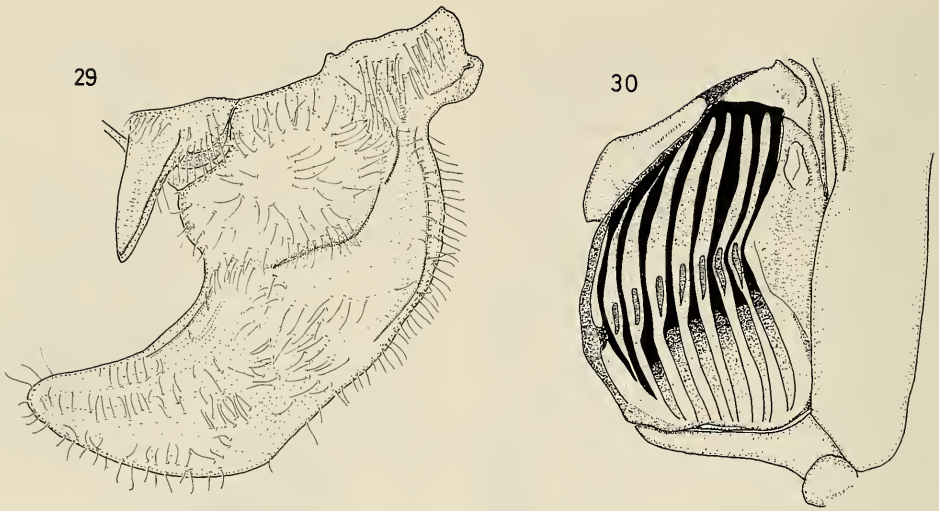

Figs. 29, 30. *Prasia breddini*, holotype. 29, operculum, ventral view; 30, tymbal, lateral view.

will be discussed in the remarks of *P. sarasinorum* n. sp.

***Prasia sarasinorum* n. sp.**  
(figs. 7, 31—40, 88)

The differential description of *P. sarasinorum* hereafter is made in comparison with *P. faticina*. The species is described after four male specimens.

Description of the male.

Body pale-orange-brown. Specimens studied without traces of a dark coloured fascia on the pronotum. Ventrally a little paler than dorsally. Head and pronotum together  $1.12-1.21 \times$  as long as meso- and metanotum together. Thorax and head together  $0.79 \times$  as long as abdomen. Greatest width of body at the height of either the 3rd abdominal segment or pronotum collar.

Head. — Slightly darker between eyes. Eyes  $0.78-0.84 \times$  as wide as vertex between eyes. Distance between lateral ocelli  $0.91-1.52 \times$  as long as distance between eye and lateral ocellus. Head  $1.85-2 \times$  as long as vertex width between eyes. Width of head  $2.57-2.68 \times$  as wide as vertex between eyes. Rostrum reaching beyond intermediate coxae.

Thorax. — Pronotum unicolorous, sometimes a little darker on pronotum collar, especially at the lateral corners. Pronotum collar  $1.88-2.01 \times$  as wide as head including eyes. Mesonotum in only one specimen unicolorous,

which seems to be the natural coloration, since the other specimens (with odd patches) have been kept in alcohol for some time. Ventral surface of thorax with thicker hairs than in *P. faticina*.

Legs. — As in *P. faticina*, but fore tibiae and tarsi less conspicuously darker coloured.

Tegmina and wings. — Third ulnar area  $0.66-0.71 \times$  as long as 1st one; 4th ulnar area  $0.64-0.71 \times$  as long as radial area. Third apical area  $0.67-0.69 \times$  as long as 4th one.

Operculum. — Broader than in *P. faticina*; apex distinctly rounded.

Abdomen. — Tergites orange-brown, sternites only a little paler. Tergites 3—6 only with small red, sternites with broad red hindmargins. Sternite 1 laterally almost straight. Sternite 8 apically less pointed than in *P. faticina*.

Tymbals. — Eight long ridges alternating with short ridges, smallest short one mostly distinctly visible, and even a 9th long ridge sometimes discernable.

Genitalia. — Pygofer small compared to *P. faticina*. Caudal dorsal beak shorter than in *P. faticina*. Lateral margins of pygofer in between caudal dorsal beak and each of the lateral lobes hardly, though distinctly, degrading. Lateral lobes a little smaller than in *P. faticina*. Claspers in lateral view more elongate and apically dark, hardly curved. Aedeagus in general appearance more sturdy than in *P. faticina*. Apical lobes of aedeagus very short and broad; dentate. Adjustment of aedeagus situated less than

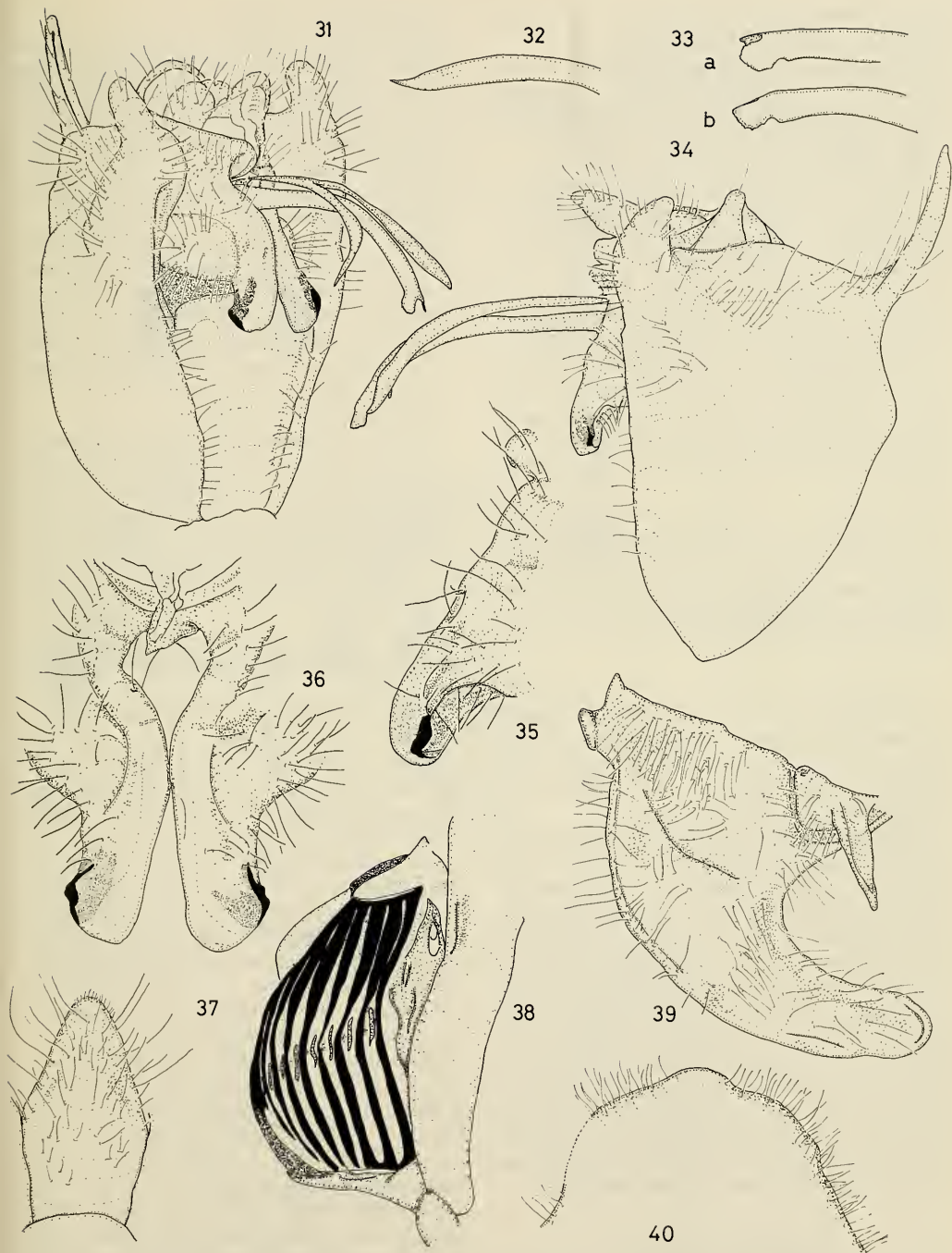

Figs. 31—40. *Prasia sarasinorum*. 31, pygofer, ventrolateral view, holotype; 32, apex of aedeagal appendage process, holotype; 33, apex of aedeagus, 33a, laterodorsal view, 33b, lateral view, holotype; 34, pygofer, lateral view, holotype; 35, clasper, lateral view, holotype; 36, uncus, ventral view, holotype; 37, sternite 8, ventral view, holotype; 38, tymbal, lateral view, paratype Mapane; 39, operculum, ventral view, paratype Mapane; 40, edge of sternite 1, ventral view, holotype.



halfway the length of the pygofer. Processes of dorsal aedeagus appendage pointed.

Measurements of the ♂ types: body length: 22.9—23.2 mm ( $n = 2$ ); width of pronotum collar: 7.9—8.3 mm,  $\bar{x} = 8.1$ ,  $\sigma = 0.145$ ; tegmen length: 28.5—28.9 mm,  $\bar{x} = 28.8$ ,  $\sigma = 0.189$ .

Distribution. — Central Sulawesi (fig. 7).

Types. — Indonesia, Sulawesi: "Celebes/Mapane & Umgebg/ii.95 (Dres. Sarasin)" (handwritten), "*Prasia/Distanti/Bred.*" (handwritten), "*Prasia culta?*" (handwritten), „Distant Coll./1911—383." (print), 1 ♂, holotype of *Prasia sarasinorum* (BM); Mapane & surroundings, Dres. Sarasin, ii. 95, coll. A. Jacobi, 1910—6, 1 ♂ paratype of *Prasia sarasinorum* (SMD), same locality and collector but with: coll. Breddin, 1 ♂ paratype of *Prasia sarasinorum* (DEI); Posso (near lake), ii.95, Dres. Sarasin, coll. Breddin, 1 ♂ paratype of *Prasia sarasinorum* (DEI).

Etymology. — This species is named after the Sarasin brothers, in recognition of their contributions to our knowledge of the fauna of Sulawesi by their collecting activities and important publications on the biogeography of the island (e.g. Sarasin & Sarasin, 1901).

#### Remarks.

The species is easily recognized by its rounded opercula, the apex of the aedeagus, and the lacking of dark coloured central fascia on the pronotum. The character last mentioned is shared with *P. tuberculata* n. sp.

The material collected by the Sarasin brothers also contained two females, one from the surroundings of Lake Posso and one from the southern headlands of the Takalekadjo Range in Central Sulawesi. These are characterized by a slender tergite 9 and the ovipositor sheath being longer than in any other *Prasia* female. As there is another female specimen from Tentena, that is different from both specimens collected by the Sarasins, it is impossible to attribute these three females to any species yet, regarding *P. sarasinorum*, *P. senilirata* n. sp. and *P. breddini* in particular, since these three species are recorded from Central Sulawesi. More material may lead to a proper identification of these females.

#### *Prasia tuberculata* n. sp.

(figs. 7, 41—50)

The differential description, after the male holotype, is made in comparison with *P. faticina*.

#### Description of the male.

Body brown coloured. Ventrally paler than dorsally. Head somewhat darker. Holotype without traces of dark coloured fascia on the pronotum. Head and pronotum together  $1.05 \times$  as long as meso- and metanotum together. Thorax and head together  $0.78 \times$  as long as abdomen. Greatest width of the body at the height of the 3rd abdominal segment.

Head. — Slightly darker between ocelli. Eyes  $0.72 \times$  as wide as vertex between eyes. Distance between lateral ocelli  $1.2 \times$  distance between lateral ocellus and eye. Head  $1.78 \times$  as long as width of vertex between eyes. Width of head  $2.43 \times$  width of vertex between eyes. Postclypeus ventrally pale coloured. Rostrum just reaching intermediate trochanter.

Thorax. — Pronotum on the whole unicolorous, somewhat darker coloured on the pronotum collar, especially at the lateral corners. Pronotum collar  $1.86 \times$  as wide as width of head including eyes. Mesonotum, with the four obconical areas slightly lighter coloured, concolorous. Cruciform elevation slightly darker coloured.

Legs. — As in *P. faticina*, the fore tibiae and tarsi only being slightly darker than the remainder.

Tegmina and wings. — Costal membrane not as dark as in *P. faticina*. Third ulnar area (shaped as in fig. 20)  $0.81 \times$  as long as 1st one; 4th ulnar area  $0.66 \times$  as long as radial area. Apical areas 4, 5, 6 and 7 longest. Third apical area  $0.66 \times$  as long as 4th one.

Operculum. — As in *P. faticina*, meracanthus more slender.

Abdomen. — Tergites brown, sternites only a little paler. Tergites 3—6 only with small red, sternites with broad pale-red hindmargins. Sternite 8 far less pointed.

Tymbal. — Seven long ridges alternating with an equal number of short ridges.

Genitalia. — Pygofer small compared to *P. faticina*. Caudal dorsal beak mutilated. Lateral margins of pygofer hardly, though distinctly, degrading. Lateral lobes a little smaller, in ventral view more pointed. Claspers in lateral view apically slender, but with a distinct swelling dorsally. Median uncus part small, without protuberance. Apex of aedeagus longer than in *P. faticina*; aedeagus slender. Adjustment of aedeagus situated slightly lower in comparison with *P. faticina*. Processes of dorsal aedeagal appendage very slender and pointed apically.

Measurements of the holotype: body length:



Figs. 41—48. *Prasia tuberculata*, holotype. 41, uncus, ventral view; 42, pygofer, lateral view; 43, clasper, lateral view; 44, pygofer, ventrolateral view; 45, apex of aedeagal appendage process; 46, apex of aedeagus, 46a, latero-dorsal view, 46b, lateral view; 47, operculum, ventral view; 48, sternite 8, ventral view.

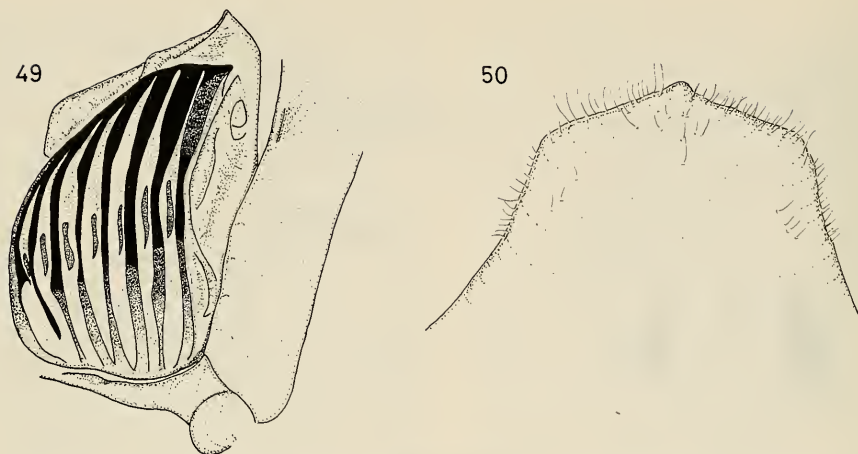

Figs. 49, 50. *Prasia tuberculata*, holotype. 49, tymbal, lateral view; 50, edge of sternite 1, ventral view.

22.8 mm; width of pronotum collar: 7.6 mm; tegmen length: 27.4 mm.

Distribution. — The holotype is from Tombugu (= Tombuko) in East Sulawesi (fig. 7).

Type. — Indonesia, Sulawesi: "Ost-Celebes/Tombugu/H. Kühn 1885" (print, black cadre), 1 ♂ (MNP).

Etymology. — The species is named after its swelling on the clasper, when looked at laterally. "Tuberculata" is Latin for swollen.

#### Remarks.

At first sight this species is easily mixed up with *P. sarasinorum*, because of the lacking of coloration of the central fascia on the pronotum. Its genitalia, however, are very different from the species mentioned, and its opercula are pointed, whilst in *P. sarasinorum* they are rounded apically. The apex of the aedeagus seems a sort of combination between *P. faticina* and *P. sarasinorum*. The number of long ridges is the same as in *P. nigropercula*.

#### *Prasia nigropercula* n. sp.

(figs. 6, 7, 51—59, 89)

The description is made in comparison with *P. faticina* and based upon the single male specimen from Muna Island, situated near the southeastern arm of Sulawesi.

#### Description of the male.

Body fairly dark coloured, especially head, pronotum collar, central fascia and obconical spots on mesonotum. Head and pronotum to-

gether  $1.34 \times$  as long as meso- and metanotum together. Head and thorax together  $0.78 \times$  as long as abdomen. Greatest width of body at the height of pronotum collar.

Head. — Dark-brown, ocelli on a black underground. Head (a little damaged) much porrect. Eyes  $0.67 \times$  as wide as vertex width between eyes. Distance between lateral ocelli  $1.1 \times$  distance between eye and lateral ocellus. Head  $1.82 \times$  as long as width of vertex between eyes. Head  $2.34 \times$  as wide as vertex between eyes. Postclypeus in ventral view darkening distad. Rostrum reaching intermediate coxae.

Thorax. — Pronotum collar, lateral margin of pronotum, central fascia and some spots on the pronotum dark-brown coloured. Pronotum collar more or less pointed at the lateral corners,  $1.96 \times$  as wide as head including eyes. Mesonotum with six dark-brown coloured areas at proximal margin, two paramedian ones half as long as more lateral ones, which join broadly in front of cruciform elevation. Cruciform elevation dark-brown for its greater part. Metanotum dark-brown. Ventrally pale ochraceous.

Legs. — As in *P. faticina*.

Tegmina and wings. — Venation and costal membrane dark-brown. Third ulnar area  $0.7 \times$  as long as 1st one; 4th ulnar area  $0.67 \times$  as long as radial area. Third apical area  $0.66 \times$  as long as 4th one. Traces of coloration of transverse vein present.

Operculum. — Dark, nearly black. Smaller than in *P. faticina*; acutely pointed. Meracanthus dark coloured, size as in *P. faticina*.



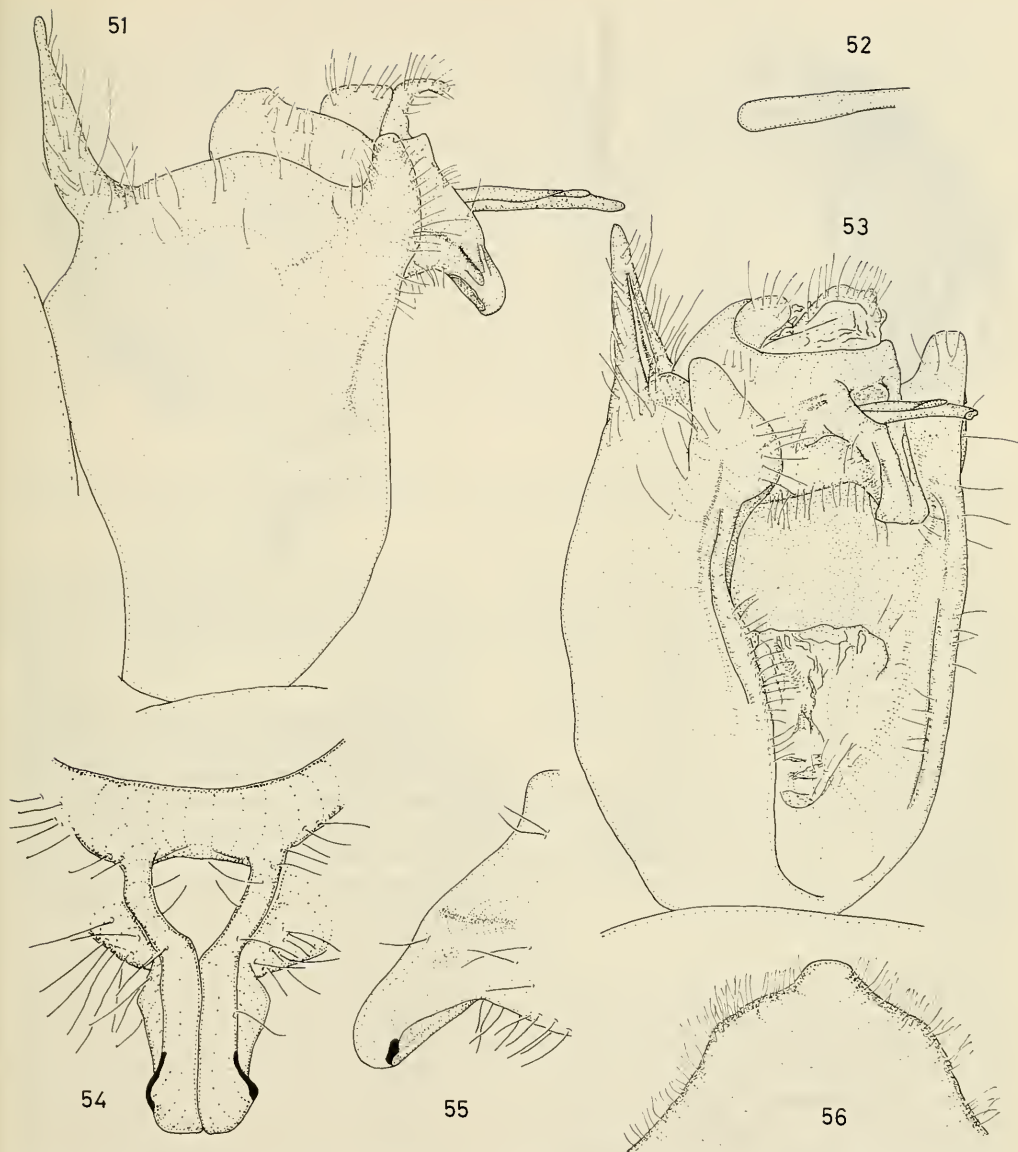

Figs. 51—56. *Prasia nigropercula*, holotype. 51, pygofer, lateral view; 52, apex of aedeagal appendage process; 53, pygofer, ventrolateral view; 54, uncus, ventral view; 55, clasper, lateral view; 56, edge of sternite 1, ventral view.

Abdomen. — Dark-brown coloured with red hindmargins, along tergites as well as sternites. Tergite 1 for its greater part covered by metanotum. Sternite 1 apically somewhat smaller and laterally more concave than in *P. faticina*; median protuberance more conspicuous. Sternite 8 hardly pointed apically.

Tymbals. — Seven long ridges alternating with an equal number of short medial ridges.

Genitalia. — Caudal dorsal beak almost in a straight line with dorsal part of pygofer. Lateral lobes smaller than in *P. faticina*. Median uncus part above aedeagus broad. Claspers slender, somewhat elongate, hardly curved and apically

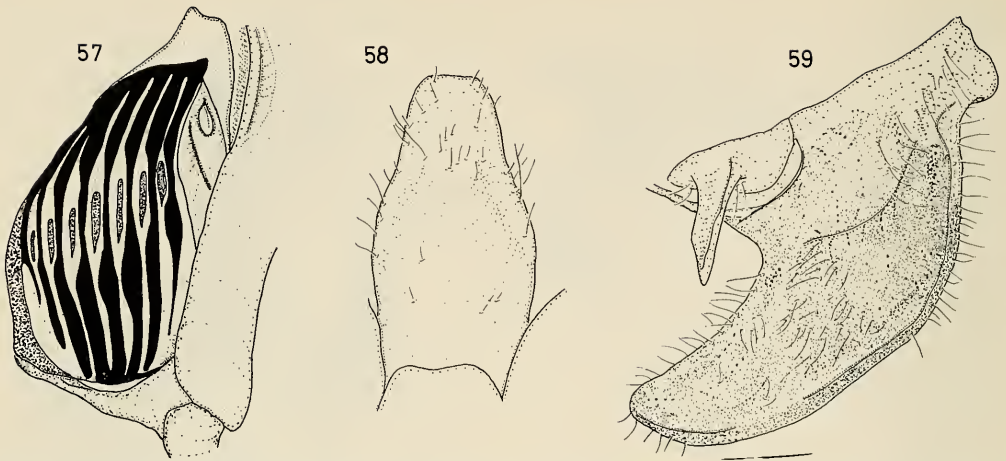

Figs. 57—59. *Prasia nigropercula*, holotype. 57, tymbal, lateral view; 58, sternite 8, ventral view; 59, operculum, ventral view.

rounded. Aedeagus extremely slender (apex mutilated). Adjustment of aedeagus situated less than halfway the pygofer. Processes of dorsal aedeagal appendage apically rounded.

Measurements of the holotype: body length: 23.4 mm; width of pronotum collar: 8.4 mm; tegmen length: 28.4 mm.

Distribution. — Muna (Raha) (fig. 7).

Type. — Indonesia, Muna: "Raha/Moena/Ile Celebes" (handwritten), 1 ♂ (BIN).

Etymology. — The species is named after its nearly black coloured operculum, that contrasts with the pale underside of the body.

#### Remarks.

Beside its conspicuous coloration, the species is very distinct within the genus because of some characteristic details in the genitalia structures, viz. the shape of the claspers and the adjustment of the aedeagus, as well as the apically rounded processes of the aedeagal appendage. The shape of the clasper, though, is reminiscent of that of *P. sarasinorum*.

A female from Kandari (= Kendari?), which has probably lost the natural coloration, has about the pronotum collar shape of *P. nigropercula*. Since the material is too scanty, this specimen is still regarded as unidentified.

#### *Prasia princeps* Distant, 1888 (figs. 7, 60—75, 90, 91)

*Prasia princeps* Distant, 1888: 325; Distant, 1892: xiv, 145, pl. 13, figs. 14, 14a, b; Jacobi, 1903: 12; Distant, 1906: 184 (equals *Drepanopsaltria* (?) *prin-*

*ceps* Bredd.); Kato, 1932: 189; Metcalf, 1963: 425. *Drepanopsaltria* (?) *princeps*; Breddin, 1901: 28, 113. *Drepanopsaltria princeps*; Jacobi, 1903: 10.

#### Description.

Body olivaceous-green to green, sometimes with a brownish tinge. Head darker coloured. Body ventrally somewhat paler than dorsally. Head and pronotum together  $0.96\text{--}1.22 \times$  as long as meso- and metanotum together. Female thorax and head together  $0.81\text{--}1.02 \times$  as long as abdomen; male  $0.69\text{--}0.75 \times$  as long. Greatest width of the body at the height of the 3rd abdominal segment.

Head. — Dorsally olivaceous with brown between eyes. Eyes large,  $0.67\text{--}0.88 \times$  as wide as vertex width between eyes. Ocelli raised. Distance between lateral ocelli  $0.86\text{--}1.53 \times$  distance between eye and lateral ocellus. Head  $1.63\text{--}1.98 \times$  as long as width of vertex between eyes. Head  $2.35\text{--}2.76 \times$  as wide as vertex between eyes. Postclypeus in ventral view strongly laterally compressed, olivaceous- to light-brown coloured. Transverse ridges weak, colorous. Rostrum with black apex reaching intermediate coxae.

Thorax. — Central fascia on pronotum collar obsolete; pronotum collar broadly rounded,  $1.84\text{--}2.11 \times$  as wide as width of head including eyes. Fissures on pronotum undep. A lateral brown line running from each eye backwards, almost reaching latero-proximal corner of pronotum collar. Mesonotum with four speckled obconical areas at proximal margin; the para-

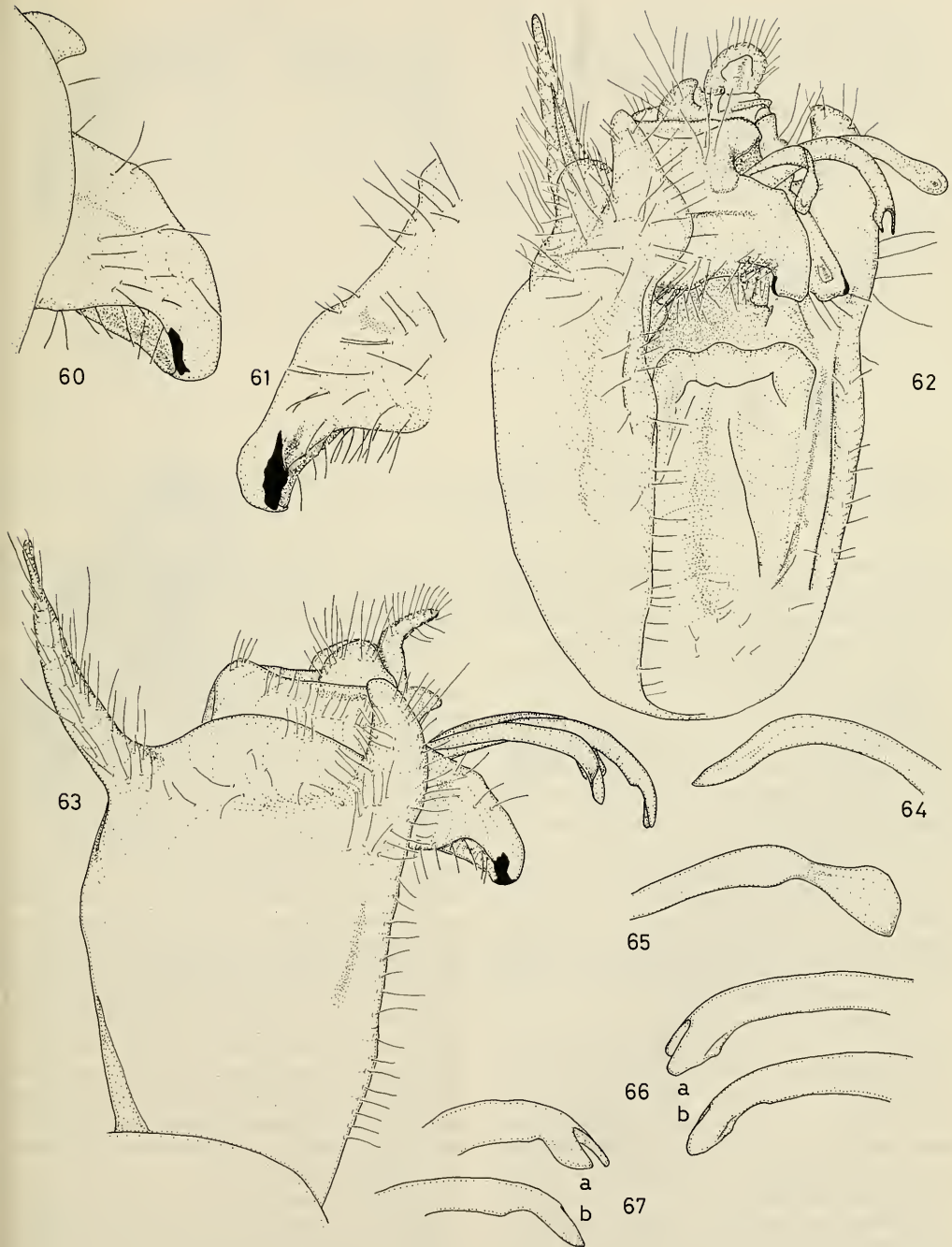

Figs. 60—67. *Prasia princeps*, ♂. 60, 61, clasper, lateral view, 60, Menado, 61, Toli-Toli; 62, 63, pygofer, ventro-lateral (62) and lateral (63) view, Tanggarie-Menado; 64, 65, apex of aedeagal appendage process, 64, Toli-Toli, 65, Menado; 66, apex of aedeagus, 66a, laterodorsal view, 66b, lateral view, Toli-Toli; 67, apex of aedeagus, 67a, laterodorsal view, 67b, lateral view, Menado.



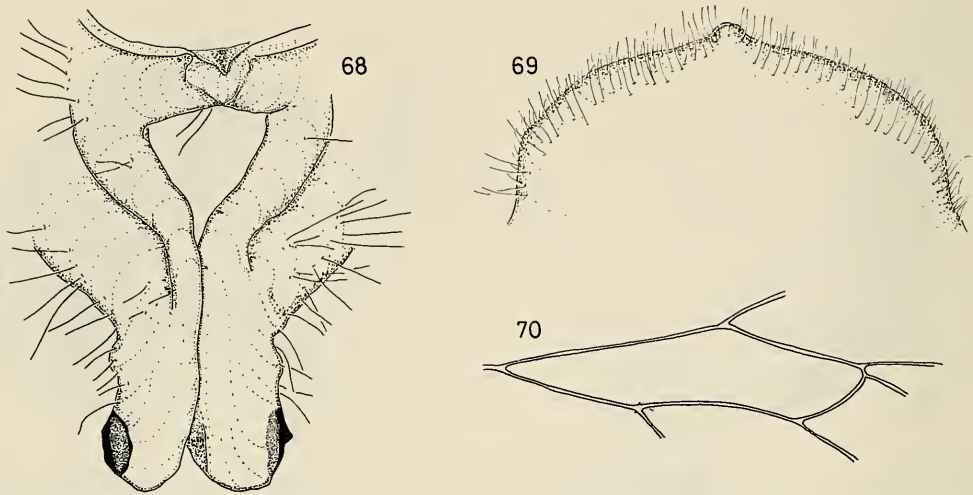

Figs. 68—70. *Prasia princeps*: 68, 69, ♂; 70, ♀. 68, uncus, ventral view, Menado; 69, edge of sternite 1, ventral view, Menado; 70, 3rd ulnar area of right tegmen, Toli-Toli.

median areas being half as long as the lateral ones, whose length is about  $3/4$  of the disk. Cruciform elevation fairly flattened. Metanotum just extending from below mesonotum.

Legs. — Concolorous, except fore tibiae and tarsi, which are brownish.

♂. Tegmina and wings. — Tegmina very pale-ochraceous or olivaceous, subhyaline. Costal membrane olivaceous. Extreme base red. Apical areas of tegmen long, 4th, 5th and 6th longest, 1st, 3rd and 7th shorter, 2nd and 8th shortest. Third apical area  $0.58-0.69 \times$  as long as 4th one. Third ulnar area (sometimes shaped as in fig. 70)  $0.7-0.87 \times$  as long as 1st one; 4th ulnar area  $0.63-0.76 \times$  as long as radial area. Hardly any indication of a corial fold, nor of any remnant of a transverse vein extending from the 2nd ulnar area into the 3rd.

Wings pale hyaline, venation ochraceous, extreme base red.  $Cu_2$  and  $A_1$  veins fused just before the wing border.

Operculum. — Large, sickle-shaped, broad and pointed, just reaching or reaching just beyond sternite 2, concolorous. Meracanthus short and slender, not reaching beyond proximal part of operculum.

Abdomen. — Sometimes irregularly speckled with light patches, fresh specimens unicolorous. Tergite 1 trapezoid with sharp proximal and obtuse distal angles. Hindmargins of tergites orange-brown coloured. Distal edge of sternite 1 convex with a weak median bulb. Sternite 8 apically slightly to hardly pointed.

Tymbals. — Medium-sized and consisting of 9 (sometimes 10 and one male from Toli-Toli 8) long ridges alternating with short medial brown ridges in a very regular pattern.

Genitalia. — Lateral lobes of the pygofer in lateral view swollen and pointed, in ventral view swollen, apically slender and pointed. Caudal dorsal beak sometimes at an angle of at most  $40^\circ$  with dorsal part of pygofer. Claspers in lateral view broad, sometimes more narrowly shaped, somewhat elongate, apically curved and pointed; in dorsal view median part slender and apically swollen. Uncus consisting of two lateral, slightly swollen parts and mostly of a medial protuberance. Greater part of the aedeagus slender. Dorsal aedeagal appendage originating at about  $2/3$  of the aedeagal length, and split at about  $2/3$  of its own length in two slender processes, which are apically rounded or pointed. These processes not reaching apex of aedeagus. The rounded ones mostly slightly constricted subapically. Apex of aedeagus consisting of two lateral slender, or somewhat broader lobes, that are dentate apically. Adjustment of aedeagus situated halfway the pygofer.

♀. Tegmina and wings. — Tegmina pale-ochraceous or olivaceous, subhyaline. Costal membrane white. Extreme base red. Apical areas as in males. Third apical area  $0.61-0.71 \times$  as long as 4th one. Third ulnar area (sometimes shaped as in fig. 70)  $0.59-0.76 \times$  as long as 1st one; 4th ulnar area  $0.67-0.77 \times$  as long as radial area. Hardly any indication of the corial

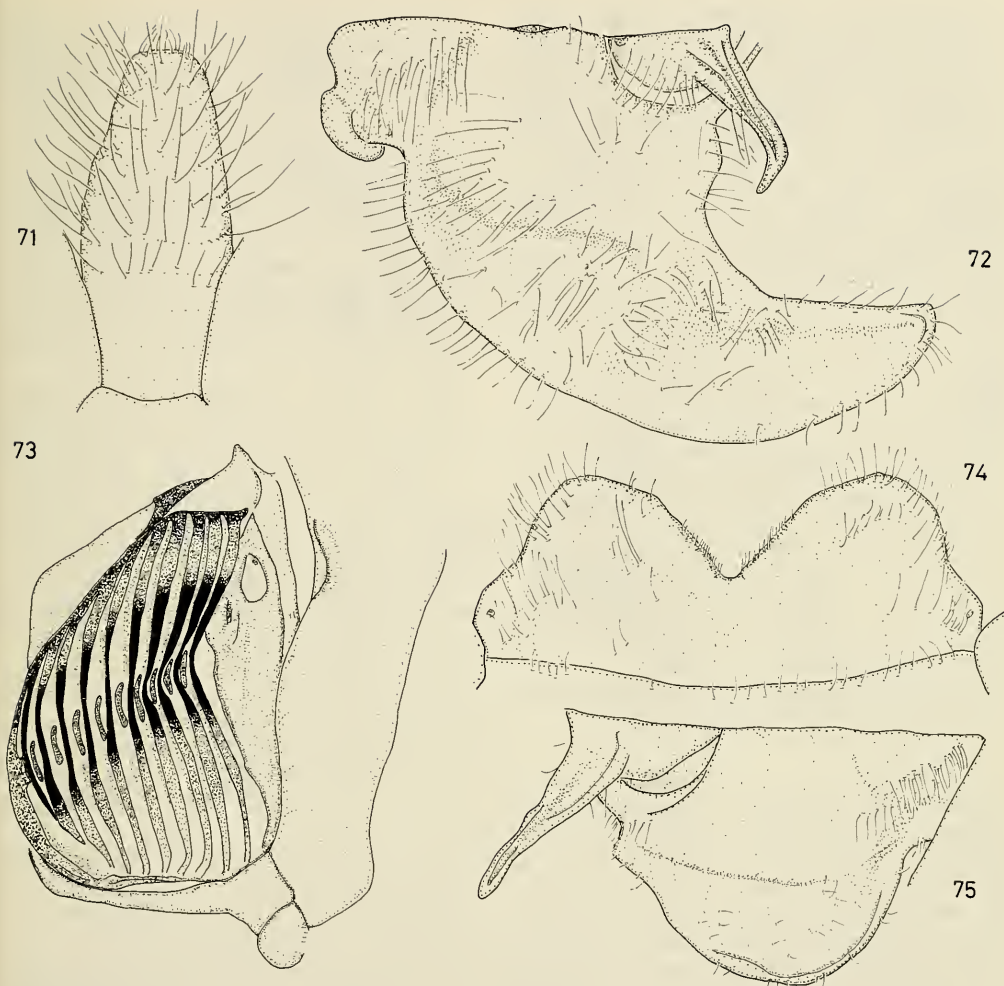

Figs. 71—75. *Prasia princeps*; 71—73, ♂; 74, 75, ♀. 71, sternite 8, ventral view, Menado; 72, operculum, ventral view, Minahassa; 73, tymbal, lateral view, Menado; 74, sternite 7, ventral view, Menado; 75, operculum, ventral view, Woloan-Menado.

fold, nor of any remnant of a transverse vein extending from the 2nd ulnar area into the 3rd.

Wings pale-hyaline, venation ochraceous, extreme base pink.  $Cu_2$  and  $A_1$  fused in nearly all specimens (including the type!) just before the wing border.

Operculum. — Short, more or less broadly rounded; distal part sometimes shorter than the basal part. Meracanthus reaching just beyond posterior margin of operculum.

Abdomen. — Olivaceous, greenish, sometimes slightly brownish tinged, fresh specimens green. Broad tergites, weakly carinate medially.

Caudal dorsal beak slender. Ovipositor sheath just reaching apex of caudal dorsal beak. Sternite 7 as in fig. 74.

Measurements based upon all specimens available: body length ♂: 24.6—28.9 mm,  $\bar{x}$  = 27.3,  $\sigma$  = 1.016, ♀: 25.9—30.2 mm,  $\bar{x}$  = 28.2,  $\sigma$  = 1.394; width of pronotum collar ♂: 8.0—9.5 mm,  $\bar{x}$  = 9.0,  $\sigma$  = 0.392, ♀: 9.3—11.3 mm,  $\bar{x}$  = 10.2,  $\sigma$  = 0.583; tegmen length ♂: 32—36.7 mm,  $\bar{x}$  = 34.5,  $\sigma$  = 1.223, ♀: 39.1—41.9 mm,  $\bar{x}$  = 40.6,  $\sigma$  = 0.819.

Distribution. — North Sulawesi (fig. 7).

Material examined.— Indonesia, Sulawesi: Dumoga-Bone N.P., Sulawesi Utara, Project Wallace 1985, st. 4, lowland rainforest near base camp, 29.i—2.ii.1985, at M.V. light, J. P. Duffels & J. D. Holloway collectors, 1 ♀ (MZB), same locality and collectors but with, st. 7, lowland rainforest at 120 m from st. 4, 1—2.ii.1985, at M.V. light, 1 ♀ (ZMA), 1 ♀ (MZB), same locality and collectors but with, st. 9, subcamp 1, 4—8.ii.1985, at light, 3 ♂ (ZMA), 4 ♂ (MZB); Menado, van Braeckel, *Prasia culta* Dist., det. Lallemand 1930, 3 ♂ (BIN); Minahassa, "Minahassa/Celebes" (handwritten), "Syntype" (round label, blue edged, print), "Distant Coll./1911—383" (print), 1 ♀, holotype of *Prasia princeps* (BM); Minahassa, *Prasia princeps* Dist., coll. Dr. D. MacGillivray, 1 ♀ (ZMA); Minahassa, V. d. Bergh, *Prasia faticina* Stål, coll. Dr. D. MacGillivray, 1 ♂ (ZMA); Tanggarie-Menado, Van Braeckel, *Prasia culta* Distant, det. Lallemand 1930, 1 ♂ (BIN); Toli-Toli, Nord-Celebes, Nov.-Dez. 1895, H. Fruhstorfer, 1 ♂ (CNMW), same data but with, 1909—21, 1 ♀ (BM), same data but with *Prasia faticina* Dist. 145.vii.14 (= Distant, 1892: 145, pl. 7, fig. 14), 1 ♂ (MHNG), same data but with, *Prasia princeps* dist. 145.xiii.14 (= Distant, 1892: 145, pl. 13, fig. 14), 1 ♀ (MHNG); Tondano-Menado, Van Braeckel, *Prasia culta* Distant, det. Lallemand, 1 ♂ (BIN); Woloan-Menado, 3 ♂ 1 ♀ (BIN).

Specimens without further precision of the locality: Celebes, 1 ♂ BIN; India Archipel, 1 ♀ CNMW.

#### Remarks.

At first there has been some hesitation whether or not to attribute a separate taxonomic position to the specimens from Toli-Toli. Whilst the specimens from Menado display a broad clasper, a very slender apex of the aedeagus and apically rounded processes of the aedeagal appendage (with the subapical constriction), the Toli-Toli specimens possess a narrow clasper, a broader shaped apex of the aedeagus and pointed processes of the aedeagal appendage.

Recent collecting in the Dumoga-Bone N.P. in Sulawesi Utara (during the Project Wallace Expedition) by Dr. Duffels and Dr. Holloway (Commonwealth Institute of Entomology, London) provided new material that displayed the Menado-type of genitalia as well as a mixture of the Menado- and the Toli-Toli-type. More material from Toli-Toli must prove the stability of its combination of genital characters in order to reconsider a separate taxonomic position.

#### *Prasia senilirata* n. sp.

(figs. 7, 76—85)

As *Prasia senilirata* resembles *P. princeps* in general appearance, mainly because of its size and the olivaceous-green colouring of the body,

a differential description is presented based upon the male holotype. Due to its large size the magnification ratio's of all drawings of *P. senilirata* are  $0.75 \times$  those used for the other species.

#### Description of the male.

Large species. Body colour (fresh) olivaceous-green. Head a little darker coloured. Body ventrally somewhat paler than dorsally. Head and pronotum  $1.09 \times$  as long as meso- and metanotum together. Thorax and head together  $0.76 \times$  as long as abdomen. Greatest width of the body at the height of the 3rd abdominal segment.

Head. — Dark-green with brown between the eyes. Eyes  $0.86 \times$  as wide as vertex width between eyes. Distance between lateral ocelli  $1.57 \times$  distance between lateral ocellus and eye. Head  $2.07 \times$  as long as and  $2.72 \times$  as wide as width of vertex between eyes. Postclypeus dark-coloured.

Thorax. — Pronotum collar  $1.94 \times$  as wide as head including eyes. Dark line running from the eye hindwards very short.

Legs. — As in *P. princeps*.

Tegmina and wings. — Coloration as in *P. princeps* (left tegmen of holotype has 7 apical areas). Third apical area  $0.7 \times$  as long as the 4th one. Third ulnar area  $0.83 \times$  as long as the 1st one; 4th ulnar area  $0.71 \times$  as long as the radial area.

Coloration of wings as in *P. princeps*.  $Cu_2$  and  $A_1$  veins do not fuse.

Operculum. — Relatively not as large and broad as in *P. princeps*; concolorous.

Abdomen. — Coloration as in olivaceous-green *P. princeps* specimens. Distal edge of sternite 1 smaller and far less bulbed than in *P. princeps*. Sternite 8 weakly pointed.

Tymbals. — Relatively small, consisting of 6 pair of long ridges alternating with short ridges. Upper half of the tymbal shaded with black above the small ridges.

Genitalia. — Lateral lobes less swollen than in *P. princeps*. Caudal dorsal beak at a very small angle with dorsal part of the pygofer. Clasper more elongate than in *P. princeps*. Median uncus part very slender, without protuberance. Aedeagus slender. Processes of dorsal aedeagal appendage apically pointed. Apex of aedeagus with two broadened flaps, that have a slight curvature.

Measurements of the holotype: body length: 29.7 mm; width of pronotum collar: 9.9 mm; tegmen length: 36.2 mm.



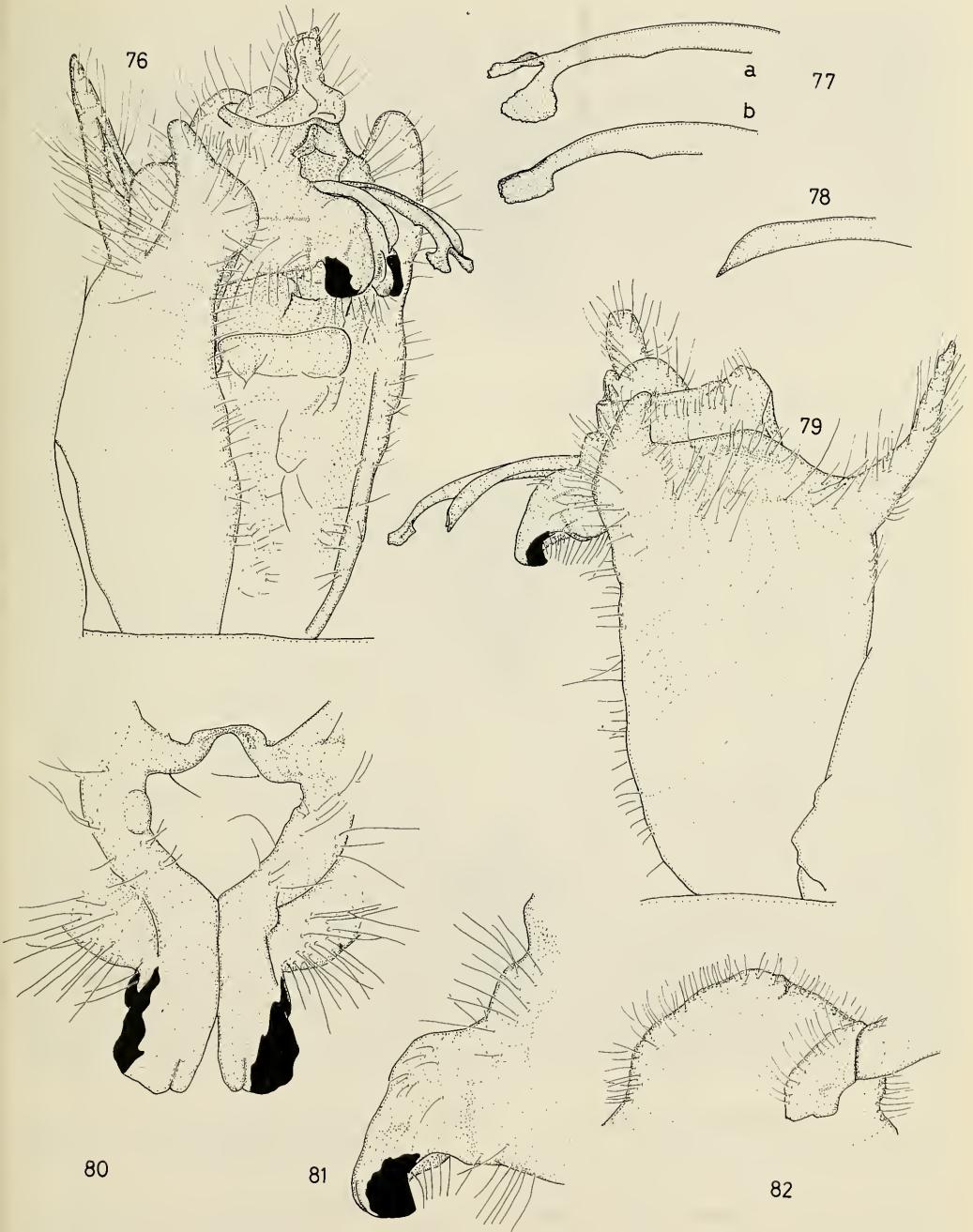

Figs. 76—82. *Prasia senilirata*, holotype. 76, pygofer, ventrolateral view; 77, apex of aedeagus, 77a, laterodorsal view, 77b, lateral view; 78, apex of aedeagal appendage process; 79, pygofer, lateral view; 80, uncus, ventral view; 81, clasper, lateral view; 82, edge of sternite 1, ventral view.

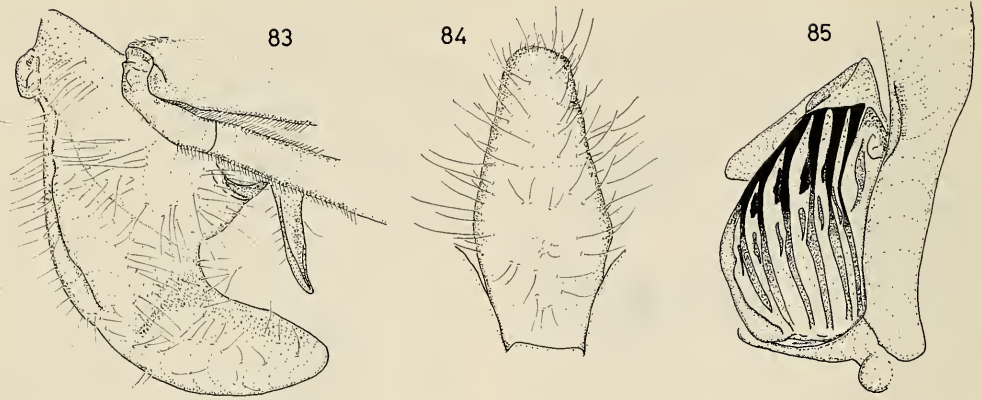

Figs. 83—85. *Prasia senilirata*, holotype. 83, operculum, ventral view; 84, sternite 8, ventral view; 85, tymbal, lateral view.

Distribution. — The holotype is from Central Sulawesi (Lore Lindu National Park) (fig. 7).

Type. — Indonesia, Sulawesi: "Stat. 44/Lowland/rainforest/ML-light" (print), "Toke Pangana/700 m/4 km NE Gimpu/16.iii.1985/J. P. & M. J. Duffels" (print), "Indonesia/Sulawesi Tengah/Lore Lindu N.P." (print), 1 ♂ (ZMA).

Etymology. — "Senilirata" is derived from the Latin words "seni", meaning "each time six of" and "lirata", meaning "ridge made by a plough". The combination stands for the fact that the species has six long ridges on the tymbal, which is characteristic, not only within the genus, but also within the Oriental Prasiini as a whole.

#### Remarks.

The species is very distinct, not only for its low number of alternating ridges on the tymbal, but also for its peculiar shaped apex of the aedeagus. As for a possible female representative of the species the reader is referred to the remarks at the end of the description of *P. sarasinorum*.

#### REFERENCES

- Ashton, H., 1912. Some new Australian Cicadidae. — Proc. R. Soc. Vict., (N.S.) 24: 221—229, pls. 49—51.
- Boulard, M., 1975. Les Plautillidae, Famille nouvelle d'Homopteres Cicadoidea. — Annali Mus. civ. Stor. nat. Giacomo Doria 80: 313—318, figs. 1—5.
- Breddin, G., 1901. Die Hemipteren von Celebes. Ein Beitrag zur Faunistik der Insel. — Abh. naturforsch. Ges. Halle 24: 1—213, pl. 1.
- Distant, W. L., 1883. Contributions to a proposed Monograph of the Homopterous Family Cicadidae. — Part 1. — Proc. zool. Soc. Lond. 1883: 187—194, pl. 25.
- Distant, W. L., 1888. Descriptions of new species of Oriental Cicadidae. — Ann. Mag. nat. Hist. (6) 2: 323—325.
- Distant, W. L., 1892. A monograph of Oriental Cicadidae, 5—7: i—xiv, 97—158, pls. 10—15. — Indian Museum, London.
- Distant, W. L., 1898. Description of two new species of Oriental Cicadidae. — Ann. Mag. nat. Hist. (7) 1: 97.
- Distant, W. L., 1905. Rhynchotal notes. — XXXV. — Ann. Mag. nat. Hist. (7) 16: 265—280.
- Distant, W. L., 1906. A synonymic catalogue of Homoptera. Part 1 Cicadidae: 1—207. — British Museum, London.
- Distant, W. L., 1909. New Malayan Rhynchota. — Trans. R. ent. Soc. Lond., 1909: 385—396, pl. 10.
- Duffels, J. P., 1977. A revision of the genus *Diceropyga* Stål, 1870 (Homoptera, Cicadidae). — Monografieën Ned. ent. Veren. 8: 1—227, figs. 1—265.
- Duffels, J. P., 1983a. Taxonomy, phylogeny and biogeography of the genus *Cosmopsaltria* Stål with remarks on the historic biogeography of the subtribe *Cosmopsaltriaria* (Homoptera, Cicadidae). — Pacif. Insects Monogr. 39: 1—127, figs. 1—135, pls. 1—6.
- Duffels, J. P., 1983b. Distribution Patterns of Oriental Cicadoidea (Homoptera) East of Wallace's Line and Plate Tectonics. In: Thornton, I.W.B. (ed.), Symposium on Distribution and Evolution of Pacific Insects, Geojournal 7 (6): 491—498.
- Duffels, J. P. & P. A. van der Laan, 1985. Catalogue of the Cicadoidea (Homoptera, Auchenorrhyncha) 1956—1980. — Series entomologica 33: i—xvi, 1—414.
- Holloway, J. D., 1979. A survey of the Lepidoptera, biogeography and ecology of New Caledonia. — Series entomologica 15: 1—xii, 1—588, figs. 1—153, pls. 1—87.



86



87



88

Figs. 86—88. General facies. 86, *Prasia faticina* ♂, paratype *P. culta*; 87, *Prasia faticina* ♀, holotype; 88, *Prasia sarasinorum* ♂, paratype Mapane surroundings.

Horvath, G., 1913. Etude morphologique sur la construction de l'élytre des Cicadas. — Int. Congr. Ent. 2: 422—432, figs. 7, 8.

Jacobi, A., 1903. Über Singcikaden von Ost-Neuguinea. — Sber. Ges. naturf. Freunde Berl. 1903: 10—15, figs. 1—5.

Jong, M. R. de, 1982. The Australian species of the genus *Lembeja* Distant, 1892 (Homoptera, Tibicini-

nidae). — Bijdr. Dierk. 52 (2): 175—185, figs. 1—23.

Jong, M. R. de & J. P. Duffels, 1981. The identity, distribution and synonymy of *Lembeja papuensis* Distant, 1897 (Homoptera, Tibicinidae). — Bull. zool. Mus. Univ. Amsterdam 8 (7): 53—62, figs. 1—12.

Karsch, F. A. F., 1890a. Beiträge zur Kenntniss der





89



90



91

Figs. 89—91. General facies. 89, *Prasia nigropercula* ♂, holotype; 90, *Prasia princeps* ♂, Minahassa; 91, *Prasia princeps* ♀, holotype.

- Singcikaden Afrika's und Madagascar's. — Berl. ent. Z. 35: 85—130, pls. 3, 4.
- Karsch, F. A. F., 1890b. Ueber die Singcicaden-gattung *Perissonoura* Distant. — Ent. Nachr. Berlin 16: 190—192.
- Kato, M., 1932. Monograph of Cicadidae: 1—450, pls. 1—32, text-figs. 1—122.
- Kato M., 1956. The biology of Cicadas: 319 p., 146 figs., 46 pl. — Iwasaki Shoten, Tokyo.
- Lallemand, V., 1931. Hemiptera-Homoptera. Résultats scientifiques du voyage aux Indes Orientales Néerlandaises de LL. AA. RR. 1e Prince et la Princesse Léopold de Belgique. — Mém. Mus. r. Hist. nat. Belg. 4: 71—85.
- Metcalf, Z. P., 1963. General catalogue of the Homoptera, VIII. Part 2. Tibicinidae: i—iv, 1—492. — North Carolina State College, Raleigh, M. C.
- Myers, J. G., 1928. The morphology of the Cicadidae (Homoptera). — Proc. zool. Soc. Lond. 1928: 365—472, figs. 1—75.
- Myers, J. G., 1929. Insect Singers. A Natural History of the Cicadas: i—xix, 1—304, figs. 1—116, pls. 1—7. — George Routledge and Sons, Ltd, London.
- Sarasin, P. & F. Sarasin, 1901. Materialien zur Naturgeschichte der Insel Celebes. Dritter Band: Ueber die geologische Geschichte der Insel Celebes auf Grund der Tierverbreitung (mit 15 Tafeln in Lithographie): i—vi, 1—169, text-figs. 1—5, pl. 1—15 figs. 1—45. — W. Kreidel's Verlag, Wiesbaden.
- Schmidt, E., 1925. Zwei neue Singcicaden von der Insel Sumba. — Societas ent. 40: 42, 43.
- Stål, C., 1862. Synonymiska och systematiska anteckningar öfver Hemiptera. — Öfvers. K. Vetensk. — Akad. Förh. 19: 479—504.
- Stål, C., 1863. Hemipterorum exoticorum generum et specierum novarum descriptiones. — Trans. R. ent. Soc. Lond. (3) 1: 571—603.
- Stål, C., 1870. Hemiptera insularum Philippinarum. — Bidrag till Philipponska öarnes Hemipter-fauna. — Öfvers. K. Vetensk.-Akad. Förh. Stockh. 27 (7): 607—776, pls. 7—9.
- Walker, F., 1858. Supplement. List of the specimens of Homopterous insects in the collection of the British Museum, 1858: 1—307.
- Walker, F., 1868. Catalogue of the Homopterous insects collected in the Indian Archipelago by Mr. A. R. Wallace, with descriptions of new species. — Proc. Linn. Soc. Lond. (Zool.) 10: 82—193, pl. 3.

---

Author's address: Institute of Taxonomic Zoology,  
P.O. Box 2015, 1000 HC Amsterdam,  
The Netherlands.









# TIJDSCHRIFT VOOR ENTOMOLOGIE

UITGEGEVEN DOOR

DE NEDERLANDSE ENTOMOLOGISCHE VERENIGING



## INHOUD

- J. C. ROSKAM. — Evolutionary patterns in gall midge — host plant associations (Diptera, cecidomyiidae), pp. 193—213, figs. 1—3.





# EVOLUTIONARY PATTERNS IN GALL MIDGE — HOST PLANT ASSOCIATIONS (DIPTERA, CECIDOMYIIDAE)

by

J. C. ROSKAM

Division of Population Biology, University of Leiden, The Netherlands

## ABSTRACT

Host plant associations of mainly West Palaearctic gall midges have been analyzed to explain some of the radiation of this highly specialized group of endophytophagous insects. Gall midges behave according to some predictions formulated for phytophagous insects in general: woody host plants accumulate more gall midge species than herbaceous ones. In other aspects gall midges seem to be different: taxonomical affinity of host plants might be more important to explain radiation in gall midges than it is for other groups of plant feeders, especially external feeders. Furthermore, gall midges deserve particular attention because the gall inducing feeding mode in this group might be a result of polyphyletical development. Specialization on host plant organs has been analyzed to support this assumption. Finally, various evolutionary processes allied with insect—host plant interactions have been analyzed for gall midges. Sequential evolution could be demonstrated in this group and some examples of apparent parallel cladogenesis, each dealing with a different rank of host plant taxonomy, are treated.

## INTRODUCTION

According to recent estimates, about 792,000 species of insects have been described, of which 46% feed upon plants (Southwood, 1978; Price, 1977). Important pioneer work on insect—host plant interactions has been done by Verschaffelt (1910), Dethier (1954) and Fraenkel (1959). The enormous expansion of literature on this subject began with the classic papers by Ehrlich & Raven (1964) on co-evolution, MacArthur & Wilson's (1967) theory of island biogeography and Janzen's (1968) application of the latter theory to insect-host plant interactions. Recent books by Crawley (1983) and Strong et al. (1984) offer a thorough introduction to the literature on this subject. Plant chemistry and, because related plant taxa often share similar compounds, plant taxonomy played an important role in earlier studies. Gradually more host plant traits became involved to explain accumulations of insect species on host plant taxa. Fowler & Lawton (1982), for example, used no less than nine variables, a potpourri of characteristics of host plants, phytophages and natural enemies of phytophages in a multiple regression calculation to explain the species richness of leafminers on British Umbelliferae. In the latter study, host plant taxonomy is not even a significant factor

anymore: 61% of the variation is explained by habitat diversity and leaf form of the host plants. In another study, however, about leafminers on British trees, 36% of the variation was caused by taxonomical diversity alone, geographic range being the second trait in importance (Godfray, 1982).

When the literature is subdivided according to the different guilds of phytophagous insects, it is remarkable that papers dealing with external plant feeders (chewing and sucking insects) are abundant, whereas references on endophytophages, such as miners and gall insects are scarce. Nevertheless it is obvious that not only among external plant feeders, but also among endophytophages there are many species with an important impact on host plant development and seed production, in natural situations (e.g., Harnett & Abrahamson, 1979), as well as in pest control (e.g., Bess & Haramoto, 1959) and in agriculture (e.g., Skuhravý et al., 1983). Furthermore, in important aspects endophytophages differ basically from external plant feeders and deserve therefore special attention. Gall insects in particular not only depend on plants for nutriment, but also for shelter, which is constructed by manipulating the defense reactions of the host plants. This very precise tuning of

the insect's needs to the plant's potentials may explain why polyphagous gall insects (species attacking host plants belonging to different families) are extremely scarce, whereas monophagous species are abundant. For this reason ecological opportunists (species shifting to new host plants which are in close proximity to, rather than taxonomically related with, the original ones) may be rare too among this group. A further consequence of the gall inducing feeding mode is that colonization of new resources by these insects, but also by miners, is a substantially slower process (Strong et al., 1984). Therefore, long term processes, playing in "evolutionary time", rather than short term processes, in "ecological" time, seem to be more apparent in interactions between host plants and gall midges.

The present study deals with host plant relations of mainly West Palaearctic gall midges. Compared with other groups of endophytophages, gall midges have some advantages. As a group, they have a broad host plant spectrum, whereas cynipids, another main group of gall insects, are abundant on Fagaceae and Rosaceae only. Agromyzids are also an important group of endophytophages, but are restricted to particular plant organs, mainly leaves.

Until now, it has been impossible to analyze host plant relations of gall midges on a world basis since the detailed knowledge needed for such a study is only available for some parts of the temperate regions. Therefore this study is restricted to data presented by Buhr (1964—1965) and Skuhřavá (in press) for the West Palaearctic, extended in some cases, where information from the Nearctic was necessary, by Felt (1940) and Gagné (1969, 1981). Whether the results will hold for other climatic areas must be considered in future.

In the next section some main characteristics will be given of the ecology and taxonomy of gall midges. Which life history traits of gall midges are important in connection to host plant relations and change of host plants? How are the Cecidomyiidae, the family gall midges belong to, subdivided and which group(s) gave rise to gall inducers? Gall midges may be unique among gall insects, because arguments exist for a polyphyletic transition of Cecidomyiidae to the gall inducing feeding mode (Mamaev, 1968). A comparison will be made for subgroups of gall midges to investigate whether specialization to different host plant organs (vegetative or gen-

erative) may contribute evidence for such a polyphyletic shift.

Subsequently, our attention will be focussed on host plant diversity. Because an analysis of evolutionary aspects is our main goal, only taxonomical and some structural diversity of host plants will be considered to explain radiation of gall midges. Taxonomically diverse plant families, including many species, are supposed to support more midge species than less diverse families, because there is more scope for adaptive radiation among phytophages in diverse taxa (Crawley, 1983). Also we will contrast woody against herbaceous host plants, because the first live longer and may be structurally more diverse, and are therefore a more predictable resource offering again more opportunities for adaptive radiation (Lawton, 1983). Other traits of host plants, such as geographical range, local abundance and habitat diversity, important ecological variables indeed, must be omitted because accurate scoring is only possible for some local areas, but not for the West Palaearctic as a whole.

Finally, knowing something about interactions between structural and taxonomical traits of host plants and gall midge diversity, questions rise about the consequences for the evolution of these phytophages. Some interactions resulted in the occurrence of related midge species on related groups of host plants. But how abundant are apparent parallel patterns in the cladogenies of gall midges and host plants and to what extent did they evolve? Are examples of parallel cladogenesis the result of plant — gall midge interaction, or were the host plants changed under influence of other selection factors and did the gall midges follow these changes? We will draw up examples of parallel cladogenesis and discuss the processes.

#### LIFE HISTORY PATTERNS

Knowledge of life history patterns is essential for evolutionary studies because each mode of speciation needs particular prerequisites of the involved organisms. Speciation processes of gall midges, which are relevant here, are those in which host plants are involved. Modes of sympatric speciation might exist when host plant shifts occur and assortative mating can be demonstrated. Partners are preferred which share the same food plant, or a highly similar food resource, during the larval phase. Therefore, mating site, oviposition site and site of larval de-



velopment have to be coupled by localization on the same host. A transfer to a new host results then not only in a new resource, but channels the gene flow by separating mating and oviposition sites of original and shifted populations (Bush, 1975; Zwölfer & Bush, 1984). On the other hand, modes of allopatric speciation may result from co-evolution, as a reciprocal process between host plants and phytophages or, when the impact of phytophages on host plant changes is doubtful or absent, sequential evolution (Jermy, 1976). Also co-evolution and sequential evolution require a highly coupled niche structure, but host plant shifts are absent. Therefore, cladogenesis of both groups of organisms is characterized by corresponding dichotomies (Regenfuss, 1978). In order to investigate which modes of speciation may occur in gall midges, relevant phases of the gall midge life history are analyzed.

Gall midges<sup>1)</sup> alternate a sedentary phase, encapsulated in a gall, with a free-living adult phase, in which dispersion is possible. The free-living phase starts with the emergence of the adults. Males usually emerge some hours earlier than females and periods of activity are species specific (Coutin & Harris, 1968; Jones et al., 1983; Skuhřavý & Skuhřavá, 1982). After a short period of rest males start swarming in search of females; usually they hover in groups in close proximity to galls where emerging females are expected. Males may mate several times (Van Vreden & Arifin, 1977). Females, like males, rest for a while after emergence. During this period the ovipositor is extended in a calling position, emitting sex pheromones (McKay & Hatchett, 1984). Attracted males copulate immediately, without any courtship behaviour. Females mate once, after mating they retract the ovipositor and are not receptive any more.

The mating, or "rendez-vous" site depends on the site where pupation occurs and, consequently, the female emerges. Before pupation, mature larvae either drop onto the soil or remain in the gall. Galls, in their turn, either may be shed from the host plant or may remain connected with it. Fertilized females disperse in search of host plants. Dispersal is mainly passive but females, as well as males, are able to fly against weak wind currents and respond to ol-

factory cues (McKay & Hatchett, 1984; Skuhřavý et al., 1983; Sylvén, 1970).

Eggs are usually laid on or close to the site where the neonate larva will penetrate the host plant. There is a considerable variation in clutch-size. The number of eggs may be one per oviposition or up to five. Some species, e.g., *Contarinia pulchripes* (Kieffer), deposit all (up to 150) eggs in one batch (Parnell, 1963). Larvae, eclosed from the same clutch, are gregarious within a gall.

Many midge species produce unisexual families, i.e., the offspring of one female are either all male or all female. This mechanism of sex regulation might be common in gall midges because the sex ratio departs in many cases from 1:1, the ratio expected in obligatory crossbreeding species. The mechanism has been studied by Metcalfe (1935) and Gallun & Hatchett (1969) for the Hessian fly, *Mayetiola destructor* (Say).

Characteristics of the host plant, such as chemical composition and phenology, may have an important impact on gall midge development and, ultimately, on fitness. Host plants that are selected for oviposition may be less suitable, or even unsuitable for larval development. Females of *Dasineura brassicae* (Winnertz), for example, prefer pods of *Brassica napus* and *B. campestris* for oviposition but also lay eggs on *B. juncea* and *B. nigra*. However, the percentage of hatched eggs on the latter pair of host species is lower and larval development less successful, resulting in females with lower egg production (Åhman, 1981 and in press). Females of *Haplodiplosis marginata* (Von Roser) search first for grasses or cereals, but if these are not available, especially during outbreaks, they will lay eggs upon any other plant and even on the soil. However, galls are only induced in grasses belonging to the tribes Triticeae and some Aveneae. Many eggs are laid upon *Avena sativa*, but there is very little survival on this species. For that reason *Avena sativa* is suggested for biological control of *Haplodiplosis* in schemes of crop rotation (Skuhřavý et al., 1983).

Another factor for successful larval development is synchronization of host plant and gall midge phenologies. Winter varieties of wheat and barley are less susceptible for *Haplodiplosis* than summer varieties because neonate larvae are unable to penetrate, at the time of attack, the more mature tissues of earlier planted varieties (Nijveldt & Hulshoff, 1968; Skuhřavý, 1982; Skuhřavý et al., 1983). Phenological synchronization is also important in other gall midge

<sup>1)</sup> Gall midges in the strict sense are gall inducers. Among Cecidomyiidae, gall midges sensu lato, some aberrant forms are predators. These are not sedentary.

pests, e.g., *Orseolia oryzae* (Wood-Mason) on rice (Van Vreden & Arifin, 1977), *Thecodiplosis brachyntera* (Schwägrichen) on pine trees (Skuhravý & Hochmut, 1969; Skuhravý, 1970). Hatchett & Gallun (1970) demonstrated a genetic basis for the ability of *Mayetiola destructor* (Say) to survive on different races of wheat. These races of wheat possess genes for resistance against attacks of *Mayetiola*, which on its turn can also be subdivided into races having genes to overcome this resistance. The gene-for-gene interaction between wheat and Hessian fly might have been developed as a reciprocal process (Gallun, 1977).

At the end of this section on life history patterns and host plant suitability we may conclude that variation in life history patterns, relevant for particular modes of speciation, is mainly present during the free-living adult phase. Sometimes a highly coupled niche structure exists indeed: if the pupation site is the gall, and the host plant is long-lived, emerged females may mate and lay eggs on the same host plant. Female dispersal is especially reduced when the eggs are laid in few (or only one) large batches (Weis et al., 1983). However, swarming of males and determination of sex by the mechanism of unisexual families considerably reduces the possibilities of assortative mating and hence sympatric speciation. Furthermore, oviposition on alien host plants occurs under some conditions, but the possibility of larval development may be a considerable hurdle for host plant shifts. Therefore, allopatric models of speciation will prevail in gall midges. Nevertheless, it is hard to imagine that in genera which exhibit extreme resource partitioning, such as the 62 *Stefaniola* species on *Haloxylon*, or the 28 *Rhopalomyia* species, distinguished by Jones et al. (1983) on *Artemisia tridentata*, have exclusively radiated according to an allopatric model of speciation.

#### TAXONOMY OF GALL MIDGES

Gall midges belong to the nematoceran family Cecidomyiidae (4,300 described species according to estimates of Skuhravý, in press). Within the suborder Nematocera the Cecidomyiidae are a distinct group: wing veins are generally weak and reduced in number, the costal vein is usually continuous around the wing and tibial spurs are absent. The larvae, usually bright yellow, orange or reddish in colour, possess a supernumerary "neck" segment between head and thorax, which allows a great mobility

of the head. On the ventral side of the prothorax a peculiar sclerotized plate, the sternal spatula, is usually present. According to Mamaev (1968) the Cecidomyiidae are closely related to the mycetophagous scavengers Sciaridae, Scaptosidae and Hyperoscelidae.

A generally adopted subdivision of the family is still lacking. Mamaev (1968), following Rübbsaamen & Hedicke (1925—1939) distinguished only two subfamilies: the Lestremiinae, with undifferentiated tarsi and with the ocelli usually present; the Cecidomyiinae with short first tarsomeres and ocelli absent. Möhn (1955), followed by many modern students of the group, proposed a third subfamily Porricondylinae. However, he was only able to separate this subfamily by larval characters concerning position and shape of the anal aperture. Mamaev, refining Rübbsaamen & Hedicke's system, differentiated the system to the subtribal rank, but many other specialists consider his system tentative and do not use it. The system used by Skuhravý (in press) in her catalogue is compared here with Mamaev's system in table 1. Further differences concerning the Cecidomyiinae deal with taxa that are difficult to place. First, the Stomatosematidi in Skuhravý's system, for example, share various archaic traits, such as wing venation (Rs well developed) and female genitalia (short, not extensile, sometimes even two-segmented cerci) with Porricondylinae, but differ from this subfamily by the male genitalia, which are reminiscent of those of Lasiopteridi. Gagné (1975), therefore, proposed an independent supertribal status for this taxon. Secondly, Gagné (1976) placed Oligotrophini and Lasiopterini in the supertribus Lasiopteridi because these tribes share derived character states of female genitalia and antennal flagellomeres; these are lacking in their sister-group Ledomyiini, which in its turn is characterized by derived conditions regarding tarsal claws and male genitalia. The relationships of *Brachineura*, *Epimyia* and *Rhizomyia*, placed in separate tribes, are still unclear. These genera are now placed in Lasiopteridi, but may be better regarded as unplaced (Gagné, 1976). Because of the still very uncertain relationships of Gagné's Stomatosematidi and Ledomyiini, we here adopt Mamaev's classification, at least as far as it concerns the tribal subdivisions.

Our special attention is focussed on host plant relations and their importance for the evolution of the gall midges. Therefore we will now analyze the phyletic relations of the tribes in

Table 1. Comparison of systems of Cecidomyiidae according to Mamaev (1968) and Skuhřavá (in press, presented with permission from the author). I, inquiline; M, mycetophagous; P, phytophagous and gall inducing; Z, zoophagous.

MAMAEV	SKUHŘAVÁ	nr. genera	nr. species	feeding mode
LESTREMIINAE 3 tribes, 7 subtribes	LESTREMIINAE 2 supertribes, 8 tribes	36	194	M
CECIDOMYIINAE	PORRICONDYLINAE			
Heteropezini	Heteropezini + Leptosynini	9	13	M
Porricondyliini	Porricondyliini + 7 more tribes	32	265	M
	CECIDOMYIINAE			
	<u>Lasiopteridi</u>			
Lasiopterini	Lasiopterini	12	150	PI Z?
6 subtribes	no subdivision			
Oligotrophini	Oligotrophini	63	600	PI
Oligotrophina + 4 more str.	Ledomyiini	1	14	MZ
Brachyneurina	Brachyneurini	5	21	M?
Rhizomyiina	Rhizomyiini	1	8	M
Epimyina	Epimyini	1	1	M?
Stomatosematina	<u>Stomatosematidi</u>	2	4	M?
Asphondyliini	<u>Asphondyliidi</u>	17	95	P
3 subtribes	4 tribes			
Cecidomyiini	<u>Cecidomyiidi</u>	109	754	GIMZ
13 subtribes	no subdivision			
	unplaced	-	140	-

connection with their feeding modes. All Cecidomyiinae share the absence of ocelli and the shortening of the first tarsal segment of legs, both derived character states. The feeding modes (table 1) in this subfamily are most diverse, ranging from mycetophagy to various forms of phytophagy and zoophagy (Mamaev, 1968). All gall inducing midges, the "true" gall midges, belong to the Cecidomyiinae. Heteropezini and Porricondyliini, with primitive wing venation (Rs usually present) and larval morphology (pattern of setae on the final two abdominal segments and location of the anal aperture), are mycetophagous, as are all Lestremiinae and all forms of the related families Sciaridae, Scatopsidae and Hyperoscelidae. Therefore, feeding on decaying organic material must be regarded as the original feeding mode of Cecidomyiidae (Southwood, 1972; Mamaev, 1968; Roskam, in press). Mycetophagy is also the feeding mode of

oligotrophine Rhizomyiina and some species of *Ledomyia*. Although the larvae of Brachineurina, Epimyina and Stomatosematina are unknown, these are expected to be mycetophagous too (Mamaev, 1968; Gagné, 1975). Furthermore larvae of the oligotrophine genus *Isogynandromyia* live in the upper layer of forest soil (Spungis, 1981).

Mycetophagy is also common in the tribe Cecidomyiini; it is the feeding mode of *Bubromyiella*, *Camptodiplosis*, *Clinodiplosis*, *Dichae-tia*, *Dichodiplosis*, *Echinella*, *Giardomyia*, *Karshomyia*, *Mycetodiplosis*, *Mycocecis*, *Mycodiplosis*, *Neoisodiplosis* and *Neomycodiplosis*, 59 species together. Some of these genera are closely related, e.g., Möhn's (1955) "*Mycodiplosis* group" and "*Clinodiplosis* group". Mamaev (1968) considered, on morphological criteria, mycetophagous Oligotrophini and Cecidomyiini primitive forms within these two tribes. No



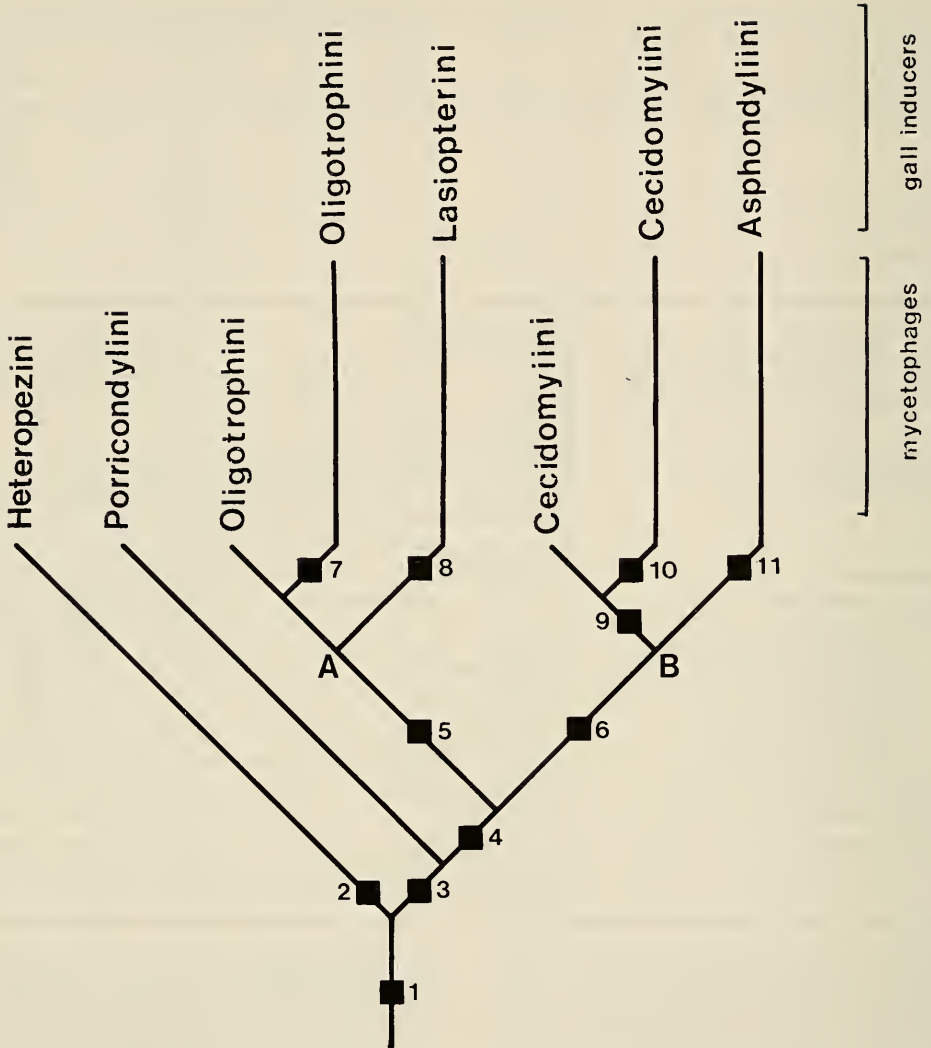

Fig. 1. Phylogenetic relations of the Cecidomyiinae tribes. Black squares indicate synapomorphic conditions. 1, ocelli absent, shortened first tarsomeres; 2, paedogenesis; 3, larval anus shifted into ventral position and slit-like; 4, reduction in number of Malpighian tubes of larval digestive tract, reduced number of dorsal and ventral papillae on the larval eighth abdominal segment; 5, substitution of parameres in male genitalia by mediobasal outgrowths of basimeres sheathing aedeagus, retractile ovipositor with fused cerci; 6, mediobasal outgrowths of male genitalia absent, number of adult antennal segments basically fixed, 2 + 12; 7, constriction in larval mid-gut shifted proximally; 8, wing vein  $R_5$  closely adjacent to  $R_1$  and  $C$ , reduced in length, antennal segments not or barely sexually dimorphic and barrel-shaped, characteristic ovipositor with hooks and spines adapted to abrade plant tissue; 9, binodal male antennal segments with looped circumfila, reduction of the eighth tergite of the female abdomen; 10, loss of the constriction in the larval mid-gut; 11, necks of antennal segments reduced in length with reticulate, closely appressed circumfila, retractile needle-like ovipositor with fused (reduced?) cerci. For further explanation see text.

mycetophagous representatives are known of Asphondyliini and Lasiopterini.

Zoophagy is mainly restricted to Cecidomyiini. Four genera are known as predators of

mites, six predate on aphids, five on coccids and two attack other cecidomyiids. Three genera are endoparasitoids of aphids and psyllids. Some of these zoophages are important agents in biolog-

Table 2. Tribal preference for vegetative (veg.) and generative (gen.) host plant tissues. Gall midges belonging to the "mixed" category attack both types of tissues. Data are from an analysis of keys on plant galls by Buhr (1964—1965), only described gall midge species included and inquilines excluded. Expected values according to "chi-square" calculation (in brackets).

	sp. nr.	veg.	gen.	mixed
<b>TRIBUS 1. LASIOPTERINI</b>				
Lasioptera	11	9	2	0
Ozirhincus	5	0	5	0
Stefaniella	2	2	0	0
3 monotypic genera	3	3	0	0
TOTAL	21	14 (13.4)	7 (6.2)	0 (1.4)
<b>TRIBUS 2. OLIGOTROPHINI</b>				
Arnoldiola	3	2	1	0
Bayeria	5	5	0	0
Cystiphora	6	6	0	0
Dasineura	110	74	33	3
Geocrypta	5	4	0	1
Iteomyia	2	2	0	0
Jaapiella	21	17	8	3
Janetia	5	5	0	0
Janetiella	6	5	0	1
Lathyromyza	2	1	1	0
Macrolabis	14	12	2	0
Mayetiola	13	13	0	0
Misopatha	5	1	1	3
Neomikiella	2	2	0	0
Oligotrophus	4	4	0	0
Physemocercis	2	2	0	0
Rabdophaga	37	36	0	1
Rhopalomyia	14	3	4	7
Wachtliella	7	4	1	2
21 monotypic genera	21	18	3	0
TOTAL	291	216 (186.3)	54 (85.7)	21 (19.0)
<b>TRIBUS 3. ASPHONDYLIINI</b>				
Asphondylia	28	6	19	3
Placocheila	2	0	2	0
Polystepha	2	2	0	0
2 monotypic genera	2	0	2	0
TOTAL	34	8 (21.8)	23 (10.0)	3 (2.2)
<b>TRIBUS 4. CECIDOMYIINI</b>				
Ametrodiplosis	5	2	3	0
Antichiridium	2	2	0	0
Contarinia	85	26	52	7
Diodaulus	2	0	2	0
Harmandia	4	4	0	0
Loewiella	2	2	0	0
Macrodiplosis	2	2	0	0
Massalongia	2	2	0	0
Planetella	13	13	0	0
Plemeliella	2	2	0	0
Thurauia	2	2	0	0
Tricholaba	4	3	1	0
18 monotypic genera	18	15	2	1
TOTAL	143	75 (91.5)	60 (42.1)	8 (9.4)

ical control. Apart from the Cecidomyiini, some species of *Trotteria* (*T. galii* Rübsaamen and *T. ligustri* Barnes), Lasiopterini, and of *Ledomyia* (*L. acariphaga* Marikovskij, *L. acerina* Giraud and *L. cardui* Kieffer), Oligotrophini, are supposed to be predators. Other forms of both genera are inquilines, and are regarded as early offshoots within their respective tribes (Mamaev, 1968; Möhn, 1966). No conclusion is possible about the origin and evolution of the zoophagous Cecidomyiini. They may have evolved polyphyletically from either mycetophagous or phytophagous ancestors. Möhn (1955) indicated three groups of related genera, namely, the *Lestodiplosis* group (e.g., *Lestodiplosis*, *Feltiella* and *Therodiplosis*, predators of gall midges, aphids and mites), the *Phaenobremia* group (e.g., *Phaenobremia*, *Aphidoletes* and *Monobremia*, on aphids) and the mutually close endoparasitoids *Endaphis* and *Endopsylla*.

A cladogram of Mamaev's tribal division of the Cecidomyiinae is presented in fig. 1. The synapomorphies (shared derived character states) 5 and 6, concerning male genitalia and antennae of both sexes, validate the two complexes of Oligotrophini-Lasiopterini and Cecidomyiini-Asphondyliini. At dichotomy A, a lasiopterine form adopted phytophagy and separated from the Oligotrophini. Then, at a further dichotomy an oligotrophine form, becoming phytophagous too, separated from the remaining mycetophagous Oligotrophini. A similar process, starting at B, subsequently gave rise to phytophagous Asphondyliini and Cecidomyiini. Hence, unless mycetophagy in Oligotrophini and Cecidomyiini is a derived feeding mode, the transition to phytophagy, culminating in gall inducing, occurred several times in a parallel way. Morphological arguments (fig. 1, the synapomorphies 7, 8, 10 and 11) as well as arguments emerging from gall midge parasitoids make a secondary transition to mycetophagy highly improbable. Mycetophagous and phytophagous cecidomyiids both have scelionid parasitoids. Chalcidoid parasitoids, however, are abundant on phytophages but do not attack mycetophages. If mycetophages have evolved from phytophages, undoubtedly some chalcidoid parasitoids would have followed their hosts and would now be present on mycetophages (Mamaev, 1968).

#### SPECIALIZATION ON HOST PLANT ORGANS

The transition from mycetophagy to phytophagy is supposed to coincide with the expan-

sion of the angiosperms during the Upper Cretaceous, about 65 million years ago (Klausnitzer, 1977; Mamaev, 1968; Zwölfer, 1978). In Upper Miocene formations, 30 million years ago, all gall midge tribes were well represented (Gagné, 1973). Two prerequisites presumably were responsible for angiosperm expansion, namely, the progressive development of the conducting system ensuring intensive movements of sap and rapid progress in the development of the flower as an adaptation to insect pollination (Takhtajan, 1954). If the earlier assertion of a polyphyletic transition to phytophagy is true, it might be reflected in different specializations of the phytophagous members of the various tribes to the different progressive developments of their host plants. In other words, some tribes might basically be adapted to exploit the conducting system of their host plants, subsequently colonizing other organs, such as leaves, whereas other tribes might be primarily adapted to generative structures, such as flowers, compact inflorescences as heads of Asteraceae and fruits.

With the help of table 2 we can investigate whether differences exist at the tribal rank in the specialization of gall midge species on tissues of their host plants. The species, compiled from Buhr (1964—1965), are subdivided into three categories: those causing deformations of vegetative structures, of generative structures and those with a "mixed" strategy, attacking both vegetative and generative structures. The data have been submitted to a chi square-test. The null hypothesis, i.e., no significant differences exist between tribes regarding specialization for organs of host plants, has to be rejected ( $\chi^2 = 54.8$ ,  $DF = 6$ ,  $P < < 0.001$ ).

The frequencies of Lasiopterini accord with the expected ones (in brackets), although the species of this tribe have ovipositors which are primarily adapted to abrade stems and to insert eggs into them. *Ozirhincus*, although sharing these morphological features, is aberrant, galling generative instead of vegetative tissues. In North America, where the Lasiopterini are well represented, most species are stem feeders since only six out of 70 species belong to the "generative" or "mixed" category (Felt, 1940; Gagné, 1969). Oligotrophini have a distinct preference for vegetative organs. Aberrant oligotrophine genera are *Gephyraululus*, *Kaltenbachiola* and *Semudobia*; aberrant species are found in most larger genera, viz., *Dasineura*, *Jaapiella*, *Macrolabis*, *Misospatha*, *Rhopalomyia* and *Wachtliel-*



Table 3. Distribution of gall midge species among orders of vascular plants. Only orders with West Palaearctic representatives have been considered and are subdivided into a fundamentally woody (+) category and a fundamentally herbaceous one (Hutchinson, 1969). The numbers of the orders refer to Takhtajan (1980), the numbers of plant species are taken from Rothmaler (1972), those of gall midge species from Buhr (1964—1965). (1) = Hutchinson's Brassicales; (2) = Hutchinson's Umbellales.

(sub)class	order	plant species	midge species	
Lycopoida	Lycopodiales	6	-	
	Selaginellales	2	-	
	Isoetales	2	-	
Sphenopoida	Equisetales	10	-	
Pteropoida	Ophioglossales	6	-	
	Osmundales	1	-	
	Polypodiales	46	2	
	Marsiliales	2	-	
	Salviniales	2	-	
Ginkgoopsida	+ Ginkgoales	1	-	
Taxopsida	+ Taxales	1	1	
Coniferopsida	+ Pinales	33	6	
Magnoliidae	5 Aristolochiales	3	-	
	7 Nymphaeales	6	-	
Ranunculidae	9 Ranunculales	81	12	
	10 Papaverales	27	1	
Hamamelidae	16 + Hamamelidales	1	-	
	18 + Urticales	15	6	
	21 + Fagales	18	40	
	24 + Myricales	1	-	
	25 + Juglandales	2	-	
Caryophyllidae	26 Caryophyllales	184	26	
	27 Polygonales	41	8	
	28 Plumbaginales	3	-	
Dilleniidae	30 + Paeoniales	2	-	
	31 + Theales	13	3	
	32 + Violales	38	7	
	34 Capparales 1)	153	17	
	35 + Tamaricales	1	-	
	36 + Salicales	34	46	
	37 + Ericales	31	5	
	39 Primulales	35	1	
	40 + Malvales	15	5	
	41 + Euphorbiales	24	7	
	42 + Thymelaeales	8	2	
	Rosidae	43 Saxifragales	61	5
		44 + Rosales	154	27
45 + Fabales		139	69	
49 + Myrtales		33	3	
50 + Rutales		6	1	
51 + Sapindales		14	7	
52 Geraniales		32	3	
53 + Polygalales		9	1	
54 + Cornales		4	1	
55 Araliales 2)		96	21	
56 + Celastrales		3	-	
57 + Santalales	9	-		
59 + Rhamnales	7	4		
Asteridae	62 Gentianales	64	17	
	63 + Oleales	6	5	
	64 Dipsacales	43	15	
	66 Polemoniales	62	9	
	67 Lamiales	90	28	
	68 Scrophulariales	163	15	
	69 Campanulales	34	7	
72 Asterales	317	70		
Alismidae	1 Alismatales	14	-	
	2 Najadales	33	-	
Liliidae	4 Liliales	89	6	
	7 Orchidales	56	-	
	9 Juncuales	42	-	
	10 Cyperales	145	18	
	15 Poales	206	29	
Arecidae	20 Typhales	9	-	
	21 Arales	8	-	
TOTALS	+ woody orders	622	246	
	herbaceous orders	2174	310	

la. Asphondyliini occur predominantly on generative structures. However, *Polystepha* is aberrant as are nine out of 28 *Asphondylia* species. The situation is rather complex in Cecidomyiini. Although almost half of the species induce galls in vegetative tissues, a substantially larger portion is predicted. *Contarinia*, by far the largest genus of Cecidomyiini, is almost completely responsible for deviations of this tribe from the expected value.

The ambiguous preference of Cecidomyiini does not allow drawing conclusions about the original specialization of the group. Two alternative ways of radiation might be possible. First, as in Oligotrophini, a phytophagous behaviour started on vegetative parts and differentiation at the generic level coincided with a shift to generative parts. The radiation of *Contarinia* has than to be regarded in connection with this shift from vegetative to generative organs. Secondly, as in Asphondyliini, the preference of *Contarinia* for generative organs should

be regarded as original. Specialists of vegetative tissues, belonging to *Contarinia* as well as to other genera, then have ancestors on generative parts. Synapomorphic conditions of male genitalia and antennae in Cecidomyiini and Asphondyliini (fig. 1: 6) support the second alternative, but a further phylogenetic study (according to current opinion *Contarinia* is not monophyletic!) is needed to solve this problem.

#### SPECIES RICHNESS AND HOST PLANT DIVERSITY

A further consequence of the assumed coincident radiation of gall midges and host plants is that these ecologically linked groups of organisms are expected to illustrate Eichler's rule (Eichler, 1948; Price, 1977): host plant taxa with many species will support more midge species than taxa which are less diverse, because there is more scope for radiation among the midges. In table 3 the accumulations of gall midge species are given for all orders of West Palearctic vascular plants. All dicotyledonous

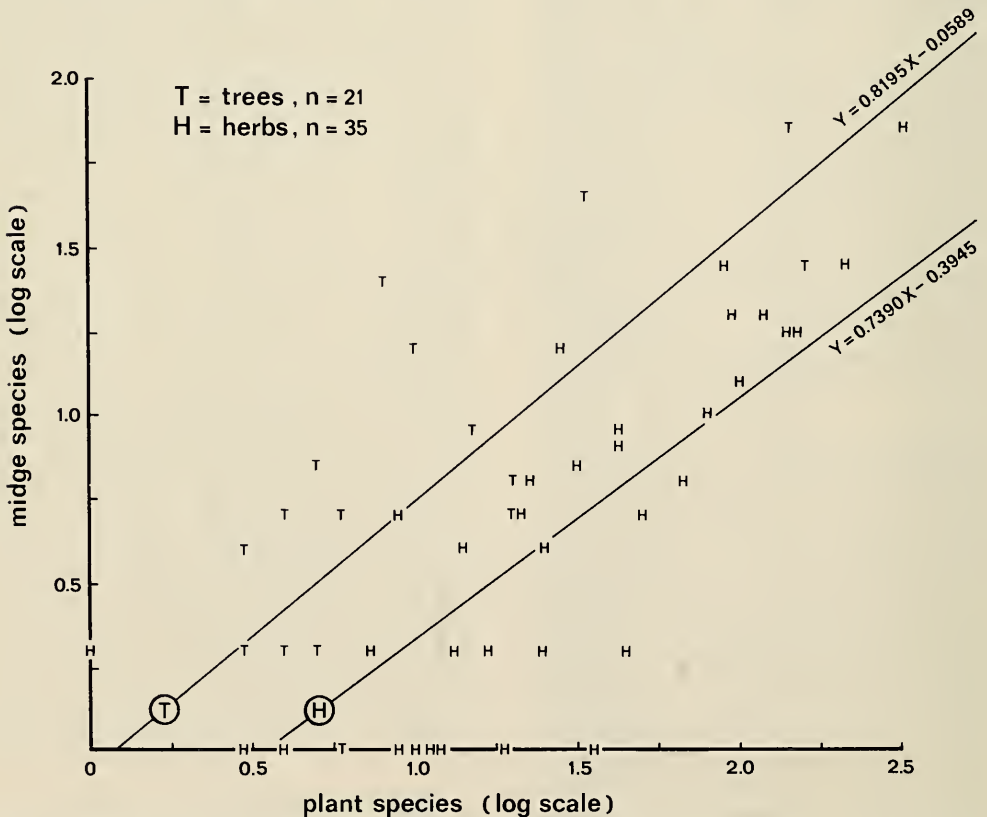

Fig. 2. Interdependence of numbers of plant and gall midge species per plant family. Midge species according to Buhr (1964—1965), plant species according to Rothmaler (1972).

orders which include ten species or more have host plants attacked by gall midges. Fagales, Salicales and Fabales (Leguminosae) in particular have host plants which shelter numerous gall midge species. Large monocotyledonous orders, such as Juncales and Orchidales, as well as most ferns and gymnosperms, lack gall midges. Poales and Cyperales, however, have many representatives with gall midges.

In fig. 2 the interdependence between the number of gall midge and host plant species per plant family is analyzed. Contrary to earlier students of insect species richness (e.g., Lawton & Price, 1979; Fowler & Lawton, 1982), we used the plant family and not the plant genus as the variate for "taxonomic diversity" (= taxonomic isolation) of host plants. This is because the present study involves many host plant families, whereas Lawton, Price and Fowler only dealt with one family, Umbelliferae. Furthermore, in different families different criteria are used to delimit genera, which makes genera unsuitable for comparison when more families are involved. For logarithmic transformed data taxonomical interdependence alone explains 52.5% ( $r = 0.72$ ) of the variation in gall midge species richness on host plants, and is therefore a very important factor. When host plants are subdivided into woody and herbaceous categories the percentages are even higher, namely, 66.1% ( $r = 0.81$ ) for woody and 63.3% ( $r = 0.80$ ) for herbaceous host plants. These high percentages mean that taxonomic diversity, reflecting diversity of host plant chemistry (Hegnauer, 1962—1973) is not the only but apparently a major factor determining accumulation of gall midge species on host plants. Similar suggestions were made by Claridge & Wilson (1981), dealing with mesophyll-feeding leafhoppers. Price (1977) observed a similar interdependence for another group of endophytophages: Agromyzidae. In his calculation 50.4% of the variation of leafminer species per host plant family was explained by the number of plant species in that family ( $r = 0.71$ ).

The regression lines for woody and herbaceous host plants do not differ significantly by slope, only by intercept. Hence, gall midge species are more numerous in plant families with woody representatives than in those with herbaceous ones: the "high apparency" of long-lived woody host plants (Fox, 1981; Lawton, 1983; Lawton & Schröder, 1977; Klausnitzer, 1977) also works positively out for gall midges.

When the gall midges are subdivided into

Table 4. Tribal preference with respect to the life form of host plants. Data after an analysis of the keys by Buhr (1964—1965).

	species number	percentage of life form		
		annual/biennial	perennial herbs	shrubs/trees
Lasiopterini	21	28.6	52.4	19.0
Oligotrophini	291	8.9	54.3	36.8
Asphondyliini	34	7.9	63.3	28.9
Cecidomyiini	143	4.7	61.7	33.6

tribes and host plants categories according to their life form (table 4), most gall midges of all tribes occur on perennial herbs, whereas short-lived herbs are poorly represented. The high score of Lasiopterini for short-lived herbs is mainly caused by one species, *Lasioptera carophila* F. Loew, which attacks many short-lived umbellifers. When analyzing the life form preference of Lasiopterini for North America, where *L. carophila* is absent (compilation of Felt, 1940, and Gagné, 1969), 7.1% of 70 species occur on annual and biennial host plants, 67.1% on perennial herbs and 25.7% on shrubs and trees, values conforming to those of tribes other than Lasiopterini in Europe.

The short-lived host plants need a further analysis. Many of these plants are characterized by conspicuous chemicals as furanocoumarins (Apiaceae) or mustard oil glucosides (Brassicaceae). Short-lived Apiaceae are hosts for two polyphagous species, viz., *Lasioptera carophila* F. Loew and *Kiefferia pimpinellae* (F. Loew). Short-lived Brassicaceae harbour polyphagous *Contarinia nasturtii* (Kieffer), *Dasineura brassicae* (Winnertz) and *D. sisymbrii* (Schrank) and *Gephyraulus raphanistri* (Kieffer). *Mayetiola destructor* (Say), *Haplodiplosis marginata* (Von Roser) and *Hybolasioptera cerealis* (Lindeman) have many annual cereals in their host ranges. These cereals occur in high densities, in "flocks", and germinate not far from the place where the previous generation lived. In this way they are "predictable" resources and resemble perennials. Finally, short-lived host plants are present among Chenopodiaceae (*Haloxylon*), Asteraceae (e.g., *Senecio*, *Sonchus*, *Cirsium* and *Carduus*) and Leguminosae (e.g., *Lathyrus*,



*Lens*, *Medicago*, *Melilotus*, *Pisum* and *Vicia*). These host plants either occur under natural conditions in dense populations, or are also cultivated.

#### PARALLEL PATTERNS IN GALL MIDGE AND HOST PLANT EVOLUTION

If related parasites live on related hosts, allopatric speciation patterns in both groups of organisms may have evolved along parallel lines: dichotomies in host cladograms then have corresponding dichotomies in cladograms of parasites. Corresponding dichotomies or cladogeneses may be the result of a reciprocal process between hosts and parasites: parasite attack, reducing fitness of the host, provokes the host to develop defense or avoiding mechanisms. Parasites, on their turn, try to overcome host defenses by counter adaptations and so on. However, long term reciprocal interactions (defined by Janzen (1980) as co-evolution) are not the only process resulting in parallel patterns. Moreover, when they do so, they may be difficult to measure. Parasites usually share their host plants with many other parasites, each possessing different trophic links with their hosts (Klausnitzer, 1977). A change of a host, to avoid one parasite, might be advantageous for another. The complexity of interactions reduces the profits of that change (Fox, 1981). Changes in the host plant may also, and more frequently, be the result of responses to abiotic changes of the host plant habitat. Parasites may follow the changes of their hosts for their own benefit. This type of parallel evolution has been defined by Jermy (1976) as sequential evolution. Finally, speciation processes in host plants and parasites may coincide, but as independent responses to the same abiotic factor. Vicariance, caused by the same geographic isolation in subgroups of hosts and parasites, may so cause a parallel pattern in the phylogenies of both groups (e.g., Roskam, 1979).

Parallel patterns need not necessarily be strict because phytophages, unlike many parasites of vertebrates, have a free phase during their life-cycle. While dispersion of vertebrate parasites usually occurs by conspecific contacts of their hosts, dispersion of phytophages, at least in gall midges is possible during a free-living phase, as was reported in the above. They may shift to other, usually related, host species during that phase, causing disturbances of parallel patterns (Regenfuss, 1978).

Whereas the host range of zoophagous and

saprophagous cecidomyiids is relatively wide (Nijveldt, 1969; Skuhravá, 1973), most gall inducing and inquiline species have only narrow host plant ranges. They usually attack some related species belonging to the same genus, or species belonging to closely related genera. Exceptions are, e.g., *Lasioptera carophila* F. Loew and *Kiefferia pimpinellae* (F. Loew) on Apiaceae; *Dasineura sisymbrii* (Schrank), *D. brassicae* (Winnertz) and *Gephyraulius raphanistri* (Kieffer) on Brassicaceae. Both host plant families are distinct by chemical compounds, furanocoumarins and mustard oil glucosides, respectively. Some *Asphondylia* species alternate host plants during their life-cycle, as do aphids. According to Orphanides (1975), the winter generation of the carob gall midge, *Asphondylia* sp., induces galls in pods of carobs, *Ceratonia siliqua*. Summer generations, however, attack various, not related, plant species, viz., *Capsicum* and *Solanum* (Solanaceae), *Capparis* (Capparidaceae), *Eruca* and *Sinapis* (Brassicaceae), *Hypericum* (Hypericaceae), *Verbascum* (Scrophulariaceae), *Sesamum* (Pedaliaceae) and even monocots, viz., *Urginea* and *Asphodelus* (Liliaceae). It is still uncertain whether midges reared from these plants will be conspecific. Some, however, certainly are. A similar situation seems to exist in the soybean gall midge, *Asphondylia* sp., overwintering in soybean pods but with unknown summer hosts (Yukawa et al., 1983).

Among gall midge genera large differences exist regarding the breadth of their host plant spectrum. In table 5 gall inducing midge genera are subdivided into three categories, namely, monophagous, oligophagous and polyphagous genera. Genera with eight species or more are listed, whereas smaller genera only are indicated by their number of species. The large genera *Dasineura*, *Contarinia*, *Jaapiella* and *Macrolabis*, but also the smaller *Wachtliella*, are presented in brackets, because they are highly artificial and therefore do not allow conclusions about the affinities of their host plants. Interdependence between gall midge species diversity and breadth of the host plant spectrum seems to be absent: not only large genera as *Asphondylia*, *Rhopalomyia* and *Lasioptera* are polyphagous, but also many small genera consist of species which occur on host plants belonging to different families. Monotypic polyphagous genera are absent.

*Lasioptera* and *Neolasioptera* are two large genera which are thought to be natural. Gagné

Table 5. Host plant spectrum of gall midge genera. M, monophagous genera, all host plants belong to only one genus; O, oligophagous genera, host plants belong to one family; P, polyphagous genera, host plants belonging to several families. Data from Skuhrová (in press, with permission from the author). For further explanation, see text.

genus	nr. of species	M	O	P
<i>Dasineura</i>	257			(1)
<i>Contarinia</i>	151			(1)
<i>Stefaniola</i>	69	1		
<i>Asphondylia</i>	54			1
<i>Rhopalomyia</i>	49			1
<i>Lasioptera</i>	45			1
<i>Rabdophaga</i>	38		1	
<i>Halodiplosis</i>	37		1	
<i>Jaapiella</i>	31			(1)
<i>Macrolabis</i>	31			(1)
<i>Planetella</i>	26	1		
<i>Mayetiola</i>	25		1	
<i>Baldratia</i>	23		1	
<i>Janetiella</i>	15			1
<i>Ametrodiplosis</i>	13			1
<i>Oligotrophus</i>	10			1
<i>Arnoldiola</i>	8	1		
<i>Wachtliella</i>	8			(1)
2 genera	7	1		1
4 genera	6	2	2	
5 genera	5	1	1	3
3 genera	4	2	1	
15 genera	3	8	4	3
18 genera	2	7	2	9
total natural genera with more than one species		24	14	22
71 genera	1	68	3	

(1969) revised the Nearctic species, of which Felt (1940) presented the host plants. Both genera are well represented on host plants belonging to the subclasses Rosidae (orders: Rosales, Fabales, Cornales and Rhamnales) and Asteridae (orders: Lamiales, Scrophulariales and Asterales). They are absent from Monocotyledonae; two species of *Lasioptera* occur on *Ephedra* (Gymnospermae, Gnetales). *Lasioptera* has five species on host plants of the subclass Hamamelidae (*Humulus* and *Quercus*), from which subclass *Neolasioptera* is absent. On the other hand, *Neolasioptera* is represented in the subclasses Magnoliidae (Lauraceae: *Benzoin*) and Ranunculidae (Ranunculaceae: *Clematis*) where *Lasioptera* is absent. Although both genera have accumulations of species on Rosidae and Asteridae, apparent parallel patterns with the phylo-

geny of host plants belonging to these subclasses are still lacking.

Some smaller genera also have species attacking hosts belonging to unrelated families or even have species with a non-cecidogenic feeding mode. *Janetiella*, for example, occurs on hosts belonging to Pinaceae, Cupressaceae, Fagaceae, Ulmaceae, Chenopodiaceae, Brassicaceae, Leguminosae, Vitaceae, Euphorbiaceae, Labiatae and Asteraceae. Host plants of *Ametrodiplosis* belong to ten families; two species are inquilines. Even among genera with only two included species, nine occur on host plants which are taxonomically distant. *Physemocelis hartigi* (Liebel) causes galls on *Tilia* (Tiliaceae), whereas *P. ulmi* (Kieffer) occurs on *Ulmus* (Ulmaceae). *Antichiridium caricis* Kieffer and *A. striatum* (Rübsaamen) cause galls on *Carex* (Cype-

raceae) and *Molinia* (Poaceae), respectively. *Pleimiella abietina* Seitner and *P. betulicola* (Kieffer) have *Abies* (Pinaceae) and *Betula* (Betulaceae), respectively, as host plants. These genera may involve examples of ecological opportunists because the host plants on which their species occur share the same habitat. Other genera with two species, however, occur on host plants which have neither taxonomical, nor apparent ecological connections, e.g., *Dicthyomyia navasiana* Tavares and *D. salsolae* Tavares on *Santolina* (Asteraceae) and *Salsola* (Chenopodiaceae), *Schizomyia galiorum* Kieffer and *S. tami* Kieffer on *Galium* (Rubiaceae) and *Tamus* (Dioscoreaceae).

On the other hand, some larger genera radiated on closely related host plants. *Stefaniola* and *Planetella* have host plants belonging to only one genus, *Haloxylon* and *Carex*, respectively. *Rabdophaga* occurs on Salicaceae (mainly on *Salix*) and *Mayetiola* on grasses. *Baldratia* and *Halodiplosis* exclusively occur on Chenopodiaceae. When apparently monophyletic genera are taken together no less than 63% (38 out of 60 genera) radiated on host plants which are taxonomically close.

Examples of parallel cladogenesis in gall midges and host plants will primarily be found in genera that radiated on taxonomically related host plants. In the next paragraph of this section some of these examples will be treated. The examples are arranged according to the taxonomical rank of the host plants at which the radiation occurred.

#### A. Host plant family

Host plants of *Asphondylia* mainly belong to two families which are phylogenetically distant, namely, Leguminosae and Labiatae. Correlated with the taxonomic position of the host plants there is a specialization with respect to the host plant tissue. Out of 28 species mentioned in Buhr (1964—1965), all species on Labiatae (6) make flower galls, whereas 18 species on Leguminosae are specialized on pods (11) or vegetative parts (6); *A. sarothamni* H. Loew on *Sarothamnus* causes galls in pods, flowers and shoots. Hence, species causing flower galls on Labiatae and fruit galls (and later in evolutionary time, shoot galls?) on Leguminosae may represent two different evolutionary lines in this polyphagous genus.

Three genera, *Mayetiola* (Oligotrophini), *Haplodiplosis* (Cecidomyiini) and *Hybolasioptera* (Lasiopterini), of which the latter two are

monotypic, induce galls in culms and shoots of Poaceae. As a rule, they attack many wild grasses. Some species, however, are extremely important pests of cereals. *Mayetiola destructor* (Say), the Hessian fly, is the most important gall midge species damaging cereals. Wild grasses from which the species has been reported belong to *Cynodon* (Poaceae-Eragrostidae), *Phleum*, *Aegilops*, and *Agropyron* (Poideae). Other *Mayetiola* species, usually one per plant genus, induce galls in culms and shoots of *Avena*, *Brachypodium*, *Calamagrostis* (various *Mayetiola* species occur in this genus), *Dactylus*, *Holcus*, *Molinia*, *Phalaris*, *Poa* and *Secale* (all Pooideae). *Giraudiella*, one species, closely related to *Mayetiola*, induces galls on *Phragmites* (Pooideae). Hence, most host plants belong to the subfamily Pooideae, but at a lower level apparent patterns are absent.

#### B. Host plant tribe

Four clusters of oligophagous genera, restricted to Asteraceae, are of particular interest with respect to parallel cladogenesis (table 6). All five species of *Ozirhincus* (Lasiopterini) induce fruit galls in host plants belonging to Asteroideae-Anthemidae, as does *Lasioptera* (*Pro-lasioptera niveocincta* (Kieffer)). The Nearctic genus *Asteromyia* (Lasiopterini), with 20 species, only induces galls in members of the tribe Asteraceae. Two related Oligotrophini genera, namely, *Rhopalomyia* (49 spp.), of which 14 are mentioned in Buhr, and *Misospatha* (5 spp.), are present in Anthemidae too. *Cystiphora* (6 spp.), which also belongs to the Oligotrophini, only causes galls in members of the subfamily Cichorioideae. In *Cystiphora*, there is host specificity below the genus level: *C. hieracii* (F. Löw) and *C. pilosellae* Kieffer are restricted to the *Archieracium* and *Pilosella* groups of species, respectively. In Asteroideae-Cardueae both species of *Loewiola* (Cecidomyiini) induce leaf galls in *Centaurea* and *Serratula*, whereas *Acodiplosis* (1 sp.), close to *Loewiola*, is present on *Inula* (Inuleae). We may conclude that, contrary to gall midges occurring on grasses, midge genera on Asteraceae exhibit specificity at the tribal rank.

#### C. Host plant genus

Many gall midge genera are restricted to only one host plant genus. Sometimes, related midge genera have related host plants. *Dryomyia*, for example, with four species, is reported from leaves of *Quercus*, whereas its relative, *Hartiogiola*, with one species, causes galls in leaves of



Table 6. Gall midge genera associated with Asteraceae. Subdivision of Asteraceae according to Engler (1964).

subfamily	tribe	genus	Cecido- myiini	Oligo- trophini	Lasio- pterini	
			Loewiola Acodiplosis	Rhopalomyia Misospatha Cystiphora	Ozирhincus L. (Prolasioptera) Asteromyia	
Asteroideae	Eupatorieae	-				
	Senecioneae	-				
	Calenduleae	-				
	Anthemideae	Anthemis			+	
		Achillea		+	+	+
		Matricaria		+	+	+
		Chrysanthemum		+	+	
		Tanacetum		+	+	
		Artemisia		+	+	
		Astereae	Erigeron			+
	Aster					+
	Solidago					+
	Bigelowia					+
	Inuleae		Inula		+	
		Cynareae	Serratula	+		
Centaurea	+					
Cichorioideae	Cichorieae	Hypochoeris		+		
		Leontodon		+		
		Scorzonera		+		
		Chondrilla		+		
		Taraxacum		+		
		Sonchus		+		
		Crepis		+		
		Hieracium		+		

*Fagus. Semudobia*, with three Palaearctic species, occurs on *Betula*, whereas its relative *Mikomyia*, with one species, causes galls in *Corylus*. Within this category three examples have been selected, viz., *Rabdophaga* (Oligotrophini), with 38 species on *Salix*, *Planetella* (Cecidomyiini), with 26 species on *Carex*, and *Semudobia* (Oligotrophini) in fruit catkins of *Betula*.

One species of *Rabdophaga* is known from twigs of *Populus*, the other species cause galls in shoots, twigs and catkins of *Salix*. Within *Salix*, there seem to be three levels of specialization that coincide with the division of *Salix* into subgenera. Infections are absent from the subgenus *Chaematia* Dumortier, all prostrate, small shrubs. Some *Rabdophaga* species occur in both remaining subgenera: *Salix* s.s. (trees and large shrubs) and *Caprisalix* Dumortier (shrubs). *R. terminalis* Kieffer, for instance, occurs in shoots and leaves, *R. rosaria* (H. Loew) in shoots, *R. deletrix* (Rübsaamen) in buds and *R. nervorum* (Kieffer) in leaves. However, a number of species exclusively attack willows of the subgenus *Salix*: *R. saliciperda* (Dufour) in twigs, *R. triandraperda* Barnes in twigs, *R. heterobia* (H. Loew) in shoots and in male catkins. The majority of *Rabdophaga* species are restricted to the large genus *Caprisalix*.

Table 7 presents the host plant relations of 13 *Planetella* species which are recorded in Buhr (1964—1965). Two groups of species are distinct, namely, the species which cause galls in sedges belonging to both sections *Vignea* (Beauvois) Kükenthal and *Carex*, and those which are restricted to the section *Carex*. Records are absent from the remaining subgenera *Indocarex* Baillon and *Primocarex* Kükenthal. When analyzing Rübsaamen & Hedicke's (1925—1939) keys, there is a parallel situation in gall midges and host plants with respect to the state of derivativeness of some characters: the species which exhibit apomorphic character states in the shape of the adult thorax and/or number of male flagellomeres, viz., *Planetella tarda* (Rübsaamen), *rosenhaueri* (Rübsaamen), *fischeri* (Frauenfeld), *tumorifica* (Rübsaamen) and *cornifex* (Kieffer), only occur on sedges which in their turn share synapomorphies with respect to the differentiation of their inflorescences in male and female spikes. Unfortunately, the two poorly known species *P. kneuckeri* (Kieffer) and *P. subterranea* (Kieffer & Trotter), which were only reported from sedges belonging to the section *Vignea*, are not mentioned in Rübsaamen & Hedicke.

Table 7. Species of *Planetella* associated with subgenera of *Carex*. Subdivision of *Carex* according to Chater (1980).

	Vignea	Carex
<i>caricis</i>	+	+
<i>baudisi</i>	+	+
<i>granifex</i>	+	+
<i>arenaria</i>	+	+
<i>subterranea</i>	+	-
<i>gallarum</i>	+	+
<i>frireni</i>	+	+
<i>kneuckeri</i>	+	-
<i>tarda</i>	-	+
<i>cornifex</i>	-	+
<i>rosenhaueri</i>	-	+
<i>fischeri</i>	-	+
<i>tumorificus</i>	-	+

Cladograms of gall midges and host plants have been provided by Roskam (1979) for *Semudobia* (five spp.), including two Nearctic species, and *Betula* (about 40 spp.) (fig. 3). Four dichotomies, or events of speciation, in *Semudobia* have corresponding branchings in *Betula*. First, *S. skuhravae* Roskam induces galls in the bracts of fruit catkins, whereas *S. betulae* (Winertz), *S. tarda* Roskam, *S. brevivalpis* Roskam and *S. steenisi* Roskam, sharing apomorphies of larval and adult morphology, make galls in fruits. This dichotomy 1 is reflected in *Betula* at the section level. Whereas birches belonging to the sections *Costatae* (Regel) and *Humiles* (Koch) have erect catkins with fruits overwintering in the trees, birches of the sections *Excelsae* (Koch) and *Acuminatae* (Regel) bear pendent catkins and disperse their fruits in the autumn of the year of flowering, an apomorphic condition. Acuminate birches lack *Semudobia* galls. *S. skuhravae* causes galls in birches of all remaining sections, but the fruit galling midges are only present on birches of the section *Excelsae*. The structure of the catkins in the latter

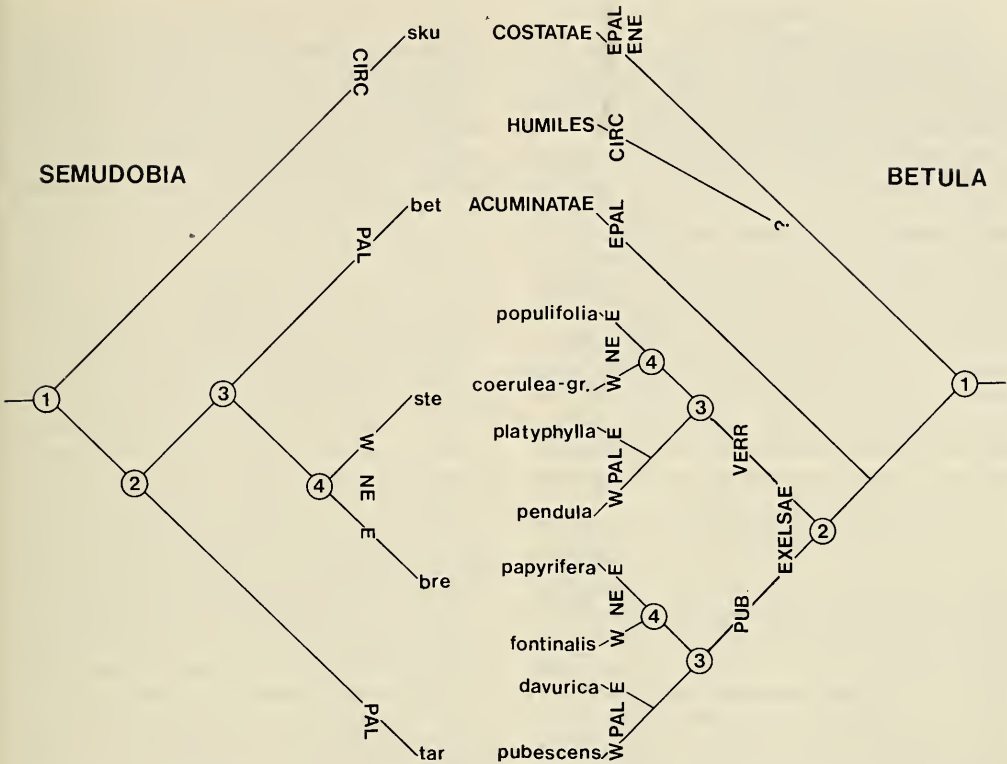

Fig. 3. Parallel cladogenesis in *Betula* and *Semudobia*. The numbers refer to corresponding dichotomies in the cladograms. The branch which is not supported by apomorphies is indicated by a question mark. CIRC, Circumboreal; NE, Nearctic; PAL, Palaeartic; PUB, *Pubescentes*; VERR, *Verrucosae*; bet, *Semudobia betulae*; bre, *S. brevivalpis*; sku, *S. skubraevae*; ste, *S. steenisi*; tar, *S. tarda*.

section allows fruit galling *Semudobia* species to hibernate in the soil, which is a favourable condition (Möhn, 1961).

Dichotomy 2 in *Semudobia* is paralleled by *Betula* at the series level: *S. tarda* is common in birches of the series *Pubescentes* Sukaczew of *Excelsae*, whereas *S. betulae* predominates in birches belonging to the series *Verrucosae* Sukaczew. This branching separates birches of different habitat conditions and apparently evolved under allopatric conditions. However, the recent birches of both series may occur sympatrically, as do *S. betulae* and *S. tarda*. Both midge species are able to induce galls in birches belonging to both series, but their preference is different, reminiscent to the original, allopatric situation (Roskam & Van Uffelen, 1981).

Finally, there is a correspondence regarding the third and fourth branchings, as a result of geographical vicariance. In both series of the section *Excelsae* different species occur in the

western and eastern part of both Palaeartic and Nearctic. In the "betulae group" of *Semudobia* species, viz., *S. betulae*, *S. brevivalpis* and *S. steenisi*, this vicariance is incompletely paralleled: *S. brevivalpis* and *S. steenisi* being restricted to the East and West Nearctic, respectively, and *S. betulae* occurring in the whole Palaeartic (Roskam, 1979).

We must conclude, as was expected in phytophages, that parallel branchings in *Betula* and *Semudobia* are not complete. Moreover, fruit-galling *Semudobia* species were able to shift to other phyletic lines of birches under circumstances of secondary sympatry. Real reciprocal adaptations are absent. The first dichotomy is an example of sequential evolution: a change in the construction of the catkin, in favour of dispersal of the birch fruits, is exploited by the fruit-galling midges to improve their conditions for hibernation. All other branchings evolved simultaneously in plants and midges under conditions of allopatry.



## CONCLUSIONS

1. Two feeding modes are common in Cecidomyiidae, namely mycetophagy and phytophagy, the latter eventually culminating in gall induction. Phytophagy, occurring exclusively in Cecidomyiinae, must be considered as a derived feeding mode. Outgroup comparison of larval and adult morphology, and feeding modes of related nematoceran families are arguments for this conclusion. Within the Cecidomyiinae two clusters of tribes can be defined on morphological synapomorphies, viz., Oligotrophini — Lasiopterini and Cecidomyiini — Asphondyliini. Because in both clusters mycetophagous representatives exist, and a secondary transition from phytophagy to mycetophagy is highly improbable, an independent, and hence polyphyletic transition from mycetophagy to phytophagy must be accepted in gall midges.

2. When species richness of gall midges is defined for families of host plants (logarithmically transformed data), the taxonomic interdependence of gall midge and host plant species numbers explains more than half the variation of gall midge species richness on those plants. Long-lived, woody plants accumulate more gall midge species than short-lived herbs. Contrary to some results for external plant feeders, taxonomical diversity of host plants is an important variate for this group of endophytophages to explain their radiation.

3. At the tribal rank gall inducing Cecidomyiidae are differently adapted to structures of their host plants. In Lasiopterini and Oligotrophini significantly more species are adapted to vegetative organs, such as stems, vegetative shoots and leaves, whereas in Asphondyliini and Cecidomyiini more species are adapted to generative organs, such as flowers, inflorescences and fruits. If the preference for generative tissues in *Contarinia* is original for Cecidomyiini, the different preference of gall midge tribes for host plant organs may function as evidence for a polyphyletic transition to phytophagy.

4. Most gall inducing midge species have narrow host plant spectra. Limits at the gall midge genus level are usually narrow too: species of the same genus have host plants which are also congeneric or belong to some closely related genera. Although examples of ecological opportunists are in the minority, they also exist in gall midges. Gall midge — host plant relations may

be diffuse: parallel traits between gall midge and host plant phylogenies are absent, due to shifts of gall midges to, usually, related host species during the free living adult phase. Sometimes remarkable parallel traits are present in gall midge and host plant phylogenies. Dichotomies at the species level in gall midges match dichotomies at various levels of host plant taxonomy. In *Asphondylia* a dichotomy is present at the host plant family level: one cluster of species causes galls in flowers of Labiatae, whereas another cluster is restricted to pods or vegetative parts of Leguminosae. *Loewiola* and *Acodiplosis*, two closely related Cecidomyiini, both occur on Asteraceae, but have host plants belonging to the different, also mutually close tribes Cynareae and Inuleae, respectively. In *Rabdophaga* and *Planetella* specificity is present below the genus level of host plants. Species of the latter genus, which exhibit morphological synapomorphous character stages occur on sedges which in their turn are also characterized by synapomorphies, indicating parallel evolution of both groups. In *Semudobia* parallel traits with host plant phylogeny are obvious. Some corresponding dichotomies evolved independently in both systems as a result of geographical isolation, one event of parallel cladogenesis apparently is the result of sequential evolution.

5. Prerequisites for sympatric speciation are present in gall midges which live in perennial plants, hibernating and pupating in the galls; mating and oviposition then occurs in close proximity to the gall. However, assortative mating, another prerequisite, is unlikely in many instances because of the production of unisexual families by females and swarming flights of virgin males. Furthermore, in cases of host shifts, even to closely related plant taxa, a considerable reduction of fitness can be observed. Nevertheless, analysis of life-history traits offers a few examples in which gall midges possess a niche structure appropriate for sympatric speciation, e.g., Nearctic *Rhopalomyia* species on *Artemisia*.

Finally, we must be aware that in a group of phytophages, where so many related taxa share related host plants, many more parallel events will be discovered. Only when monographic work is combined with a detailed study of host plant relations, the major processes responsible for the present gall midge diversity will become understood.

## ACKNOWLEDGEMENTS

I am very grateful to Dr R. J. Gagné (Washington, D.C.), Dr K. M. Harris (London) and Professor Dr H. Zwölfer (Bayreuth) for their profound criticism of earlier drafts of the manuscript. Stans Kofman compiled many of the data and Dr M. Zandee (Leiden) helped with the statistics.

## REFERENCES

- Åhman, I., 1981. Några kålväxternas potential som värdväxter för skidgallmyggan. — Ent. Tidskr. 102: 111—119 (Swedish with English summary).
- Åhman, I., in press. Larval feeding period and growth of *Dasineura brassicae* Winn. (Dipt., Cecidomyiidae) on *Brassica* host plants. — Oikos.
- Bess, H. A. & F. H. Haramoto, 1959. Biological control of pamakani, *Eupatorium adenophorum*, in Hawaii by a tephritid gall fly, *Procecidochares utilis*. 2. Population studies of the weed, the fly, and the parasites of the fly. — Ecology 40: 244—249.
- Buhr, H., 1964—1965. Bestimmungstabellen der Gallen (Zoo- und Phytocecidien) an Pflanzen Mittel- und Nordeuropas. — Fischer, Jena.
- Bush, G. L., 1975. Sympatric speciation in phytophagous parasitic insects. — In: Evolutionary strategies of parasitic insects and mites, by P. W. Price (ed.), pp. 187—206. — Plenum, New York.
- Chater, A. O., 1980. *Carex*. — In: Flora Europaea 5, by T. G. Tutin, V. H. Heywood, N. A. Burges, D. M. Moore, D. H. Valentine, S. M. Walters and D. A. Webb (eds.), pp. 290—323. — Cambridge University Press, Cambridge.
- Claridge, M. F. & M. R. Wilson, 1981. Host plant associations, diversity and species-area relationships of mesophyll-feeding leafhoppers of trees and shrubs in Britain. — Ecol. Entomol. 6: 217—238.
- Coutin, R. & K. M. Harris, 1968. The taxonomy, distribution, biology and economic importance of the millet grain midge, *Geromyia penniseti* (Felt), gen.n., comb.n. (Dipt., Cecidomyiidae). — Bull. ent. Res. 59: 259—273.
- Crawley, M., 1983. Herbivory: the dynamics of animal-plant interaction. — Blackwell, Oxford.
- Dethier, V. G., 1954. Evolution of feeding preferences in phytophagous insects. — Evolution 8: 33—54.
- Ehrlich, P. R. & P. H. Raven, 1964. Butterflies and plants: a study in coevolution. — Evolution 18: 586—608.
- Eichler, W., 1948. Some rules in ectoparasitism. — Ann. Mag. Nat. Hist. Ser. 12 (1): 588—598.
- Engler, A., 1964. Syllabus der Pflanzenfamilien, 2nd part. — Borntraeger, Berlin.
- Felt, E. P., 1940. Plant galls and gall makers. — Hafner, New York.
- Fowler, S. V. & J. H. Lawton, 1982. The effects of host-plant distribution and local abundance on the species richness of agromyzid flies attacking British umbellifers. — Ecol. Entomol. 7: 257—265.
- Fox, L. R., 1981. Defense and dynamics in plant herbivore systems. — Amer. Zool. 21: 853—864.
- Fraenkel, G., 1959. The raison d'être of secondary plant substances. — Science 129: 1466—1470.
- Gagné, R. J., 1969. A tribal and generic revision of the Nearctic Lasiopteridi (Diptera: Cecidomyiidae). — Ann. Ent. Soc. Am. 62: 1348—1364.
- Gagné, R. J., 1973. Cecidomyiidae from Mexican tertiary amber (Diptera). — Proc. Ent. Soc. Wash. 75: 169—171.
- Gagné, R. J., 1975. A revision of the Nearctic Stomaosematidi (Diptera: Cecidomyiidae: Cecidomyiinae). — Ann. Ent. Soc. Amer. 68: 86—90.
- Gagné, R. J., 1976. New Nearctic records and taxonomic changes in the Cecidomyiidae (Diptera). — Ann. Ent. Soc. Amer. 69: 26—28.
- Gagné, R. J., 1981. Cecidomyiidae. — In: Manual of Nearctic Diptera. 1, by J. F. McAlpine, B. V. Peterson, G. E. Shewell, H. J. Teskey, J. R. Vockeroth and D. M. Wood (eds.) pp. 257—292. — Research Branch Agriculture Canada Monograph No. 27, Ottawa.
- Gallun, R. L., 1977. Genetic basis of Hessian fly epidemics. — Ann. New York Acad. Sci. 287: 223—229.
- Gallun, R. L. & J. H. Hatchett, 1969. Genetic evidence of elimination of chromosomes in the Hessian fly. — Ann. Ent. Soc. Amer. 62: 1095—1101.
- Godfray, H. C. J., 1982. Leaf miners and their parasites in relation to succession. — Unpublished PhD Thesis, University of London.
- Harnett, D. C. & W. G. Abrahamson, 1979. The effects of stem gall insects on life history patterns in *Solidago canadensis*. — Ecology 60: 910—917.
- Hatchett, J. H. & R. L. Gallun, 1970. Genetics of the ability of the Hessian fly, *Mayetiola destructor*, to survive on wheats having different genes for resistance. — Ann. Ent. Soc. Amer. 63: 1400—1407.
- Hegnauer, R., 1962—1973. Chemotaxonomie der Pflanzen. I—VI. — Birkhäuser, Basel.
- Hutchinson, J., 1969. Evolution and phylogeny of flowering plants. Dicotyledons: facts and theory. — Academic Press, London.
- Janzen, D. H., 1968. Host plants as islands in evolutionary and contemporary time. — Amer. Nat. 102: 592—595.
- Janzen, D. H., 1980. When is it coevolution? — Evolution 34: 611—612.
- Jermyn, T., 1976. Insect-host plant relationship: coevolution or sequential evolution? — Symp. Biol. Hung. 16: 109—113.
- Jones, R. G., R. J. Gagné & W. F. Barr, 1983. Biology and taxonomy of the *Rhopalomyia* gall midges (Diptera: Cecidomyiidae) of *Artemisia tridentata* Nuttall (Compositae) in Idaho. — Contrib. Amer. Ent. Inst. 21: 1—90.
- Klausnitzer, B., 1977. Evolution der Insekten als Einmischungsprozess bei Angiospermen. — Biol. Rundschau 15: 366—377.
- Lawton, J. H., 1983. Plant architecture and the diversity of phytophagous insects. — Ann. Rev. Ent. 28: 23—39.
- Lawton, J. H. & P. W. Price, 1979. Species richness of



- parasites on hosts: agromyzid flies on the British Umbelliferae. — *J. Anim. Ecol.* 48: 619—637.
- Lawton, J. H. & D. Schröder, 1977. Effects of plant type, size of geographical range and taxonomic isolation on number of insect species associated with British plants. — *Nature* 265: 137—140.
- MacArthur, R. H. & E. O. Wilson, 1967. The theory of island biogeography. — Princeton University Press, Princeton, N.J.
- McKay, P. A. & J. H. Hatchett, 1984. Mating behavior and evidence of a female sex pheromone in the Hessian fly, *Mayetiola destructor* (Say) (Diptera: Cecidomyiidae). — *Ann. Ent. Soc. Amer.* 77: 616—620.
- Mamaev, B. M., 1968. Evolution of gall forming insects — gall midges. — British Library Lending Division, Boston Spa, Wetherby, translated by A. Crozy (1975).
- Metcalf, M. E., 1935. The germ cell cycle in *Phytophaga destructor* (Say). — *Q. J. Microsc. Sci.* 77: 585—604.
- Möhn, E., 1955. Neue freilebende Gallmücken — Gattungen. — *Deut. Ent. Zeitschr.* NF 2: 127—151.
- Möhn, E., 1961. Gallmücken (Diptera, Itonidae) aus El Salvador. 4. Zur Phylogenie der neotropischen und holarktischen Region. — *Senck. Biol.* 42: 131—330.
- Möhn, E., 1966. 6.L. Cecidomyiidae = (Itonidae). — In: Die Fliegen der palaearktischen Region, bij E. Lindner (ed.), pp. 1—41. — Schweizerbart, Stuttgart.
- Nijveldt, W. [C.], 1969. Gall midges of economic importance. VIII. — Crosby Lockwood & Son, London.
- Nijveldt, W. C. & A. J. A. Hulshoff, 1968. Waarnemingen inzake de tarwestengelgalmug (*Haplodiplosis equestris* Wagner) in Nederland. — *Inst. Plantenziektkundig Onderzoek, Med.* 459: 1—77 (Dutch with English summary).
- Orphanides, G. M., 1975. Biology of the carob midge complex, *Asphondylia* spp. (Diptera, Cecidomyiidae), in Cyprus. — *Bull. ent. Res.* 65: 381—390.
- Parnell, J. R., 1963. Three gall midges (Diptera: Cecidomyiidae) and their parasites found in the pods of broom (*Sarothamnus scoparius* (L.) Wimmer). — *Trans. R. Ent. Soc. Lond.* 115: 261—275.
- Price, P. W., 1977. General concepts on the evolutionary biology of parasites. — *Evolution* 31: 405—420.
- Regenfuss, H., 1978. Ursachen und Konsequenzen einer parallelen phylogenetischen Aufspaltung von Parasiten und Wirten. — *Sonderbd. naturwiss. Ver. Hamburg* 2: 83—99.
- Roskam, J. C., 1979. Biosystematics of insects living in female birch catkins. II. Inquiline and predaceous gall midges belonging to various genera. — *Neth. J. Zool.* 29: 283—351.
- Roskam, J. C., in press. Evolution of the gall inducing guild. — In: Biology of insect and acarina induced galls, by J. D. Shorthouse & O. Rohfritsch (eds). — Praeger, New York.
- Roskam, J. C. & G. van Uffelen, 1981. Biosystematics of insects living in female birch catkins. III. Plant — insect relation between white birches, *Betula* L., section *Excelsae* (Koch) and gall midges of the genus *Semudobia* Kieffer (Diptera, Cecidomyiidae). — *Neth. J. Zool.* 31: 533—553.
- Rothmaler, W., 1972. Exkursionsflora für die Gebiete der DDR und der BDR. Gefäßpflanzen. — Volk und Wissen, Berlin.
- Rübsaamen, E. H. & H. Hedicke, 1925—1939. Die Zoocecidien, durch Tiere erzeugte Pflanzengallen Deutschlands und ihre Bewohner. — *Zoologica* 29: 1—350.
- Skuhřavá, M., 1973. Monographie der Gallmückengattung *Clinodiplosis* Kieffer, 1894 (Cecidomyiidae, Diptera). — *Studie ČSAV* 17: 1—80.
- Skuhřavá, M., in press. Family Cecidomyiidae. — In: Catalogue of Palaearctic Diptera, by A. Soós & L. Papp (eds). — Elsevier, Amsterdam.
- Skuhřavá, V., 1970. Das Schadbild der Kiefernadelgallmücke *Thecodiplosis brachyntera* (Schwägr.) (Diptera, Itonididae) an Nadeln einiger *Pinus*-arten. — *Marcellia* 36: 229—241.
- Skuhřavá, V., 1982. The saddle gall midge *Haplodiplosis marginata* (Von Roser) (Diptera, Cecidomyiidae), an important pest of wheat and barley in Czechoslovakia. — *Folia Fac. Sci. Nat. Univ. Purkynianae Brunensis* 23: 133—135.
- Skuhřavá, V. & R. Hochmut, 1969. Befallsdichte der Kiefernadelgallmücke *Thecodiplosis brachyntera* (Schwägr.) an *Pinus silvestris* L. verschiedener Provenienz. — *Anz. Schädlingsk. u. Pflanzensch.* 42: 165—169.
- Skuhřavá, V. & M. Skuhřavá, 1982. Flugaktivität und Wirtspflanzenkreis der Sattelmücke, *Haplodiplosis marginata* (Von Roser) (Cecidomyiidae, Diptera). — *Wiss. Beitr. Martin Luther Univ. Halle-Wittenberg* 17: 263—271.
- Skuhřavá, V., M. Skuhřavá & J. W. Brewer, 1983. Ecology of the saddle gall midge *Haplodiplosis marginata* (Von Roser) (Diptera, Cecidomyiidae). — *Zeitschr. angew. Ent.* 96: 476—490.
- Southwood, T. R. E., 1972. The insect/plant relationship — an evolutionary perspective. — In: *Insect/plant relationships*, by H. F. van Emden (ed.), pp. 3—30. — Blackwell, Oxford.
- Southwood, T. R. E., 1978. The components of diversity. — *Symp. R. Ent. Soc. Lond.* 9: 19—40.
- Spungis, V., 1981. New species of gall midges from the tribes Oligotrophini and Porricondyliini. V. — *Latvijas Entomologs* 24: 43—55 (Russian with English summary).
- Strong, D. R., J. H. Lawton & Sir Richard Southwood, 1984. Insects on plants. — Blackwell, Oxford.
- Sylvén, E., 1970. Field movement of radioactively labelled adults of *Dasyneura brassicae* Winn. (Dipt., Cecidomyiidae). — *Ent. Scand.* 1: 161—187.
- Takhtajan, A. L., 1954. Origin of angiospermous plants. — *Amer. Inst. Biol. Sci.*, Washington, translated by O. H. Gankin (1958).
- Takhtajan, A. L., 1980. Outlines of the classification



- of flowering plants (Magnoliophyta). — *Bot. Rev.* 46: 225—359.
- Van Vreden, G. & K. Arifin, 1977. Bionomics of the rice gall midge *Orseolia oryzae* (Wood-Mason) with emphasis on insect — plant relationship. — *Contr. Centr. Res. Inst. Agric. Bogor* 27: 1—18.
- Verschaffelt, E., 1910. The cause determining the selection of food in some herbivorous insects. — *Proc. Acad. Sci., Amsterdam* 13: 536—542.
- Weis, A. E., P. W. Price & M. Lynch, 1983. Selective pressures on clutch size in gall maker *Asteromyia carbonifera*. — *Ecology* 64: 688—695.
- Yukawa, J., T. Ohtani & Y. Yazawa, 1983. Host-change experiments from wild plants to soybean in *Asphondylia* species (Diptera, Cecidomyiidae). — *Proc. Assoc. Pl. Prot. Kyushu* 29: 115—117 (Japanese with English summary).
- Zwölfer, H., 1978. Mechanismen und Ergebnisse der Co-evolution von phytophagen und entomophagen Insekten und höheren Pflanzen. — *Sonderbd. naturwiss. Ver. Hamburg* 2: 7—50.
- Zwölfer, H. & G. Bush, 1984. Sympatrische und parapatrische Artbildung. — *Zeitschr. Zool. Syst. Evol.-forsch.* 22: 211—233.















# TIJDSCHRIFT VOOR ENTOMOLOGIE

UITGEGEVEN DOOR

DE NEDERLANDSE ENTOMOLOGISCHE VERENIGING

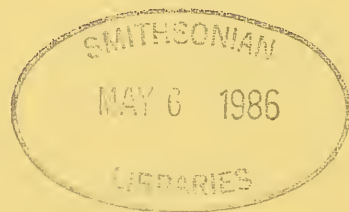

## INHOUD

- R. H. COBBEN. — Additions to the Eurasian saldid fauna, with a description of fourteen new species (Heteroptera, Saldidae), pp. 215—270, figs. 1—21, maps 1—4.



# ADDITIONS TO THE EURASIAN SALDID FAUNA, WITH A DESCRIPTION OF FOURTEEN NEW SPECIES (HETEROPTERA, SALDIDAE)

by

R. H. COBBEN

Department of Entomology, Agricultural University, Wageningen, The Netherlands

## ABSTRACT

The following new species of Eurasian Saldidae are described: *Halosalda coracina* (Greece), *Saldula basegawai* (far East USSR, Japan), *S. taiwanensis* (Taiwan), *S. sibiricola* (USSR: Kazakhstan), *Macrosaldula clavalis* (USSR: Georgia), *M. inomata* (Iraq), *M. kerzhneri* (USSR: Kazakhstan), *M. kokshetavica* (USSR: Kazakhstan), *M. miyamotoi* (Japan), *M. shikokuana* (Japan), *M. simulans* (Siberia, Mongolia), *M. violacea* (Far East of USSR, Japan), *Calacanthia grandis* (China), *Salda kiritshenkoi* (USSR: Central Asia, Far East, N. E. China, Japan). A new subspecies *M. oblonga acetabularis* is described from Kazakhstan. *Salda nevadensis* Wagn. and *S. littoralis piechockii* Wagn. are synonymized with *S. littoralis* L. Lectotypes are designated for *Salda micans* Jak., *S. splendens* Jak. and *Macrosaldula roborowskii* Jak. comb. n. (transferred from *Chartoscirta*). The *Macrosaldula* clade is discussed; it is provisionally taxonomically treated as a genus. A tentative key is presented for 21 species of *Macrosaldula* presently recognized in Eurasia. Preliminary redefinitions of *M. jakovleffi* Reut. and *M. nivalis* Lindb. are provided, whereas the status of *M. mongolica* Kir. needs further confirmation. The known localities of *Macrosaldula*, *Teloleuca* and *Salda* species (except for those from W. Europe) are mapped and the zoogeography of these genera is briefly discussed.

## CONTENTS

Introduction .....	215
Description of species and comparative notes .....	217
Discussion of Eurasian <i>Salda</i> species .....	246
Tentative key to <i>Macrosaldula</i> species .....	254
Comments on the zoogeography of <i>Macrosaldula</i> , <i>Salda</i> and <i>Teloleuca</i> .....	262
Acknowledgements .....	263
References .....	263

## INTRODUCTION

The present study is based predominantly on a revision of saldid material collected by Russian and Japanese heteropterists in the eastern parts of the Palaearctic. I have added some new species from Greece, Iraq and China, which certainly belong to supraspecific taxa having originated in the northern hemisphere of the Old World. The description of one species from Taiwan is included here as well, although it may be a member of a species group from a more southern origin. Although the description of some species is based on only scanty material and, consequently, the knowledge of variability

and distributional patterns is limited, I refrained from a further delay of publication. This revision may stimulate the study of material I have not seen, and exploration of areas from which no or only sparse data are available. Detailed ecogeographical analyses of population structures of selected species groups, as for example undertaken by Dr P. Lindskog (in prep.) on the complex *S. orthochila-burmanica* (see p. 225), are dependent on more numerous material than I had the opportunity to study.

The present paper does not include a revision of the abundant material in Russian and Japanese collections of small-sized typical *Saldula* and *Micracanthia* species. Such a revision is urgently needed in order to understand the zoogeography of these world-wide genera with preponderance of species occurring in the northern hemisphere. I sincerely hope that Dr N. N. Vinokurov (Yakutsk, USSR), who initiated a fine, detailed study on this difficult group of saldids in Eastern USSR (Vinokurov, 1975, 1978, 1979a—c, 1981), will eventually be successful in preparing a comprehensive revision. We may expect more examples of Holarctic dis-



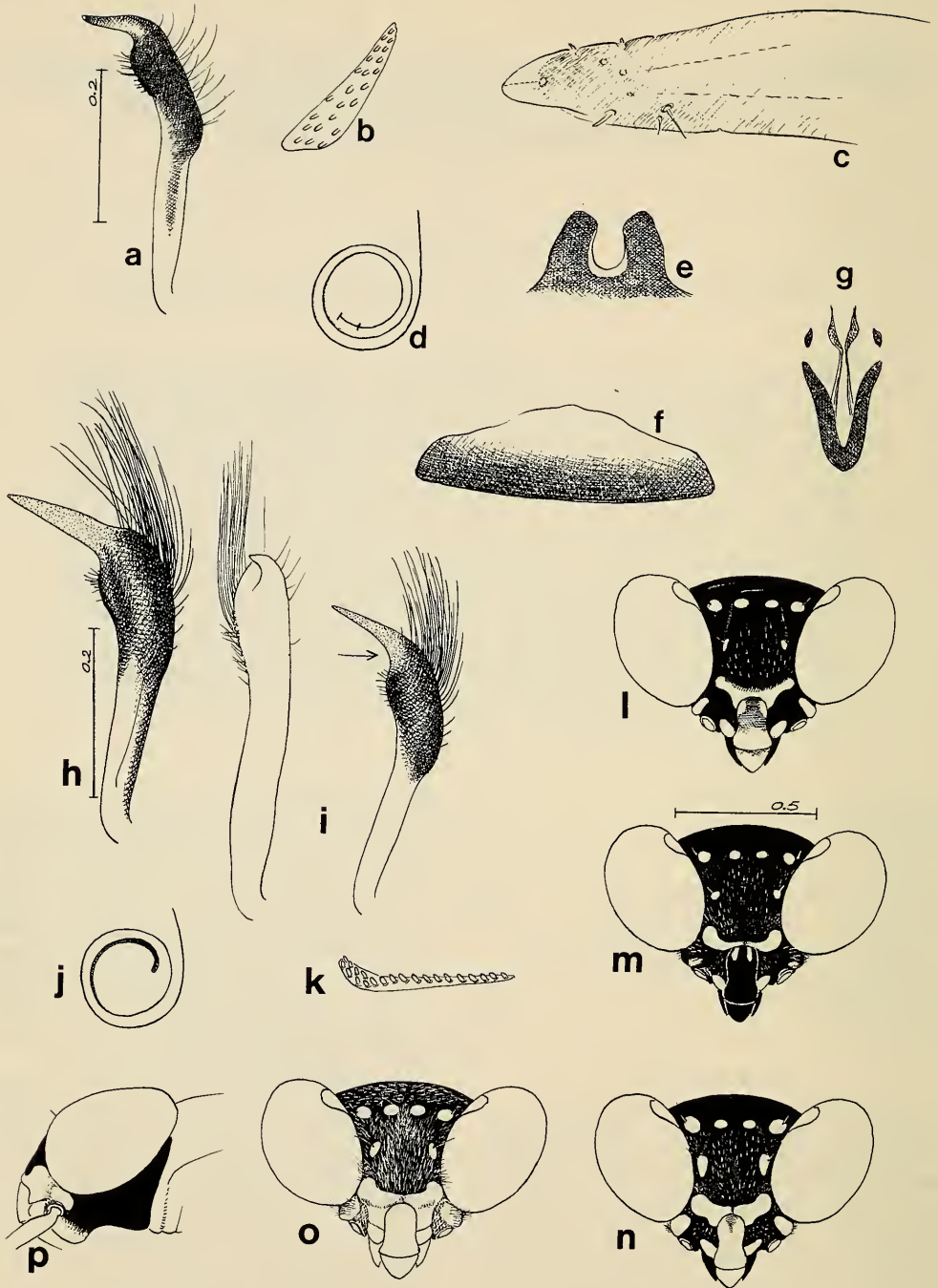

Fig. 1. a—g, *Saldula hasegawai*. a, paramere; b, grasping plate of ♂; c, apex of paramere; d, base of penisfilum of two specimens; e, parandria; f, subgenital plate; g, median endosomal sclerite. h—p, *Halosalda*. h, o, p, *H. lateralis*; i, j—l, *H. coracina*; m, n, *H. concolor*; h, i, paramere, left figure of i as seen in direction of arrow in right figure; j, penisfilum; k, grasping plate; l—o, frontal aspect of head; p, left view of head.

tribution to be added to those presently known.

Eight of the new species described below belong to a group of species which is treated here as the genus *Macrosaldula*. A preliminary discussion on its status is given on page 232 and a key to the 21 species now recognized is added. I intend to devote a separate paper to the pressing problem of generic delimitations in the Saldidae after publication (Cobben in press) of descriptions of some twenty new taxa, mostly from Africa.

I dedicate this paper to Prof. A. N. Kiritshenko (1884—1971), the founder of Russian saldid taxonomy who had already labelled some presently described species as new to science in Russian collections.

DESCRIPTION OF SPECIES AND COMPARATIVE NOTES

*Halosalda coracina* sp.n.  
(figs. 1 i—l; 2a, b).

Description. — For measurements, see table 1. Typical *Halosalda* habitus, but dorsal cuticle completely bare, highly smooth and polished. Greece.

The characters of this new species are presented in comparison with conditions in the other two *Halosalda* species. Since only of *H. lateralis* (Fallén, 1807) and *H. concolor* (Putton, 1880) macropters are known, comparisons below refer to semibrachypterous specimens (forewing more or less coleopterous due to substantial reduction of membrane).

	<i>coracina</i> sp.n.	<i>concolor</i>	<i>lateralis</i>
body length in mm ♂	3.4—3.6	3.2—3.7	3.2—4.1 <sup>1)</sup>
♀	3.7—3.8	3.6—4.0	3.6—4.6 <sup>1)</sup>
general coloration	type series uniformly black, apex of wing often narrowly pale; pronotum entirely black, rarely with lateroventral pale streak	variable (see figs. 102—105 in Cobben, 1960); extension of black pigment spreading in eunomic series from mesocorium outward; predominantly dark specimens in west mediterranean	highly variable, but pale specimens predominating (see figs. 94—98 in Cobben, 1960); extension of dark pigment in wing starting from lateral sides
structure of forewing	strongly coreaceous and transversely vaulted; remnant of membrane not visibly demarcated from corium	as <i>coracina</i> but less vaulted; membrane weakly set off from corium	not coleopteroid, dorsum in cross-section weakly convex; visible borderline between corium and membrane
cuticle of forewing	highly polished, entirely smooth without any sculpture, commissure between clavus and corium lined with a row of pits	shiny, weakly rugose; suture between clavus and corium indistinct	weakly shining, clearly rugose; suture between clavus and corium not obvious, but claval ridge along inner side of commissure distinct
texture of dorsum	hairless	with very scattered short adpressed setae (distance between setae wider than length of setae)	with rather dense regular coat of short decumbent setae (distance between setae much shorter than length of setae).

<sup>1)</sup> These numbers refer to specimens from various origins; the mean value for material from the west continental coasts is clearly higher than for specimens from the British Isles and countries bordering the Black Sea.

ratio: width/length of pronotum	♂ 2.05—2.25 ♀ 2.35—2.50	2.50—2.70 2.65—2.90	2.60—2.75 2.70—2.95
scutellum	anterior mid part with shallow depression	flat	flat
head	very polished, frons with only few scattered setae; white parties of mouth sclerites mostly as in fig. 1l, sometimes as in fig. 1m or in between fig. 1m and n, but lateral edges of transverse band (postclypeus) never that swollen	rather shiny, frons somewhat rugose, moderately beset with short setae (fig. 1m, n); pigmentation of mouth sclerites varying between fig. 1m and n, and sometimes grading into fig. 1o, particularly in specimens from Cyprus	rather dull, frons and vertex thickly covered with pale setae (fig. 1o); mouth sclerites extensively light-coloured; post-clypeus transversely well-developed, fused with mandibular plates and lateral swellings between eye and antennal socket
antennae	dark brownish, inner side of segment 1 yellowish	dark specimens: segment 1 and 2 pale, outer side with brown streak; light-coloured specimens from Cyprus: entirely pale	entirely pale, segment 1 and 2 often with dark line along external side
legs	first acetabula largely pale; coxa blackish, femur and tibia ochreous with dark longitudinal stripes	dark specimens: first acetabula narrowly or largely pale; legs with short brownish stripes; lightest specimens: all acetabula and entire legs whitish	as in <i>concolor</i>
genitalia	parandria slender (fig. 2b)	parandria blunt (fig. 2c)	parandria blunt (fig. 2c)
known geographic distribution	coast of NE Greece	Mediterranean (Italy, France, Spain, Tunisia, Cyprus, Corfu)	widely Palearctic

Material. — Holotype (♂), Porto Lagos, NE Greece, 23.viii.1983, leg. R. H. Cobben. Paratypes 9 ♂ 4 ♀, idem. Holotype and paratypes in coll. Wageningen<sup>1)</sup>, paratypes in Leningrad coll. and in coll. Drosopoulou, Athens.

Comparative notes. — The type series, all strongly semibrachypterous, was collected on open patches of moist sandy soil in *Salicornia* vegetation in the dunes bordering the Aegean

Sea. The species occurred simultaneously with *H. lateralis*. Since sampling was done in the evening twilight and only two specimens of *H. lateralis* were seen, the possibility of a difference in the daily period of activity between both species cannot be excluded. The most reliable character of *H. coracina* separating it from the other two species, lies in the lack of any dorsal sculpture and pilosity. As regards the coloration, the new species forms the most dark extreme of a gradual series of colour morphs, in which *H. lateralis* represents the opposite extreme of predominantly light-coloured specimens. *H. concolor* has a more or less intermediate position, at

<sup>1)</sup> The indication "coll. Wageningen" throughout this paper means: the collections of the Department of Entomology of the Agricultural University at Wageningen.



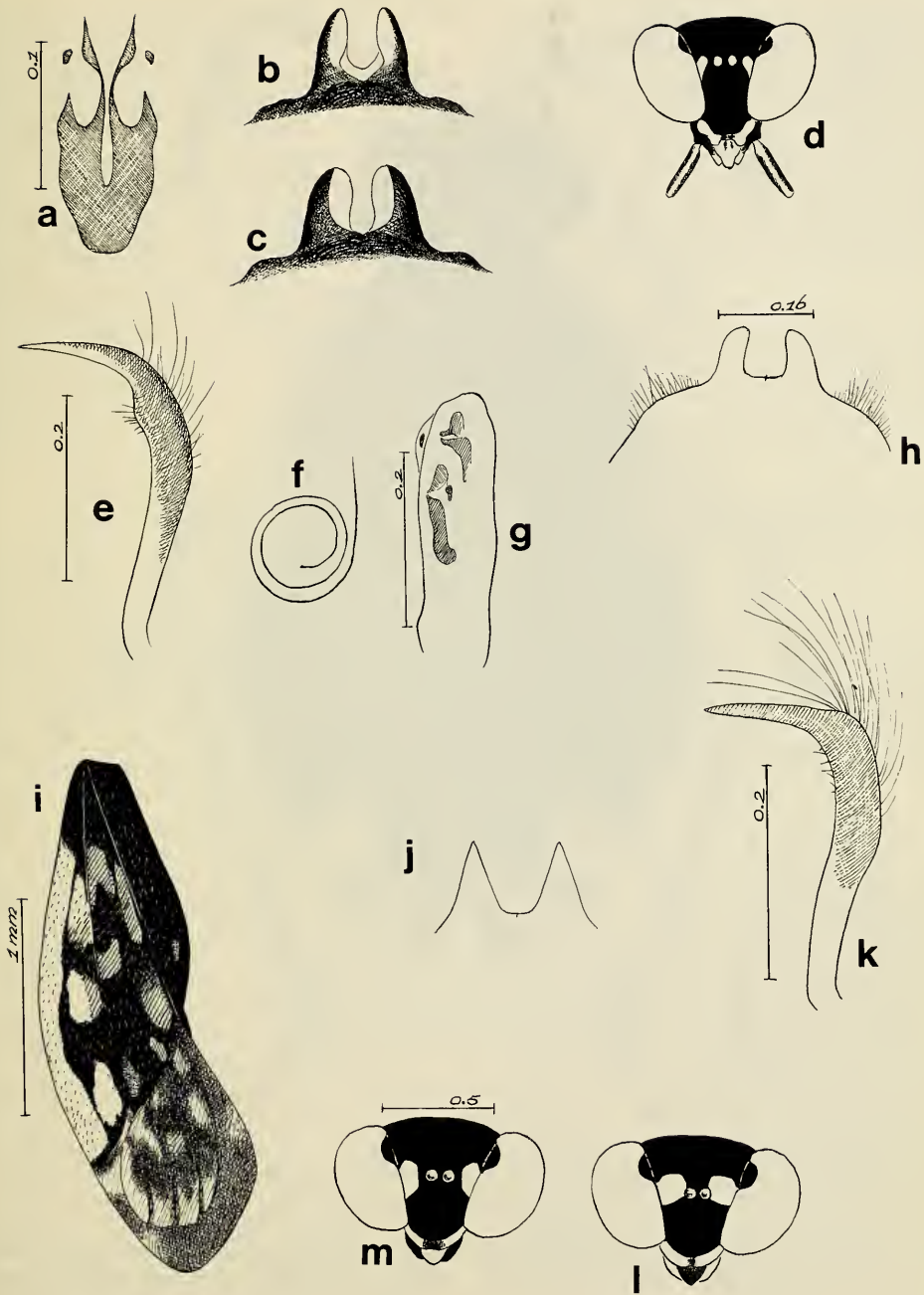

Fig. 2. a—c, *Halosalda*. a, *H. coracina*, median endosomal sclerite; b, c, parandria of *H. coracina* (b), *H. lateralis* and *H. concolor* (c). d—i, *Saldula taiwanensis*. d, frontal aspect of head of ♂; e, paramere; f, penisfilum; g, left view of penis; h, parandria; i, left fore wing. j—l, *Saldula inoana*. j, parandria; k, paramere; l, frontal aspect of head of ♂; m, *Saldula uichancoi*: frontal aspect of head of ♂.



Fig. 3. *Saldula basegawai*, general facies of ♀.

least in the western mediterranean, where I often collected it together with *H. lateralis*. A population from Cyprus (near Akrotiri, 21.vi.1951, leg. G. Mavromoustakis), which on the basis of cuticular structure and paucity of setae definitely belongs to *H. concolor*, is considerably different. All its individuals are extremely lightly pigmented. Some are even more pale than the lightest individuals of *H. lateralis* I

have seen, the mid frontal pale spots on the head conjugating with the transverse postclypeal swelling. This sample from Cyprus furthermore contains a high percentage of macropters (6 macropteres, 4 semibrachypters), the first seen in *H. concolor*. Although Akrotiri is close to the sea, the locality label mentions "in fresh water marshes". This fits in with my own and Josifov's (1957) experience that the macropters of

*H. lateralis* are occasionally found outside the main habitat of the species.

It is expected that *H. coracina* occurs further eastward in coastal salt-marshes in Turkey. My collections from more south-eastern and western parts of Greece so far revealed only the presence of *H. lateralis*. The distribution pattern of *H. concolor* is still fragmentary, and collections containing material from southern origins identified as *H. lateralis* need to be reinvestigated. On my request, Dr Kerzhner checked the abundant material in the Leningrad Museum and concluded that it all refers to *H. lateralis* proper. This Euro-Siberian species occurs all over Europe inclusive of Scandinavia and its eastern range covers East-Mongolia and Transbaikal.

### *Saldula hasegawai* sp.n.

(figs. 1a—g; 3)

Description. — For measurements, see table 1. Rather small (3.0—3.6 mm), head and thorax black, glossy, wing dull-black with ochreous wing margin, semibrachypterous (membrane half-way reduced), whole body with long pilosity. Japan, Far East of the USSR.

Head: black, spherical preocellar spot and all mouth-part sclerites, gular lobe and rostrum yellowish brown; glabrous yellowish white tumescence in between antennal socket and eye; dorsal surface with numerous erect dark setae as long as the trichobothrial setae and with recumbent short golden setae; eyes with short setae; underside with semilong adpressed silvery setae. Thorax: black, glossy, densely covered dorsally with upstanding black setae and recumbent semilong light setae; pronotum with distinct collar, separated from callus by row of pits, lateral sides weakly convex or straight, frontal edges not wider than collar; dome about two-and-a-half times as long as posterior lobe, posterior border of dome lined with pits.

Wing: ashy black, clavus without apical pale spot, endocorium entirely dark in specimens from Japan, with one slight spot in centre and another one on inner edge in specimens from E. USSR; exocorium convex laterally, with light brown lateral margin extending in light subbasal and apical spot; with long erect brown and recumbent, shaggy, semilong golden setae; membrane distinctly reduced, dark smoky with ochreous spots or entirely testaceous; hypocostal lamina without secondary oblique ridge; apex of hind wing reaching level of base of membrane.

Extremities: ratio of antennal segments 1 : 2.1 : 1.5 : 1.5, segments 1 and 2 brown, shining, with erect brown setae, which are slightly longer than diameter of segment, and some setae of greater length on segment 2; segments 3 and 4 dark-brown with short white setae and scattered dark erect bristles. Legs unicolorous light-brown, acetabula and coxae black; tibiae with erect brown setae, which along outer margin are longer than width of tibiae, and dark spines as long as tibial diameter.

Other structures: rudiment of larval organ and sclerites of pregenital gland present; subgenital plate of ♀ broadly truncate (fig. 1f), grasping plate of ♂ with some 23 pegs (fig. 1b); parandria and paramere as figured (figs. 1e, a, c), penisfilum coiled 2½ times, endosomal sclerite of normal shape (fig. 1g).

Holotype ♂, length 3.16 mm, width 1.70 mm. Paratypes, 4 ♂, length 2.8—3.05 mm, width 1.6—1.7 mm, 5 ♀, length 3.2—3.7 mm, width 1.78—1.9 mm.

Material. — Holotype (♂), Japan, Osorezan, Aomori Pref., 2.viii.1953, leg. H. Hasegawa (in coll. Wageningen). Paratypes, 3 ♂ 4 ♀, idem (in Hasegawa coll.); 1 ♂ 1 ♀, USSR, Sudzuke (now Zapovednyy), 25 km S of Sokolovka Primorskiy Kray, coast of Japanese Sea, 22.viii.1959, leg. I. Kerzhner; 1 ♂, near Vladivostok, 26.vii.1925, leg. Rostovkykh (in coll. Leningrad Museum).

Comparative notes. — Superficially this new species resembles on the one hand the *Micranthia fennica* group in general facies, pigmentation (fig. 4g—j) and shape of the paramere (fig. 4a—f), and, on the other hand, the Nearctic *Saldula bouchervillei* (Prov.) (fig. 4m), *S. orbiculata* Uhl. (fig. 4n) and *S. severini* Harr., in colour pattern and pilosity. Particularly the resemblance with *S. orbiculata* is rather strong, but unlike in that species the pruinose areas on the wings are lacking in *S. hasegawai*. Besides smaller specific differences (e.g. in shape of parameres, compare fig. 1a with figs. 4k, 1), *S. hasegawai* deviates clearly from all these species in having a glabrous, lightish tumescence between antennal socket and eye, and in not having the secondary hypocostal ridge.

### *Saldula taiwanensis* sp.n.

(fig. 2d—i)

Description. — For measurements, see table 1. Rather small (3.5—4.0 mm), short-haired, head and thorax black, moderately shiny, wings fully developed, with black, bluish pruinose



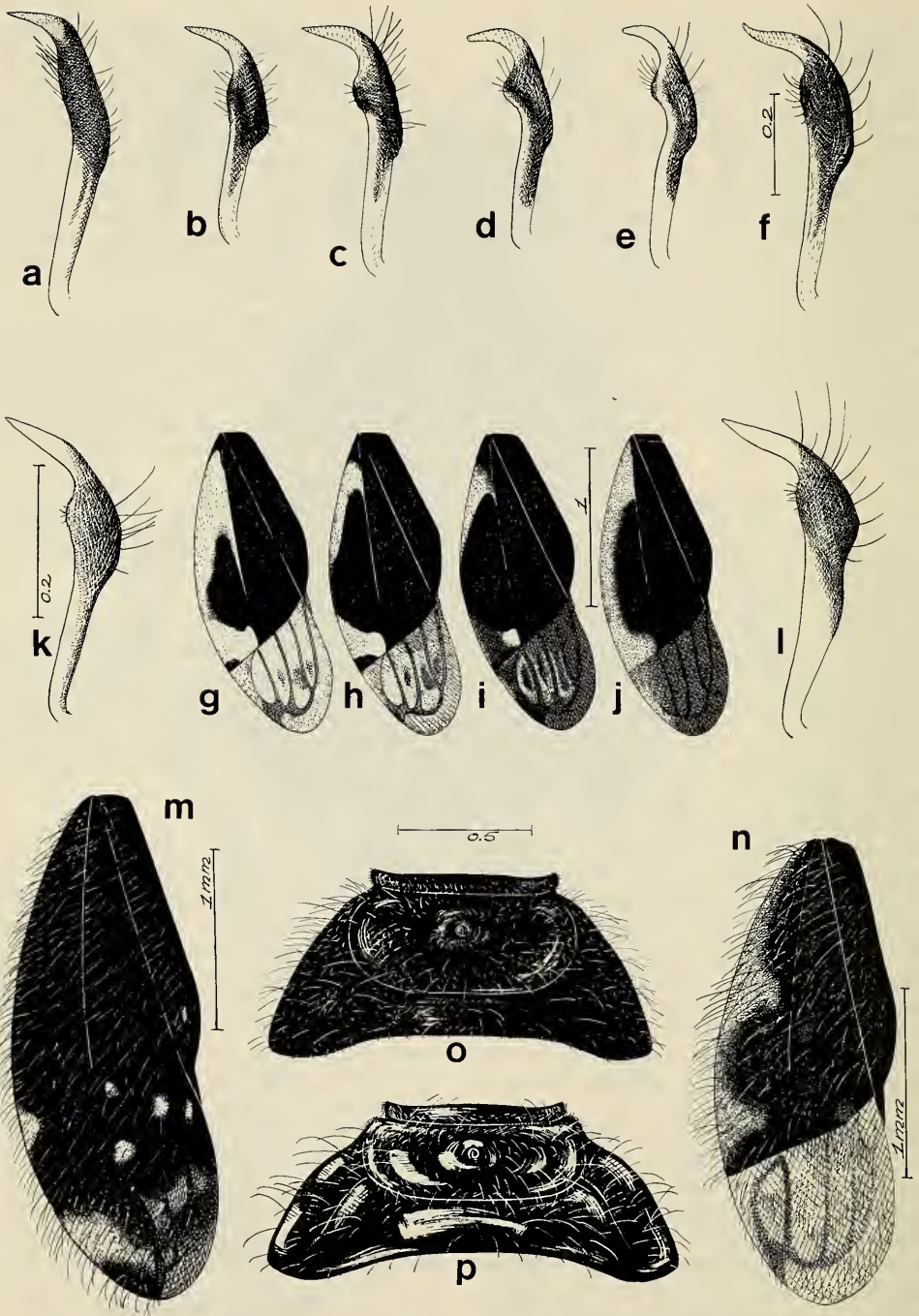

Fig. 4. a—j, *Micracanthia*. a—f, paramere; g—j, left fore wing. a, *M. marginalis*; b, *M. humilis*; c, *M. drakei*; d, *M. husseyi*; e, *M. pumpila*; f, *M. floridana*; g—i, *M. marginalis*; j, *M. fennica*; k, m, o, *S. bouchervillei*. l, n, p, *S. orbiculata*. k, l, paramere; m, n, left fore wing; o, p, pronotum.

and white markings more or less like in the genus *Chartoscirta*. Taiwan.

Head: black, anteclypeus, maxillary and mandibular plates largely yellowish, labrum black with central part lightish, apex of gular lobe yellowish, preocellar spot broadly touching eye margin (fig. 2d); short adpressed golden hairs, vertex with several semilong erect black setae, underside with dense silvery pubescence; rostrum brown, reaching in between hind coxae. Thorax: black, rather shiny, with adpressed short golden pubescence, side margin of pronotum straight or weakly concave, front edges slightly wider than collar; acetabula black.

Wings with irregular golden pubescence, on mid part somewhat shaggy, clavus with only apical, small lightish spot, embolium yellowish with black base; distribution of black, white and pruinose areas of corium and pigmentation of membrane as in fig. 2i; hypocostal suture present.

Extremities: antennae, length of segments given in table 1, nr. 3, segment 1 yellowish brown, underneath black; other segments dark brown with short brown hairs, additional erect hairs on segments 3 and 4 not longer than diameter of segment. Legs yellowish, coxae dark brown, femora ventrally with dark streak, flat sides with brown dots; knees and apex of last tarsal segment fuscous.

Other structures: larval organ present, stigmata not contacting side margins of sternites, male coupling plate with about 18 small pegs. Genital capsule of male with erect long brown setae on dorsolateral sides; parandria widely separated (fig. 2h); paramere with sharp processus hamatus (fig. 2e); length of penisfilum and phallic sclerites as in figs. 2f and g. Subgenital plate of ♀ broadly rounded, whitish.

Material. — Holotype (♂), Taiwan, Baron-Nishimura, 10.viii.1941, leg. H. Hasegawa (in coll. Wageningen). Paratypes idem 8 ♂ 3 ♀ (in coll. Hasegawa and Wageningen); M. Taiwan, Keishinryo, nr. Chuchi, 1 ♂, 15.iv.1965, leg. T. Saigusa (in coll. Miyamoto).

Comparative notes. — The external aspect of *S. taiwanensis* resembles very much the Palearctic *Chartoscirta cincta* (H.-S). The new species, however, lacks the leg-wing sound producing mechanism altogether; the unique shape of the plectrum is diagnostic for *Chartoscirta*. Other characters (shorter first antennal segment, male genitalia) also prevent inclusion into *Chartoscirta*. The new species also has some superficial resemblance to species of the *S. fletche-*

*ri* group (e.g. *S. fletcheri* (Dist.), *S. inoana* Dr., *S. uichancoi* Dr. & Viad.). Male genitalia (fig. 2j, k), and other characteristics (fig. 2l, m) of this group are quite different from *S. taiwanensis*.

***Saldula burmanica*** Lindskog, 1975 subsp.n.? (fig. 5a—d, f, g)

Description. — For measurements, see table 1. Medium sized (3.4—4.6), mounticolous species of the *orthochila* group, coalblack with dense, often conspicuous semierect dark pubescence, shining head, thorax and lateral wing margin; wing mostly with some greyish white spots, clavus most often with subbasal and subapical spot; polymorphous, usually broadly subovate subbrachypterous. Himalayan mountain chain, India, Nepal.

Head: rather shining, with recumbent light setae and some semilong dark setae which are shorter than the trichobothrial bristles, eye with scattered, very short setae; preocellar spot triangular, one side adjacent to eye; middle pair of trichobothrial setae on weak, black tumescence; anteclypeus with two bristles; mouthpart sclerites pale yellowish, more darkened in female, gular lobe black, rostrum light or dark brown. Thorax: shiny, glossy, with some light adpressed setae and an irregular vestiture of erect short or semilong dark setae; pronotum (fig. 5g) with straight or slightly convex lateral sides, proximal side somewhat wider than collar, dome not reaching side margins of pronotum, central pit deep, posterior margin indicated with row of pits; first acetabula with narrow pale margin, acetabula 2 and 3 entirely black.

Hemelytron (fig. 5f): dull, lateral explanate strip of exocorium and R + M ridge deep black, shining; other wing parts ashy grey and black with regular, rather short, semierect dark setae and some scattered golden adpressed setae, length of semierect setae subequal to width of hind tibia; clavus mostly with a small subbasal and subapical light spot, sometimes indistinct or absent; endocorium with varying number of small light spots, maximum number six, two near R + M ridge, four in distal part, light spots sometimes pruinose; exocorium with maximally three pale spots in the inner region and one larger spot distally near the wing margin; this latter spot remaining visible in otherwise entirely black specimens; membrane shining, dark-light pattern more or less as in fig. 5f, mostly subbrachypterous to varying degrees, sometimes tending to semibrachyptery at high altitudes (ca. 3000 m), hind wing as long as fore



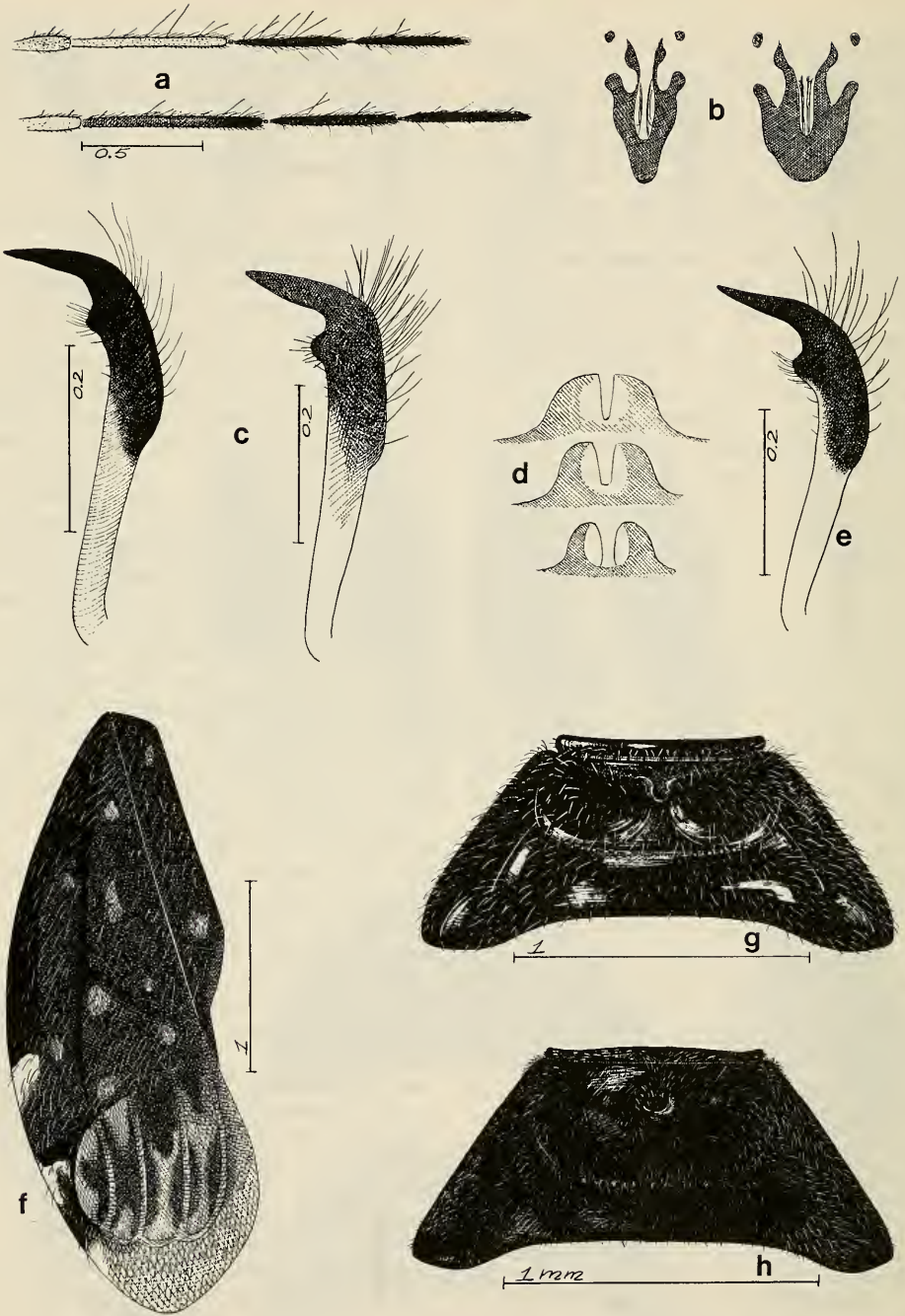

Fig 5. a, Antenna of *S. orthochila* from W Europe (above) and from *S. burmanica* (below); b, median endosomal sclerite of *S. orthochila* (left) and *S. burmanica* (right); c, paramere of *S. burmanica* from Nepal (left), India (right); d, parandria of *S. burmanica* from India (above), Nepal (middle), of *S. orthochila* (W Europe); e, paramere of *S. orthochila* from the Netherlands; f, g, *S. burmanica*; f, fore wing; g, pronotum; h, pronotum of specimen of the *burmanica* group from Vietnam.



wing or reduced till apex of clavus of fore wing; submacropterous condition of fore wing rare.

Extremities: Antennae shining, segment 1 light brown with some semilong dark bristles; segment 2 light or dark brown with short dark setae and some erect semilong dark setae along median side, 2—3 times as long as width of segment (fig. 5a below); segments 3 and 4 black; ratio of segments 1 : 2.5—2.6 : 1.7—1.8 : 1.9—2.1. Legs shining, testaceous, with short light brown pilosity, coxae black, femora with dark blots on flat sides and ventrally with black stripe; base, mid part and apex of tibiae darkened, black spines as long as diameter of tibia, last tarsal segment dark brown.

Other structures: larval organ absent, sclerite of pregenital gland present; subgenital plate of female broadly rounded, black, caudal margin sometimes narrowly pale; coupling plate of male with about 20 pegs in three rows, parandria broad, nearly adjacent (fig. 5d), paramere with acute-angled, black processus hamatus and pronounced processus sensualis with long, brown setae (fig. 5c); median endosomal sclerite as in fig. 5b, right; penisfilum coiled two times. Length of 10 ♂ 3.4—4.1 mm, width 1.8—1.9 mm; of 5 ♀ 3.9—4.9 mm, and 2.1—2.4 mm, respectively.

Material. — India: W. Almora, 2 ♂ 3 ♀, Kumaon, (no date), leg. H. G. Champion; Kumaon, Nainital, 1 ♀, (no date), leg. H. G. Champion; Chakrate Div., 2,300 m, 1 ♂, 1.vii.1932, leg. H. G. Champion; Unyal gaon, Sallana Tehri, Garhwal, near stream, 1830 m, 1 ♂ 1 ♀ 2.vi.1946, leg. J. K. Unyal; Uttar Pradesh, Mussoorie, 1500—2200 m, 1 ♀, 3—14.viii.1978 (Copenhagen Zool. Mus. Exp.); Gopaldhara, Darjeeling, 1500—2000 m., 1 ♀, 16.ix.1917, leg. H. Stevens; Sikkim, Karponang 3,300 m, 2 ♀, 16—24.iii.1917 (leg. H. S.); Sikkim-Nepal frontier, Tonglu, 3,350 m, 1 ♀, vii—viii. 1919, leg. H. Stevens; Nepal: R. G. Yack Exp. 1 ♂, 12.vii.1972, leg. R. A. Laurence; Pangboche, 4000 m, shore of marsh, 14 ♂ 4 ♀, 11.vii.1964; Junbesi, 2900 m, 1 ♀, 28.vii.1964; between Those and Junbesi, 1 ♀, viii.1974, leg. C. Ravaccia; Puiyan, 2900 m, mist-forest, 19.vii.1964; Thangpoche, 3500 m, 1 ♂, 11.vii.1964; Pheriche, 4350 m, shore of swamp, 11 ♂ 7 ♀, 10.vii.1964, all. leg. R. Remane; Alm Darghari, Maharigaon, 4000 m, 1 ♀, ix.1971, leg. H. Franz; between Mulkharka and Tare-Pati, 1 ♀, ix—x.1971, leg. H. Franz; Langtan vall., 1 ♂ 1 ♀, 23.iv.1978, leg. H. Kraigher; Gufa, Terhathum Distr. 2950—3000 m, 1 ♂ 1 ♀, 29.x.1979, leg. M. Tomokuni; Ting Sang La, 3400 m, 1 ♂ 1 ♀, 13—15.iv.1973, leg. J. Martens.

Comparative notes. — I must give an explanation for the description of and discussion on a taxon presented here, which was perfectly described by Lindsog (1975) as *S. burmanica*,

based on 3 ♂ and 4 ♀ from one locality (1200 m) in NE Burma. Since more than 15 years I had in my collection specimens from high altitudes in India which I described in manuscript as a new species. In recent years I saw additional material from many localities in the Himalaya. Since my and also Lindsog's (1975, p. 170) belief was that indeed a valid species was involved, I prepared its formal description for the present paper. The manuscript of the present paper was sent to Dr Lindsog for his comments. Meanwhile Lindsog had also received many additional specimens of "the new species" and he wrote me that he is now inclined to consider it at most a subspecies of *S. burmanica* Lindsog. Having seen now the holotype and paratypes of *S. burmanica*, which were kindly sent by Lindsog for comparison, I agree with Lindsog's conclusion. Since the whole body of my manuscript had already achieved its final stage, inclusive the illustrations, I retain here my original text, with only some necessary amendments. I leave the final decision on the taxonomic status to Per Lindsog who is preparing a detailed study of the *burmanica-orthochila* complex. His paper will provide a much more detailed and geographical analysis than presented here.

*Saldula orthochila* Fieber, the closest relative of *S. burmanica*, differs in the following respects: more slender (ratio body length: width about 2.1—2.2, as against 1.8—2.0 in the *S. burmanica* form considered here); without long erect black setae on head and thorax and without erect dark pilosity on hemielytra; recumbent light setae more numerous; head and thorax less shining; first acetabula broadly light; lateral strip of fore wing dull, membrane for the major part hyaline (see for more differences Lindsog, 1975, p. 165). *S. orthochila* has a very wide distribution covering nearly all West European countries, and it is recorded eastwards from S Russia, Turkestan and Siberia (Cobben, 1960). Iran is added here as a new country record (Mazanderan, Chalus-valley, 1300 m, 1 ♀, 13.viii.1968, leg. Heinz). I have seen material from 3000m altitude in Tibet (Supi River, no date, 6 ♂ 14 ♀, leg. H. G. Champion, in Coll. BMNH, London) and from Kashmir (Rukshu, Tso-Morari, near frontier Tibet, 1 ♂, vii.1914, leg. G. Babault, in Coll. Smiths. Inst. Washington). These match specimens from W Europe, except for varying colour of second antennal segment (dark brown to light brown), for some long erect setae on head and pronotum, and for

somewhat denser and longer pilosity on the wings. Increasing pilosity at higher altitudes is also seen in other saldids (e.g. *Saldula saltatoria*), but the pilosity of *S. orthochila* remains much less dense than in *S. burmanica*. The semibrachypterous *orthochila* from Tibet have further reduced hind wings, reaching about the apex of the clavus; the extending setae on the second antennal segment are of varying length, mostly shorter than in western populations. On the basis of all these characters, the *orthochila* material from Tibet seems somewhat intermediate between typical *S. orthochila* and *S. burmanica*. A study of the geographic variation of additional populations from western and more eastern parts of the Himalaya is needed in order to define subpopulations of *S. orthochila* and *S. burmanica*.

To my surprise, I came across one female from N Vietnam, which means a considerable extension of the known *orthochila-burmanica* chain. The specimen in the Smithsonian Institution, Washington, is labelled: Tonkin, Chapa, v.1916, leg. R. V. de Salvaza. It is long-winged, 4.51 × 2.20 mm, and conforms most to the description of *S. burmanica* (second antennal segment light-brown with mediolateral setae about two times as long as width of segment; area around subapical spot of clavus concolorous with the rest of clavus). The aspect of the pronotum (fig. 5h) seems to differ somewhat in that it tapers more narrowly towards the collar than in *orthochila* and our form of *burmanica* (fig. 5g). The taxonomic evaluation of the Vietnam individual must wait till males are available from that territory. It presumably lives there at high elevations. An extensive survey of the habitat and ecology of the *orthochila* group of species is presented by Lindskog (1975). Another species of this group, defined by the character set: second antennal segment with some erect bristle-like setae and absence of the larval organ, is *S. nobilis* Horv. with a Central European-Asiatic distribution. It is a mountainous species and the known records are scattered (see map 1). I have now seen the first specimens from Japan (Hokkaido, Kiyokawa near Ashora, 2 ♂ 1 ♀, 7.vii.1958, leg. S. Miyamoto; Berabonai, Ashoro, 1 ♀, 8.vii.1958, leg. S. Miyamoto; Kutyaroko, 1 ♀, 11.viii.1937, leg. S. Asahina) and from China (Manchuria, 1 ♀, 25.vii.1943, leg. E. Kawase). Lindskog (1975) referred to *S. boucherillei* Prov. (= *S. illinoensis* Dr.), a Nearctic species exhibiting phenetic affinities to the *orthochila* group. This species indeed has no larval

organ as is typical for the *orthochila* group. A reliable cladistic analysis of the species clusters of the genus *Saldula* would ultimately bring out whether the Palaearctic and the Nearctic assemblage of species, lacking the larval abdominal organ (Cobben, 1957, 1959), form together a monophyletic group. An independent loss of that organ seems probable. Other species in the Nearctic Region, which lack such organ, belong to different complexes. They are *S. villosa* Hodg. (California, Oregon) on the one hand, and *S. laevis* Champ. and *S. sulcicollis* Champ., both from Guatemala and Mexico, on the other hand. *Oiosalda caboti* Drake & Hoberlandt, 1952 (Colombia) seems to be most closely related to the latter two species, but actually possesses a larval organ. Definitely not closely related to the *orthochila* group, but nevertheless without a larval organ, is a complex of species from India and surrounding countries (*S. championi* Dr., *edita* Dr. & Hoberl., *fletcheri* Dist., *pusana* Dist.).

*Saldula sibiricola* sp.n.  
(fig. 6f—n)

Description. — For measurements, see table 1. Medium-sized (4.3—5.7 mm), belonging to the *orthochila* group, very close to *S. nobilis* Hórvath, but with more extended testaceous elytral markings. Siberia.

Head: wide (0.7—0.8 × width of pronotum), shiny black, preocellar spot elongate triangular with longest side along eye; all mouth sclerites lightish in ♂, black in ♀ except for anteclypeus and labrum, which are sometimes fuscous; with shaggy adpressed lightish setae; postclypeus, frons and vertex also with many extending dark setae nearly as long as trichobothria; eyes with scattered short setae; rostrum dark brownish, reaching or slightly surpassing hind coxae. Thorax: black, shiny, with irregular golden pubescence and erect brown setae; pronotum narrow (ratio length/width 0.5 in submacropterous, 0.35 in macropterous specimens), lateral sides weakly concave, fore edges not much wider than the distinct collar; dome well-developed and elevated, reaching lateral sides, length medially 1.45 × posterior part of pronotum; first acetabula entirely white, 2 and 3 with pale apex.

Wings: mostly submacropterous fore wings, hind wings reaching middle of membrane, one female macropterous, weakly shiny, with scattered golden recumbent setae on corium and veins of membrane; corium and clavus with dense pilosity of erect long brown setae (about



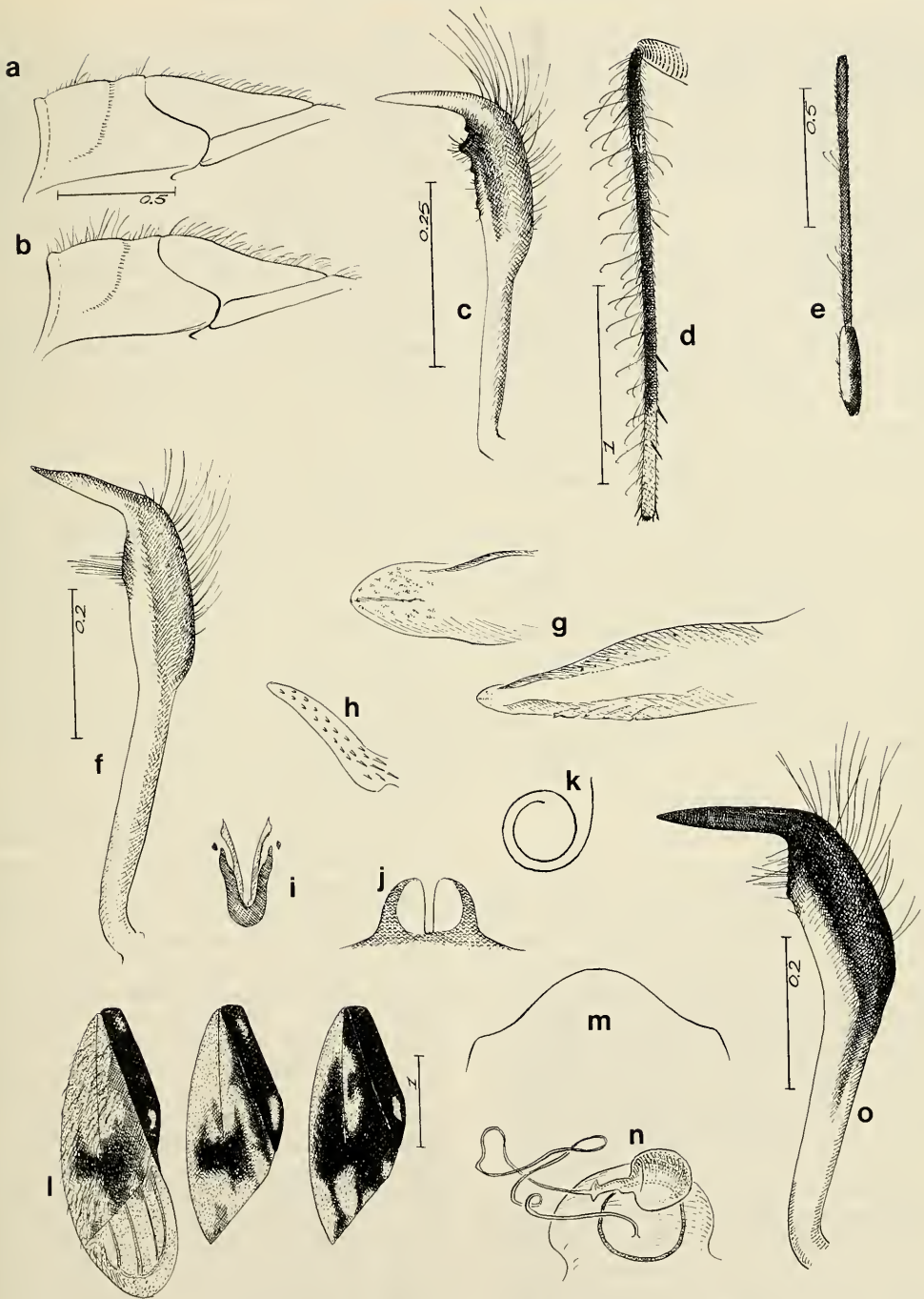

Fig. 6. a—c, *Macrosaldula* from Japan. a, *M. miyamotoi*, profile of pronotum and scutellum; b, idem of *M. shikokuana*; c, *M. miyamotoi*, paramere; d, e, hind tibia and antenna of *M. shikokuana*, respectively. f—n, *Saldula sibiricola*. f, paramere; g, apex of paramere; h, grasping plate of ♂; i, median endosomal sclerite; j, paramere; k, base of penisfilum; l, pigment variation of fore wing; m, outline of subgenital plate of ♀; n, gynatrium and spermatheca; o, *S. nobilis*, paramere.



0.2 mm long); ground colour testaceous, dark pigment brownish (variation, fig. 6l), three of the five specimens have a light proximal spot on the clavus; oblique hypocostal ridge present; membrane entirely light-coloured, basally with weak brown shade in dark specimens, veins light brownish.

Extremities: first two antennal segments shiny, yellowish, base of 1 sometimes darkened underneath, 3 and 4 black; segment 2 with obliquely extending brown pilosity, along the distal median side somewhat longer than diameter of segment, and with two dark, long setae medially at the middle (about 4 × longer than diameter of segment). Legs inclusive of coxae yellowish; flat sides of femora with some fuscous spots, apex of tibiae and last tarsal segment infuscate; short lightish pubescence, dark spines of third tibiae as long as diameter of tibia.

Other structures: abdomen dark brown, apex of sternites very narrowly pale; stigmata close to lateral margin of sternites; larval organ absent; distal prolongation of subgenital plate of female semicircular, whitish; male grasping plate, parandria, paramere and penisfilum as figured (fig. 6f—k, m, n).

Holotype (♂), length 4.3 mm, width 2.1 mm. Length and width of 3 submacropterous ♀ varying from 4.5—5.7 and 2.3—2.7 mm, respectively; of 1 macropterous ♀ 5.15 and 2.2 mm.

Material. — Holotype (♂), USSR, Transbaicalia, Kokuy, about 180 km ENE of railway station Urulga, 18.vi.1909, leg. A. Keller (in coll. Leningrad). Paratypes: idem 1 ♂ 1 ♀ (in coll. Wageningen); mountains SW of railway station Koptuma, Dzhungarski Alatau Mts, Kazakhstan, forest gorge, 1 macropterous ♀, 26.vi.1962, leg. G. Medvedev; 25 km ESE of Andreevka, Dzhungarian Alatau Mts, Kazakhstan, in a narrow forest along river, 1 ♀, 7.vii.1978, leg. I. Kerzhner; Otar, region of Verny (now Alma-Ata), 1 ♀, 29.vi.1922, leg. A. Reichardt; Temirtau, near Karaganda, 1 ♀, 11.vii.1961, leg. Asanova; river Tentek near Ursh-Aral, 1 ♂ 1 ♀, 9.vii.1978, leg. I. Kerzhner.

Comparative notes. — There are no clear-cut morphometric differences between *S. sibiricola* and *S. nobilis* (the paramere of *S. sibiricola* could be studied in only one ♂ available). The wing patterns are, however, so strikingly different that I am convinced, from my experience with other sibling complexes revealing fewer differences (Cobben, 1960, 1961, 1980a, b), that in the present case we are confronted with two reproductively isolated populations. I have seen

typical *S. nobilis* from Germany, Csechoslovakia, USSR, China and Japan. The material seen from Asia is as following (see map 1). USSR: Verkhnaya Mol'ka, Balagansk steppe, Irkutsk region, 1 ♂, 21.viii.1931, leg. Zakhvatkin; Igirma, Irkutsk region, 1 ♀, 17.viii.1966, leg. Zherikhin; Khabarovsk, 1 ♀, 18.vii.1931, leg. V. Pereleshina; Khabarovsk-Ussuri region, 1 ♂, 1.vii.1977, leg. K. Hürka; idem 3 ♂ 3 ♀, 3.vii.1977, leg. Štys & Davidová; idem 1 ♀, 8.vii.1977, leg. K. Hürka; idem, 3 ♂ 1 ♀, 1.vii.1978, leg. Štys & Vilímová; Mongolia, Batširet, 1 ♀, 7.viii.1974, leg. A. Seifert. China: Manchuria, 1 ♀, 25.vii.1943, leg. E. Kawase. I added on map-1 one locality in the Amur region and one in China (Kuku-nor lake); this material in the Leningrad collection has been checked by dr. Kerzhner (in litt.). Japan (new country record, formerly published as *S. scotica* Curt. by Hiura, 1967): Hokkaido, Kiyokawa near Ashoro, 2 ♂ 2 ♀, 7.vii.1958, leg. S. Miyamoto; Kutyaroko, 1 ♀, 11.viii.1937, leg. S. Asahina; Bekkai-mura, 1 ♀, 2.viii.1967, leg. T. Saigusa; Ataruma-dake, 1 ♀, 11.viii.1967, leg. A. Nakanishi.

Most of the material is semibrachypterous, some are submacropterous. The question of the status of *S. reuteri* Jak. must be considered here briefly. Jakovlev described this species from Siberia in 1889 without reference to *S. nobilis* described by Horváth five years earlier. Part of the type series of *S. reuteri*, available to me by the courtesy of Dr Kerzhner, conforms exactly with *S. nobilis*. *S. reuteri* was treated as a variety or a synonym of *S. nobilis* by most subsequent authors such as Drake & Hoberlandt (1951), Lindskog (1975), Vinokurov (1979a, b, c), but listed again as a species propria by Hoberlandt (1971b) from Mongolia without further comments.

All specimens of *S. nobilis* have a uniform, contrasting black-white wing pattern. The proximal basis of the clavus is black; rarely there is a very small white spot in the edge bordering the corium (just the opposite side in *S. sibiricola*, fig. 6i). The distal large white spot of the exocorium, which persists in all specimens of *S. nobilis*, presents a striking resemblance to *Telolencu pellucens*. In contrast, the light colour of the corium of *S. sibiricola* is testaceous and the brown pigmentation is only vaguely indicated (fig. 6i). I dare to predict that specimens with darker patterns than drawn in fig. 6i, right, will eventually be found, and that their distal endocorial spot will be much more reduced than in *S. nobilis*.

The conclusion that *sibiricola* is a valid species and not just an ecotype, is further strengthened by the fact that the eight specimens originate from five different localities within an area of roughly 1200 km<sup>2</sup> between 70–95° longit., 55–40° latit. (see map 1). Its range is more or less surrounded by that of *S. nobilis* which extends from western Europe to eastern USSR and Japan. Although this distribution pattern suggests vicariance between both species, Dr Kerzhner wrote me that *S. sibiricola* apparently is a lowland species, in contrast to *S. nobilis*. All records of the new species originate from steppe or even semidesert regions outside the true mountainous regions, mostly at

altitudes between 100 and 400 m. *S. sibiricola* might be more thermophilous than *S. nobilis* which prefers damp situations at higher altitudes.

**Macrosaldula clavalis** sp.n.  
(fig. 7a–e)

Description. — For measurements, see table 1. Moderate size (4–5 mm), without erect long setae, pronotum with pale side margins, clavus with lightish basal stripe, wings extensively marked with light pattern, close resemblance to *M. kaszabi* (Hoberlandt, 1971). USSR.

*M. clavalis* sp.n. and *M. kaszabi* (Hoberlandt) can be distinguished as follows.

	<i>clavalis</i>	<i>kaszabi</i>
length of antennae in relation to width of head	2.2–2.3 ×	2 ×
ratio length antennal segments 3 + 4 to that of 2	1.25–1.4	1.2
ratio pronotum width/length	3.0–3.2	2.7
head and pronotum	shiny	dull
pubescence	short, not dense, golden	rather dense, silvery
mouthpart sclerites of ♀	predominantly dark, only mandibular plate and apex of anteclypeus lightish (fig. 7d)	lightish
wing margin	partly dark	entirely lightish
inner base of clavus	with longitudinal pale stripe (fig. 7a)	without basal stripe
tibiae	dark coloured except for subapical ring	lightish except for dark base and apex

Material. — Holotype (♂), USSR, Transcaucasia, Tshakvis-tavi, Adzharia, 15–20 km NE of Batumi, 21.vii.1949, leg. Kiritshenko (in Leningrad coll.). Paratype ♂, idem (in Leningrad coll.), 1 ♀, idem (in coll. Wageningen).

Comparative notes. — Both the new species and *M. kaszabi* (Hoberl.) share a pale dot at the origin of the middle cephalic trichobothria, pale acetabula and pale pronotal side margins. The gular plate of *M. clavalis* ♂ is of light colour. The paramere of *M. clavalis* has a longer processus hamatus (fig. 7b, e) than in *M. kaszabi* as figured by Hoberlandt (1971 b, figs. 10, 11). The type locality of the new species in Georgia is about 4500 km west of the range of *M. kaszabi* in Mongolia. The differences with other *Macrosaldula* appear from the key to *Macrosaldula*

species presented below. Comments on the generic status of *Macrosaldula* are presented following the description of the next species, and on page 254.

**Macrosaldula inornata** sp.n.  
(figs. 8, 9 i–n)

Description. — For measurements, see table 1. Medium-sized (4.3–5 mm), slender, full-winged, short-haired, predominantly straw-yellowish, facies superficially *Pentacora*-like (fig. 8). Iraq.

Head: black, weakly shining, with recumbent silvery hairs; postclypeus, frons and vertex with ocelli flat; transverse swelling broadly developed above insertion of antenna; preocellar and frontolateral spots, border of upper notch of eye, transverse swelling, anteclypeus (except



Fig. 7. a—e, *Macrosaldula clavalis*. a, corium and clavus of left fore wing; b, apex of paramere; c, male grasping plate; d, front view of head; e, paramere. f—k, *Macrosaldula koktsbetavica*. f, paramere; g, base of penisfilum; h, median endosomal sclerite; i, rudiment of larval organ; j, parandria; k, pigment variation of corium and clavus. l, *Macrosaldula oblonga*, pigment variation of wing.



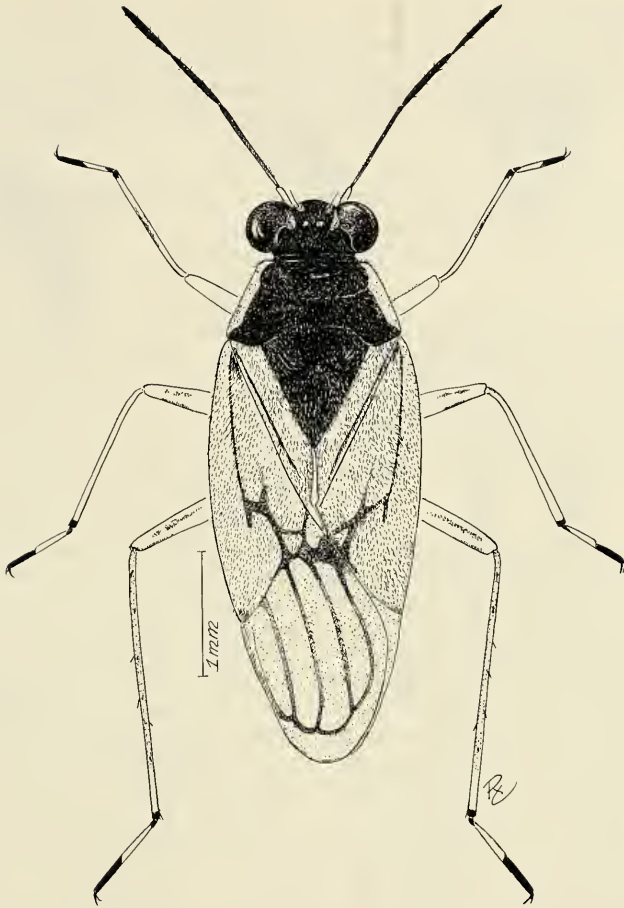

Fig. 8. *Macrosaldula inornata*, holotype ♂.

base), maxillary plate, gula and labrum yellowish; first visible segment of rostrum light, remainder dark brown, extending to middle coxae. Thorax: nearly dull, densely covered with recumbent golden pilosity dorsally and medium-long silvery hairs ventrally; pronotum trapezoid, with pale lateral margins, dome rather flat; acetabula light.

Wings: dull, with rather regular short, silvery pubescence, corium and clavus nearly unicolorous straw-yellowish, membrane slightly smoky; eight specimens have the lightest pattern as shown in fig. 8; in two males the dark design on the corium is only little enlarged, but the pale clavus tends to be broken up by pigment transversally in the middle; hypocoastal lamina narrow, without oblique ridge; area of wing margin of female serving for attachment of male grasp-

ing plate nearly imperceptibly differentiated; hind wing nearly as long as forewing.

Extremities: antennae slender, only with very short hairs (except for the erect ones on 3rd and 4th segment); segment 1 stout, yellowish, 2 light brown, 3 and 4 dark brown; legs straw-yellowish, with brown patches as in fig. 8, coxae black with light apex; legs with very short silvery pubescence, spines on last tibia brown, not longer than diameter of tibia; tibia 3 weakly curved inwards.

Other structures: abdomen dark brown, distal margin of sternites light; rudiment of larval organ and sclerite of pregenital gland present; stigmata close to but not touching side margins of sternites; subgenital plate of female with black base and white, truncate distal prolongation (fig. 9k); ovipositor with eight teeth (fig.

9l); spermatheca asymmetrical, piriform; spermathecal duct gradually expanding and opening into spermatheca without a flange (fig. 9n). Male grasping plate with some 25 semi-long pegs; male genital structures as depicted in fig. 9i, j, m.

Holotype ♂, length 4.3 mm, width 1.7 mm. Length and width of 4 ♂ 4.3—4.5 mm and 1.7—1.8 mm, of 5 ♀ 4.7—5.0 mm and 2.0—2.1 mm.

Material. — Holotype (♂), Iraq (Sept.), Prov. Mosul, near Agra, Salta-ravin, 24.vi.1958, leg. R. Remane. Paratypes 4 ♂ 5 ♀, idem. Holotype and paratypes in coll. Wageningen, paratypes in Remane coll., Marburg, BRD. The species was collected together with *M. variabilis variabilis* (H.-S) in the same habitat: stones in and along mountain-river (altitude between 600 and 1000 m).

Comparative notes. — Reuter (1895, 1912) was the first to recognize a *scotica* species-group within *Acanthia* (= *Saldula*), which possibly might deserve the status of subgenus. He included in this group *S. jakovleffi*, *oblonga*, *rivularia*, *scotica*, *variabilis* and, with some reservation, *koreana* and *mongolica* not seen by him. To this group I added a new species from Spain (Cobben, 1959), characterizing the species-group by stout body dimensions, proportionally long antennae and the same type of median sclerotized structure of the penis. The taxon *Macrosaldula* was first informally introduced as a subgenus by Southwood & Leston (1959) in order to separate *S. scotica* (Curtis, 1833) from typical *Saldula* species, and formalized as such some years later (Leston & Southwood, 1964). The subgenus *Macrosaldula* subsequently was given generic rank by Wroblewski (1968) and Polhemus (1977). However, the antennal ratios given by Leston & Southwood to distinguish *Macrosaldula* from *Saldula* species are not at all exclusive, and certainly they are not exclusive from other genera. Awaiting a critical analysis of generic groupings (Cobben, in prep.), I provisionally follow the usage of recognizing a *Macrosaldula* clade, inclusive of the lapidicolous *M. inornata* described above. Although aberrant in the paucity of dark pigment, it shares with other *Macrosaldula* species the shape of the median endosomal sclerite (fig. 9j) and has the following plesiomorphous conditions in common: male grasping plate with oblong pegs and hairs, absence of the secondary ridge on the hypocostal lamina and absence of the spermathecal flange.

Lindskog (1975) suggested that also the Nearctic *Saldula andrei* Drake (= *S. azteca* Drake & Hottes) and *S. nigrita* Parshley belong in the *Macrosaldula* group, but these species do not reveal the combination of characters given above.

### *Macrosaldula kerzhneri* sp. n.

(fig. 10a, b, d—i, n)

Description. — For measurements, see table 1. Stout (5.9—7.2 mm), rather dull, erect semi-long pubescence, predominantly black with narrow testaceous seam along lateral wing margin (fig. 10i, n). USSR, Kazakhstan.

Since the general facies resembles a number of other dark-coloured species, only some main characteristics are mentioned here. The testaceous wing margin (fig. 10i, n) separates this species from all other congeners. The semilong setae (length subequal to diameter of hind tibia) on the wings and scutellum are dense, on head and thorax sparse. Dorsum in addition with a regular coat of short decumbent silvery hairs. All mouth sclerites entirely (♂) or partly (♀) yellowish. Antennae and legs predominantly blackish or dark brown, light-dark pattern as in most other species; first antennal segment of ♂ testaceous on inner side. First acetabula entirely and second and third apically yellowish. Male genital structures as drawn in fig. 10a, e—h. Male grasping plate with about 20 elongate pegs and some stiff setae medially (fig. 10b).

Material. — Holotype (♂), S. Kazakhstan, 20 km N of Kentau, Karatau Mts, 27.v.1966, leg. Arnoldi (in coll. Leningrad). Paratypes, 2 ♀, idem, 26.v.1966, leg. Kerzhner; 1 ♀, 24.v.1966, leg. Gurjeva; 1 ♀, Atshisay, river Teresakan, Karatau Mts, 31.v.1936, leg. Lukanovitch. For the location of sampling sites, see map 2.

Comparative notes. — The wing pattern with the neatly parallel ochreous costal margin and the pale first acetabula separates *M. kerzhneri* from other species with a more or less dense pubescence. To these belong *M. scotica*, *madonica* and *tadzhika* in which, moreover, the setosity extends laterally beyond the pronotal margin. The paramere without distinct processus sensu-alis and slender, sharp processus hamatus (fig. 10e, f) and the male grasping plate with two rows of pegs (fig. 10b) differs from those in *M. scotica* (fig. 10j—m and 10c). Further differences between *M. kerzhneri* and all other related species can be extracted from the key to *Macrosaldula* species.

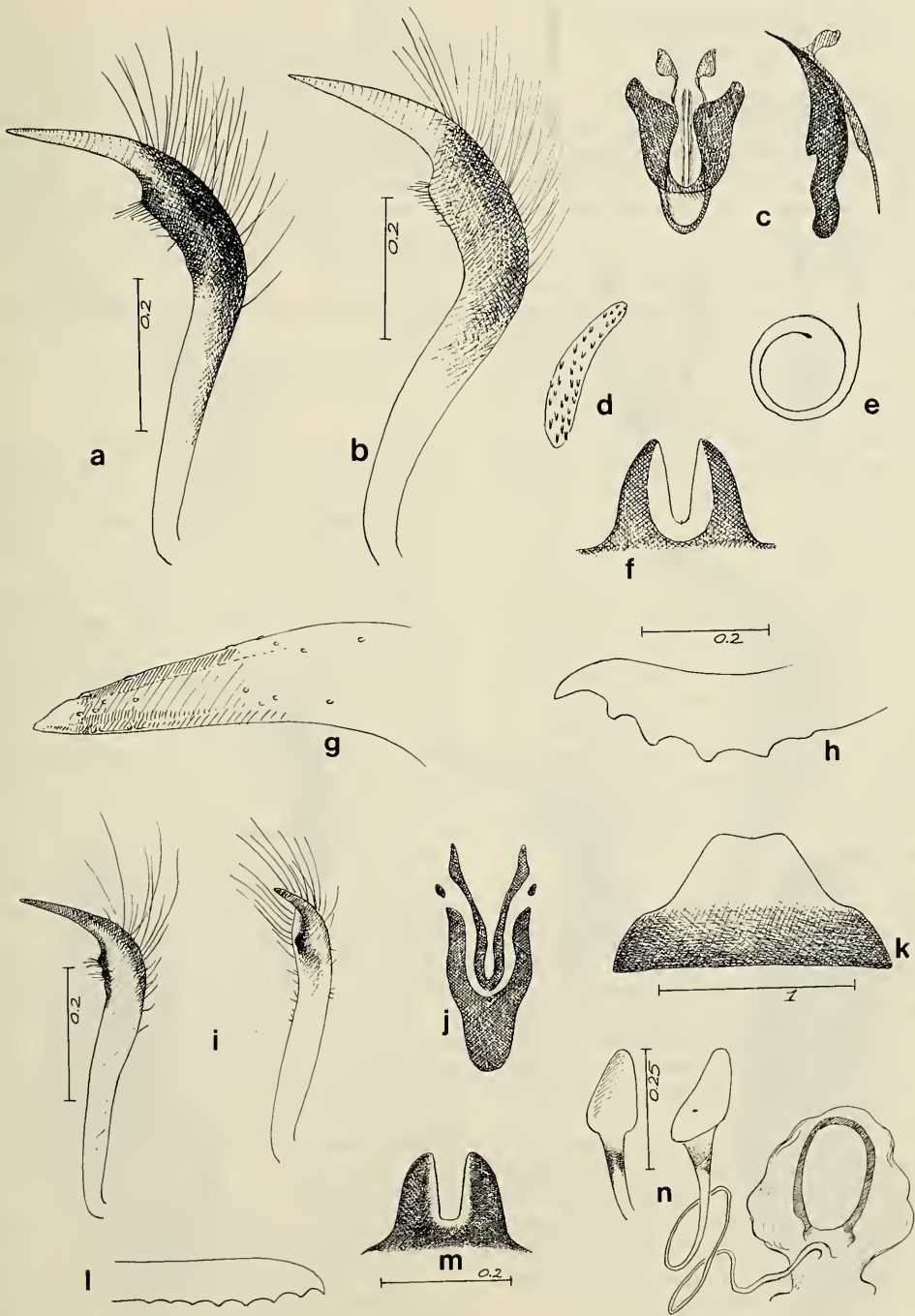

Fig. 9. *Macrosaldula* species. a—h, *M. koreana*; a, b, paramere; c, plane and side view of median endosomal sclerite; d, grasping plate of ♂; e, base of penisfilum; f, parandria; g, apex of paramere; h, sawing blade of ovipositor. i—n, *M. inornata*. i, paramere, plane side and inner view (right); j, median endosomal sclerite; k, female subgenital plate; l, sawing blade of ovipositor; m, parandria; n, gynatrium with ring gland and spermatheca.



**Macrosaldula koktshetavica** sp.n.  
(fig. 7f—k)

Description. — For measurements, see table 1. Medium-sized (4.3—5.5 mm), full-winged, weakly shiny, yellowish brown, exocorium, legs and acetabula predominantly light-coloured, with short adpressed and semilong erect pubescence. USSR, Kazakhstan.

Head: black, weakly shiny, sparse silvery pubescence, several erect dark setae on frons and vertex in addition to the six trichobothria; pre-cellular spot, mouth sclerites and gula yellowish in both sexes; rostrum dark-brown, except for first short visible segment, extending in between middle coxae. Thorax: black, shiny, with rather dense silvery or golden pubescence and scattered semi-erect, semilong setae; first acetabula broadly and other acetabula narrowly margined with pale colour.

Wings: weakly shiny, pubescence as on thorax; colour pattern not very contrasting, eunomy as in fig. 7k (based on 38 specimens); the spreading of dark pigment starts from the exocorium, but the edge of the outer wing margin is always narrowly brown even in the pale specimens; in the lightest extreme the inner base of the clavus bears a narrow pale spot; the dark extreme approaches the general wing pattern of *M. oblonga* (fig. 7l); membrane for the major part light-greyish, also in darkest specimens, veins light-brown; hypocostal lamina narrow, without oblique ridge.

Extremities: first segment of antennae black ventrally, yellowish dorsally, other segments dark brown, the very base of second lightish; pubescence very short, all segments with some erect semilong dark setae. Legs predominantly yellowish, underside of femora dark brown, flat sides with some fuscous spots, apex of tibiae and last tarsal segment brownish, pubescence very short, dark spines of hind tibia almost as long as diameter of tibia.

Other structures: abdomen brown, distal margin of sternites lightish; distal prolongation of subgenital plate of female truncate, white. Male grasping plate with short pegs and spinous setae in the median edge. Base of penisfilum with nearly two coils (fig. 7g). Parandria, paramere, and endosomal sclerite as in fig. 7j, f, h.

Holotype (♂), length 4.3 mm, width 1.9 mm. Length and width of ♂ varying from 4.3—4.7 and 1.8—1.9 mm, respectively; of ♀ from 5.0—5.5 and 2.1—2.3 mm, respectively.

Material. — USSR, holotype (♂), Borovoe, Koktshetav region, Kazakhstan, 27.vi.1932, leg. V. Popov (in coll. Leningrad). Paratypes: 5 ♂ 17 ♀, idem; between Stshutshinsk and Barmashi, Koktshetav region 8 ♂ 9 ♀, 4 larvae, 23.vi. and 1—2.vii.1982, leg. Filipyev (in coll. Leningrad, coll. Wageningen). Additional 50 specimens, not seen by me, from both localities are in the Leningrad Museum. Dr Kerzhner informs me that the Koktshetav Hills form an isolated mountain-massive in North Kazakhstan, surrounded by steppes and covered by birch and pine forests.

Comparative notes (see key to *Macrosaldula* species).

**Macrosaldula miyamotoi** sp. n.  
(fig. 6a, c; 14 f)

Description. — For measurements, see table 1. Medium-sized (4.4—5.7 mm), slender, macropterous, predominantly black with short and semilong pilosity, corium mostly with rather contrasting yellowish markings (fig. 14f), membrane dark smoky. Japan.

Head: black, with erect black setae somewhat shorter than trichobothrial setae; lightish pre-cellular spots large, broadly touching eye and nearly extending to ocellus; mouthpart sclerites yellowish in male, base of anteclypeus, median part of transverse swelling and margins of labrum darkish, in female maxillary plate in addition black; gula black; rostrum dark brownish, reaching hind coxae. Thorax: shiny black with sparse short adpressed golden pubescence, in addition dorsally with erect semilong and a few long dark setae (fig. 6a), which extend from straight lateral margin of pronotum; acetabula black, rarely with light margin.

Wings: scattered short golden setae, numerous dark erect semilong setae with curved apex; eunomy of weakly shining forewings as depicted (fig. 14f); yellowish spots rather contrasting with black ground-colour (less in specimens of Ohshimizu), dark area of distolateral part of endocorium deeply black; pale stripe in proximal base of clavus rarely present; membrane predominantly fuscous also in light-coloured individuals.

Extremities: Antennal segments dark, first segment medially with pale line, 2 with short setae. Legs predominantly dark-coloured, pubescence short; trochanters, upper and underside of femora and often subapical ring of tibiae and second tarsal segment lightish.

Other structures: caudal extension of female subgenital plate truncate, white; paramere as in fig. 6c.

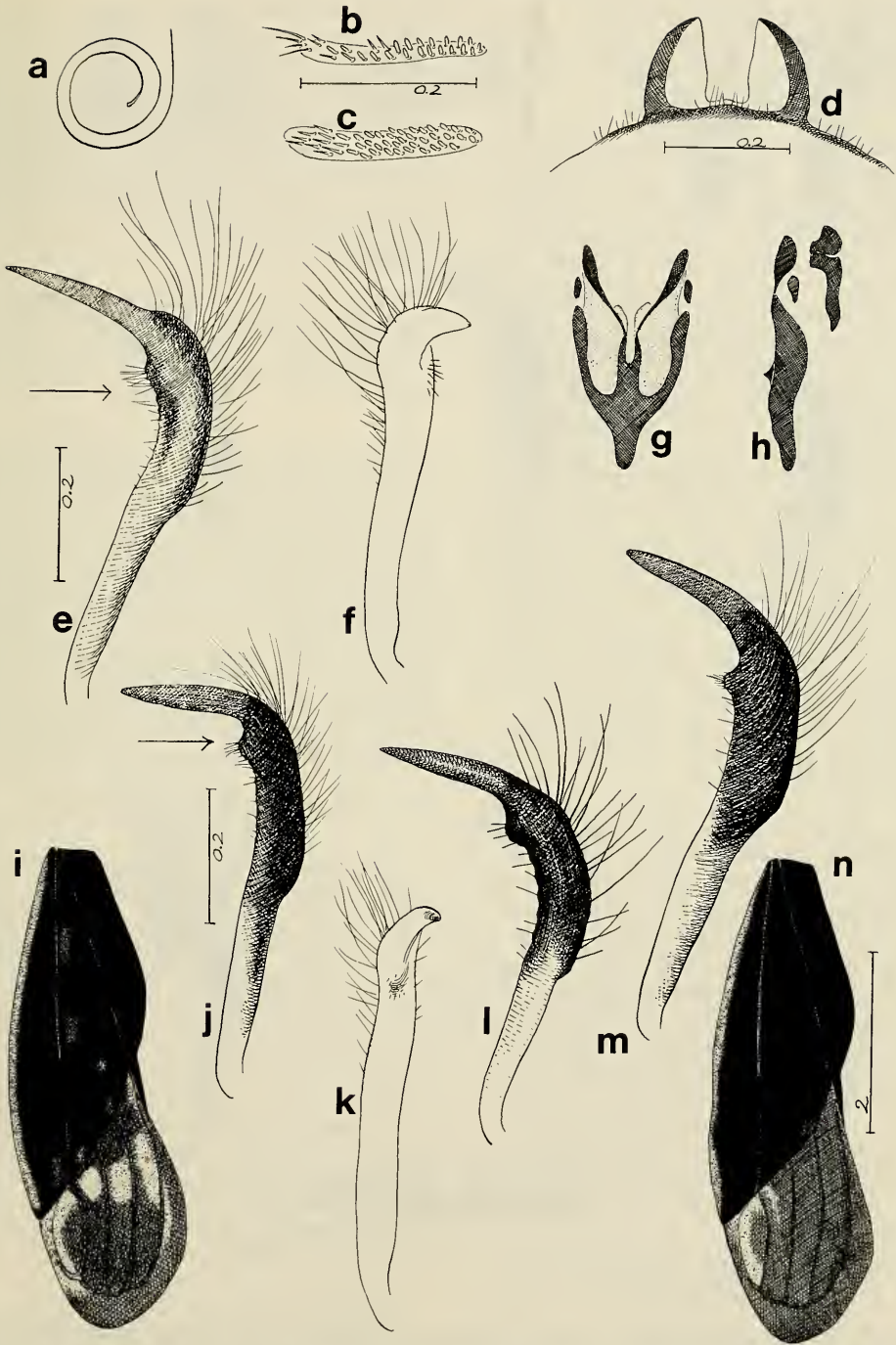

Fig. 10. *Macrosaldula*. a, b, d—i, n, *M. kerzhneri*. a, base of penisfilum; b, grasping plate; d, parandria; e, f, paramere, f, viewed in direction of arrow in fig. e; g, h, median endosomal sclerite, plane and lateral view, respectively; i, n, left fore wing. c, j—m, *M. scotica*. c, grasping plate; j—m, parameres of specimens from the Netherlands (j, l) and Austria (m).



Holotype ( $\delta$ ), length 4.9, width 1.9 mm. Length and width of 12  $\delta$  varying from 4.4—5.0 mm and 1.9—2.0 mm, respectively; of 8  $\eta$ : 5.3—5.7 and 2.3—2.5 mm.

Material. — Holotype ( $\delta$ ), Japan, Honshu, Nagano Pref., Kamikochi, 10.ix.1951, leg. H. Hasegawa (in coll. Wageningen). Paratypes: Idem 1  $\eta$ ; Honshu: Nagano Pref., Todai, S. Alps, 1  $\delta$  1  $\eta$ , 12—14.viii.1978, leg. M. Satô; Gifu Pref. Oppara, 9  $\delta$  3  $\eta$ , 15.vi.1978, leg. M. Satô; Meoto waterfall, Takasu Village, 12  $\delta$  3  $\eta$ , 11.viii.1980, leg. J. T. Polhemus & M. Satô; Okumino, Hirugano Heights, 5  $\delta$  1  $\eta$ , 12.viii.1980, leg. J. T. Polhemus & M. Satô; Izu Peninsula, Nikai-daru Falls, 5  $\delta$  3  $\eta$ , 29.ix.—3.x.1980, leg. M. Tomokuni; Izu Peninsula, Yagashima-cho, Kanogawa River, 4  $\delta$  5  $\eta$ , 3.x.1980, leg. M. Tomokuni; Miyagi Pref., Futakuchi, Natori-gun, 1  $\eta$ , 20.viii.1977, leg. M. Tomokuni, Toogatta, 1  $\eta$ , 19.viii.1977, leg. M. Tomokuni; Shosenkyo Kai, 1  $\delta$  1  $\eta$ , 11.viii.1959, leg. S. Miyamoto; Yamanashi Pref., Masutomi, 1  $\delta$ , 25.vii.1963, leg. T. Saigusa; Gumma Pref., Oze, 3  $\delta$  2  $\eta$ , 5.ix.1952, leg. H. Hasegawa; Ohshimizu, Oku-Nikko, 3  $\delta$  4  $\eta$ , 18.vii.1940, leg. M. Hanano; Kyushu: Chikushi-Yabakei near Fukuoka, 2  $\delta$ , 30.ix.1956, leg. S. Miyamoto; Ino near Fukuoka, 1  $\delta$  2  $\eta$ , 14.vii.1965, leg. S. Miyamoto; Fukushima, Chikugo, 1  $\delta$ , 26.viii.1952, leg. S. Miyamoto; Fukuoka, Chinugo, 1  $\eta$ , 6.vii.1952, leg. S. Miyamoto; Yakushima, Miyanoura, 1  $\delta$ , 29.viii.1953, leg. Takeya & Hirashima. (Paratypes in coll. of Hasegawa, Miyamoto, Polhemus, Jap. Nat. Museum, Kyushu Univ. and in coll. Wageningen).

Comparative notes. — This species is apparently widely distributed along stony banks of rivers on the southern main islands of Japan. The lightest coloured specimen (fig. 14f) comes from Yakushima, a small island close to the southern coast of Kyushu. Colour-intermediates with dark coloured specimens occur without any morphological differences on Honshu. *M. miyamotoi* and the related *M. shikokuana* from Japan, described below, are close to continental *Macrosaldula* species of the *oblonga* group. Their economy, however, is marked by the absence of the light spot on the proximal part of the endocorium, even in the palest specimens (compare fig. 14f with figs. 7i, 14d, e).

***Macrosaldula oblonga acetabularis* subsp. n.**  
(fig. 12f)

Separable from the nominate form *oblonga* Stål, 1858, by the entirely whitish first acetabula (always black in the long series of typical *oblonga* which I have seen). In two of the four specimens of the new subspecies the second ac-

etabula have a pale margin. The ratio length antenna/width pronotum in two males of subsp. *acetabularis* is 1.64—1.74, and in 10 males of subsp. *oblonga* 1.85—1.90. These ratios could not be checked for females, since the single female of *acetabularis* has incomplete antennae. The parameres of two males of the new subspecies have a straight processus hamatus (fig. 12f), whereas this is slightly curved upwards in subsp. *oblonga* (fig. 12a).

Material. — 3  $\delta$  1  $\eta$ , Zaisan, river Karasu, E. Kazakhstan 20.vi.1965, leg. J. Sukatsheva (holotype  $\delta$  in Leningrad coll., others in Popov coll. (Moscow), coll. Wageningen). This subspecies was collected simultaneously with *M. jakovleffi* Reut.

Comparative notes. — The locality of this subspecies is about 500 km outside the presently known range of the nominate form (see map 2). The distribution pattern of *M. oblonga oblonga* covers the mountainous regions of Mongolia and Transbaical between 90 and 118 degrees of longitude, that is about 2000 km. The altitude of the type locality of *M. oblonga acetabularis* west of this range is not mentioned, but it may be lower than where the nominate form occurs. According to Hoberlandt (1971b), the occurrence of the nominate subspecies in Mongolia is between 1200 and 2100 m.

***Macrosaldula shikokuana* sp. n.**  
(fig. 6b, d, e)

Very similar to *M. miyamotoi* in dimensions (table 1) and coloration, differing only in the much longer pilosity. Second antennal segment with a few erect semilong setae along the median side (fig. 6e). Erect hair-dress on dorsal side more conspicuous and somewhat longer than in previous species (fig. 6b), laterally extending over a distance of 0.23 mm beyond the margin of the pronotum. Tibiae with silvery adpressed pubescence and erect brown setae which are longer than the diameter of the tibia; the distribution and length of these curled setae on the hind tibiae are indicated in fig. 6d. The male paramere is much like in *M. miyamotoi* (fig. 6c). The wing patterns of the holotype and paratype are more or less like fig. 14f, right.

Holotype ( $\delta$ ), Japan, Shikoku, Omogo, Iyo, 14.vii.1952, leg. T. Ishjara & S. Miyamoto. Paratypes: idem, 3  $\delta$  3  $\eta$  (holotype and paratypes in Jap. National Museum, Tokyo; paratype in Polhemus coll., Englewood).



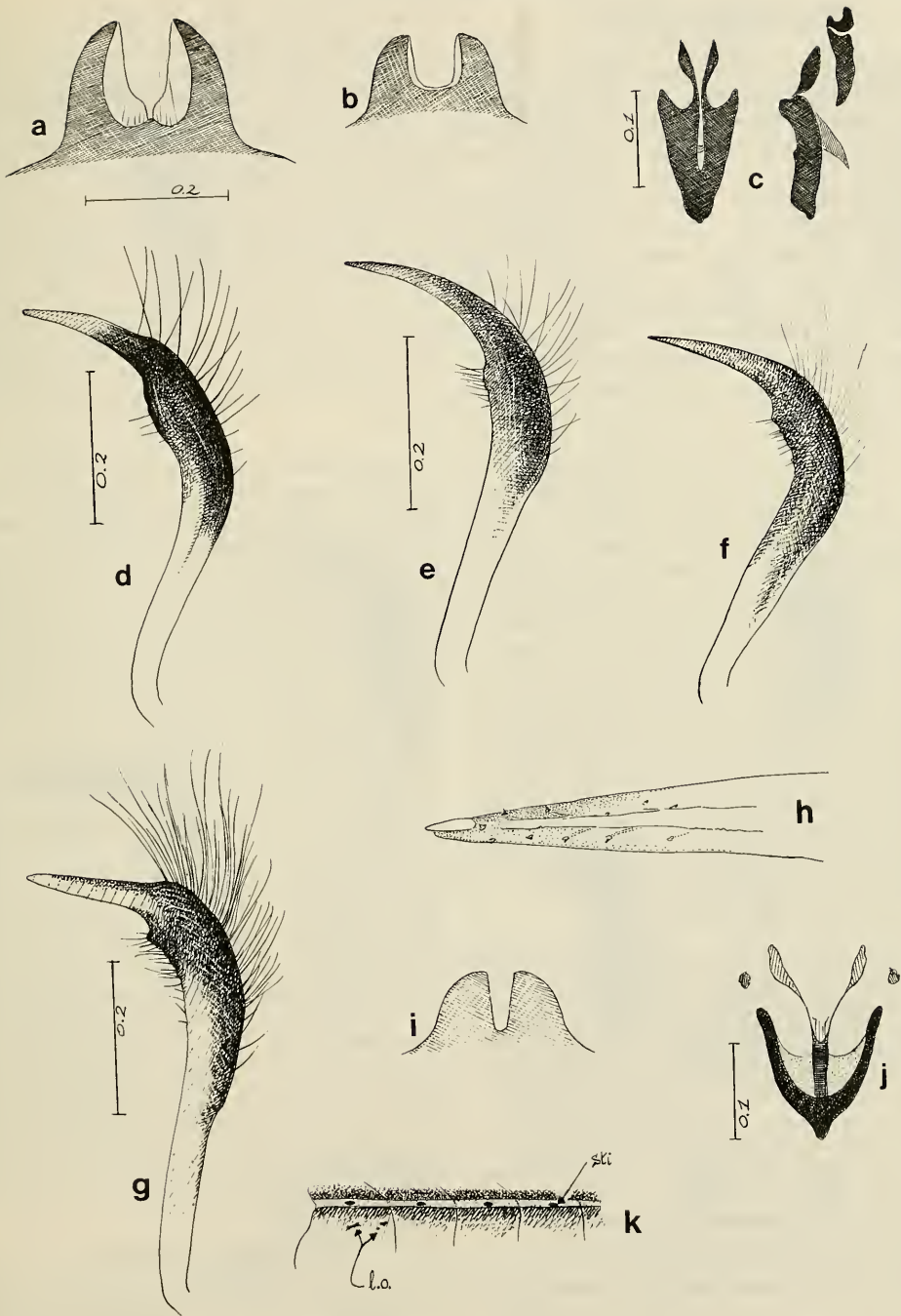

Fig. 11. *Macrosaldula* species. a, *M. simulans*, parandria; b, *M. rivularia* from Mongolia, parandria; c, idem, left, median endosomal sclerite, plane side; right, left view of median and lateral endosomal sclerites; d—g, parameres; d, *M. monae*; e, f, *M. rivularia*, Mongolia; h, apex of paramere of *M. rivularia* from Alaska; i—k, *M. violacea*; i, parandria; j, median endosomal sclerite; k, side view to show the placement of stigmata in between sternites and tergites.

**Macrosaldula simulans** sp. n.

(fig. 11a)

Description. — For measurements, see table 1. Stout (6.3—6.9 mm), unicolorous dullish black species with short silvery recumbent setae; very close to *M. rivularia*, Sahlb. East-USSR.

The most reliable distinguishing characters with *M. rivularia* are as follows: middle pair of cephalic trichobothrial setae not originating from light spot (such a spot is present in all specimens of *M. rivularia* I have seen from Siberia and Alaska, and also in the Alaskan *M. monae* Drake), and proportionally longer antennae and legs. The ratio antennal length/head width is 2.73—3.06 in *M. simulans* (n = 8) and 2.12—2.4 in *M. rivularia* (n = 8). The ratio length of third tibia/head width amounts to 2.55—3.03 and 1.91—2.21, respectively. These ratios could be influenced by allometry of the appendages because the new species is on the average larger (6.3—6.9 mm) than *M. rivularia* (4.4—6.5 mm). However, the discrepancies of the ratios between the two species remain as striking in specimens of equal size. *M. simulans* differs further weakly in having a somewhat more dull pronotum, dark anteclypeus (also in the male), inner side of first antennal segment weakly lightish in male, entirely dark in female. Genital structures are similar to *M. rivularia*, but the parandria of the holotype of *M. simulans* reveals a small median process (fig. 11a), which lacks in *M. rivularia* (fig. 11b). Additional material is needed to check whether this is a constant feature of difference.

Holotype (♂), USSR, river Buren, near Ilyinka (Bulun-aksky), (Tuva region), 14.vi.1949, leg. Pervezotshikova, in Leningrad Museum. Paratypes: USSR: 1 ♀, Krasnoyarsk, 3.viii.1924, leg. Vinogradov; 1 ♀, Kultuk, near Baikal Sea; 1 ♀, Tunka, along river Irkut, about 180 km W-SW of Irkutsk, 20.vii—10.viii.1911, leg. C. Ahnger, collection of Rodionov; 1 ♀, coast of Baikal Sea near Tolsty Mys, village Sukhoy, vii.1928, leg. Vereshchagin & Tikhomirov; 1 ♀, Baikal, delta of the river Selenga, near the Proval bay, 12.vii.1925, leg. Vereshchagin & Tikhomirov; 1 ♀, Kuznetsk basin (Kemerovo Prov.), river Suriyekovaya, 2.viii.1951 (in coll. Leningrad and Wageningen).

Additional material not seen by me.

After reading my manuscript Dr P. Lindskog wrote me that he had examined an apparently undescribed species from a collection of Saldidae from Mongolia, which appears to fit the description of *M. simulans*. The specimens concerned were attributed to *M. rivularia* by Hoberlandt (1971b); they were collected in a small mountain range in NW Mongolia, SE Uvs-

Nuur. The locality label reads as follows: Uvs Aimak, Somon Öndörchängaj, 1900 m, loc. 1090, 3 ♂ 2 ♀, 11.viii.1968, Exp. Dr Z. Kaszab, 1968. Dr I. Kerzhner tested my key and could trace additional material of *M. simulans* in the Leningrad Museum. These data, which are also plotted on map 2, are as follows: W. Siberia: Bayan-Ölgiy aimak, river Ikh-Dzhargalantyn-Gol, 20 km NW of Bulgan, 1 ♂ 2 ♀, 23—24.vii.1978, leg. Gurjeva; same aimak, river Dzhangyz-Agatsh-Gol, 15 km SE of Delun, 21.vii.1978, 6 ♂ 8 ♀, leg. Gurjeva; Bayan-Khongor aimak, river Tuin-Gol, 10 km S of Erdene-Tsogt, 7 ♂ 16 ♀, 25.viii.1978, leg. Gurjeva. Mongolia: Dzabkhan aimak, Dzegistay pass, 1 ♂, 23.ix.1926, leg. Kiritshenko (as *M. rivularia* in Vinokurov 1979b); Ara-Khngai aimak, confluence of Sumiyn-Gol and Tshulutyn-Gol, 5 ♂ 7 ♀ (together with *M. rivularia*), 29—30.vi.1975, leg. Gurjeva & M. Kozlov.

Comparative notes. — The distribution of this new taxon (see map 2) supports the view that *M. simulans* warrants the status of species, distinct from *M. rivularia*. The latter species has been recorded from Siberia (even from the extreme north near the delta of Enisey), Mongolia (Hoberlandt, 1971), and Alaska. I saw additional material of *M. rivularia* in the Leningrad collections from the following localities: Mountain Pektusan, North Korea, 10 spec., 21.viii.1950, leg. Borkhsenius; Omsuktshan, Kolyma, 1 ♀, 27.viii.1953, leg. Kurnakov; river Ebeten, 10 km SW from Kuysyur near Lena, Yakutia, 2 ♀, 10.vii.1957, leg. Gorodkov. Mongolia, Urga (Ulan-Bator), 7 spec., 4.vii.1926, leg. Kiritshenko; idem, 11 spec., 25.vi.1928, leg. A. Ivanov; Urga, coast of river Tola, a long series, 25.vi.1928, leg. A. Ivanov; Över Changai-aimak, Orchon waterfall, 2000 m, 1 ♂, 14.vii.1965, leg. Mucbe (labelled as *mongolica* Kir.). The presently known distribution of *M. rivularia* is shown on map 2. Future collections may perhaps reveal that the ranges of both species overlap partly. Within the genus *Macrosaldula*, *M. simulans*, *M. rivularia* and the Alaskan *M. monae* form a separate unit, characterized by a similar median endosomal penis sclerite (fig. 11c); this sclerite is more slender in all other *Macrosaldula* species (fig. 10g).

**Macrosaldula violacea** sp. n.

(fig. 11 i—k)

Description. — For measurements, see table 1. Rather large (5.2—7.0 mm), slender, more or less parallel-sided, glossy black with metallic-violet shine, wings inclusive of clavus and membrane entirely immaculate, antennae and legs predominantly dark brown, pubescence very

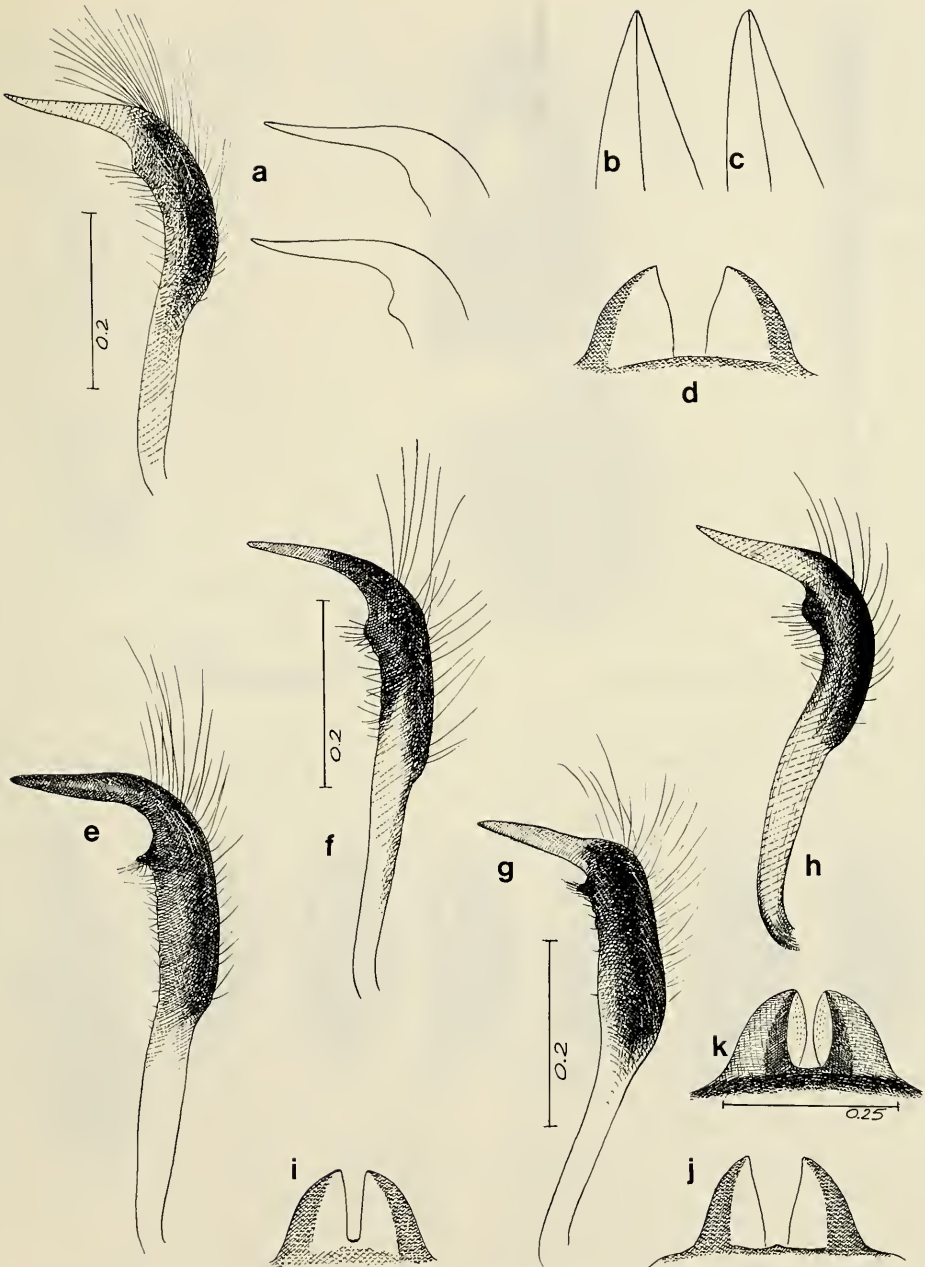

Fig. 12. *Macrosaldula* species. parameres (a, e—h), parandria (d, i—k), base of fore wing (b, c). a, d, *M. oblonga*; b, most *Macrosaldula* species; c, *M. variabilis*; e, i, *M. madonica*; f, *M. oblonga acetabularis*; g, k, *M. nivalis*; h, j, *M. jakovleffi*.

short and sparse. Far East of the USSR, Japan.

This unicolorous black species is very close to *M. koreana* (Kiritshenko, 1912a). The differences are tabulated as follows.

Alaska. This species is smaller (4.5—6.4 mm), rather dull, and bears a thick, somewhat shaggy, pubescence of semilong silvery hairs. The second dull-blackish species, *M. simulans*, has just



	<i>violacea</i>	<i>koreana</i>
size	in general somewhat smaller, particularly the material from Japan which ranges from 5.2—6.0 mm (n = 8)	in general somewhat larger, 6.3—7.3 mm (n = 20)
ratio pronotum length/width	2.7—3.0 (n = 5)	2.4—2.55 (n = 5)
ratio antennal length/head width	2.6—2.7 (n = 5)	3.0—3.1 (n = 5)
upper side	strongly shining, with blue-violet colour	less obviously shining, sometimes with faint bluish reflection
hair covering	short, less dense	slightly more dense (this character can only be evaluated by simultaneous comparison of both species)
colour	♂ inner side of first antennal segment, transverse swelling above anteclypeus, anteclypeus and maxillary plates yellowish ♀ all these parts black, transverse swelling and maxillary plate sometimes partly black	always entirely black, as in ♀ always entirely black, as in ♂
paramere	fig. 11g	regularly curved (fig. 9a, b)

Other less readily visible characters reveal a greater discrepancy between both species. Whereas the abdominal stigmata in *M. koreana* have a normal position on the sternites, those of *M. violacea* are located in the lateral connexival membrane (fig. 11k). The median endosomal sclerite of *M. violacea* (fig. 11j) resembles that of typical *Macrosaldula* species, while *M. koreana* fig. 9c) in this respect more resembles *M. rivularia* (fig. 11c).

Holotype (♂), Japan, Honshu, Izumi Tamagawa, Tokyo, 24.vi.1951, leg. H. Hasegawa (in coll. Wageningen). Paratypes: 8 ♂ 4 ♀, idem; Honshu, Onikobe, Miyagi, 1 ♂ 12.viii.1977, leg. T. Nambu; Hokkaido, Matsuneshiri, Nakatonbetsu, 12 ♂ 1 ♀, 26.viii.1977, leg. M. Tomokuni; USSR, 29 specimens, Vinogradorka, Primorskiy Kray, 9 and 14.vii.1929, leg. Kiritschenko; 1 ♀, river Sitsa (now Tigrovaya), Sutshan (now Partizansk) district, Primorskiy Kray, 18.vii.1926, leg. Rostovykh; 1 ♂, river Sudzukhe (now Kievka), 7.vii.1948, leg. Sharov. Paratypes in Leningrad coll., coll. Kyushu Univ., coll. Hasegawa, Linnavuori, Polhemus, and Wageningen.

Comparative notes. — Both *M. violacea* and *M. koreana* cannot be confused with other members of this genus. The only known entirely black species of the *Macrosaldula* group is *M. rivularia* (Sahlb., 1878) from Siberia and

been described above. So far the scarce data suggest (see map 1) that *M. violacea* may be distributed on the mainland and islands around the Sea of Japan. The continental localities all lie north of Korea. Of *M. koreana* I have seen additional material from localities at roughly 1500 km NW of Korea (coast of the river Shilka, Sretensk, Transbaicalia, 3—19.vii.1928, leg. Kapustin; of the large species in the Leningrad coll. I have studied 23 ♂ and 14 ♀). Other localities of *M. koreana* (1 ♀, River Koppi, 52 km W of Mouth, Sikhote-Alin Mts, 20.viii.1924, leg. Emelyanoc; 2 ♀, Imperatorskaya Gavan' (now Sovetskaya Gavan'), Khabarovsk region, 23 and 26.vii.1916, leg. N. Krylov) lie north of Korea and thus overlap the distribution of *M. violacea*. It is uncertain whether *M. koreana* occurs in Japan. Earlier records from Honshu (Hasegawa, 1960) may probably refer to *M. violacea*.

#### *Calacanthia grandis* sp. n. (figs. 15d, 17d)

Description. — For measurements, see table 1. Large (single ♀ measures 7.5 mm) with proportionally long antennae; dull, black with small testaceous wing spots, adpressed short lightish setae and some erect dark setae on head and pronotum; superficially resembling *Chilox-*

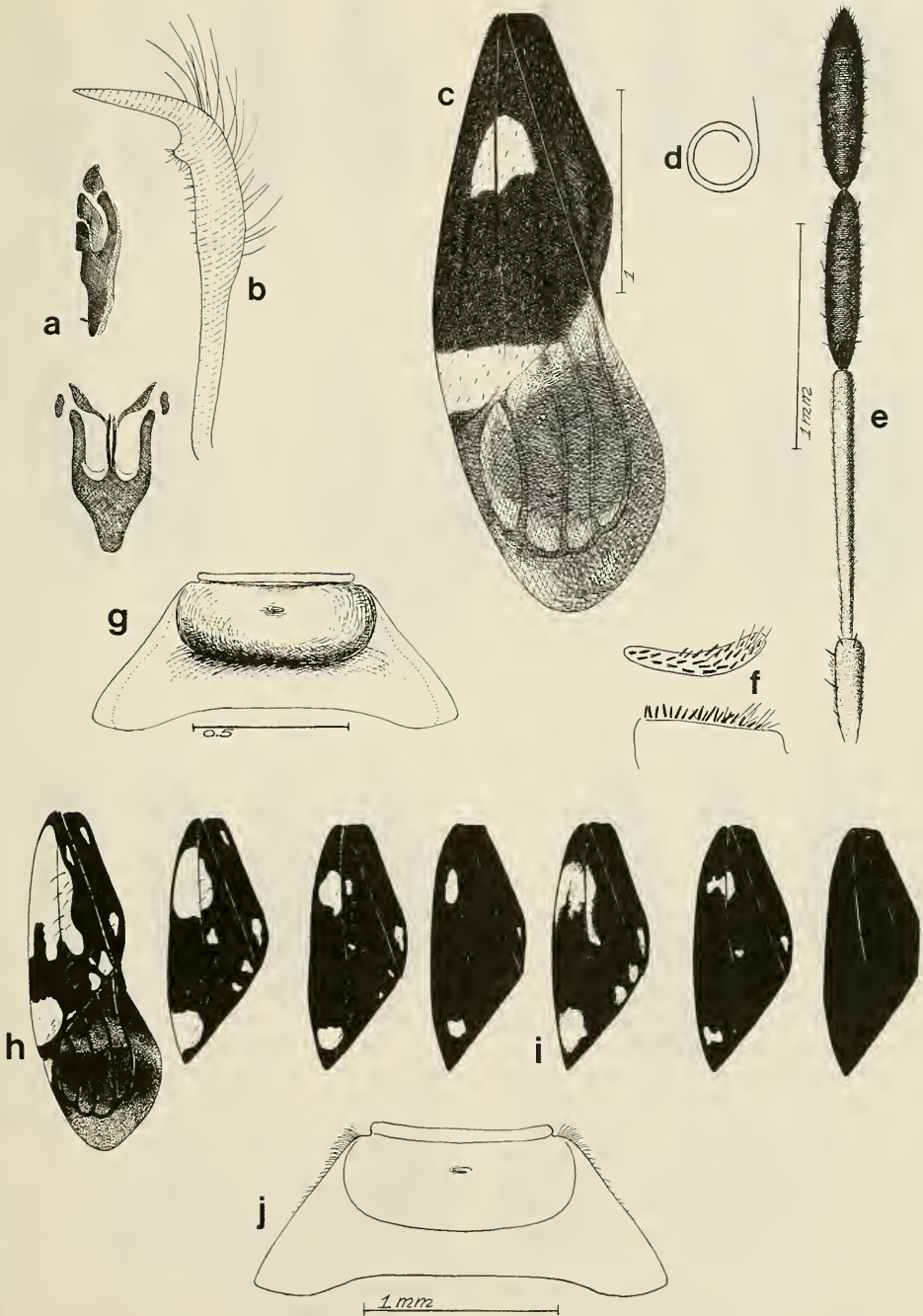

Fig. 13. a—g. *Macrosaldula roborowskii*. a, median endosomal sclerite, plane view (below), lateral view (above); b, paramere; c, left fore wing; d, penisfilum; e, right antenna; f, male grasping plate; g, pronotum. h, i, *M. variabilis*, enomy of left fore wing; h, *variab. connectens*; i, *variab. variabilis*. j, *M. jakovleffi*, pronotum.

*anthus* species from the Himalaya or large-sized dark *Macrosaldula* species. China.

Head: dull, black inclusive of mouth sclerites, basal half of labrum brownish; preocellar spot through narrow testaceous band along eye margin connected with pale spot bearing frontal trichobothrial setum; setosity short, golden, adpressed, and with scattered erect dark setae as long as the six trichobothrial-like setae. Thorax: Pronotum 2.6 times wider than long medially, side margins almost straight; frontal edges protruded laterad, much wider than pronotal collar; callus rather flat, not reaching side margins, central pit transverse, with smaller pit left and right, posterior lobe of pronotum medially half the length of callus; rather densely covered with short adpressed golden setae and with few erect dark setae; black, pronotal lateral margin very narrowly testaceous; acetabula 1 and 2 entirely lightish, 3 only apically.

Wing of single specimen macropterous (fig. 15d); exocorium subbasally foliaceous, somewhat wider than base of endocorium, hypocostal lamina well-developed, without secondary ridge; margin of wing slightly infolded at the small polished area which is adapted to receive the coupling plate of the male; corium dull, black with seven testaceous spots (fig. 15d), clavus entirely black; membrane ochreous, veins brown, cells with brownish markings; short silvery pubescence of corium moderately dense, somewhat shaggy.

Extremities: Antennae long, ratio of segments: 1 : 2.41 : 1.40 : 1.57; segment 2 cylindrical (♀), thickness 0.4 times diameter of segment 1; all segments dark-brownish, with short adpressed silvery setae, segment 1 in addition with semilong dark stiff setae along median side, segment 2 with some scattered semilong setae which are slightly longer than diameter of segment, erect setae on segments 3 and 4 approximately as long as the diameter of the segment. Legs: flat upper and under sides of femora largely dark-brownish, fore and back testaceous, with short silvery pubescence and scattered obliquely erect dark setae, also on front femur; base and apex of tibiae dark-brown, otherwise testaceous, tibia 1 with one dark ring in middle, tibiae 2 and 3 with series of dark patches, length of dark spines subequal to diameter of tibia; second tarsal segment yellowish, third segment brownish, ventral side of second tarsal segment of third leg with two rows of six spines. Genital structures of ♀, spermatheca piriform, with proximal flange (fig. 17d), teeth

of ovipositor blade sharply pointed (fig. 17f), apex of second gonapophysis tapering (fig. 17f above.)

Material. — Holotype (♀), China Balang, Wassuland, W. Szechwan, Sankiangkow, 7.viii.1934, leg. Friedrich (in Leningrad Museum).

#### Comparative notes on *Calacanthia*.

The genus *Calacanthia* is characterized by the flattened first and second antennal segment in the male (fig. 16d, e). Only three species have been assigned to this genus, viz., *C. trybomi* (Sahlb., 1878) and *C. alpicola* (Sahlb., 1880) from the northern arctic regions (habitat descriptions in Lindskog, 1975), and *C. tibetana* Drake, 1954, from Tibet. My re-examination of the species originally described as *Acanthia angulosa* Kiritshenko, 1912, and listed under *Teloleuca* by Reuter (1912) as well as Drake & Hoberlandt (1951) in their catalogue, has shown that it represents a true *Calacanthia* (a reference to this unpublished conclusion was made by Lindskog, 1975). The new species *C. grandis* from China shares with *C. tibetana* and *C. angulosa* the protruded anterolateral edges of the pronotum (fig. 16g). This character and the sharply notched ovipositor blades (fig. 17f) separate this Himalayan group of species from the arctic pair of species (compare with figs. 16f and 17e). *C. grandis* sp. n. may be on the average significantly larger than the other species; the single specimen at hand measures 7.5 mm. The largest size of the type series of *C. angulosa* is 6.0 mm (♀ submacropt.), whereas the type series of *C. tibetana*, including macropters, varies from 4.25–5 mm. *C. grandis* has proportionally much longer antennae; the ratio length antennal segments 2–4/width pronotal collar is 3.84 (2.3–2.9 in *C. angulosa*,  $n = 5$ ; 2.3–2.5 in *C. tibetana*,  $n = 3$ ). The second antennal segment is also more slender than in the other two species; its apex is about 0.7 the widest diameter of segment 1 (subequal in the other species). It remains, therefore, questionable whether the typical antennal character of *Calacanthia*, which is demonstrated so clearly in the male sex, applies also for *C. grandis*, males of which are not yet known. Other differences between *C. grandis* on the one hand, and *C. tibetana* and *C. angulosa* on the other are: dark pattern of extremities and forewings predominating in *C. grandis* and less in the other species (fig. 15d and fig. 15 e–i, respectively); erect dark setae scattered all over the head in the former, only two erect setae





Fig. 14. Pigment variation of wings of *Macrosaldula* species. a, *M. scotica*; b, *M. madonica*; c, *M. tadjhika*; d, *M. jakovleffi*; e, *M. nivalis*; f, *M. miyamotoi*. g, h, lateral and frontal side of male head; g, *M. nivalis*; h, *M. jakovleffi*.

on vertex in the latter two species. *C. tibetana* and *C. angulosa*, both from Tibet, reveal a close phenetic relationship, and I considered the possibility of conspecificity. However, some discrepancies may speak well for a specific status of both, awaiting more material from other localities. *C. tibetana* has a more sharply defined wing pattern (fig. 15i), indeed resembling *Teloleuca* species (e.g. fig. 15b) with the exception of *T. kusnezowi*. The spots on the wings of *C. angulosa* are less prominent and ash-black areas on corium and clavus prevail (fig. 15e—h). In the latter species, the basis of the exocorium is clearly wider than the adjacent part of the endocorium, whereas these parts in *C. tibetana* are at most subequal. The reduction of the forewing in not fully winged specimens is more marked in *C. angulosa* (weakly semibrachypterous, in terminology by Cobben, 1960) than in *C. tibetana* (submacropterous). A pronounced difference in reduction of flight ability can be deduced from the development of the hind wing. Its length is subequal to the fore wings in *C. tibetana*, but in *C. angulosa* the hindwings are only stubs, not surpassing the level of the scutellum apex. Such variations in wing development are apparently not related to differences in altitude. The type series of *C. angulosa* was collected at an elevation of 4300—4700 metres (I saw an additional ♀ from E Tibet, 4000 m, Shopando, Kham, 4.v.1936). The type material of *C. tibetana* originates from 5000 m altitude. Two other characters may be of value to separate both species, premised that additional material will confirm constancy. In *C. tibetana*, and not in *C. angulosa* and *C. grandis*, I found the ♀ ventral wing margin posteriorly of the hypocoastal lamina provided with weak transverse ridges (fig. 15c). The spermatheca of *C. angulosa* is more than three times as long as wide at its base (fig. 17b), whereas in *C. tibetana* it is spherical (fig. 17c). Although there is considerable intraspecific variation in the shape of the spermathecal bulb in *Saldula* species (Karnecká, 1974), the noted differences in *Calacanthia* being exactly the same in two specimens of each species checked, might prove to be of significance. The same counts possibly for the parameres (fig. 16b, *C. tibetana*; fig. 16c, *C. angulosa*) which could be studied in only one individual of each species.

#### *Teloleuca kusnezowi* Lindberg, 1934

Additional data. — The eunomic variation of the wing pattern of *T. kusnezowi* Lindberg, 1934, and other details of this species are pre-

sented in fig. 20, since after the original description based on one female from Khabarovsk no further records were published. Abundant new material reveals that the species is distributed in USSR as is shown on map 4, but also occurs in Japan. The localities in Japan and USSR, from which I have seen material, are as follows.

Japan (Hokkaido) Berabonai, near Ashoro, 2 ♂ 1 ♀, 8.vii.1958, leg. S. Miyamoto (together with *S. nobilis*); Aizankei, 5 ♂ 5 ♀, 1 larva, 9.viii.1967, leg. A. Nakanishi; Tennin-kyo, 1 ♂ 1 ♀, 1 larva, 27.vi.1967, leg. T. Saigusa; Yukomanbetsu near Mt. Daisetsu, 5 ♂ 5 ♀, 2.vii.1970, leg. H. Hasegawa. (Honsu) Mt. Yatudake, 4 ♂ 3 ♀, 18.vii.1939, leg. H. Hasegawa; Masutomi Kai, 3 ♂, 26—29.vii.1957, leg. S. Miyamoto. The Leningrad Museum contains series from the following localities: Amur region: Korsakovo, river Amur W of Svobodnyy, 3 ♂ 3 ♀, 24.vii.1959, leg. Kerzhner; Birsberta, river Zeya, 50 km of Blagovestshensk, 1 ♀, 19—26.vi.1914, leg. Popov. Khabarovskiy Kray: Imperatorskaya Gavan' (now Sovetskaya Gavan'), 1 ♀, 26.vii.1916, leg. Krylov, from Kiritshenko's collection; Ozerpakh, delta of river Amur, 1 ♀, 18.vii.1915, leg. Tshernavin. Primorskiy Kray: confluence of rivers Iman (now Bol'shaya Ussurka) and Tatyube (now Dal'nyaya), 1 ♀, 24.vii.1913 (Buyanova); Vinogradovka, 27 ♂ 10 ♀, 5—6.viii.1929, leg. Kiritshenko; river Suputinka (now Komarovka), 1 ♀, 26. vii.1935, leg. Samoylov; ibidem, 2.iv, 8.vii.1937 and 1 ♂, 22.vii.1937, leg. Richter; ibidem, 1 ♂ 3 ♀, 12—22.vii.1940, leg. Ivanov; ibidem, stony bed of the stream Egorskii Klyutsh, 1 ♀, 30.vii.1953, leg. Kurentsov; Vladivostok, 1 ♂, 27.ix.1932, leg. Rysakov; ibidem, Shamora (now Lazurnaya) bay, 12 ♀, leg. Stepanov & Shutova; river Sudzuke (now Kievka), 3 ♂, 12—15.viii.1948, leg. Sharov; river Peysula (now Suvorovka), 1 ♀, 12.vii.1963, leg. Nartshuk; Frolovka, Sutshan (now Partizansk) district, 1 ♂, 3.vii.1926 and 2 ♀, 7.vii.1926, leg. Rostovykh; Tigrovaya, same district, 3 ♂ 5 ♀, 26.vi—3.vii.1928, leg. Rostovykh; Fanza (now Rutsh'i), same district 1 ♂, 15.vii.1926, leg. Rostovykh; Derzhanovo, same district, 1 ♂ 1 ♀, 12.vii.1928, leg. Rostovykh; Sedanka, Vladivostok, 1 ♀, 20.vi.1927, leg. Sokolov.

#### *Salda kiritshenkoi* sp. n. (figs. 18a left, b, c, 21d)

Description. — For measurements, see table 1. Large (5.2—6.8 mm semibrachypterous, up to 7.8 mm macropterous), rather dull, coal-black species with fine cover of very short, densely packed brown setae. East-USSR, Japan, NE China.

Since the resemblance with *Salda muelleri* (Gmel.) is very strong, only the differences will be mentioned.

Male genital structures (fig. 15b, c) are of the



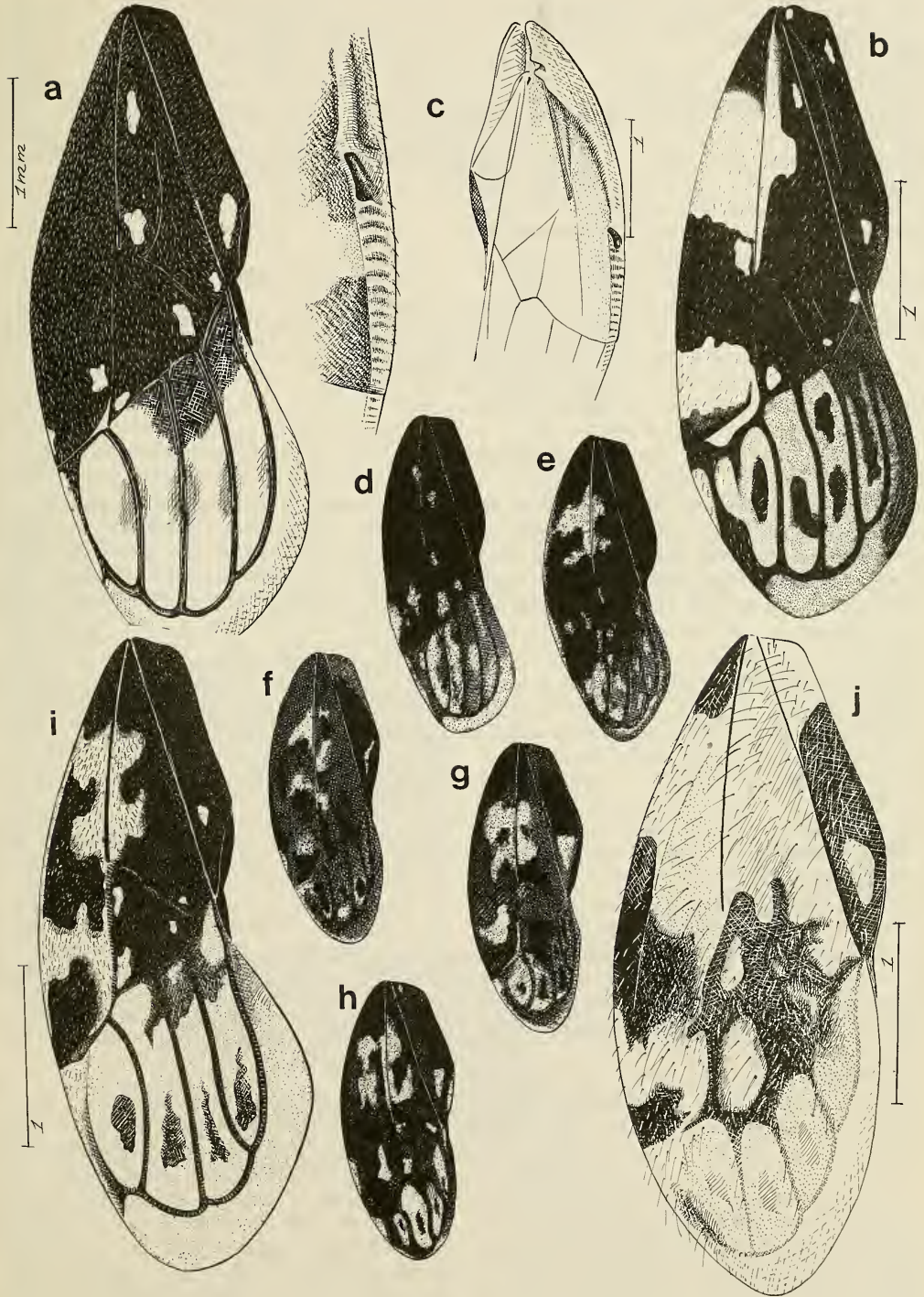

Fig. 15. Left forewing. a, *Macrosaldula nivalis*; b, *Teloleuca brancziki*; c—j, *Calacanthia* species; c, i, *Calacanthia tibetana*, c, underside of semibrachypterous specimen, with hyposcostal lamina and coupling pit (enlarged in left figure), i, macropterous specimen; d, *C. grandis*, holotype ♀; e—h, *C. angulosa* (cross-hatching on corium and clavus indicates ashy-black colour); j, *C. trybomi*.



	<i>kiritshenkoi</i>	<i>muelleri</i>
ratio length/width (semibrachypterous)	1.7—2.0	2.0—2.2
lateral wing margin	strongly convex (fig. 15a left)	less arched (fig. 15a right)
short brown hairs on upper side of thorax and wing	dense (fig. 18d), giving the species a more dull appearance	very sparse (fig 18b)
corium	without punctations	punctated
corial veins	hardly visible	distinct
colour	maxillary plates black, anteclypeus with narrow, light basis, only midpart of labrum lightish, first antennal segment and tibiae tending to blackish	mentioned parts in general more extensively ochreous lightish
head	with only few short hairs	somewhat more hirsute

same shape in both species. The most distinctive constant difference is the layer of short setae on the wing, which is much more dense and very regularly spaced and orientated in the new species (fig. 18d). I could not find any morphometric difference, except for the on the average broader shape of short-winged *S. kiritshenkoi*. All specimens lack any light spot on the corium, whereas in *S. muelleri* the mesocorium sometimes has one white spot. *S. morio* Zett., also a related species, has usually several endocorial spots, and is otherwise recognizable by the more or less shiny, not punctated cuticle. The only North American *Salda* species with which *S. kiritshenkoi* could be confused is *S. buenoi* (Mc Dunn). However, *S. buenoi* has part of the lateral wing margin almost straight, a more dense and longer golden pubescence, corium with light spots and longer distal processes of the median endosomal sclerite; such a prolonged sclerite is an apomorphic character of all other N. American *Salda* species, except for the Holarctic *S. littoralis* (L.).

Length of macropterous holotype ♂ 6.0 mm, width 2.8 mm. Length of paratypes varying from 5.2 mm (semibrachypt. ♂) to 7.8 mm (macropt. ♀).

Material. — Holotype (♂) (macropterous), USSR, Primorskiy Kray: valley of the river Odarka, about 25 km from Station Evgenévka (city Spassk-Dal'niy), 16.vi (old style calendar, = 29.vi), 1911, leg. A. Tsherskiy (in Zool. Mus., Leningrad). Paratypes, USSR, Primorskiy Kray, 1 ♀ semibrach., 2 ♀ macropt., idem 4. (= 17).vii.1911; Sivakovka, south shore of lake Khanka, 2 ♀ semibrach., 23.vi.1924, leg.

Samoylova; lake Khanka, Kamen'-Rybolov, 1 ♂, 30.vi.1910, leg. Tarobarov; Tshernigovka, 1 ♀ semibrach., 5.vii.(= 18.vii).1912, leg. Emelyanov; Ryazanovka, Khasan district, 3 ♂ 1 ♀ semibrach., 9.vii.1982, leg. I. Kerzhner; Vladivostok, Station Okeanskaya, 1 ♀ macropt., 10 (= 23).vii.1911, leg. Stshavinskaya, from the coll. of Kiritshenko. Khabarovskiy Kray: Krasnaja retshka, pr. Khabarovsk, 3 ♀ semibrach., 2 ♀ macropt., 2 ♂ semibrach., 10.vii.1931, leg. Pereleshina; Knyaze Volkonskoye, nr. Khabarovsk, 8 ♂ semibrach., 4 ♂ macr., 5 ♀ semibrach., 7.vii.1977, leg. Štys & Davidová (dry salt-steppe); Khabarovsk-Ussuri, 1 ♂ macropt., 1.vii.1978, leg. Štys & Vilimová; Khabarovsk south, 1 ♀, 4.vii.1977, leg. Šys & Davidová. Kunashir Island: Golovnin volcano, 2 ♀ semibrach., 10.vii.1980, leg. A. Gorokhov; Sernovodsk, Glukhoe lake, 1 ♂ 1 ♀ semibrach., 28.viii.1980, leg. Egorov & Kanyukova. NE China: railway stations Shanshi and Hailing between Harbin and Mudankiang, 1 ♀ semibrach., 7.vii.1902, leg. Krylov. Japan: Akkeshi, Hokkaido, 4 ♀ semibrach., 5. vii. 1958, leg. T. Nakane. Paratypes in Zool. Mus Leningrad, Jap. Nat. Museum and in coll. Wageningen, Hasegawa (Japan), Lattin (Oregon), Polhemus (Colorado), Popov (Moscow) and Štys (Czechoslovakia).

I have further seen a specimen (1 ♀ semibrach.) labelled: Proskurov (Khmel'nitskiy), vii.1895, leg. Zubovskiy; this locality is in the Ukraine, far away from the territories near the Sea of Japan. Future collections may prove whether the Ukraine indeed lies within the range of the species, or that the specimen in question has been mislabelled. A recent collection received from Dr Štys confirms that *S. kiritshenkoi* occurs much further to the West than expected. The new material is from Kirgi-

zia, Ala-Archa, 2000 m, near Frunze, 2 ♂ 2 ♀, 21.vi.1982, leg. Štys (very humid habitat along stream, on open places in between thick vegetation of moss and sedges). The only difference with the Far-East specimens is the fact that the central-Asian material has somewhat more pronounced elytral veins, lighter coloured hind tibiae and graphite-black membrane.

For comparative notes, see next chapter.

#### DISCUSSION OF EURASIAN SALDA SPECIES

The records of *S. kiritshenkoi* (map 3) suggest a broad-band distribution in Asia between 43° and 61° latitude. The labels do not always include data on altitudes, but the occurrence around the lake Khanka and the mentioned locality on Hokkaido suggest it to be a lowland species, although the Kirgizian population was found at 2000 m altitude. The closest relative, *S. muelleri*, also lives predominantly at low and submontanous altitudes. The distribution-map of this species so far shows only few scattered localities in the USSR (map 3), but it has a very vast, probably continuous distribution from West-Europe on to the Sea of Japan. I saw 1 ♀

from Khabarovsk collected together with a series of *S. kiritshenkoi* (leg. Štys & Davidová, 7.vii.1977).

Other species which could be confused with both *S. kiritshenkoi* and *S. muelleri* at superficial inspection are *S. morio* (Zett.), *S. micans* Jak. and *S. splendens* (Jak.). Since I could study the type material of the latter two poorly known species, further data on them are presented here.

The main differences of semibrachypterous specimens can be tabulated as follows.

When *S. kiritshenkoi* is added to the left of this table, we have a series of species with decreasing pubescence and increasing polished cuticle from left to right. *S. morio*, *micans* and *splendens* show a weak metallic lustre of the dorsal surface. *S. splendens* is easily recognised by erect semilong dark setae on thorax and hemielytra (fig. 16d). Identification of single individuals of *S. muelleri*, *morio* and *micans* may be difficult and the combination of tabulated characters may help the decision. There is a great overlap in body size and width but the mean value (underlined) of *S. muelleri* (20 ♂, length in mm 4.73—5.21—5.80, width 2.21—

	<i>muelleri</i>	<i>morio</i>	<i>micans</i>	<i>splendens</i>
hemielytra: texture	punctate, weakly shining	impunctate, more or less distinctly shiny, except for exocorium and membrane	polished, strongly shining	polished, strongly shining
hemielytra: setosity	with sparse, short setae (fig. 18b)	very scattered short setae (fig. 18a)	as <i>S. morio</i>	erect semilong dark setae in addition to sparse short setae (fig. 16d)
hemielytra: pigmentation	corium rarely with one midapical light spot; membrane of macropter for major part dark (fig. 16k)	corium often with some light spots; inner margin of membrane usually lightish, membrane of macropter for major part lightish (fig. 16j)	entirely black	entirely black
first coxa	black, apex sometimes lightish	black, apex often lightish	entirely pale	entirely pale
pigmentation of femora	fig. 16a	fig. 16b	fig. 16c	fig. 16c
pigmentation of first and second antennal segment	fig. 16e	fig. 16f	fig. 16g	fig. 16g

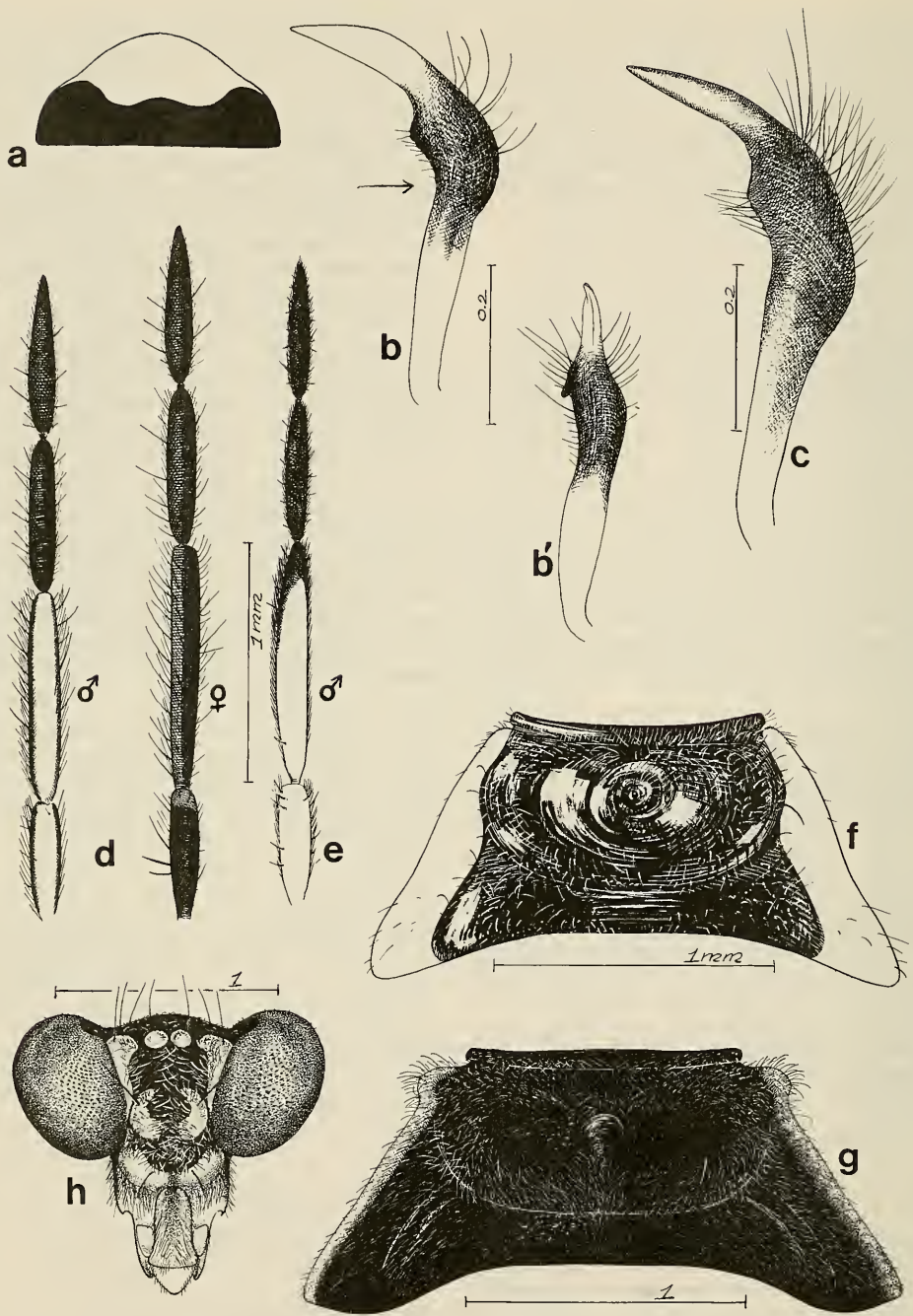

Fig. 16. *Calacanthia* species. a, f, h, *C. trybomi*; b, *C. tibetana*; c, e, g, *C. angulosa*; d, *C. alpicola*. a, subgenital plate ♀; b, c, left paramere, b, innerside, seen in direction of arrow in b; d, e, right antennae; f, g, pronotum; h, head, frontal aspect.



2.39—2.79; 17 ♀, length 5.30—5.98—6.55, width 2.73—2.98—3.20) is smaller than the respective dimensions of *S. morio* (18 ♂ 5.0—5.84—6.30, 2.53—2.63—2.80; 20 ♀, 6.08—6.54—6.96, 3.00—3.19—3.55). The material of *S. micans* and *S. splendens* is too limited to allow reliable comparison, but these species tend to fall into the size class of *S. muelleri* (*S. micans*, 3 ♂ length 4.5—4.9, width 1.8—2.1, 2 ♀ length 5.2—6.1, width 2.36—3.0. *S. splendens*, 3 ♂ length 4.4—4.8, width, 1.7—2.0, 2 ♀ length 5.7—6.5, width 2.6—3.1).

I could not find reliable differences, neither in the genitalia (the median penis sclerite seems to be more slender in *S. micans* and *splendens* (fig. 15j), but this should be checked in more specimens), nor in the many ratios calculated from a variety of measurements. Considerable variation of ratios exist, which is partly due to allometric differences between smaller and larger individuals.

The general facies of some smaller specimens of *S. splendens* and *S. micans* looks at first sight somewhat different from the other species (pronotum with straight lateral margins, humeral edges more acute and somewhat upturned). Other specimens are more like *S. muelleri* and *S. morio*, in which the shape of the pronotum also varies. The metallic lustre mentioned in the original description of *S. micans* is not consistently present in the series seen by me, but often also occurs in *S. muelleri* (according to Wróblewski, 1966) and in *S. morio*.

Whereas *S. muelleri* and *S. morio* from West Europe can be reliably discriminated, specimens from the eastern Palaearctic are more difficult to identify, especially the long-winged forms in which the dorsal cuticular texture tends to be intermediate. In macropters of *S. morio* from the USSR (Irkutsk, leg. Jakovlev, 3 ♂ 2 ♀, together with semibrachypterous specimens) the wing is less shiny, and of *S. muelleri* (4 ♀ from different localities in USSR) less punctate than in typical specimens. However, the difference in dorsal pubescence between both species remains constant; this is also mostly true for the difference in pigmentation of the membrane (fig. 16j, k). Since I had no opportunity to reidentify material of all published records from eastern regions, the distribution patterns of *S. morio* and *S. muelleri* remain somewhat uncertain (possible misidentifications). The identity of some specimens (see below) remains dubious until more material will be available for

study. The available information is summarized below under the individual species.

### *Salda muelleri* (Gmelin)

This species occurs further south in Great Britain (Scudder, 1958) and all over the continent than the next species (*S. morio*). In the mediterranean subregion it has been recorded incidentally from France (Puton, 1880). Greece (Reuter, 1895) and Turkey (Lindberg 1922). In Poland it is known from some 20 localities (Wróblewski, 1966) and in Czechoslovakia it seems to occur in northern localities of the Carpathian Basin (Benedek, 1970) and in Bohemia (Štys, unpublished). Both this and the next species have not yet been collected in Albania, Yugoslavia, Bulgaria and Roumania (Josifov, 1970). To the east, the exact distribution pattern is poorly known. Its occurrence is broadly indicated by Kiritschenko (1951) as: "Forest zone of the European part of the USSR up to Volyn', Khar'kov and Ryazan' provinces". Vinokurov (1979a) listed it for East Siberia, and Kerzhner (1978) as a questionable record for Kunashir Island which, however, appears to belong to *S. kiritschenkoi*. I have seen the following material, mostly from the Leningrad museum (semibrach. if not otherwise stated):

Leningrad region: Ol'gino, 3 ♂ 9 ♀, 6 larvae, 20.vi.1901, 17.vi—9.viii.1902, leg. Bianchi; Krupeli, 1 ♀, 30.vi.1897, leg. Mazarakiy; Terioki (now Zelenogorsk), 2 ♀, 1889, leg. Wagner; Shuvalovo, 1 ♂, 25.v.1897, leg. Zubovskiy; Chernaya Lakhta, 1 ♀, 1.vii.1904, leg. Bianchi; Log near Luga, 1 ♂, 1 larva, 18.vi—1.vii.1918, leg. Jacobson; Sablino, 1 ♂ 1 ♀, 21.vi.1921, 6.vii.1922, leg. Bianchi; Ostrovki, river Neva near Schüsselburg (now Petrokrepost'), 2 ♂ 1 ♀ macr., 5—6.vi. 1906 (leg. Jacobson); Lobanovo, 1 ♀, 14.vi.1906; Lakhta (now part of Leningrad), 1 ♀, 22.vi.1919, leg. Reichardt; Pomeranye, 2 ♂ 4 ♀, 10.vii.1911, leg. Ihgin; river Tigoda, 4 ♂ 1 ♀, 4.vi.1911, leg. Semenov - Tjan - Shanskij (series of this locality somewhat less punctate); Svir, 1 ♀, (?), leg. Günther; Lisij Nos (now part of Leningrad), 1 ♀ macr., 20.vi.1889, leg. Silantyev.; Zelenogradskaya railway Station, near Moscow, 1 ♀, (?), leg. Y. Zhezekhin (in coll. Popov). Karelian SSR: Petrosavodsk, 1 ♂ 1 ♀, (?), leg. Günther; Muromli, 1 ♂ 1 ♀ (?), leg. Günther; Vitebsk region: Vitebsk, 1 ♀, (?), leg. Birula. Arkhangelsk region: Shipitsino, 3 ♂ 3 ♀, 1 ♀ macr., 1 larva, 20.vi and 6.vii.1942, leg. Stark (note of Dr Kerzhner: "at my experience this label is wrong and refers to insects collected in more southern regions"). Pskov region: Kharlamova gora near Gdov, 1 ♂ 1 ♀, 15.vi.1898 (leg. Bichner). Kalinin region: Bologoe, 2 ♀, 1 larva, 5.vii.1903, 10.vi.1904, 11.viii.1904. Estonian SSR: Gapsal (now Haapsalu), 1

♀, (?), leg. Morawitz; Sillamyagi (now Sillamyae), 1 ♀, 25.vi.1930, leg. Bianchi; Merrikul, 1 ♂, 7—10.vii.1904, leg. Somira. Volgograd region: Sarepta (now part of Volgograd), 2 ♂, (?), leg. Becker, Ryazan region: Kazachiy near Rannenburg, 1 ♀, 24.vi.1903, leg. Semenov. Ukraine: Rovno region: Krasnoe, near Dubno, 1 ♂ 1 ♀, (?), leg. Karavaev; Chernyakovo near Ostrog, 1 ♀, 1—5.vii.1900, leg. Neklyudov. Volyn' region: Zamostochoye near Senki, 1 ♀, 14.vi.1905, leg. Birula. Khmel'niitskiy region: Kamenets-Podolskiy, 1 ♀, (?), leg. Birula. Donetsk region: Yarovaya near Svyatogorsk (now Sosnovo), 1 ♂, 19.vi.1938, leg. Arnoldi. Kazakhstan: Aktyubinsk region: Berchogur, Mugodzhazy Mts., 1 ♀, 8.vii.1932, leg. Lukjanovitsh. Turgay region: Kokshe-tau Mts, 1 ♀, 23.vi.1957, leg. Asanova. Siberia: Irkutsk region: river Belaya, tributary of Angara, 2 ♂ 1 ♀, leg. Gartung. Maritime Province Far East, Primorskiy Province, Knyaze Volkonskoye near Khabarovsk, 1 ♀ macr. (together with *S. kiritshenkoï*), 7.vii.1977, leg. Štys & Davidová.

#### *Salda morio* (Zetterstedt, 1840)

As far as it can be concluded from the available reliable records this species has a more distinct northern Eurosibirian distribution than the foregoing species. Its range extends eastward into N. Mongolia (Josifov & Kerzhner, 1967, Hoberlandt, 1971a, Vinokurov, 1979b), Kuril Isl. (Kerzhner, 1978) and Japan. I have verified Russian material from the following localities:

Karelia, Muromli, 2 ♀, leg. Günther; idem, Ladoga, 1 ♀, leg. J. Sahlberg; Ukraine, Krasnoe, Volyn' region (now in Rovno province), 1 ♀, leg. V. Karavaev (together with *S. muelleri*); environment of Irkutsk, Pashkovskoe, river Angara, 1 ♂, and Markovo, 2 ♂ 1 ♀, leg. Jakovlev; Mongolia East aimak, river Nömrögin-Gol, 32 km SE of Mt. Salkhit, 1 ♂ 1 ♀, 8.viii.1976, leg. I. Kerzhner; East aimak, Mt. Derkin-Tsagan-Obo, 60 km ENE of Bayan-Burd, 1 ♂ 1 ♀, 3.viii.1976, leg. I. Kerzhner; Transbaicalia, river Ingoda, 1 ♀, 11.vii.1989, leg. G. L. Suvorov (type locality of *S. splendens*); Amur region, Samodon near Korsakovo, 1 ♀, 7.viii.1959, leg. I. Kerzhner; Klimoutsy 40 km W of Svobodny, 1 ♂ 1 ♀, 15.vii.1959, leg. I. Kerzhner; Primorskiy Kray, Ryazanovka, Khasan district, 3 ♂ 1 ♀, 9.vii.1982, leg. I. Kerzhner; Saghalien, Shiritori (now Makarov), 1 ♂ 2 ♀, 3.viii.1938, leg. H. Hasegawa.

The only published record of *S. morio* in Japan is the Oze district, Honshu (Asahina & Hasegawa, 1951, and Hasegawa, 1954). I have seen long series from this region and can conclude only provisionally that this belongs to *S. morio*, despite of some minor differences with European specimens (corium between veins less shining). I further studied 2 ♂ and 1 ♀ from

Hokkaido, Mt. Daisetsu, 8.viii.1967, leg. A. Nakanishi.

Dr Lindskog (Stockholm) kindly sent me for judgment 1 ♂ and 1 ♀ collected by Poppius near Ytyk-haja, Lena River (in Zool. Mus., Helsinki), identified as *S. morio* by H. Lindberg. As Lindskog already noticed both specimens have a very polished dorsal surface, the outer margin of the exocorium being dull. The highly shining wings, without erect setae, are reminiscent of *S. micans*, but in contrast to this species, the corium bears lightish spots and the membrane is largely unpigmented. Both rather large specimens (♂ 5.9 mm, ♀ 6.5 mm) are somewhat teneral. Provisionally, I must conclude that they belong to *S. morio*, awaiting larger samples from that region.

#### *Salda micans* Jakovlev, 1889

Five specimens are located in the Leningrad Museum, one of which (♀) from the type locality: Kultuk (leg. B. Jakovlev). I designated this specimen as the lectotype with an appropriate red label. The data of the other specimens seen by me are as following:

Tuva (Tuvian autonomous province): Shagonar forestry, river Ulug-khem (= Yenisey), locality Adar-khysh, 2 ♂ 1 ♀, 2.vii.1956 (leg. Levin); Yakutian (Yakutian ASSR), Badarannakh, ca. 100 km W of Yakutsk, 1 ♂, 17.viii.1926, leg. Ivanov. These localities are plotted on map 3.

#### *Salda splendens* (Jakovlev, 1905)

Five specimens from the type locality are located in the Leningrad Museum (Transbaikalia, river Ingoda, 2 ♂ 3 ♀, 11.vii.1898, leg. G. L. Suvorov; 1 ♀ has no locality label, but the same collector label). I designated one of the males as the lectotype with an appropriate red label. The following new additions can be mentioned:

Tunskinskies Gol'tsy Mts, E. Sayan mountain region in Buryatian ASSR, E. Siberia, 1 ♀, no other data; erect hairs somewhat rubbed off (in Coll Mus. Nat. Hung.). Badarannakh, ca. 100 km W of Yakutsk, 16.viii.1926, leg. Ivanov (pin with only rostrum and one forewing); this locality is the same as one given for *S. micans*, but collected one day earlier; N. Korea, Daitaku, Kankyo-hokudô, 2 ♂, 8.viii.1939, leg. M. Tanaka (1 ♂ in Ent. Lab. Kyushu Univ. Japan, 1 ♂ in coll. Wageningen). Localities are plotted on map 3.

#### *Salda littoralis* (Linnaeus, 1758)

Also on the status of subspecies *piechockii* Wagner, 1967, and of *S. nevadensis* Wagner, 1960.

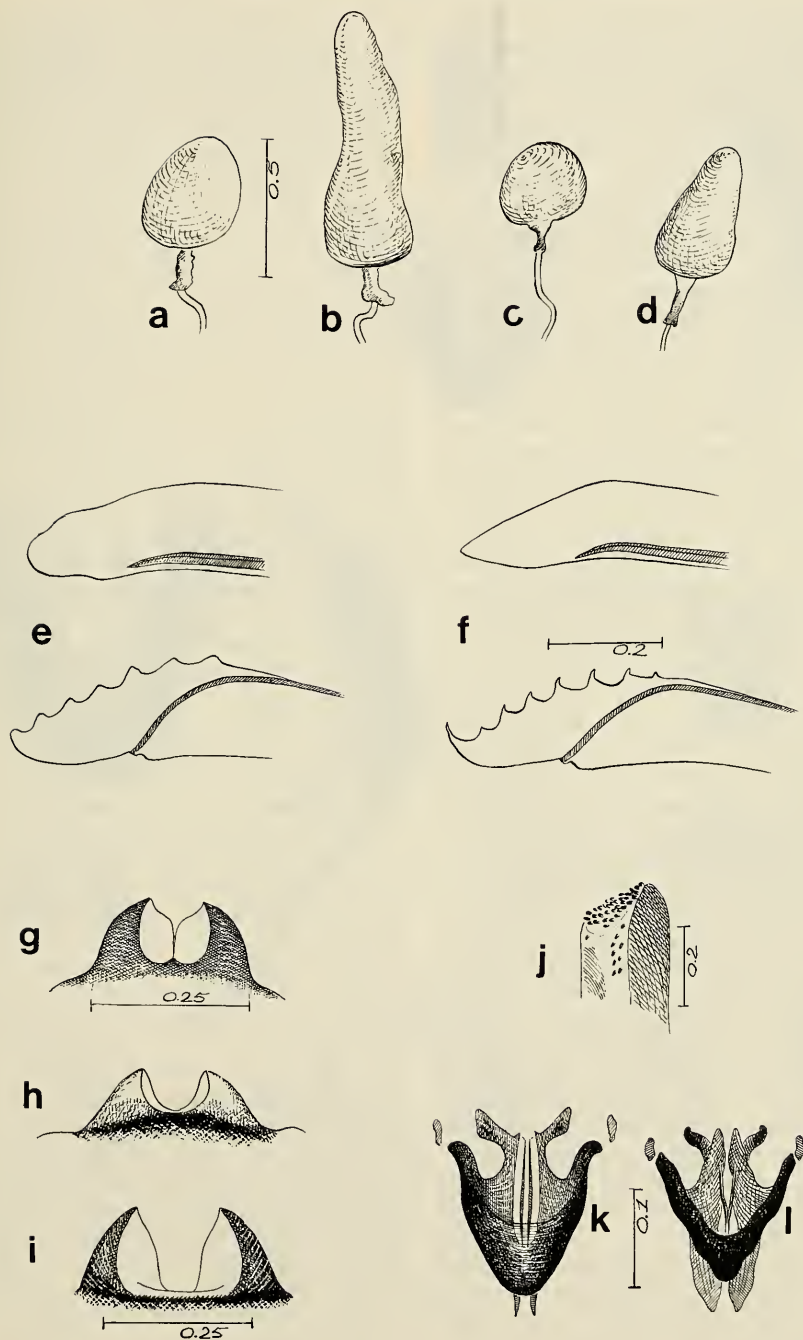

Fig. 17. *Calacanthia* species. a, e, i, *C. trybomi*; b, f, g, *C. angulosa*; c, f, g, j, k, *C. tibetana*; d, f, *C. grandis*; h, l, *C. alpicola*. a—d, spermatheca; e, f, right view of ovipositor gonapophyses; g—i, parandria; j, right grasping plate of ♂; k, l, median endosomal sclerite.



*S. littoralis* is the most wide-spread representative of the genus in the whole of Europe and Palaearctic Asia. The material which I have seen from Japan (first recorded for this country in 1968, Hiura), Alaska, Canada, N USA (16 specimens from eight localities), indeed conforms entirely in external and internal structures with specimens from Europe. From the abundant material present in the Leningrad Museum and Popov's collection (Moscow), partly plotted on map 3, we may conclude that the species occurs everywhere in the USSR where suitable habitats occur (marine and inland salt-marshes, exposed fresh-water swamps in mountainous areas). The next to no data from W. Siberia may be due to paucity of collections made in that region (Kerzhner, correspondence). The remarkable ecological duality of *S. littoralis* is most prominent in W. Europe where the species is restricted to salines along the Atlantic coast and to mountains from 1800 up to 2300 metres altitude (the Alps, Heiss, 1972; the Pyrenees, pers. observ.). It is remarkable that *S. littoralis* seems to be absent in the Carpathian mountains (Benedek, 1970, Hoberlandt, 1977, Štys, pers. comm.). On the other hand, this mountain chain everywhere harbours the endemic saldid *Teloleuca brancziki*, which lives on flat finely graveled banks of larger streams. *S. littoralis* does not inhabit such localities, so that its absence in the Carpathians can not be simply explained through displacement by *T. brancziki*.

The most southern inland-population in W. Europe, the Sierra Nevada, Spain, was described as a valid species: *Salda nevadensis* Wagner, 1960. However, I could not confirm the stated differences between this species and *S. littoralis*. The latter species should have larger eyes, the vertex being only 0.85—0.90 (♂) and 0.95—1.02 (♀) times as wide as one eye. The head and especially the gula should be longer, the labrum larger and more porrect, the pronotum and forewings wider than in *S. nevadensis*. My measurements, based on eight male and 14 female paratypes of *S. nevadensis* and on a double number of *S. littoralis* from various origins in the NW and NE Palaearctic, do not show divergence in the characters mentioned. For example: the ratio head width/width of vertex varies in *S. littoralis* between 2.41—2.54 (♂), 2.22—2.39 (♀), and in *S. nevadensis* between 2.46—2.50 (♂), 2.33—2.39 (♀). The ratio body length/width of *S. nevadensis*: 2.13—2.24 (♂), 1.97—2.15 (♀), also falls within the range of variation in *S. littoralis*: 2.07—2.23 (♂), 1.94—

2.15 (♀). The only remaining actual difference between *S. littoralis* and the single population of *S. nevadensis* is the overall smaller body-size of the latter; reduction in body dimensions is not surprising since the type locality of *S. nevadensis* is at nearly 2900 m altitude. However, this discrepancy is not so pronounced as stated by Wagner. For his new species he mentioned a length of 4.7—5.1 mm for the males and 4.9—5.4 mm for the females. He contrasted these numbers with 6.0—6.5 (♂) and 7.0—7.5 (♀) in *S. littoralis*. However, according to the literature (Cobben, 1960), the length of *S. littoralis* varies between 5.1 and 6.0 mm (♂) and 5.9—7 mm (♀) in the semibrachypterous form. The lengths of males of 6.0 up to 6.5 mentioned by me in 1960 applied to macropters, but since the nearly sixty original individuals of *S. nevadensis* are all semibrachypterous, comparisons should be made with that morph only. Finally, Wagner (1960) stressed the fact that, whereas male and female of *S. littoralis* fall in clearly different size classes, the sexes of *S. nevadensis* can only be separated by checking the genitalia. Judging from the sample I have seen, this seems somewhat overstated. The 14 females at hand vary from 5.4—5.7 mm, and the males from 4.8—5.0 mm. After all these refutations I must conclude to the synonymy of *S. nevadensis* with *S. littoralis* (**syn. nov.**). It is submitted that this is done purely on morphological grounds, but we may not expect that proof or disproof of reproductive isolation between the Sierra Nevada population and other populations will be supplied in the near future.

The description of *S. littoralis piechockii* Wagner, 1967, from Mongolia (1160—1750 m) suffers likewise from discrepancies with the real situation. This subspecies of about equal size as the nominate form, should have a more slender body shape, and shorter antennae and legs. The type material, which I could study (5 ♂, 3 ♀), conforms in these respects with typical *S. littoralis*. The subspecies *piechockii* should have four windings of the base of the penisfilum, and the nominate subspecies 5. I checked the 5 males on this character, but I found the basal length of the filum fit within the variability range of *S. littoralis*. In my view there is no valid criterium to uphold the subspecies taxon *piechockii*.

The coastal subpopulation of *S. littoralis* seems to have undergone at least one speciation process somewhere along the Adriatic Sea. Deviating material was originally described as a variety of *S. littoralis*, viz. *adriatica* (type locality

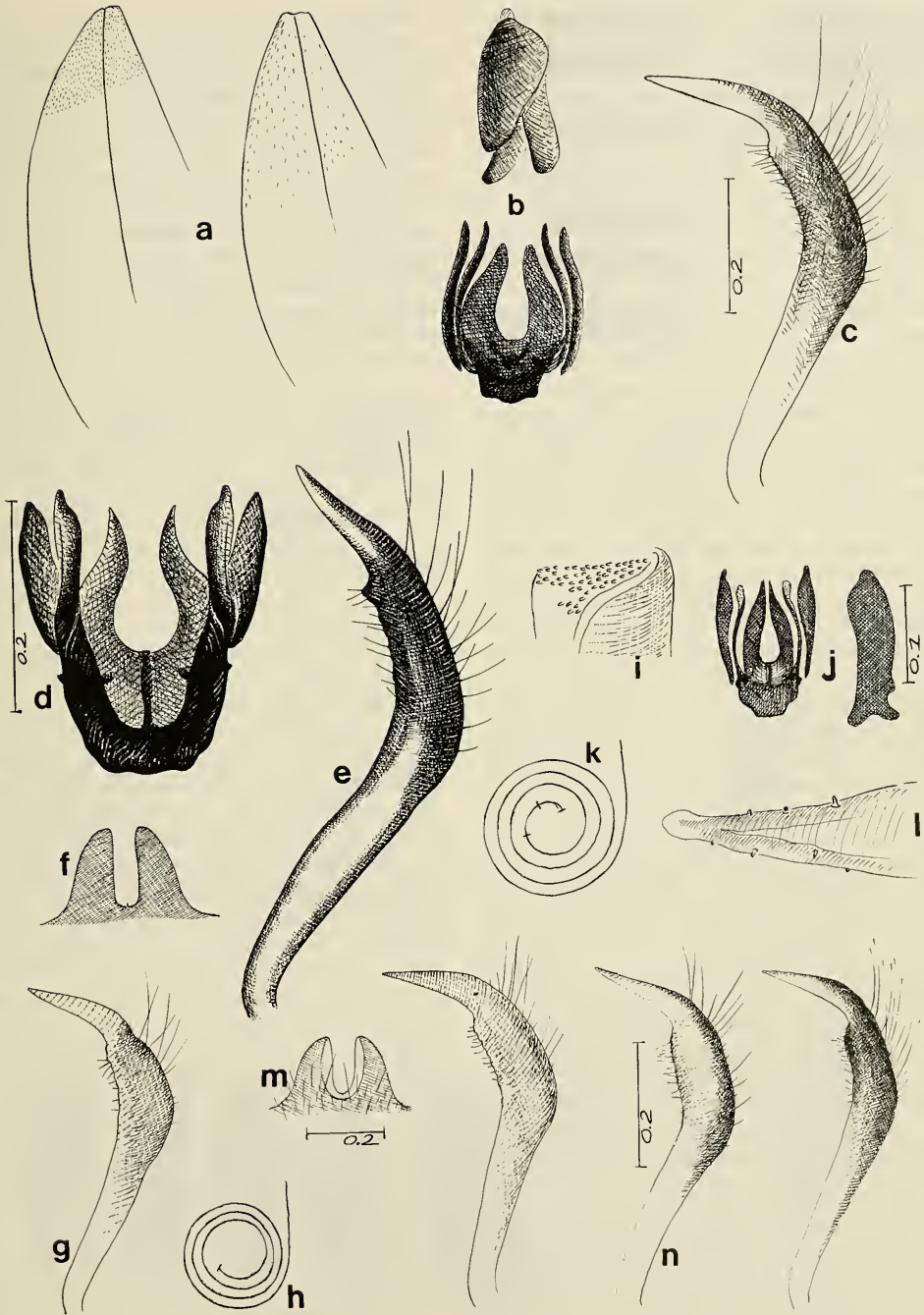

Fig. 18. *Salda* species. a, anterior part of corium of left fore wing, outline of lateral margin and vestiture of small setae; left, *S. kiritsjenkoi*; right, *S. muelleri*; b, c, *S. kiritsjenkoi*; b, median endosomal sclerite; below plane view; above, left lateral view; c, paramere; d, e, *S. morio*; d, median endosomal sclerite; e, paramere; f—h, *S. micans*; f, parandria; g, paramere; h, penisfilum; i—n, *S. splendens*; i, male grasping plate; j, median endosomal sclerite; left, plane view; right, left lateral view; k, base of penis filum, length of three individuals; l, apex of paramere; m, parandria; n, parameres; left, specimen from N. Corea; middle and right from type locality.



"Illyria") by Horváth, 1887, and subsequently (1901) recognized by himself as a valid species. Specimens studied by me at the time from the Gulf of Venezia indeed are characteristic enough to warrant specific status (Filippi, 1957; Cobben, 1960). *S. adriatica* has subsequently been reported from Greece and Bulgaria (Josifov, 1961, 1970). The population structure of this group of shore bugs in the Balkans and Asia Minor became, however, more complex after the description of *S. subcoriacea* Horváth, 1901 (type locality, Turkey, Aydin, close to the Marmara Sea). To judge from the description, this *Salda* is more or less intermediate between typical *littoralis* and *adriatica*, and therefore I treated it, in 1960, provisionally as a subspecies of *S. littoralis*. As such were also identified specimens from Turkey (Hoberlandt, 1948) and Greece (Josifov, 1970). A deliberate decision on its taxonomic status and its relation to the *S. littoralis-adriatica* complex must be postponed until long series are sampled at regular intervals along the coastal lines of the Adriatic, Aegean, Black and Caspian Seas. The seasonality should also be considered. *Subcoriacea*-like adults were collected by me in a coastal swamp in Greece (near Khalkis, 29.vii.1978). I brought them living to Wageningen, hoping that these animals from 30.5° latitude would be easier to rear than *S. littoralis* from higher latitudes and altitudes. This species is univoltine in W and N Europe and has an obligatory winter-diapause in the egg stage lasting nine months (Jordan & Wendt, 1938; Cobben, 1968). This makes it very difficult to rear large numbers in succession. My purpose was to try to hybridize the Greek population with *S. littoralis* from the Netherlands and the Pyrenees. However, it appeared that also the animals from Greece went directly into a strong egg diapause under normal laboratory conditions. Such a phenology is reminiscent of a northern origin of the ancestor of *S. littoralis*. It would be interesting to know whether the true *S. adriatica* of the Venezia lagune still has retained this rigid life cycle.

#### TENTATIVE KEY TO *MACROSALDULA* SPECIES

Some historical remarks on the ranking of the taxon *Macrosaldula* as a genus were given on page 232. Most species of this group are externally recognizable by heteropterists familiar with shore bugs by their rather stout size, slender and mostly dark coloured habitus with proportionally long antennae without long erect setae on the second segment, and by their lapidi-

colous and agile behaviour, preferably along streams. The combination of these characters separate them from the smaller sized species of typical *Saldula*, a cosmopolitan genus most rich in species, and from some less typical *Saldula* subgroups, among which the *orthochila* group (page 226). The limits of both supraspecific taxa *Macrosaldula* and *Saldula* will be phylogenetically redefined elsewhere; in such a study other less obvious characters will also play a role. Some *Macrosaldula* species strikingly deviate in colour (*inornata*, *heyningeni*), or in colour and swollen antennae (*roborowskii*, see below) from the other group members. Three species deviate in some less readily visible, but important characters, such as: shape of hypocoastal wing margin, position of stigmata, and shape of median endosomal sclerite. These species are *koreana*, *monae* and *rivularia*, of which the generic position may need adjustment later. It is only for practical reasons that I include all 21 species listed in the following key as belonging to *Macrosaldula*. The key includes also one species which up till now has not been associated with *Macrosaldula*-like species, viz., the species described by Jakovlev (1890) as *Salda roborowskii* from the western part of China ("Chinesian Turkestan"). It was placed in *Chartoscirta* by Reuter (1895), Oshanin (1912), Hoffmann (1933), Wu (1935) and Drake & Hoberlandt (1951), spelled as *roborowski*). Dr Kerzhner informed me that the type series from "Oasises Nia and Keria" included more than one specimen judging from the indicated length (4¼—4½ mm). At the present time the type specimens could not be traced in the Leningrad Museum, but I could study another series located in that museum, apparently belonging to the same species. This material (1 ♂ 2 ♀) was collected along the river Tisnaf, 6.viii.1890, leg. Grombschewski. The locality is about 500 km W of the type locality and is plotted on the distribution map 1. Both localities are, according to Kerzhner, along the old route passing between the southern part of the Takla-Makan desert and adjacent mountains; the altitude is about 1500—2000 m. Examination of this material reveals that it represents a member of the *Macrosaldula* clade according to the elongation of antennae and structure of the male grasping plate and genitalia. It lacks the two synapomorphies of *Chartoscirta* species (hind femur with stridulatory ridges, spherical median endosomal sclerite), but the swollen antennae (fig. 13e), somewhat elevated callus of the pro-



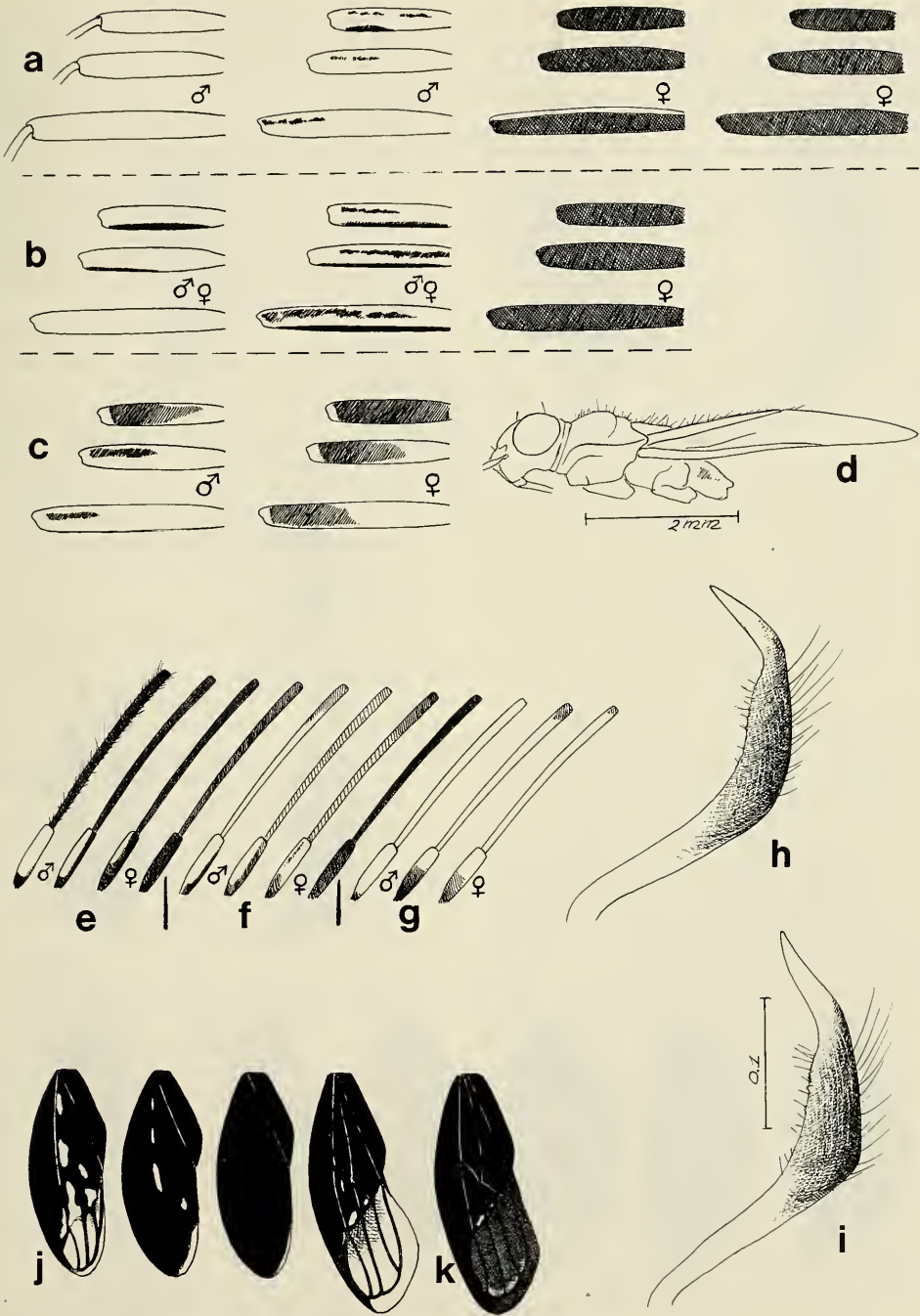

Fig. 19. *Salda* species. a—c, left side of left femora 1—3; a, *S. muelleri*; b, *S. morio*; c, *S. micans* and *S. splendens*; d, *S. splendens*, left view of holotype; e—f, antennae; e, *S. muelleri*; f, *S. morio*; g, *S. micans* and *S. splendens*; h, i, paramere of *S. micans*; j, *S. morio*, Saghalien, Japan, pigment variation of wing; k, *S. muelleri*, macropterous wing.

notum (fig. 13g), and the contrasting brown-white pattern of the corium (fig. 13c) are to some extent reminiscent of *Chartoscirta*, especially *C. dilutipennis* (Reuter), occurring in Turkestan.

I present in this paper also the illustrations of individual parameres of a number of *Macrosaldula* species. The differences exhibited should not be regarded as absolute, since the intraspecific variability has to be tested on population level. In general, paramere morphology is of only limited diagnostic value in saldids. The eunomic series of wing pattern shown in some illustrations must also be considered with some caution. I selected only those variations which reveal a smooth gradation from light to dark colour forms. Certainly, numerous small deviations from the ideal eunomy will be encountered. For some species additional material may prove that the extremes of the light and the dark morphs will exceed the illustrations provided here. Distributions are given on a large scale. For detailed country records and data on ecology see Cobben (1960), Heiss (1972), Hoberlandt (1977), Lindskog (1975), Vinikurov (1979b), and Wróblewski (1966).

1. Antennal segment 2 1½ times and segment 4 about 2 times as thick as segment 2 in the middle (fig. 13e). Colouration of wing castaneous brown with two transverse white fascia (fig. 13c). Pronotum with pale margin; callus somewhat swollen; (W China) . . . . . *roborowskii* (Jakovlev, 1890) comb. nov.
  - Distal segments of antennae not dilated. Colouration of wings otherwise . . . . . 2
2. Wings inclusive of clavus, and legs largely straw-yellowish. Lateral pronotal sides broadly pale (fig. 8); (Iraq) . . . *inornata* sp.n.
  - Dark pigment prevailing . . . . . 3
3. Corium and clavus entirely devoid of lightish spots. Wings with only adpressed short setae . . . . . 4
  - Corium and often clavus provided with lightish pattern. Wings with only adpressed short setae, or with erect semilong or long setae in addition to short pubescence . . . . 8
4. Dorsum shining. Inconspicuous pubescence regular, very short and adpressed. Vertex and pronotum without erect semilong setae . . . . . 5
  - Dorsum dull. Adpressed short pubescence more dense and conspicuous. Vertex and pronotum with some erect dark setae almost as long as the six cephalic bristles . . 6
5. Strongly shining with blue-violet reflection (for further differences with the next species, see p. 240); (Far East of the USSR, Japan) . . . . . *violacea* sp.n.
  - Less obviously polished, deep-black, sometimes with faint bluish reflection; (Far East of the USSR, Korea) . . . . . *koreana* (Kiritschenko, 1912)
6. Middle pair of cephalic trichobothrial setae arising from pale spot (for further difference with next species, see p. 238) (Siberia, Mongolia, Alaska) . . . . . *rivularia* (Sahlberg, 1878)
  - Middle pair of cephalic trichobothrial setae arising from black cuticle . . . . . 7
7. Ratio antennal segments 2 + 3 + 4/width of pronotal collar above 3.6. (USSR, region Krasnoyarsk-Irkutsk) . . . . . *simulans* sp.n.
  - Ratio antennal segments 2 + 3 + 4/width of pronotal collar below 3.6: dark extreme of *variabilis variabilis*, and possibly other species of which the extreme melanistic form is not yet known . . . . . 8
8. Corium with large subapical orange mark on exocorium; otherwise unicolorous black; (Italy, Spain) . . . . . *hejningeni* (Cobben, 1959)
  - Corium with varying lightish pattern . . . 9
9. Pronotum with pale lateral margins. Middle pair of trichobothrial-like cephalic setae arising from pale spot (fig. 7d) . . . . . 10
  - Pronotum and frons of head entirely black . . . . . 11
10. Clavus proximally with longitudinal lightish spot (fig. 7a); dorsal pubescence not dense, golden; (Transcaucasia) . . . . . *clavalis* sp.n.
  - Clavus proximally without lightish spot; dorsal pubescence dense, silvery; (Mongolia) . . . . . *kaszabi* (Hoberlandt, 1971)
11. Exocorium with narrow ochreous costal margin along entire length (fig. 10i, n); (S. Kazakhstan) . . . . . *kerzhneri* sp.n.
  - Corium with varying light-dark pattern 12
12. Longest semi-erect dark setae of corium longer than diameter of tibia 3 . . . . . 13
  - Longest semi-erect dark setae of corium subequal to or shorter than diameter of tibia 3 . . . . . 18
13. Pronotum without erect setae extending beyond lateral margin. Exocorium with only adpressed short, lightish setae, and a submarginal longitudinal strip devoid of any setosity; base of exocorium mostly wider than base of endocorium, part of lateral

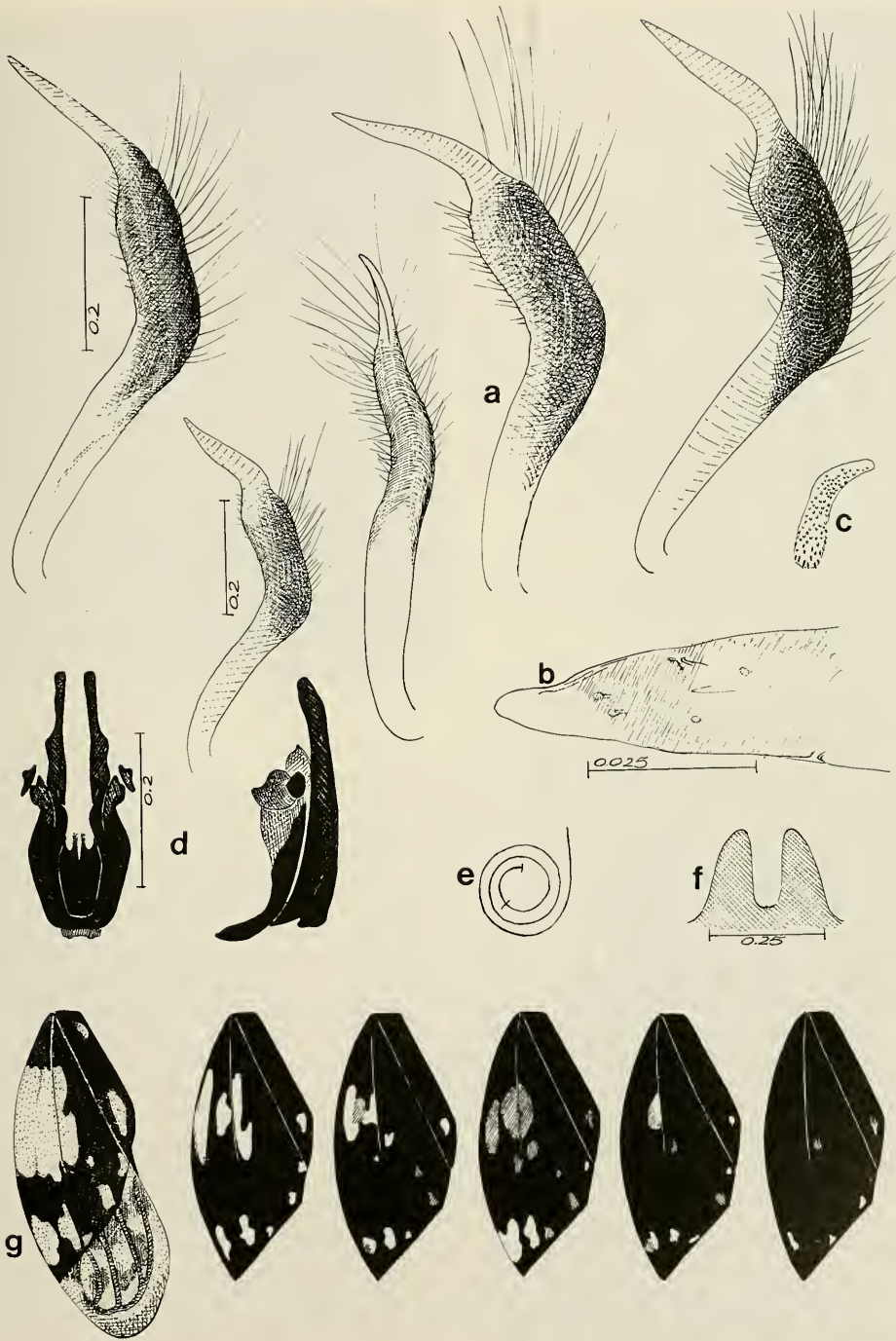

Fig. 20. *Teloleuca kuznezovi*. a, parameres, specimens from different localities in E. Russia and Japan (second picture from left); b, apex of paramere; c, male grasping plate; d, median endosomal sclerite; left, plane view; right, left lateral view; e, base of penisfilum; f, parandria; g, variation of dark-light pigment pattern of fore wing.



outline of forewing straight (fig. 12c). White-black pattern of corium contrasting (fig. 13h); clavus sometimes with subbasal spot. *variabilis connectens* (Horváth, 1888)

The explanate base of the exocorium of *M. variabilis* is not always clear, and sometimes also occurs in other species, e.g. *M. jakovleffi* and *M. nivalis*; these two species, however, lack the hairless exocorial submarginal strip. It is still uncertain whether *connectens* must be considered a subspecies of *variabilis* or a proper species. I have seen material from Morocco, Yugoslavia, Albania, Bulgaria, Rumania and Greece, corresponding with *connectens*. True *variabilis* (endocorium without erect setae) was seen from Sweden, Belgium, France, Spain, Germany, Poland, Austria, Switzerland, Italy, Hungary, Greece, Iran, Iraq and USSR (Georgia, Armenia). This picture would favour the idea of two separate species, with sympatry in the Balkan countries. However, material seen by me from Turkey and Palestine is more or less intermediate as regards the setosity of the endocorium.

- Pronotum with erect setae distinctly extending beyond lateral margin; entire corium with erect setae in addition to adpressed pubescence ..... 14
- 14. Erect setae of second tibia longer than the spines; erect setae along entire length of third tibia longer than the spines (see also note under *M. scotica*, couplet 16 of this key); (Japan, Shikoku) .. *shikokuana* sp.n.
- Setae of second tibia not longer than the spines ..... 15
- 15. Erect setae on external proximal part of third tibia longer than the spines ..... 16
- Erect setae on external proximal part of third tibia subequal to or shorter than the spines ..... 17
- 16. Lightish pattern of wing predominantly restricted to exocorium (fig. 14b); large subapical spot on exocorium also persistent in dark specimens; lightish subapical spot of clavus only rarely present. Dorsal pilosity dense; length of erect setae about two times the diameter of the hind tibia; silvery decumbent setae dense, semilong, somewhat shaggy; (Sicily)..... *madonica* (Seidenstücker, 1961)
- Lightish spots distributed on exo- and endocorium; subapical spot on clavus only absent in dark variants (fig. 14a). Dorsal erect and adpressed pilosity less dense; erect setae subequal to or slightly longer than diameter of hind tibia; (Europe, European part of the USSR; earlier records from Japan refer to *S. nobilis*) ..... *scotica* (Curtis, 1835)

I have seen one male from Turkey (Caycuma, 31.v.1980, leg. Hava) and two females from Caucasus (Krasnaya, no date, leg. Zhelokhovtsev; Azan, 2600 m, above Rhododendron zone, 1.vii.1974, leg. Behác), with longer pilosity on the legs, nearly as in *M. shikokuana* (couplet 14). In the latter species the dark parts of the wings are ashy-semipruinose black with the distal part of endocorium and medial half of clavus deep satin black. The dark wing pigment of *M. scotica* is unicolorous black. Additional material is needed for a taxonomic interpretation of this type of geographic variation of *M. scotica*.

- 17. Clavus proximally always with small yellowish spot near edge bordering the corium and sometimes with an elongate spot in the edge bordering the scutellum (14f). Light-dark pattern of corium contrasting; lightish spots yellowish; spot on mid part of exocorium divided longitudinally (fig. 14f). Dark pigment of margin of exocorium and apical area of endocorium intense black, contrasting with otherwise ashy black colour; (Japan) ..... *miyamotoi* sp.n.
- Proximal part of clavus entirely black. Contrast between light and dark pattern of corium not sharply defined. Light spots greyish white; spot on mid part of exocorium usually large and undivided (fig. 14c). Dark pigmentation uniform ashy-black; (Uzbekistan) ..... *tadzshika* (Kiritschenko, 1912)
- 18. First acetabula entirely or partly lightish 19
- First acetabula black ..... 21
- 19. Wings dull, with only adpressed short silvery setae. Middle trichobothrial-like cephalic setae arising nearly always from pale spot. First coxae for major part pale. Wing pattern variable; preponderance of white markings on endocorium; in darker forms markings disappear first on exocorium; (Alaska)..... *monae* (Drake, 1952)
- Wings weakly shining; semilong erect setae are present in addition to the short decumbent golden pubescence ..... 20
- 20. First acetabula entirely pale. Wing pattern as in fig. 14l; (E. Kazakhstan)..... *oblonga acetabularis* subsp.n.
- First acetabula dark with pale apical margin. Corium for major part testaceous (fig. 14k); membrane hyaline. Clavus sometimes with subbasal pale stripe. Legs predominantly yellowish; (Kazakhstan) ..... *koktshetavica* sp.n.
- 21. Second antennal segment with only very short pubescence. Proximal part of exocorium wider than base of endocorium (fig. 12b); part of external outline of left and

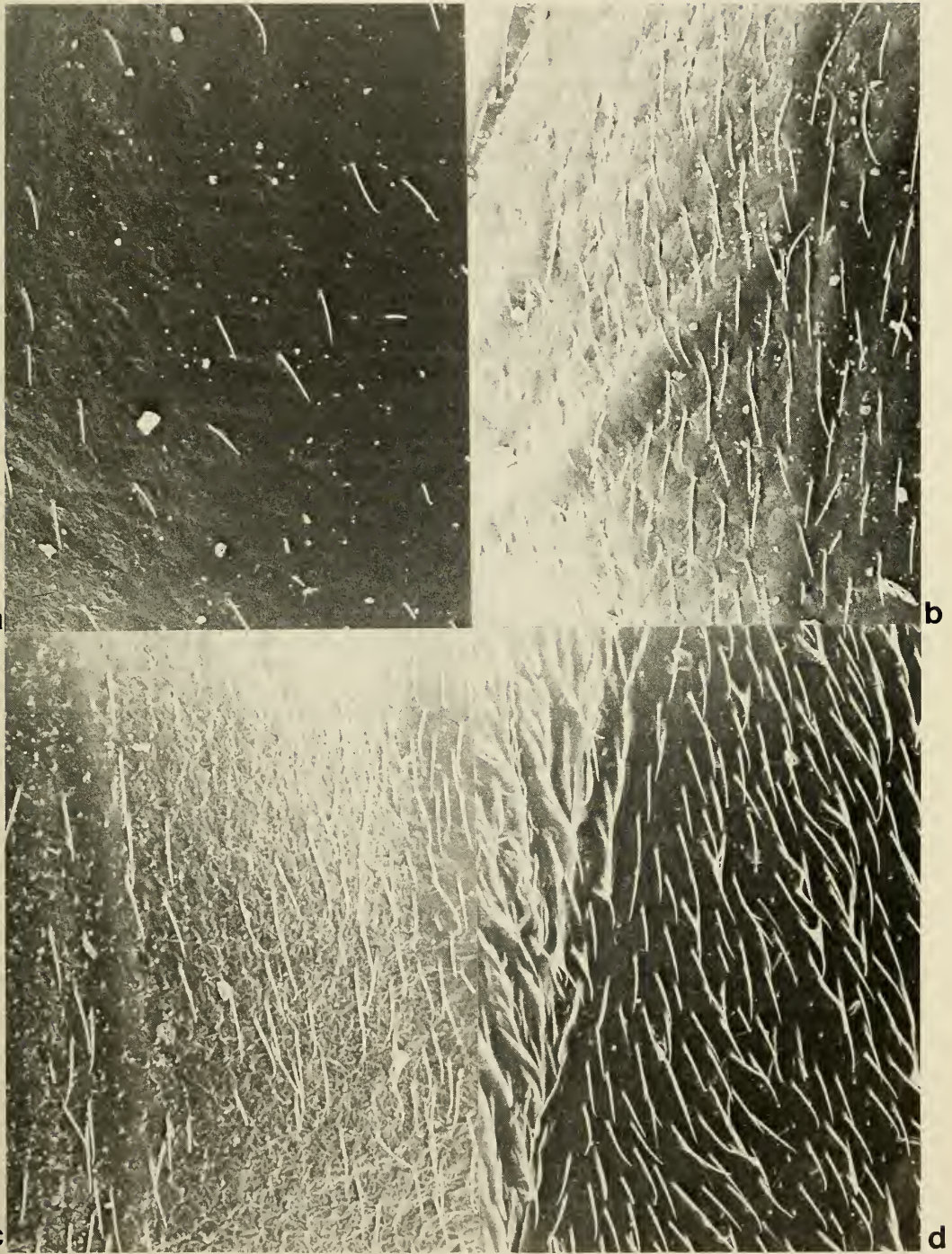

Fig. 21. *Salda* species scanning micrographs of mid part of corium to show differences in densities of setae (60 $\times$ ). a, *S. morio*, Japan; b, *S. muelleri*; c, *S. littoralis*; d, *S. kiritsjenkoi*.



- right wing parallel-sided (not clearly present in some specimens). Wing dull-black with usually two larger well-demarcated spots on exocorium and some smaller ones on endocorium (fig. 13i); stronger tendency to complete melanism than in the subsp. *connectens*, particularly in specimens from the Caucasus; membrane usually unicolorous smoky black. See remarks at couplet 13, sub *variabilis connectens* . . . . . *variabilis variabilis* (Herrich-Schaeffer, 1835)
- Second antennal segment with very short pubescence and with some erect, somewhat longer setae over entire length of segment. Proximal part of exocorium about as wide as base of endocorium or wider; outline of wing margin regular convex . . . . . 22
22. Erect setae on corium of about same length as the width of third tibia. Colouration of short pubescence of wing mostly golden. Marginal setae along anterior edge of pronotum shorter than diameter of one ocellus. Wing design usually as in fig. 71, drawings 2 and 3; lightish pattern testaceous, not very contrasting; base of clavus rarely with pale spot along claval suture; membrane smoky with dark patches in between the veins; (*Transbaicalica*) . . . . .  
 . . . . . *oblonga oblonga* (Stål, 1858)
- Pubescence of wing clearly shorter than diameter of third tibia. Marginal setae along anterior edge of pronotum longer than or subequal to diameter of one ocellus, rarely shorter. . . . . *jakovleffi* (Reuter, 1891), *mongolica* (Kiritshenko, 1912) and *nivalis* (Lindberg, 1935) (see following discussion).

At the end of this key three species remain which caused some nomenclatorial problems: *M. jakovleffi*, *M. mongolica* and *M. nivalis*. I give the following explanation and hope that my proposal on the nomenclature will prove to be correct.

*M. jakovleffi* (Reuter, 1891). Reuter described this species from Turkestan, Dschiptik, D. Fedtschenko and, judging from his notation "long ♀ 6—7½ mill.", he apparently had the disposal of at least two females. The diagnosis refers to a species without erect setae, with shining head and thorax, and with a number of white spots on the forewing. Reuter pointed out that the species differs from the hirsute *M. scotica*, but that the differences with *M. variabilis* are difficult to describe. So far I could not trace the type material of *M. jakovleffi*, but received

one male and one female from the Reuter coll., labelled Turkestan Dschilarik (about 540 km NE of the type locality), leg. J. Sahlberg. The distribution of the lightish wing spots (fig. 14d, second picture from left) conforms more or less with the description of the type material. Since head and pronotum are rather shiny, it seems logical to attribute the male and female in question provisionally to *M. jakovleffi*. I propose to designate the male as the neotype in case the original specimens will not emerge<sup>1</sup>). The two specimens from Dschilarik possess a character not mentioned by Reuter but of possible importance for identification. The laterofrontal edges of the pronotum are beset with a fringe of densely packed whitish setae (fig. 13j); the length of these setae is variable in longer series (see below).

*M. mongolica* (Kiritshenko, 1912). I studied one specimen marked with the type indication of the Leningrad Museum. Since it bears exactly the same locality data as given in the original description (Mongolia: decliv. septentr. Altai Mongolici: ripae lacus Kobdo Inferioris (P. K. Kozlov. viii.1899) I take it for granted that it is the specimen on which Kiritshenko based his description. The body dimensions (5.5. mm—2.5 mm) also fit the description, but instead of a male, as indicated, it appears to be a female. I provisionally suggested that this single type specimen might be conspecific with *M. jakovleffi* as conceived above.

The anteromarginal fringe of setae on the pronotum is not well-developed, but as mentioned before, this character also greatly varies in other material from Mongolia. Additional material from Mongolia seen by me originates from the following localities: SE Arakhangaj, Sharagoldzi (Shargoldzuty-gol) river, 20—40 km NNE Bajan Khongor, 1 ♀, 25.vii.1926, leg. Kiritshenko; Ongiin (Ongin)-Gol river, upper part, 50 km NNW Arvaj-Kheer, 5 ♂ 4 ♀, 14.vii.1926, leg. Kiritshenko (together with *M. oblonga*; Bajanchonger aimak, Changaj Mts Somon Zag, river Zaggol, 2100 m, 2 ♂ 1 ♀, 18.vii.1966, expedition Kaszab (Hoberlandt, 1971b, referred to the males (loc. no. 79) as *M. oblonga* and to the female (log. no. 708) as *M.*

<sup>1</sup>) Dr Kerzhner informed me very recently that Dr A. V. Sviridov let him know, in a letter of 11.viii.1985, that the type of *M. jakovleffi* is in the Zoological Museum of the Moscow University; its length is 6.2 mm, the sex is not indicated, and it is labelled: "Dzhiptyk" (in Cyrillic characters), and "*Acanthia jakowleffi* Reut".



*mongolica*. This material is plotted on map 2, provisionally as *M. mongolica*, although I initially was inclined to consider them conspecific with *M. jakovleffi*. After correspondence with Dr Lindsog I now adopt a more conservative attitude. Recent expeditions made in Mongolia and China probably contain large samples of the *jakovleffi* complex. Scrutinizing this material might solve whether some minor differences revealed between true *M. jakovleffi* and the sparse material of *M. mongolica* at hand are constant enough to uphold *M. mongolica* as a valid taxon (species or subspecies).

*M. nivalis* (Lindberg, 1935) (comb. nov.; described as *Acanthia nivalis*). The type locality of

this species is Kashmir, Tehrong valley near Siachen glacier, 4125 m, 20—26.vi.1929, leg. J. A. Sillem, Netherlands Karakorum expedition. The type material located in the Zoological Museum Amsterdam consists of one female and four larvae. The second adult mentioned in the original publication could not be traced. Although the single female at hand is in a teneral condition, some characters match the series I could study from mountainous areas north of Kashmir, which differs from *M. jakovleffi*. Such characters are: dull dorsal cuticle, more dense silvery adpressed setae, and rather porrect anteclypeus (fig. 14g). Despite of the incomplete information on the type material of *M. nivalis* I am

	<i>jakovleffi</i>	<i>nivalis</i>
size and shape	generally larger, male less slender, female more slender	generally smaller, male more slender, female less slender
length male	5.0—6.0 mm (mean <u>5.4</u> ) (n = 13), width 2.0—2.4 mm (mean <u>2.2</u> ); ratio l/w 2.0	4.5—5.0 mm (mean <u>4.7</u> ) (n = 13), width 1.9—2.7 mm (mean <u>2.1</u> ); ratio l/w 2.24
length female	6.0—7.0 mm (mean <u>6.4</u> ) (n = 11), width 2.6—2.9 mm (mean <u>2.8</u> ); ratio l/w 2.3	5.1—6.0 mm (mean <u>5.5</u> ) (n = 13), width 2.3—2.8 mm (mean <u>2.6</u> ); ratio l/w 2.1
membrane	fully developed	slightly reduced
general colour	black	ashy black
head and pronotum	rather shiny	rather dull
adpressed setae of corium	usually greyish or golden, not striking	silvery and dense (fig. 15a)
eunomy of wing	fig. 14d	fig. 14e <sup>1</sup> )
longitudinal spot in basal half of endocorium	undivided in pale specimens, often parallel with adjacent spot of exocorium	subdivided; marginal spot halfway exocorium (see arrow) mostly present
head in front of eyes	less porrect (fig. 14h, left)	more porrect (fig. 14g, left) due to bulging anteclypeus and more transverse swelling above anteclypeus (fig. 14g, right)
parandria	widely incised (fig. 12j)	incision narrow (fig. 12k)
paramere	with broad processus sensuialis and regular external outline (fig. 12h)	with pointed processus sensuialis and somewhat undulated external outline (fig. 12g)

<sup>1</sup>) Dr Kerzhner wrote me that the variability of wing design is more diversified than presented in fig. 14e.

more inclined to treat the material listed below as *M. nivalis*, rather than to describe it as a new species. Before having studied the type of *M. nivalis* I named this species in 1960, in manuscript, as *Saldula horvathi*, and I misused this name as nom. nud. in one of the chapters of my book (Cobben 1968: 20) dealing with the eggs of Heteroptera.

Making allowance for some mentioned nomenclatorial uncertainties, the differences between *M. jakovleffi* and *M. nivalis* can be tabulated as above.

The material verified by me, mostly present in the Leningrad Coll. and the Coll. Yu. Popov, Moscow, is plotted on map 2; some additional symbols have been added on map 2 in accordance with recent information supplied by Dr Kerzhner.

#### *M. jakovleffi*:

Kirghizia, Tien Shan, Kirghizskij Ridge (= Aleksandrovskij Ridge), gorge Kenkol, 4 ♂ 1 ♀, 17.vii.1930, leg. V. Bianchi; idem, Kirghizskij ridge, Frunzenskaja province (= Semirechenskaja province), 3800 m, 1 ♀, 15.vii.1910, leg. Kiritschenko; idem, Terskej Alatau Ridge (southern side of eastern part of Ridge), Kujlu river (100 km SE Issyk-Kul lake), 1 ♂, 24.vi.1902, leg. Saphozhnikov, idem, Terskej Alatau Ridge, Karagatuz river, 1 ♂, 26.vi.1902, leg. Sapozhnikov; idem, Terskej Alatau, Karasaj river (the Upper Naryn river, 80 km S of Issyk-Kul lake), Pokrovskie syrts (plateau), 1 ♂ 2 ♀, 29.vii.1965, leg. R. Zlotin; idem, Terskej Alatau Ridge, Karasaj river, 1 ♂, 14.viii.1953, leg. D. Panfilov; idem, Fergansky Ridge (Nw part), Kizylunkur river (the Upper Karaunkur river), 20 km N of Arslanbob, 1 ♂, 8.viii.1958, leg. Yu. Popov. Syrt Arabel, 1 ♂ 1 ♀, no further data, type locality of var. *moerens* Horv., 1904; Djergalan-Tjuk, leg. Almasy, no further data. Kazakhstan, Tien Shan, Zailjiskij Alatau Ridge, Bolshaja Almaatinka river (15—20 km S Alma-Ata), 3 ♀, 25—28.vii.1928, leg. Shnitnikov; idem, Saur Ridge, Karasu river (the Upper Kenderlyk river; 50 km SE Zaisan lake, 9 ♂ 6 ♀, 18.vi.1965, leg. Yu. Popov, 3 ♂ 3 ♀, 20.vi.1965, leg. I. Sukatsheva. Usbekistan, Tshimagan near Tashkent, 1 ♀, 13.vii.1924, leg. Martynova; idem, Tshimagan Mt, Tian-Shan, 2000 m, 5 ♂, 9.vi.1982, leg. P. Štys. leg. Almásy. Tadzhikistan, Pamiro-Alaj Alajskaja valley (eastern part), near Irkeshtam, 1 ♀, 20.vi.1960, leg. I. Lopatin; idem, Kzyl-Rabat, 1 ♀, 11.vii.1960, leg. Lopatin; idem, Murgab, 1 ♂, 24.vi.1937, leg. Luppova & Redikortsev.; Altai, Tshagan-Uzun—Taldur, 6.viii.1912, leg. Sushkin; Shavoz, river Shakh dara, 2 ♂, 10.vi.1956, leg. Zhelokhovtsev.

#### *M. nivalis*:

Type-locality: Kashmir, Tehrong Valley. Kirghizia, Kirghizskij ridge (= Aleksandrovskij Ridge), Frunzenskaja province (= Semirechenskaja province),

3800 m, 1 ♀, 15.vii.1910, leg. Kiritschenko; idem, Tien Shan, Chatkalskij (Tschatkalskij) Ridge (NE part), Sary-Chilek Lake, 2500 m, 1 ♂, 13.viii.1957, leg. Yu. Popov; idem, N. Park, Ala-Archa nr. Frunze, 2200—2800 m, 14 ♂ 13 ♀, 22.vi.1982, leg. P. Štys; idem, 2100 m, 1 ♂ 1 ♀, 6—9.vii.1976, leg. J. Král; Fergana mer., Alai, Artschi-Bashi, large series, 12.vi.1908, leg. Kiritschenko; Syrt Arabel, leg. Almásy, 2 ♀, no further data. Kazakhstan, Zailjiskij Alatau Ridge, gorge Gorelnyi (15—20 km S Alma-Ata), 2000 m, 1 ♀, 24.viii.1958, leg. D. Panfilov.

It appears from the distribution pattern now known (map 2) that *M. nivalis* and *M. jakovleffi* are exclusively mountainous species (registered altitudes from 2000—3800 m with ranges coinciding in the Kirghizia area (37—45° latitude). Some locality data and collecting dates are even the same for both species. Dr Kerzhner informed me that both were collected near Alma-Ata in the same valley, but at different sites. The poorly explored mountains at lower latitudes disclosed so far only one locality of *M. nivalis* (35°) and two females from 27.5° latitude (Buthan, 20 km S of Thimphu, 2300 m, 18.v.1972, Bhutan expedition Nat. Hist. Mus. Basel) which belong to the *jakovleffi-mongolica* complex. The range of *M. nivalis* apparently does not extend to the Mongolian mountain chains, whereas the range of *M. jakovleffi* seems to continue into W. Mongolia, either with conspecific populations or with a very close relative (*M. mongolica*, see above).

#### COMMENTS ON THE ZOOGEOGRAPHY OF *MACROSALDULA*, *SALDA*<sup>1)</sup>, AND *TELOLEUCA*

The ancestors of these three genera apparently originated somewhere in the Palaearctic Region. Only two species of *Macrosaldula* occur in the Nearctic Region (Alaska), viz. *M. rivularia* Sahlb. and *M. monae* Dr. The latter species is only known from Alaska, whereas *M. rivularia* is one of the very few *Macrosaldula* species of which the range extends into the arctic zone (maps 1, 2). The characters of both species, with only one exception, conform with those of Palaearctic *Macrosaldula*. *Salda littoralis* is the only Holarctic species of the genus. With respect to one phylogenetically most important male genital character which is shared by all Old World species, it is more plesiomorphic than the remaining seven exclusively New World species.

<sup>1)</sup> *Salda henschi* Reut. and *S. sahlbergi* Reut. are left out of account, since Dr P. Lindskog is revising this couple of species.

Of the genus *Teloleuca*, the sister group of *Saldida*, two of the four Eurasian species also live in the northern part of the New World. This three-fold picture speaks well for a common migration route from the Old World across the Bering Strait after separation of the northern continents.

Combining the Eurasian distribution patterns (maps 1—4) the broad band area from Central Europe across Siberia, which is practically without any records of the saldids discussed, becomes apparent. This absence of records certainly coincides with paucity of sampling. The distribution maps of Gerridae (Kanyukova, 1982) reveal a rather similar pattern, although this group of waterstriders seems to have been explored better than shorebugs in the European part of the USSR. It may, however, be expected that even after more extensive exploration of the West Siberian lowlands, the general distribution patterns of the species treated in the present paper will not change markedly.

The distribution patterns of maps 1—4 make at first sight clear that species of the three genera considered here are predominantly mountainous (note the absence of data from the Ural) and that the largest number of species is found in Central Asia, E. Siberia + Mongolia and the Far East (8(3), 11(3) and 9(2) species, respectively; numbers between brackets refer to endemic species). From Japan seven species are presently known of which two *Macrosaldula* species seem to be restricted to this archipelago (an additional species from Japan will be described by Dr J. Polhemus (in litt)). The European part of the USSR harbours six to seven species, of which only *M. scotica* (Curt.) and *M. variabilis* (H.—S.) are typical European elements. Few species are confined to the Mediterranean region: *M. heijningeni* Cobben and *M. madonica* Seid.

It is too early to discuss the ecological diversifications of the various eastern species, because locality data are not detailed enough as regards habitat characteristics and altitudinal stratifications. Some species are labelled as occurring in the same locality, such as *M. inornata* and *M. variabilis*, *M. variabilis* and *M. scotica*, *S. muelleri* and *S. kiritshenkoi*, and *S. micans*, *S. splendens* and *S. morio*. Small-scale ecological displacements are predictable in such cases. Of great interest is to know more of the habitat requirements of the atypical *Macrosaldula roborowskii* which is only known from two localities (map 1) in W China. Its *Chartos-*

*cirta*-like facies suggests a habitat which might be quite different from those of its congeners which generally inhabit stony banks along streams.

Saldidae, constituting a uniform group of wet-soil-dwelling, carnivorous Heteroptera exhibiting a large amount of wing-polymorphism, are as ideal for eco-geographical studies as Carabidae are among Coleoptera. It is hoped that the present taxonomic contribution will foster large scale collections and detailed field observations of shore bugs in the vast Asian continent.

#### ACKNOWLEDGEMENTS

The preparation of this paper would not have been possible without the help of Dr I. Kerzhner (Zoological Institute, Leningrad), who spent much time in translating and mapping the Russian locality data. I thank him very much for his continuous interest in this project and for his generosity in sending material all over again. I thank Dr Lindskog and Dr Štys for their comments on the manuscript, and Dr Polhemus for permission to list some records of species collected by him in Japan in 1980. The assistance of the following colleagues in supplying material is greatly acknowledged: M. Brancucci (Basel), W. R. Dolling (London), S. Drosopoulos (Athens), J. Duffels (Amsterdam), K. K. Günther (DDR, Berlin), H. Hasagawa (Ibaraki), E. Heiss (Innsbruck), L. Hoberlandt (Prague), J. Lattin (Corvallis), P. Lindskog (Stockholm), J. Martens (Mainz), S. Miyamoto (Fukuoka), R. Poggi (Genoa), J. Polhemus (Englewood), Yu. Popov (Moscow), R. Remane (Marburg), M. Satô (Tokyo), A. Soós (Budapest), P. Štys (Prague), M. Tórnókuni (Tokyo), T. Vásárhelyi (Budapest).

#### REFERENCES

- Asahina, S., & H. Hasegawa, 1951. Insects of the Oze District, I. — *Oyo-Dobutsu* 16: 184—189.
- Benedek, P., 1970. The semiaquatic Heteroptera in the Carpathian Basin with notes on the distribution and the phenology of the species. — *Faun. Abh. Mus. Tierk. Dresden*. 3 (6): 27—49.
- Cobben, R. H., 1957. Beitrag zur Kenntnis der Uferwanzen (Hem. Het. Fam. Saldidae). — *Ent. Berichten* 17: 245—257.
- Cobben, R. H., 1959. Notes on the classification of Saldidae with the description of a new species from Spain. — *Zool. Med., Leiden* 36: 303—316.
- Cobben, R. H., 1960. Die Uferwanzen Europas, Hemiptera — Heteroptera, Saldidae. — In: *Sti-*



- chel, *Illustrierte Bestimmungstabellen der Wanzen*. II. Europa 3: 209—263.
- Cobben, R. H., 1961. A new genus and four new species of Saldidae (Heteroptera). — *Ent. Berichten* 21: 96—107.
- Cobben, R. H., 1968. Evolutionary trends in Heteroptera. Part I. Eggs, architecture of the shell, gross embryology and eclosion, 475 pp. — Centre for Agricultural Publishing and Documentation, Wageningen.
- Cobben, R. H., 1980a. The Saldidae of the Hawaiian archipelago (Hemiptera: Heteroptera). — *Pacific Insects* 22 (1—3): 1—34.
- Cobben, R. H., 1980b. On some species of *Pentacora*, with the description of a new species from Australia (Heteroptera, Saldidae). — *Zool. Med., Leiden* 55 (10): 115—126.
- Cobben, R. H., in press. New African Leptopodomorpha (Hemiptera, Heteroptera). — *Revue de Zoologie africaine*.
- Drake, C. J., 1954. New Saldidae (Hemiptera) from the Old World. — *J. Washington Acad. Sci.* 44 (6): 194—197.
- Drake, C. J., & L. Hoberlandt, 1951. Catalogue of genera and species of Saldidae (Hemiptera). — *Acta Ent. Mus. Nat. Pragae* 26 (376): 1—12 (1950).
- Filippi, N., 1957. Contributo alla conoscenza delle Salde mediterranee con particolare riguardo alla fauna Italiana. — *Boll. Mus. Civ. Stor. Nat. Venezia* 10: 15—46.
- Hasegawa, H., 1954. An annotated list of Hemiptera from the Ozegahara Moor. — *Sci. Res. Ozegahara Moor* 1954: 746—757.
- Hasegawa, H., 1960. Heteroptera of Niigata Prefecture, Japan. — *Bull. Nagaoka Mun. Sc. Mus.* 1: 53—59.
- Heiss, E., 1972. Zur Heteropterenfauna Nordtirols (Insecta: Heteroptera) II. Aradoidea + Saldoidea. — *Ber. Nat.-Med. Ver. Innsbruck* 59: 73—92.
- Hiura, I., 1967. Biogeographical studies on the aquatic and semiaquatic Heteroptera of Japan, 1. A list of specimens in the collection of the Osaka Museum of Natural History, with some notes on their geographical distribution. — *Bull. Osaka Mus. Nat. Hist.* 20: 65—81.
- Hiura, I., 1968. Biogeographical studies on the aquatic and semiaquatic Heteroptera of Japan, 2. Materials taken in Hokkaido in 1967. — *Bull. Osaka Mus. Nat. Hist.* 21: 13—17.
- Hoberlandt, L., 1948. Results of the Zoological Scientific Expedition of the National Museum in Praha to Turkey. 2. Hemiptera — Heteroptera. 1. The aquatic and semiaquatic Heteroptera of Turkey. — *Acta Ent. Mus. Nat. Pragae* 26 (351): 1—74.
- Hoberlandt, L., 1971a. Results of 1st and 2nd Mongolian — Czechoslovak entomological and botanical expedition to Mongolia, No. 25: Heteroptera (2): Veliidae, Gerridae and Saldidae. — *Acta Faun. Ent. Mus. Nat. Pragae* 14 (164): 139—142.
- Hoberlandt, L., 1971b. Results of the zoological explorations bij Dr. Z. Kaszab in Mongolia 191. Heteroptera (2): Saldidae. — *Acta Faun. Ent. Mus. Nat. Pragae* 14 (165): 143—152.
- Hoberlandt, L., 1977. Distributional data on Saldidae (Heteroptera) in Czechoslovakia with a taxonomic note on *Salda sahlbergi* Reuter and *Salda henschi* (Reuter). — *Acta Ent. Mus. Nat. Pragae* 39: 139—158.
- Hoffmann, W. E., 1933. A preliminary list of the aquatic and semi-aquatic Hemiptera, Chosen (Korea) and Indo-China. — *Lingnan Science Journal* 12, suppl.: 249.
- Horváth, G., 1884. Diagnoses Hemipterorum. — *Term. Fuzetek* 8: 315—320.
- Horváth, G., 1887. Notes additionnelles sur les Hémiptères — Héteroptyères des environs de Gorice (Illyrie). — *Rev. Ent.* 6: 68—74.
- Horváth, G., 1888. Matériaux pour servir à l'étude des Hémiptères de la Faune paléarctique. — *Rev. Ent.* 7: 168—189.
- Horváth, G., 1901. Hémiptères du voyage de M. Martinez Escalera dans l'Asie mineure. — *Term. Fuzetek* 24: 469—485.
- Jakovlev, A., 1889. Hemiptera Heteroptera Irkutensia nova. — *Horae. Soc. Ent. Rossicae* 23 (1—2): 66—69.
- Jakovlev, A., 1890. Zur Hemipteren Fauna Russlands und der angrenzenden Länder. — *Horae Soc. Ent. Rossicae* 24: 242—243.
- Jakovlev, A., 1905. Hémiptères — Héteroptyères nouveaux de la faune paléarctique 14. — *Rev. Russe Ent.* 5: 198—202.
- Jordan, K. H. C., & A. Wendt, 1938. Zur Biologie von *Salda littoralis* L. (Hem. Het.). — *Stettiner Ent. Zeitung* 99 (1—2): 273—292.
- Josifov, M., 1957. Forma macroptera von *Halosalda lateralis* Fall. (Heteroptera, Saldidae). — *Acta Ent. Mus. Nat. Pragae* 31 (470): 69—71.
- Josifov, M., 1961. Die halobionten und halophilen Heteropteren an der Schwarzmeerküste. — *Isvestia Zool. Inst., Mus. Sofia* 10: 1—37.
- Josifov, M., 1970. Ergebnisse der Albanien — Expedition 1961 des Deutschen Entomologischen Institutes. 82. Beitrag. Heteroptera. — *Beitr. Ent.* 20 (7—8): 825—956.
- Josifov, M., 1976. Artbildung bei den Heteropteren im Mittelmeerraum als Folge der postglazialen Disjunktion ihrer Areale. — *Acta Zool. Bulg.* 4: 11—22.
- Josifov, M., & J. M. Kerzhner, 1967. Heteroptera von der Mongolischen Volksrepublik. — *Fragmenta Faunistica, Polska Akad. Nauk* 14 (1): 1—5.
- Kanyukova, E. V., 1982. Waterstriders (Heteroptera, Gerridae) of the fauna of the USSR. — *Trudy Zool. Inst. Akad. Nauk SSSR* 105: 62—93.
- Karnecká, H., 1974. Variability and diagnostic value of genitalia in *Saldula saltatoria* and *Saldula palipes* group (Heteroptera, Saldidae). — *Acta. Ent. Bohemoslovaca* 71 (1): 11—19.
- Kerzhner, I. M., 1978. Heteroptera of Saghalien and Kurile Islands. — *Trudy Biol.* — pochv. Int.

- Dalnerost. neuch. Centra an SSSR, Vladivostok, N.S. 50 (153): 31—57.
- Kerzhner, I. M., & T. L. Jaczewski, 1967. Keys to the insects of the European USSR. Vol. I. Apterygota, Palaeoptera, Hemimetabola. Ed.: G. Ya. Bei Bienko. 19. Order Hemiptera: 655—845, Saldidae: 684—688. Academy of Sciences of the USSR. (Translated from Russian. Israel Program for Scientific Translations, Jerusalem, 1967.)
- Kiritshenko, A. N., 1912a. Ad cognitionem generis *Acanthia* Latr. (Hemiptera — Heteroptera). — Ann. Mus. Zool. Acad. Sci., St. Petersburg 16: 539—549.
- Kiritshenko, A. N. 1912b. Hemiptera — Heteroptera turanica nova. — Rev. Russe Ent. 12: 377—389.
- Kiritshenko, A. N. 1951. Hemiptera of the European part of the USSR: 1—424. — Moskva-Leningrad.
- Leston, D., & T. R. E. Southwood, 1964. A new subgenus of *Saldula* Van Duzee, 1914 (Hem. Saldidae). — Ent. Mon. Mag. 25: 80.
- Lindberg, H., 1922. Verzeichnis der von John Sahlberg und Unio Saalas in den Mittelmeergebieten gesammelten semiaquatischen und aquatischen Heteropteren. — Not. Ent. 2: 15—19.
- Lindberg, H., 1934. Verzeichnis der von R. Malaise in Jahre 1930 bei Vladivostok gesammelten Heteropteren. — Not. Ent. 14: 1—23.
- Lindberg, H., 1935. Hemiptera. In: P. C. Visser et al. (eds.), Wissenschaftliche Ergebnisse der Niederländischen Expedition in der Karakorum und die angrenzenden Gebiete 1922, 1925 und 1929—30: Insects: 205—425. — Leipzig.
- Lindskog, P., 1975. Taxonomy and systematics of some species groups of *Saldula* Van Duzee, with a discussion of riparian — terrestrial shifts in the Saldidae (Heteroptera). — Zool. Scripta 4: 159—174.
- Linnaeus, C., 1758. Systema Naturae. Edition 1. 2 vol., pp. 2 + 824, Stockholm.
- Oshanin, B., 1912. Katalog der Palaearktischen Hemipteren (Heteroptera, Homoptera — Auchenorrhyncha und Psylloidea), 187 pp. — R. Friedlander und Son, Berlin.
- Polhemus, J. T., 1977. The biology and systematics of the Saldidae of Mexico and Middle America. PhD. Dissertation, University of Colorado, Boulder.
- Puton, A., 1880. Synopsis des Hémiptères de France. I, 3e partie, Reduvides, Saldides, Hydrocorises: 160—245.
- Reuter, O. M., 1891. Species novae generis *Acanthia* F., Latr. — Rev. Ent. 10: 21—27.
- Reuter, O. M., 1895. Species palaearcticae generis *Acanthia* Fabr., Latr. — Acta, Soc. Sci. Fennica 21 (2): 1—58.
- Reuter, O. M., 1912. Zur generischen Teilung der palaearktischen und nearktischen Acanthiaden. — Ofv. Finska Vet.-Soc. Forh. 54 (A) 12: 1—24.
- Sahlberg, J., 1878. Bidrag till nordvestra Sibiriens Insektfauna; Hemiptera — Heteroptera insamlade under Expeditionerna till Ohi och Jenasej 1876 och 1877. — Kongl. Svenska Vet.-Akad. Handl., Stockholm 16 (4): 1—39.
- Sahlberg, J., 1880. Bidrag till det Nordenfjeldske Norges insektfauna. I. Hemiptera. — Vidensk.-Selsk. Christiania Forh. 1 (9): 1—13.
- Scudder, G. G. E., 1958. On *Salda morio* Zett. and *S. muelleri* (Gmel.) (Hem. Saldidae) in Britain. — Ent. Mon. Mag. 94: 190—192.
- Southwood, T. R. E., & D. Leston, 1959. Land and water bugs of the British Isles, 436 p. — London: Wayside & Woodland Series.
- Stål, C., 1858. Beitrag zur Hemipteren-Fauna Sibiriens und des russischen Nord-Amerika. — Stettiner Ent. Zeitung 19: 175—198.
- Vinokurov, N. N., 1975. Shorebugs of the genus *Micracanthia* Reut. (Heteroptera: Saldidae) in the fauna of the USSR. — Zool. J. Acad. Sci. USSR 54 (9): 1406—1409.
- Vinokurov, N. N., 1978. Two new species of bugs (Heteroptera: Saldidae, Miridae) from the Asian regions of the USSR. — Entom. Obozr. 57 (2): 333—336.
- Vinokurov, N. N., 1979a. Heteroptera of Yakutia. — Opredeliteli Fauna SSSR 123, Saldidae: 61—71.
- Vinokurov, N. N., 1979b. Bugs of the family Saldidae (Heteroptera) of the Mongolian People's Republic. In: Insects of Mongolia, no. 6: 25—33.
- Vinokurov, N. N., 1979c. New species of Hemiptera. *Saldula kuvrentzovi* sp.n. (Hemiptera, Saldidae) from the south of far eastern USSR. — Trudy Ent. Obsch. 61: 53—56.
- Vinokurov, N. N., 1981. Materials on Saldidae (Heteroptera) of Sakhalin. — Trudy Zool. Inst. Akad. Nauk SSR 92: 11—13.
- Wagner, E., 1960. *Salda nevadensis* nov. spec. (Hem. Het. Saldidae). — Trabajos del Museo de Zoología, N.S. Zoológica 2 (3): 2—4.
- Wagner, E., 1967. Die Heteropteren-Ausbeute der Mongolisch-Deutschen Biologischen Expeditionen 1962 und 1964. Ergebnisse der Mongolisch-Deutschen Biologischen Expeditionen seit 1962. Nr. 22. — Mitt. Zool. Mus. Berlin 43 (1): 53—76.
- Wróblewski, A., 1966. Shorebugs (Heteroptera, Saldidae) of Poland. — Polskie Pismo Ent. 36 (12): 219—302.
- Wróblewski, A., 1968. Klucze do oznaczania owadów Polski. Część XVIII. Pluskwiaki różnoskrzydłe-Heteroptera. Zeszyt 3 Leptopodidae, Nabrzeżkowate-Saldidae. — Polskie Towarzystwo Entomologiczne 58: 3—35.
- Wu, C. F., 1935. Catalogus insectorum sinensium. Vol. II. Hemiptera, etc., 634 pp. — Peiping.
- Zetterstedt, J. W., 1840. Insecta Lapponica, 1140 cols. — Lipsiae.



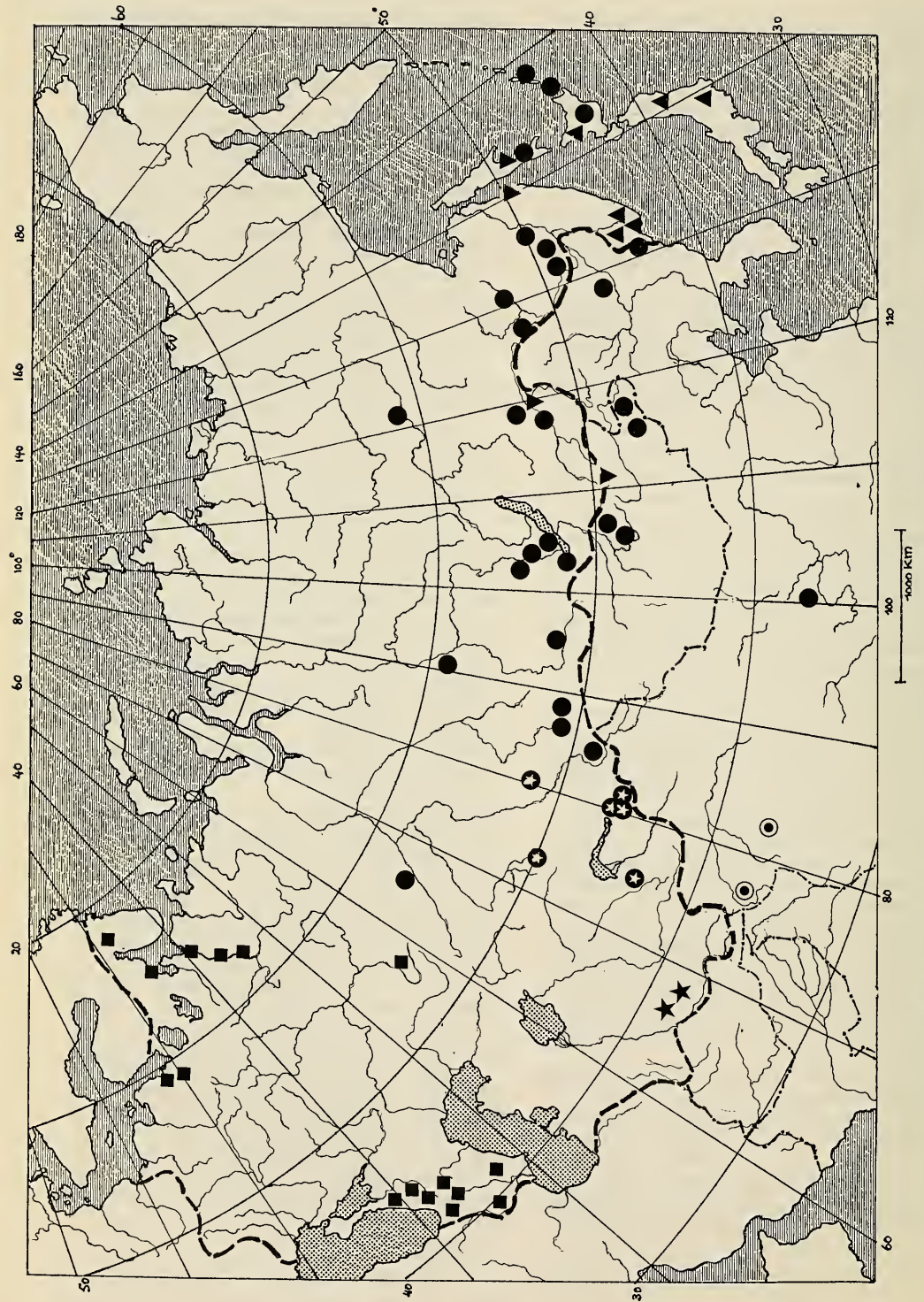

Map 1. Known distribution patterns of some *Saldulid* and *Macroscaldulid* species in the Palearctic region.



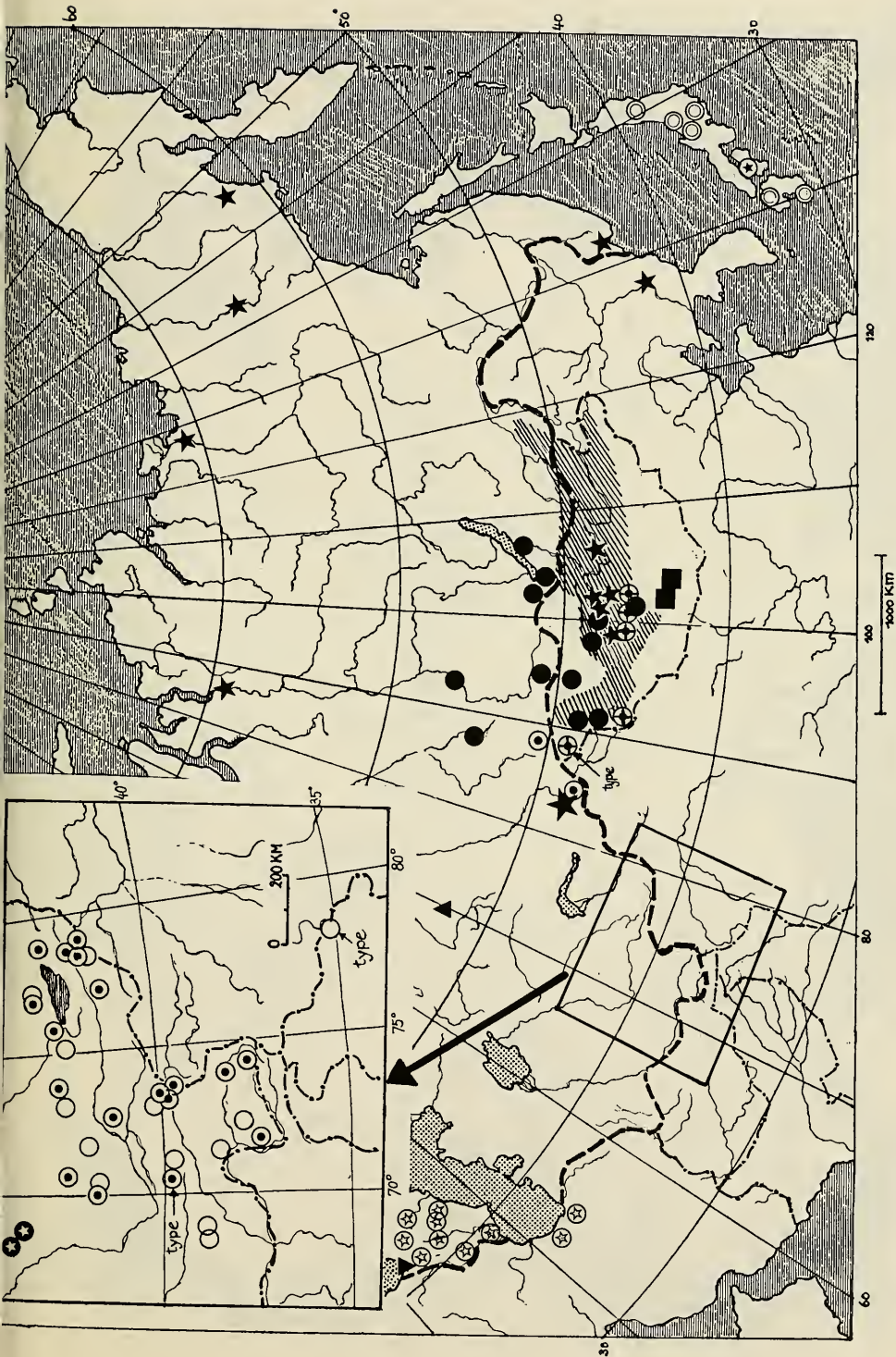

▼ = *Macrosaldula klavialis* sp. n., ⊙ = *M. jakovlevi* Reut., ■ = *M. kaszabi* Hoberl., ⊕ = *M. kerzhneri* sp. n., ▲ = *M. kokshetavica* sp. n., ⊕ = *M. miyamotoi* sp. n., ⊕ = *M. mongolica* Kir.?, ⊖ = *M. nivalis* Lindb., ⊖ = *M. oblonga* Stål., ⊙★ = *M. oblonska acetabularis* subsp. n., ★ = *M. rivularia* Sahlb., ⊙★ = *M. shikokuana* sp. n., ● = *M. simulans* sp. n., ⊕ = *M. variabilis variabilis* H.-S.

Map 2. Known distribution patterns of some *Macrosaldula* species in the USSR and Far East countries. Localities in Scandinavia and Poland have not been mapped.

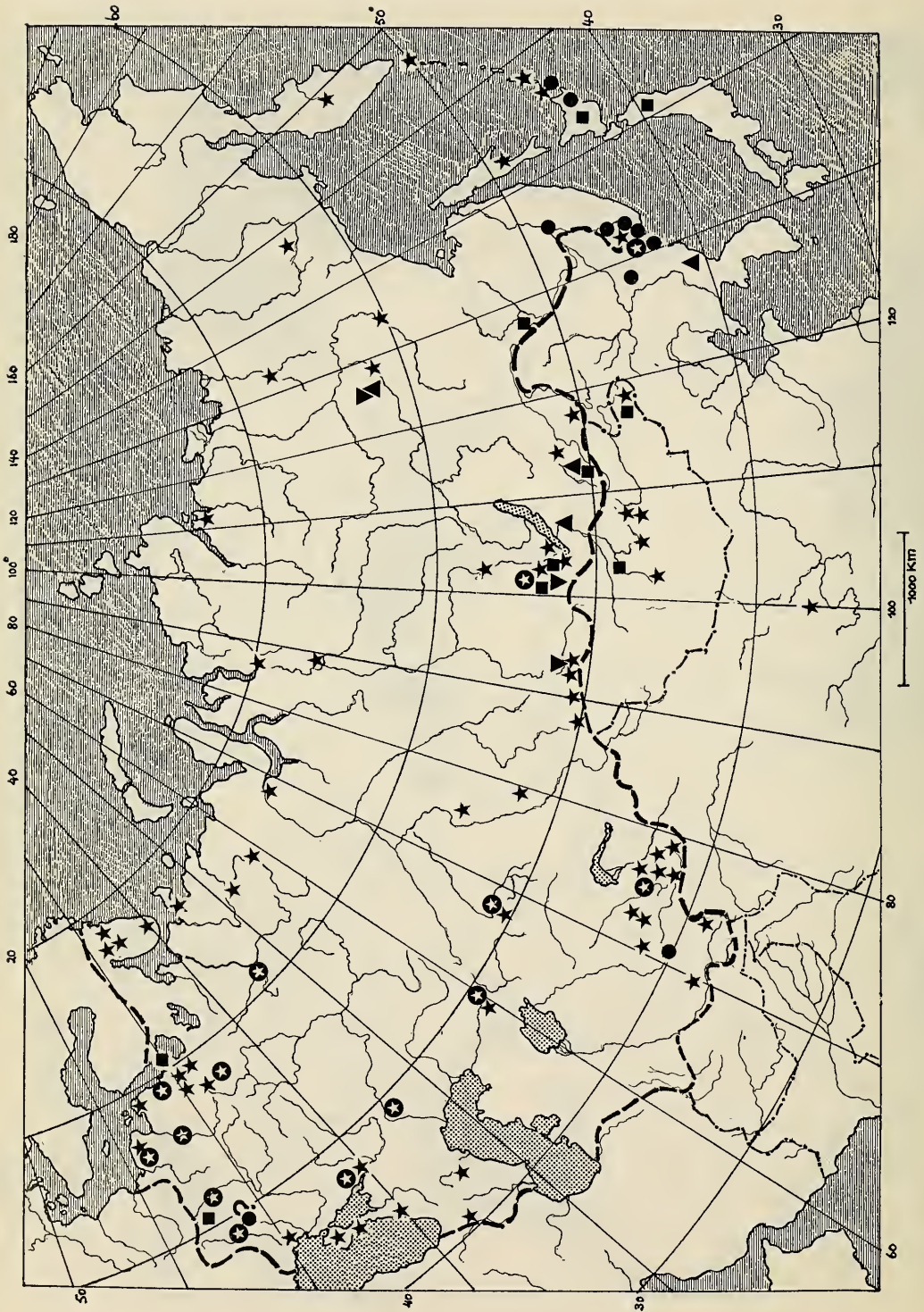

● = *Salda littoralis* L., ★ = *S. micans* Jakovl., ▼ = *S. morio* Zett., ⊕ = *S. splendens* Jakovl.



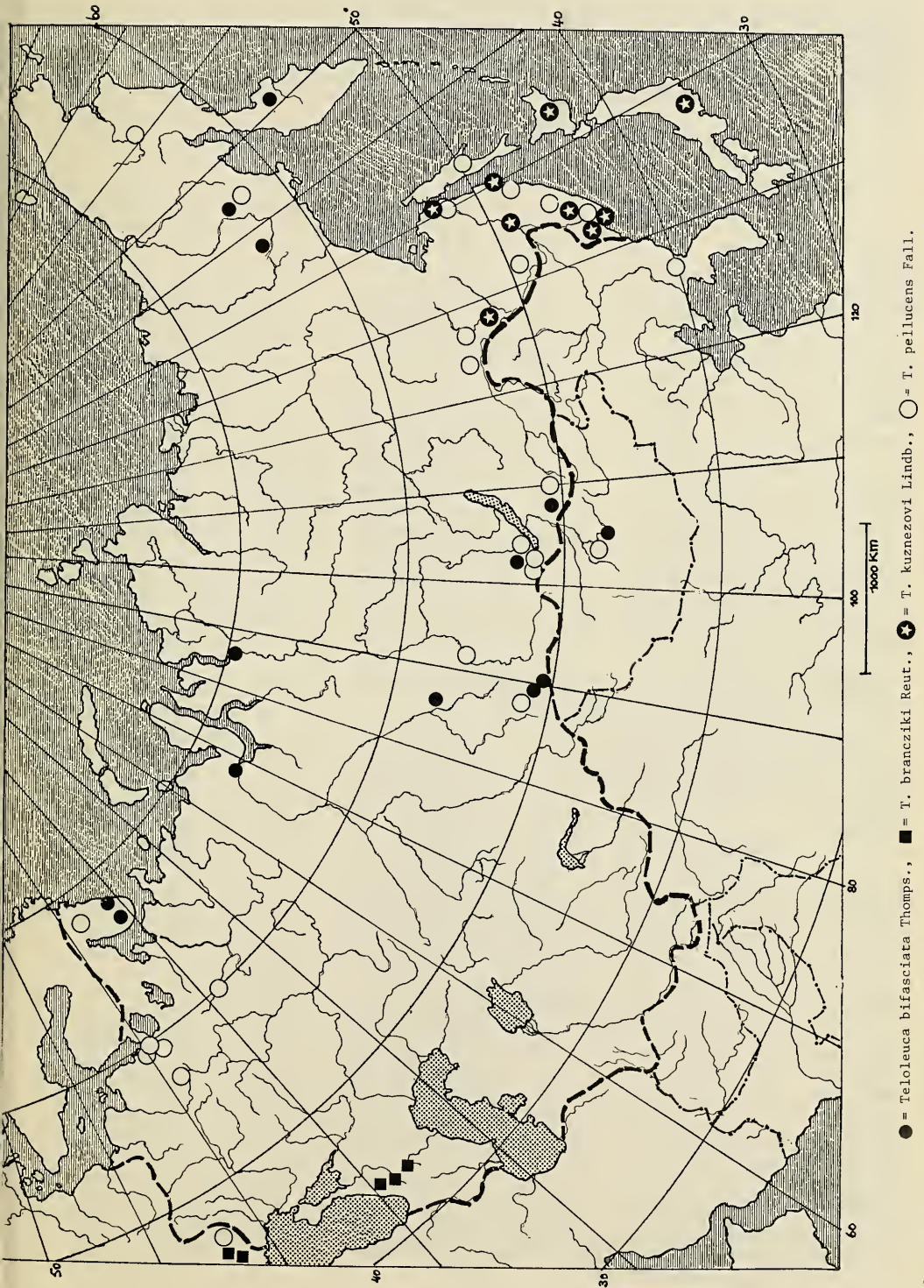

Map 4. Known distribution of *Teloleuca* species in the USSR and Far East countries. Localities in Scandinavia and Poland have not been mapped.



Table 1. Some measurements of *Halosalda*, *Saldula*, *Macrosaldula*, *Calacanthia* and *Salda* species (in mm). Data are presented for only four specimens at the most; when longer series are available more data can be found in the descriptions. The length of antennal segments 3 and 4 is inclusive the proximal intersegmental ring, which creates some variation in the measurements since the internodes are not always fully visible.

species	sex	total length	total width	head					pronotum			antenna				leg 3	
				width	vertex at level of ocelli	frons at narrowest	width	ocellus width	distance between ocelli	length	with of collar	width at the base	1	2	3	4	tibia
<i>Halosalda coracina</i> sp.n.	♂	3.4	1.6	0.96	0.32	0.28	0.04	0.07	0.52	0.56	1.16	0.26	0.68	0.44	0.42	1.60	0.64
	♂	3.6	1.6	0.94	0.36	0.28	0.05	0.05	0.58	0.56	1.20	0.26	0.68	0.44	0.46	1.52	0.68
	♀	3.8	1.9	1.00	0.38	0.32	0.03	0.03	0.54	0.58	1.28	0.28	0.78	0.48	0.44	1.78	0.68
<i>Saldula basegawai</i> sp.n.	♀	3.7	1.8	1.00	0.36	0.32	0.03	0.04	0.52	0.60	1.30	0.28	0.76	—	—	1.72	0.66
	♂	3.05	1.59	0.89	0.34	0.24	0.05	0.05	0.46	0.54	1.15	0.29	0.55	0.41	0.41	1.48	0.51
	♂	3.16	1.70	0.95	0.31	0.24	0.05	0.05	0.49	0.55	1.20	0.29	0.57	0.46	0.45	1.51	0.52
<i>Saldula taiwanensis</i> sp.n.	♀	3.55	1.90	0.94	0.35	0.25	0.07	0.04	0.50	0.58	1.30	0.30	0.62	0.45	0.45	1.59	0.56
	♂	3.5	1.75	1.04	0.40	0.26	0.06	0.04	0.48	0.56	1.32	0.36	0.70	—	—	1.68	0.64
	♂	3.6	1.70	1.04	0.38	0.24	0.06	0.04	0.48	0.56	1.32	0.36	0.68	0.46	0.46	1.64	0.63
<i>Saldula burmanica</i> subsp.n.?	♀	4.0	1.90	1.08	0.40	0.32	0.07	0.04	0.52	0.62	1.44	0.38	0.72	—	—	1.76	0.68
	♂	3.75	1.90	1.04	0.40	0.28	0.07	0.04	0.56	0.60	1.40	0.36	0.70	0.45	0.44	1.76	0.63
	♂	3.60	1.78	1.08	0.41	0.28	0.07	0.04	0.50	0.65	1.36	0.28	0.70	0.48	0.54	1.75	0.63
<i>Saldula sibiricola</i> sp.n.	♂	4.22	1.99	1.16	0.45	0.32	0.05	0.05	0.60	0.72	1.60	0.29	0.75	0.53	0.58	1.95	0.73
	♀	4.14	2.28	1.18	0.48	0.35	0.07	0.05	0.56	0.70	1.63	0.28	0.73	0.50	0.51	1.90	0.75
	♀	3.39	2.10	1.18	0.45	0.34	0.06	0.05	0.56	0.73	1.48	0.28	0.73	0.53	0.57	1.88	0.71
<i>Macrosaldula clavalis</i> sp.n.	♂	4.3	2.1	1.16	0.35	0.28	0.06	0.03	0.66	0.66	1.35	0.38	0.90	0.57	0.60	2.10	0.85
	♀	4.5	2.3	1.20	0.40	0.30	0.06	0.03	0.70	0.70	1.42	0.33	0.90	0.54	0.59	2.15	0.87
	♀	4.9	2.4	1.25	0.42	0.31	0.07	0.03	0.70	0.71	1.55	0.35	1.00	0.62	0.65	2.40	0.96
<i>Macrosaldula inornata</i> sp.n.	♂	4.0	1.7	0.96	0.40	0.32	0.08	0.02	0.46	0.56	1.40	0.28	0.76	0.45	0.45	2.20	0.68
	♀	4.8	2.0	1.04	0.44	0.38	0.08	0.03	0.52	0.72	1.64	0.36	0.88	0.60	0.54	2.44	0.78
	♂	4.3	1.7	1.0	0.44	0.36	0.08	0.04	0.54	0.64	1.44	0.24	0.80	0.54	0.52	2.10	0.68
<i>Macrosaldula kerzhneri</i> sp.n.	♂	4.5	1.8	1.0	0.44	0.36	0.08	0.03	0.54	0.62	1.48	0.24	0.80	0.56	0.54	2.10	0.64
	♀	4.7	2.0	1.06	0.48	0.44	0.09	0.04	0.60	0.72	1.72	0.28	0.90	0.58	0.56	2.52	0.76
	♀	4.9	2.0	1.03	0.52	0.40	0.09	0.04	0.52	0.72	1.64	0.27	0.90	0.58	0.54	2.36	0.69
<i>Macrosaldula koktshetavica</i> sp.n.	♂	5.9	2.4	1.28	0.60	0.36	0.08	0.02	0.70	0.76	1.92	0.52	1.40	0.92	0.84	3.24	1.00
	♀	7.1	3.0	1.38	0.60	0.48	0.09	0.02	0.80	0.80	2.16	0.56	1.60	0.96	0.88	3.92	1.18
	♀	7.2	3.0	1.40	0.64	0.46	0.09	0.03	0.88	0.84	2.16	0.53	1.56	0.92	0.84	3.84	—
<i>Macrosaldula miyamotoi</i> sp.n.	♂	4.7	1.9	1.16	0.48	0.36	0.08	0.02	0.56	0.68	1.56	0.36	0.92	0.54	0.54	2.36	0.88
	♂	4.3	1.9	1.14	0.50	0.34	0.07	0.02	0.56	0.66	1.48	0.36	0.92	0.56	0.54	2.32	0.89
	♀	5.0	2.2	1.20	0.46	0.40	0.09	0.03	0.60	0.72	1.72	0.38	1.02	0.56	0.56	2.48	0.96
<i>Macrosaldula shikokuana</i> sp.n.	♀	5.0	2.1	1.20	0.50	0.40	0.08	0.03	0.60	0.68	1.72	0.32	0.96	0.58	0.54	2.40	0.92
	♂	4.8	1.9	1.04	0.48	0.32	0.08	0.03	0.48	0.64	1.56	0.32	0.86	0.58	0.56	2.24	0.72
	♂	4.4	1.9	0.98	0.38	0.28	0.07	0.03	0.48	0.60	1.52	0.28	0.84	0.46	0.46	2.20	0.76
<i>Macrosaldula simulans</i> sp.n.	♀	5.3	2.3	1.08	0.44	0.32	0.09	0.04	0.52	0.68	1.68	0.36	0.96	0.64	0.60	2.72	0.78
	♂	4.8	2.0	1.04	0.42	0.30	0.08	0.03	0.46	0.64	1.56	0.32	0.92	0.60	0.58	2.36	0.78
	♀	5.4	2.4	1.08	0.40	0.32	0.09	0.03	0.56	0.66	1.72	—	—	—	—	2.64	0.76
<i>Macrosaldula violacea</i> sp.n. Japan	♂	6.3	2.9	1.36	0.56	0.44	0.08	0.02	0.80	0.80	1.88	0.52	1.60	0.98	0.80	3.76	1.08
	♀	6.7	3.0	1.32	0.56	0.42	0.12	0.03	1.12	0.80	2.12	0.52	1.52	0.92	0.84	3.60	1.10
	♀	6.5	2.9	1.32	0.52	0.43	0.10	0.04	0.76	0.84	2.12	0.56	1.60	0.93	0.85	4.00	1.20
<i>Calacanthia grandis</i> sp.n.	♂	5.4	2.1	1.28	0.48	0.30	0.08	0.04	0.62	0.68	1.80	0.52	1.36	0.64	—	2.56	0.98
	♂	5.2	2.1	1.24	0.48	0.29	0.08	0.02	0.64	0.68	1.72	0.48	1.36	0.72	0.68	2.88	0.96
	♀	5.9	2.4	1.24	0.46	0.36	0.09	0.03	0.64	0.72	1.84	0.48	1.44	0.76	0.72	2.96	1.10
<i>Salda kiritshenkoi</i> sp.n.	♀	6.0	2.35	1.24	0.40	0.46	0.09	0.02	0.64	0.72	1.92	0.48	1.32	0.76	—	2.84	1.01
	♂	5.85	2.12	1.30	0.48	0.34	0.1	0.03	0.65	0.75	1.75	0.55	1.50	0.80	0.72	2.94	1.00
	♀	7.5	3.8	1.64	0.78	0.52	0.1	0.08	0.92	1.00	2.40	0.72	1.72	1.00	1.12	4.16	1.28
<i>Salda semi brachypt.</i>	♂	6.0	2.8	1.48	0.49	0.38	0.09	0.04	0.90	0.82	2.05	0.49	1.23	0.78	0.82	3.10	1.25
	♂	5.4	2.8	1.46	0.42	0.32	0.09	0.04	0.92	0.80	2.00	0.48	1.20	0.80	0.80	2.96	1.20
	♀	6.6	3.4	1.72	0.57	0.40	0.10	0.05	1.0	0.98	2.46	0.51	1.34	0.82	0.81	3.55	1.29
♀	6.2	3.4	1.62	0.54	0.43	0.10	0.06	0.92	0.92	2.36	0.50	1.32	0.81	0.81	3.36	1.28	

## REGISTER VAN DEEL 128

\* Een sterretje duidt aan een naam nieuw voor de wetenschap

\* An asterisk denotes a name new to science

## DIPTERA

- abietina, *Plemyia* 206  
 acariphaga, *Ledomyia* 200  
 acerina, *Ledomyia* 200  
*Acodiplosis* 206, 210  
*Ametrodiplosis* 205  
*Aphidoletes* 200  
*Arnoldiola* 205  
*Asphondylia* 202, 204, 205,  
 [206, 210  
*Asteromyia* 206  
*Baldratia* 205, 206  
*betulae*, *Semudobia* 208, 209  
*betulicola*, *Plemyia* 206  
*Brachineura* 196  
*brachyntera*, *Thecodiplosis* 196  
*brassicae*, *Dasineura* 195, 203,  
 [204  
*brevipalpes*, *Semudobia* 209  
*Buhromyiella* 197  
*cardui*, *Ledomyia* 200  
*caricis*, *Antichiridium* 205  
*Camptodiplosis* 197  
*carophila*, *Lasioptera* 203, 204  
*cerealis*, *Hybolasioptera* 203  
*Clinodiplosis* 197  
*Contarinia* 202, 204  
*cornifex*, *Planetella* 208  
*Cystiphora* 206  
*Dasineura* 200, 204, 205  
*deletrix*, *Rabdophaga* 208  
*destructor*, *Mayetiola* 195, 196,  
 [203, 206  
*Dichaetia* 197  
*Dichodiplosis* 197  
*Dryomyia* 206  
*Echinella* 197  
*Endaphis* 200  
*Endopsylla* 200  
*Epimyia* 196  
*Feltiella* 200  
*fischeri*, *Planetella* 208  
*galii*, *Trotteria* 200  
*galiorum*, *Schizomyia* 206  
*Gephyraulus* 200  
*Giardomyia* 197  
*Giraudiella* 206  
*Halodiplosis* 205, 206  
*hartigi*, *Physemocecis* 205  
*Hartigiola* 206  
*heterobia*, *Rabdophaga* 208  
*hieracii*, *Cystiphora* 206  
*Hybolasioptera* 206  
*Jaapiella* 200, 204, 205  
*Janetiella* 205  
*Kaltenbachiola* 200  
*Karshomyia* 197  
*kneuckeri*, *Planetella* 208  
*Lasioptera* 204, 205  
*Lestodiplosis* 200  
*ligustri*, *Trotteria* 200  
*Loewiola* 206, 210  
*Marcrolabis* 200, 204, 205  
*marginata*, *Haplodiplosis* 195,  
 [203  
*Mayetiola* 205, 206  
*Mikomyia* 208  
*Misospatha* 206  
*Monobremia* 200  
*Mycetodiplosis* 197  
*Mycocecis* 197  
*Mycodiplosis* 197  
*nasturtii*, *Contarinia* 203  
*navasiana*, *Dictyomyia* 206  
*Neolasioptera* 204, 205  
*Neomycodiplosis* 197  
*nervorum*, *Rabdophaga* 208  
*niveocincta*, *Lasioptera* 206  
*Oligotrophus* 205  
*oryzae*, *Orseolia* 196  
*Ozirhincus* 206  
*Phaenobremia* 200  
*pilosellae*, *Cystiphora* 206  
*pimpinellae*, *Kiefferia* 203, 204  
*Planetella* 205, 206, 208, 210  
*Polystepha* 202  
*pulchripes*, *Contarinia* 195  
*Rabdophaga* 205, 208, 210  
*raphanistri*, *Gephyraulus* 203,  
 [204  
*Rhizomyia* 196  
*Rhopalomyia* 196, 200, 204,  
 [205, 206, 210  
*rosaria*, *Rabdophaga* 208  
*rosenhaueri*, *Planetella* 208  
*saliciperda*, *Rabdophaga* 208  
*salsolae*, *Dictyomyia* 206  
*sarothamni*, *Asphondylia* 206  
*Semudobia* 200, 208, 209  
*sisymbrii*, *Dasineura* 203, 204  
*skuhrvavae*, *Semudobia* 208  
*steenisi*, *Semudobia* 208, 209  
*Stefaniola* 196, 205, 206  
*striatum*, *Antichiridium* 205  
*subterranea*, *Planetella* 208  
*tami*, *Schizomyia* 206  
*tarda*, *Planetella* 208  
*tarda*, *Semudobia* 208, 209  
*terminalis*, *Rabdophaga* 208  
*Therodiplosis* 200  
*triandraperda*, *Rabdophaga* 208  
*tumorifica*, *Planetella* 208  
*ulmi*, *Physemocecis* 205  
*Wachtliella* 200, 204, 205  
 HETEROPTERA  
*adriatica*, *Salda* 253, 254  
*andrei*, *Saldula* 232  
*angulosa*, *Calacanthia* 242  
*azteca*, *Saldula* 232  
*bouchervillei*, *Saldula* 221, 226  
*brancziki*, *Teloleuca* 252  
*buenoi*, *Salda* 246  
*burmanica*, *Saldula* 223 sqq  
*Chartoscirta* 215, 223  
*cincta*, *Chartoscirta* 223  
 \**clavalis*, *Macrosaldula* 215, 219,  
 [229, 256  
*concolor*, *Halosaldula* 218 sqq  
 \**Coracina*, *Halosaldula* 215,  
 [217 sqq  
*dilutipennis*, *Chartoscirta* 256  
*fletcheri*, *Saldula* 223  
 \**grandis*, *Calacanthia* 215  
 \**hasegawai*, *Saldula* 215, 221

- heijningeni*, *Macrosaldula* 255  
*illinoensis*, *Saldula* 226  
*inoana*, *Saldula* 223  
*\*inornata*, *Macrosaldula* 215,  
 [229, 255, 256, 263  
*jakovleffi*, *Macrosaldula* 215,  
 [232, 260, 262  
*kaszabi*, *Macrosaldula* 229, 256  
*\*kerzhneri*, *Macrosaldula* 215,  
 [232, 256  
*\*kiritshenkoi*, *Salda* 215, 244 sqq,  
 [263  
*\*koktshetavica*, *Macrosaldula*  
 [215, 234  
*koreana*, *Saldula* 232, 240, 256  
*lateralis*, *Halosalda* 218 sqq  
*littoralis*, *Salda* 215, 246, 262  
 ssp. *piechockii* 215, 252  
*madonica*, *Macrosaldula* 232,  
 [258  
*micans*, *Salda* 215, 247, 250,  
 [263  
*Micranthia* 215  
*\*miyamotoi*, *Macrosaldula* 215,  
 [234, 258  
*monae*, *Macrosaldula* 238, 258,  
 [262  
*mongolica*, *Macrosaldula* 215,  
 [232, 260  
*morio*, *Salda* 246, 247 sqq, 250  
*muelleri*, *Salda* 247, 249, 263  
*nevadensis*, *Salda* 215, 252  
*navalis*, *Macrosaldula* 215,  
 [260 sqq  
*nobilis*, *Saldula* 228  
*oblonga*, *Macrosaldula* 215, 232,  
 [260  
 ssp. *acetabularis* 236, 250  
*orbiculata*, *Saldula* 221  
*orthochila*, *Saldula* 225  
*pellucens*, *Teloleuca* 228  
*reuteri*, *Saldula* 228  
*rivularia*, *Macrosaldula* 232,  
 [238, 256, 262  
*roborowskii*, *Macrosaldula* 215,  
 [254, 256, 263  
*saltatoria*, *Saldula* 226  
*scotica*, *Macrosaldula* 232, 258,  
 [263  
*\*shikokuana*, *Macrosaldula* 215,  
 [236, 258  
*\*sibiricola*, *Saldula* 215, 226  
*\*simulans*, *Macrosaldula* 215, 238  
*splendens*, *Salda* 215, 247, 263  
*tadzshika*, *Macrosaldula* 232, 258  
*\*taiwanensis*, *Saldula* 215, 221  
*tibetana*, *Calacanthia* 242  
*uichancoi*, *Saldula* 223  
*variabilis*, *Macrosaldula* 232,  
 [256, 263  
 ssp. *connectens* 258  
*\*violacea*, *Macrosaldula* 215, 238,  
 [256  
**HOMOPTERA**  
*Arfaka* 165  
*\*breddini*, *Prasia* 165, 166, 169,  
 [174  
*culta*, *Prasia* 165, 166, 171  
*Drepanopsaltria* 166, 167  
*faticina*, *Prasia* 165, 166, 169,  
 [170  
*foliata*, *Prasia* 165  
*fulva*, *Arfaka* 166  
*hariola*, *Arfaka* 165, 166  
*Iruana* 165  
*Jacatra* 165  
*Lacetas* 165  
*Lembeja* 165  
*\*nigropercula*, *Prasia* 165, 166,  
 [169, 180  
*Prasia* 165 sqq  
*princeps*, *Prasia* 165, 166, 169,  
 [182  
*Sapantanga* 165  
*\*sarasinorum*, *Prasia* 165, 166,  
 [169, 176  
*\*senilirata*, *Prasia* 165, 166, 169,  
 [186  
*tincta*, *Lembeja* 165, 166  
*\*tuberculata*, *Prasia* 165,  
 [166, 169, 178  
**LEPIDOPTERA**  
*Acalypris* 8, 45  
*admiranda*, *Ectoedemia* 18  
*aegilopidella*, *Ectoedemia* 12,  
 [14, 17, 38, 42, 43, 63, 88  
*agrimomella*, *Nepticula* 66  
*agrimoniae*, *Ectoedemia* 6,  
 [12-14, 17, 27, 64, 66 sqq, 69,  
 [71, 87  
*agrimoniae*, *Nepticula* 66  
*agrimoniella*, *Nepticula* 66  
*albifasciella*, *Ectoedemia* 16, 36,  
 [52 sqq, 55, 56, 58, 59, 91  
*albifasciella*, *Nepticula* 52  
*albifasciella* complex,  
 [Ectoedemia 11, 14, 34, 37, 47,  
 [51, 52 sqq, 64, 88, 91  
*\*algeriensis*, *Ectoedemia* 1, 11,  
 [16, 43 sqq, 47, 88, 90, 91  
*cf algeriensis*, *Ectoedemia* 15,  
 [43, 45  
*alliatae*, *Nepticula* 49  
*\*alnifoliae*, *Ectoedemia* 1, 10, 16,  
 [50, 51  
*amani*, *Ectoedemia* 10, 13, 15,  
 [18, 24-26, 86, 87  
*\*andalusiae*, *Ectoedemia* 1, 12,  
 [15, 16, 41, 42, 47, 90  
*angulifasciella*, *Ectoedemia* 12,  
 [14, 69 sqq, 72-74, 77  
*angulifasciella*, *Nepticula* 69  
*angulifasciella* complex,  
 [Ectoedemia 17, 63, 64, 67, 69,  
 [75, 91  
*angulifasciella* group,  
 [Ectoedemia 2, 63 sqq, 90, 91  
*apicella*, *Nepticula* 35, 36, 53  
*arcuata*, *Nepticula* 73  
*arcuatella*, *Ectoedemia* 12-14,  
 [69, 71, 73-75  
*arcuatella*, *Nepticula* 73  
*arcuosella*, *Nepticula* 73  
*argentipedella*, *Ectoedemia* 79  
*argentipedella*, *Lyonetia* 78  
*argentipedella*, *Nepticula* 80  
*argyropeza*, *Ectoedemia* 12, 33,  
 [34, 35 sqq, 53, 88  
*argyropeza*, *Lyonetia* 35  
*argyropeza*, *Nepticula* 31  
*argyropeza* sensu Stainton,  
 [Nepticula 52  
*argyropezella* Herrich-Schäffer,  
 [Nepticula 31  
*argyropezella* Doubleday,  
 [Nepticula 35  
*aterrima*, *Nepticula* 71, 72  
*aterrimoides*, *Nepticula* 71, 72  
*atricolella*, *Nepticula* 71  
*atricollis*, *Ectoedemia* 12-14, 69,  
 [71 sqq, 75, 76  
*atricollis*, *Nepticula* 71  
*atrifrontella*, *Ectoedemia* 10, 13,  
 [15, 18 sqq, 21, 22, 24, 86  
*atrifrontella*, *Trifurcula* 18  
*bistrimaculella*, *Nepticula* 82  
*Bohemannia* 8  
*brunniella*, *Nepticula* 69, 70  
*canutus*, *Ectoedemia* 28  
*caradjai*, *Ectoedemia* 7, 11, 15,  
 [16, 38 sqq, 40, 46, 58  
*caradjai*, *Nepticula* 38  
*castanaeae*, *Ectoedemia* 18  
*castanaeae* group, *Ectoedemia* 17  
*catharticella*, *Stigmella* 48  
*ceris*, *Ectoedemia* 16, 52, 54, 55  
*ceris*, *Nepticula* 54  
*chasanella*, *Ectoedemia* 38  
*\*contorta*, *Ectoedemia* 1, 16,  
 [51-53, 55, 56, 91, 92



- cursoriella, Nepticula 57, 58  
 Dechthiria 2, 27  
 Ectoedemia 1 sqq, 27 sqq,  
     [87 sqq  
 erythrogenella, Ectoedemia 12,  
     [15, 16, 52, 64, 65, 87, 90-92  
 erythrogenella, Nepticula 64  
 Etainia 6, 8, 86  
 euphorbiella, Nepticula 39  
 Fomoria 1, 6, 8, 10, 29, 86  
 gilvella, Nepticula 82  
 gilvipennella, Ectoedemia 8, 10,  
     [15, 16, 43, 45, 46, 55, 62, 88, 90  
 gilvipennella, Stigmella 45  
 groschkei, Nepticula 39  
 hannoverella, Ectoedemia 11,  
     [14, 17, 30-33  
 hannoverella, Nepticula 30  
 haraldi, Ectoedemia 11, 15, 16,  
     [41, 44, 47-49, 52, 91  
 haraldi, Nepticula 47  
 heringella, Ectoedemia 6, 10, 15,  
     [16, 29, 42, 44, 45, 47-50, 91, 92  
 heringella, Nepticula 49  
 heringi, Ectoedemia 53, 56, 57,  
     [59 sqq  
 heringi, Nepticula 59  
 heringiella, Zimmermannia 18  
 hexapetalae, Ectoedemia 12, 14,  
     [17, 63, 67-69, 77, 87, 91  
 hexapetalae, Nepticula 68  
 \*hispanica, Ectoedemia 1, 10, 13,  
     [21-23  
 houzeui, Nepticula 35  
 ilicella, Nepticula 47  
 ilicis, Ectoedemia 10, 15, 16, 29,  
     [44, 45, 47-50, 91, 92  
 ilicis, Nepticula 48  
 intimella, Ectoedemia 5, 10, 14,  
     [16, 28 sqq, 43, 48, 88, 90  
 intimella, Nepticula 28  
 juncta, Stigmella 64  
 klimeschi, Ectoedemia 7, 12, 14,  
     [17, 32, 33 sqq, 36, 88  
 klimeschi, Nepticula 33  
 ladaniphila, Parafomoria 49  
 Laqueus 1, 8, 86  
 \*leucothorax, Ectoedemia 1, 11,  
     [15, 16, 38, 43, 46, 47, 90, 91  
 liebwerdella, Ectoedemia 5, 10,  
     [13, 15, 17, 18, 20, 21, 24, 86  
 liechtensteini, Ectoedemia  
     [55-57, 59, 61, 62  
 liechtensteini, Nepticula 61  
 liguricella, Ectoedemia 10, 13,  
     [15, 25 sqq, 86  
 lindquisti, Ectoedemia 78, 79  
 longicaudella, Ectoedemia 10,  
     [13, 15, 18-23, 86, 87  
 mahalebella, Ectoedemia 12, 15,  
     [17, 63, 67-69, 71, 75, 77, 78, 91  
 mahalebella, Nepticula 77  
 malivora, Nepticula 71, 72  
 marionella, Stigmella 31  
 mediofasciella, Ectoedemia 80,  
     [81  
 mediofasciella, Tinea 78  
 minimella, Acalyptris 8  
 minimella, Ectoedemia 11, 14,  
     [17, 78-80 sqq  
 minimella, Elachista 80  
 minorella, Nepticula 69, 70  
 \*monemvasiae, Ectoedemia 1, 7,  
     [10, 13, 15, 21, 23, 24, 87  
 montissanti, Nepticula 54, 55  
 morosella, Nepticula 35  
 mucidella, Tinea 78  
 Nepticula 2  
 niculescui, Stigmella 33, 35  
 Niepeltia 8  
 nigrocieliella, Microsetia 57, 58  
 nigrosarsella, Ectoedemia 8,  
     [10, 14, 16, 50-52, 90, 91<sup>1</sup>  
 nigrosarsella, Nepticula 51  
 \*nuristanica, Ectoedemia 1, 13,  
     [15, 25, 87  
 occultella, Ectoedemia 11, 14,  
     [17, 78 sqq  
 occultella, Phalaena 78  
 occultella group, Ectoedemia  
     [27, 78 sqq, 91  
 Parafomoria 8  
 peiuii, Stigmella 21, 22  
 Phyllocnistis 88  
 phyllotomella, Ectoedemia 56,  
     [59, 62  
 phyllotomella, Stigmella 62  
 populella, Ectoedemia 27, 28  
 populella group, Ectoedemia  
     [28 sqq, 43, 87, 88  
 populi-albae, Nepticula 31, 33  
 preisseckeri, Ectoedemia 11, 14,  
     [16, 37, 38, 47, 52, 87, 88, 90  
 preisseckeri, Nepticula 37  
 preisseckeri group, Ectoedemia  
     [37  
 prinophyllella, Nepticula 48  
 prinophyllella, Stigmella 47  
 prunivora, Nepticula 71  
 pubescivora, Ectoedemia 16,  
     [52-56, 92  
 pubescivora, Nepticula 55  
 quercifoliae, Ectoedemia 56, 57  
 quercifoliae, Nepticula 59, 60  
 quinquella, Ectoedemia 11, 15,  
     [16, 43-45, 90-92  
 quinquella, Microsetia 43  
 rubifoliella, Ectoedemia 64  
 rubivora, Ectoedemia 12, 14,  
     [71-75  
 rubivora, Nepticula 74  
 rubivora sensu Walsingham,  
     [Nepticula 64  
 sativella, Ectoedemia 56, 57, 60  
 sativella, Nepticula 59  
 schleichiella, Ectoedemia 69  
 schleichiella, Nepticula 69, 70  
 septembrella, Fomoria 48  
 simplicella, Nepticula 35, 36  
 sivickisi, Ectoedemia 18  
 species (specimen 1375),  
     [Ectoedemia 62  
 species (specimen 1843),  
     [Ectoedemia 39  
 spinosella, Ectoedemia 12, 13,  
     [15, 17, 63, 71-77, 91  
 spinosella, Nepticula 75  
 spiraeae, Ectoedemia 7, 12, 14,  
     [17, 64-71, 87-91  
 spireae, Stigmella 65, 66  
 staphyleae, Ectoedemia 69  
 staphyleae, Nepticula 71, 72  
 Stigmella 2, 29, 78, 79, 88  
 strigilella, Tinea 78  
 subapicella, Nepticula 52, 53  
 subbimaculella, Ectoedemia 39,  
     [52, 53, 56, 57 sqq, 62  
 subbimaculella, Tinea 57  
 subbimaculella complex,  
     [Ectoedemia 11, 14, 16, 56 sqq,  
     [82, 91  
 subbimaculella group,  
     [Ectoedemia 43 sqq, 87, 90, 91  
 suberis, Ectoedemia 12, 15, 16,  
     [34, 38, 40 sqq, 47, 49  
 suberis, Nepticula 40  
 suberis group, Ectoedemia  
     [38 sqq, 88, 91  
 terebinthivora, Ectoedemia 6,  
     [12, 14, 16, 27, 42, 63, 87, 90  
 terebinthivora, Trifurcula 63  
 terebinthivora group,  
     [Ectoedemia 63  
 Trifurcula 2, 8, 10, 26, 45  
 turbidella, Ectoedemia 6, 11, 14,  
     [16, 30, 31 sqq, 36, 88  
 turbidella Zeller, Nepticula 31  
 turbidella Herrich-Schäffer,  
     [Nepticula 35  
 turbulentella, Nepticula 35  
 ulmella, Ectoedemia 88

- utensis*, *Nepticula* 68-70  
*viridella*, *Nepticula* 40, 41  
*viridicola*, *Nepticula* 80  
*weaveri*, *Ectoedemia* 81  
*wilkinsoni*, *Ectoedemia* 28  
*woolhopiella*, *Ectoedemia* 79, [81  
*woolhopiella*, *Nepticula* 80  
*zimmermanni*, *Ectoedemia* 56, [57, 60  
*zimmermanni*, *Nepticula* 59  
*Zimmermannia* 1 sqq, 17 sqq, [86, 87
- PLANTAE**  
*Abies* 206  
*Aegilops* 206  
*Agrimonia eupatoria* 67  
*Agropyron* 206  
*Alnus viridis* 81  
*Archieracium* 206  
*Aremonia agrimonoides* 67  
*Artemisia* 210  
*Artemisia tridentata* 196  
*Avena* 206  
*Avena sativa* 195  
*Benzoin* 205  
*Betula* 79, 81, 82, 206, 208  
*Betula nana* 81  
*Betula pendula* 81  
*Betula pubescens* 81  
*Brachypodium* 206  
*Brassica campestris* 195  
*Brassica juncea* 195  
*Brassica napus* 195  
*Brassica nigra* 195  
*Calamagrostis* 206  
*Capparis* 208  
*Capsicum* 204  
*Carduus* 208  
*Carex* 205, 206, 208  
*Carpinus* 18  
*Castanea* 18, 22, 23, 53, 56, 57  
*Castanea sativa* 56, 60  
*Centaurea* 206  
*Cerantonia siliqua* 204  
*Chaematia* 208  
*Cirsium* 203  
*Clematis* 205  
*Corylus* 208  
*Corylus avellana* 81  
*Crataegus* 72  
*Cynodon* 206  
*Dactylus* 206  
*Ephedra* 205  
*Eruca* 204  
*Fagus* 18, 208  
*Fagus sylvatica* 20  
*Filipendula* 69  
*Filipendula hexapetala* 68  
*Filipendula vulgaris* 68, 70  
*Fragaria moschata* 73  
*Fragaria vesca* 73  
*Galium* 206  
*Haloxylon* 196, 203, 206  
*Holcus* 206  
*Humulus* 205  
*Hypericum* 204  
*Indocarex* 208  
*Inula* 206  
*Lathyrus* 203  
*Lens* 204  
*Malus sylvestris* 72  
*Medicago* 204  
*Melilotus* 204  
*Ostrya* 88  
*Phalaris* 206  
*Phleum* 206  
*Phragmites* 206  
*Pilosella* 206  
*Pistacia terebinthus* 63  
*Pisum* 204  
*Poa* 206  
*Populus* 28, 88, 208  
*Populus alba* 32, 34  
*Populus canescens* 32  
*Populus nigra* 31  
*Populus tremula* 36  
*Populus x canadensis* 31  
*Potentilla erecta* 73  
*Potentilla sterilis* 73  
*Primocarex* 208  
*Prunus avium* 72, 77  
*Prunus cerasifera* 72, 76  
*Prunus cerasus* 77  
*Prunus cocomilia* 77  
*Prunus domestica* 76  
*Prunus dulcis* 76  
*Prunus fruticosa* 76, 77  
*Prunus mahaleb* 72, 77  
*Prunus spinosa* 72, 76  
*Prunus tenella* 77  
*Pyrus communis* 72  
*Quercus* 7, 18, 26, 38, 43, 46, [88, 90, 91, 205, 206  
*Quercus alnifolia* 50, 51  
*Quercus baloot* 25  
*Quercus cerris* 46, 52, 55-58, [61, 62  
*Quercus coccifera* 18, 26, 38-40, [42, 46, 47  
*Quercus faginea* 19, 40, 60  
*Quercus frainetto* 38  
*Quercus ilex* 18, 25, 40, 47, 49, [50  
*Quercus infectoria* 38, 39  
*Quercus macrolepis* 42  
*Quercus petraea* 38, 44, [51-53, 56-58, 60, 61  
*Quercus pubescens* 19, 38, 39, [51-53, 55-58, 60, 61  
*Quercus pyrenaica* 58  
*Quercus robur* 19, 22, 44, 52, [53, 56-58, 60  
*Quercus rotundifolia* 40, 44, 47, [49  
*Quercus rubra* 58  
*Quercus suber* 23, 40, 46, 47, 49  
*Rosa sempervirens* 70  
*Rosa* 70  
*Rubus arcticus* 74  
*Rubus caesius* 74  
*Rubus chamaemorus* 74  
*Rubus fruticosus* 64, 74  
*Rubus idaeus* 74  
*Rubus saxatilis* 74  
*Rubus ulmifolius* 64  
*Salix* 88, 208  
*Salix caprea* 29  
*Salix cinerea* 29  
*Salix fragilis* 29  
*Salix pentandra* 29, 79  
*Salix phylicifolia* 29  
*Salsola* 206  
*Sanguisorba minor* 70  
*Sanguisorba officinalis* 70  
*Santolina* 206  
*Sarothamnus* 19, 206  
*Secale* 206  
*Senecio* 203  
*Serratula* 206  
*Sesamum* 204  
*Sinapis* 204  
*Solanum* 204  
*Sonchus* 203  
*Spiraea japonica* 66  
*Spiraea media* 66  
*Spiraea salicifolia* 66  
*Staphylea pinnata* 72  
*Tilia* 205 7  
*Ulmus* 24, 37, 205  
*Urginea* 204  
*Verbascum* 204  
*Vicia* 204







# TIJDSCHRIFT VOOR ENTOMOLOGIE

UITGEGEVEN DOOR

DE NEDERLANDSE ENTOMOLOGISCHE VERENIGING



NEDERLANDSE ENTOMOLOGISCHE VERENIGING

BESTUUR (BOARD)

Voorzitter (Chairman) . . . . .	C. A. W. Jeekel
Vice-voorzitter (Vice-President) . . . . .	L. H. M. Blommers
Secretaris (Secretary) . . . . .	R. de Jong
<i>Address</i> . . . . .	<i>Rijksmuseum van Natuurlijke Historie, Raamsteeg 2, Leiden 2311 PL</i>
1e Penningmeester (Treasurer I) . . . . .	L. P. S. van der Geest
<i>Address</i> . . . . .	<i>Doornenburg 9, Landsmeer 1211 GP</i>
2e Penningmeester (Treasurer II) . . . . .	A. P. J. A. Teunissen
<i>Address</i> . . . . .	<i>Strausslaan 6, Vlijmen 5251 HG</i>
Bibliothecaris (Librarian) . . . . .	W. N. Ellis
<i>Address</i> . . . . .	<i>Plantage Middenlaan 64, Amsterdam 1018 DH</i>
Lid (Member) . . . . .	B. van Aartsen

TIJDSCHRIFT VOOR ENTOMOLOGIE

Redactie (Editorial Board) . . . . .	P. J. van Helsdingen, C. van Achterberg, S. A. Ulenberg, J. van Tol, E. van Nieukerken
<i>Address</i> . . . . .	<i>Rijksmuseum van Natuurlijke Historie, Raamsteeg 2, Leiden 2311 PL</i>

The journal serves the publication of papers on Insecta, Myriapoda and Arachnoidea.  
Subscription rate: D.Fl. 300,— per year.

Issues 1—4 appeared on 10.XI.1986  
Issues 5—7 appeared on 15.XII.1986  
Issues 8 and 9 appeared on 31.VII.1987

ISSN 0040-7496



## INHOUD

Bolland, H. R. — Review of the systematics of the family Camerobiidae (Acari, Raphignathoidea). I. The genera <i>Camerobia</i> , <i>Decaphyllobius</i> , <i>Tillansobius</i> , and <i>Tycherobius</i> . . . . .	191
Davis, A. J. — Bibliography of the Ixodiphagini (Hymenoptera, Chalcidoidea, Encyrtidae), parasites of ticks (Acari, Ixodidae), with notes on their biology . . . . .	181
Hensen, R. V. — Revision of the subgenus <i>Prosceliphron</i> Van der Vecht (Hymenoptera, Sphecidae)	217
Jong, M. R. de. — Taxonomy and biogeography of Oriental Prasiini. 2. The <i>foliata</i> group of the genus <i>Lembeja</i> Distant, 1892 (Homoptera, Tibicinidae) . . . . .	141
Lieftinck, M. A. — New and little known Platycnemididae and Coenagrionidae from New Guinea and the Solomon Islands (Odonata) . . . . .	263
Oosterbroek, P., zie Theowald, Br.	
Pape, T. — A phylogenetic analysis of the Woodlouse-flies (Diptera, Rhinophoridae) . . . . .	15
Pfau, H. K. — Untersuchungen zur Konstruktion, Funktion und Evolution des Flugapparates der Libellen (Insecta, Odonata) . . . . .	35
Roskam, J. C. — Biosystematics of insects living in female birch catkins. IV. Egg-larval parasitoids of the genera <i>Platygaster</i> Latreille and <i>Metaclisis</i> Förster (Hymenoptera, Platygastridae) . . . . .	125
Theowald, Br. & P. Oosterbroek. — Zur Zoogeographie der westpalaearktischen Tipuliden. VII. Die Tipuliden der Balkanhalbinsel (Diptera, Tipulidae) . . . . .	1
Tol, J. van, zie Lieftinck, M. A.	



L  
161  
568  
Ent.

# TIJDSCHRIFT VOOR ENTOMOLOGIE

UITGEGEVEN DOOR

DE NEDERLANDSE ENTOMOLOGISCHE VERENIGING

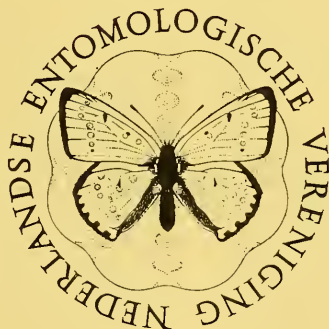

## INHOUD

BR. THEOWALD und P. OOSTERBROEK. — Zur Zoogeographie der Westpalaearktischen Tipuliden. VII. Die Tipuliden der Balkanhalbinsel (Diptera, Tipulidae), pp. 1—13.





# ZUR ZOOGEOGRAPHIE DER WESTPALAEARKTISCHEN TIPULIDEN. VII. DIE TIPULIDEN DER BALKANHALBINSEL (DIPTERA, TIPULIDAE)

von

BR. THEOWALD und P. OOSTERBROEK

Zoologisch Museum (Entomologie), Amsterdam

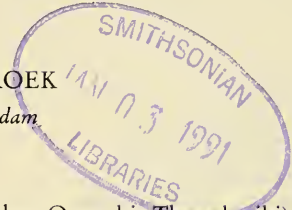

## EINLEITUNG

Unter Balkanhalbinsel (Balkan) sind in dieser Arbeit nachfolgende Staaten zusammengefaßt: Jugoslawien, Rumänien, Albanien, Bulgarien, Griechenland und die europäische Türkei. Von Teilgebieten der Balkanhalbinsel wurden schon in der zweiten Hälfte des 19. Jahrhunderts Tipuliden beschrieben und Artenlisten erstellt: Kowarz (1873), Strobl (1897, 1900, 1904), Thahammer (1900). Aber erst in der zweiten Hälfte des 20. Jahrhunderts wurde die Tipulidenfauna dieser Halbinsel eingehender studiert. Simova (ab 1959) veröffentlichte über die Tipuliden von Jugoslawien und Erhan (ab 1959) über die von Rumänien. Die Tipulidenfauna von Griechenland wurde bekannt durch Mannheims (1954) und Theischinger (ab 1977). Über Tipuliden von Albanien wurde durch Mannheims (1966), über die von Bulgarien durch Szilady (1934) berichtet. Ziemlich umfangreiches Material von vielen Fundorten auf der Balkanhalbinsel, über das bis heute noch nicht veröffentlicht wurde, findet sich in den zoologischen Museen von Amsterdam, Bonn und London.

Aufgrund von Veröffentlichungen und Sammlungen konnten wir eine Liste mit insgesamt 201 Arten zusammenstellen, die mit Sicherheit von der Balkanhalbinsel nachgewiesen sind. Diese Arten werden in Tabellen erfaßt und analysiert. In diesen Tabellen sind die größeren Balkanstaaten unterteilt (Karte 1). Für Jugoslawien wurde die Einteilung in Republiken benutzt, wie Simova sie in ihren Arbeiten verzeichnet. Rumänien wurde aufgeteilt in Südrumänien (Walachei, Südkarpaten und Banatregion), in Dobrudscha (mit Donaudelta) und in Nordrumänien (Ostkarpaten und Siebenbürgen). Griechenland ließ sich am besten einteilen in Südgriechenland (Peloponnes), Mittelgriechenland (nach dem Norden bis zum Fluß Pionion), Nordgriechenland (das griechische Ma-

zedonien nach dem Osten bis Thessaloniki) und Nordostgriechenland (von Thessaloniki nach dem Osten bis zur europäischen Türkei). Von Nordostgriechenland und von der europäischen Türkei sind insgesamt weniger als zehn Arten bekannt, weshalb diese beiden Gebiete nicht in die Tabellen aufgenommen wurden. Herr G. Theischinger war so freundlich, das Manuskript kritisch zu lesen und sprachlich zu korrigieren. Ihm sei herzlich gedankt.

## TABELLEN

Die 201 Arten der Balkanhalbinsel sind in drei Tabellen erfaßt:

1. die Arten der europäischen Tiefebene und die mit ihnen nächstverwandten Arten mit rein balkanischer Verbreitung;
2. die Arten der europäischen Gebirge und die mit ihnen nächstverwandten Arten mit rein balkanischer Verbreitung;
3. mediterrane Arten.

In der letzten Spalte jeder Tabelle sind mit Buchstaben Bemerkungen gegeben. Es bedeutet:

- A. rezent ausgewandert nach Italien, Iberien und/oder Kleinasien;
- E. endemische Art, aber mit nächstverwandter Schwesterart in Mittel- und/oder Westeuropa;
- I. rezent eingewandert aus Italien oder Iberien;
- K. rezent eingewandert aus Kleinasien;
- O. ausgewandert nur nach Osteuropa;
- Z. rezent eingewandert aus Zentralasien.

Tabelle 4 gibt eine detaillierte Zusammenfassung der Tabellen 1—3.

### Tabelle 1: Arten der europäischen Tiefebene

Nach dem Saalien haben sich viele Arten von der Balkanhalbinsel bis in die Laubwälder und Wiesen von Mittel-, West- und Osteuropa ausgebreitet. Sie wurden im Weichselien haupt-

Tabelle 1. Tipuliden-Arten der europäischen Tiefebene. (Unter Bemerkungen: E endemische Art, aber mit nächstverwandter Schwesterart in Mittel- und/oder Westeuropa; I rezent eingewandert aus Italien oder Iberien; O ausgewandert nur nach Osteuropa; Z rezent eingewandert aus Zentralasien.)

	Slowenien	Kroatien	Bosn. u. Herz.	Serbien	Montenegro	Mazedonien	Albanien	Nordgriech.	Mittelgriech.	Südgriech.	Bulgarien	Dobrudscha	Südrumänien	Nordrumänien	Bemerkungen
<i>Ctenophora</i>															
<i>elegans</i> Meigen, 1818		+						+					+	+	
<i>fastuosa</i> (Loew, 1871)		+									+		+	+	Z
<i>festiva</i> Meigen, 1804	+	+				+	+						+	+	
<i>flaveolata</i> (Fabricius, 1794)		+	+			+		+					+	+	
<i>guttata</i> Meigen, 1818		+	+	+		+		+					+	+	
<i>ornata</i> Wiedemann, 1818	+	+	+	+		+	+	+	+	+	+		+	+	
<i>pectinicornis</i> (Linnaeus, 1758)		+											+	+	
<i>Dictenidia</i>															
<i>bimaculata</i> (Linnaeus, 1758)		+	+	+		+	+	+			+	+	+	+	
<i>Nephrotoma</i>															
<i>aculeata</i> (Loew, 1871)					+	+	+	+			+		+	+	
<i>analis</i> (Schummel, 1833)						+		+			+		+	+	
<i>appendiculata</i> (Pierre, 1919)	+	+	+	+	+	+	+	+	+	+	+	+	+	+	
<i>cornicina</i> (Linnaeus, 1758)			+	+		+	+	+			+		+	+	
<i>croceiventris lindneri</i> (Mannheims, 1951)	+	+	+	+		+	+	+	+	+	+		+	+	
<i>crocata</i> (Linnaeus, 1758)	+	+	+	+		+	+						+	+	
<i>dorsalis</i> (Fabricius, 1781)	+	+	+								+		+	+	
<i>flavescens</i> (Linnaeus, 1758)	+	+	+	+	+	+					+		+		I
<i>flavipalpis</i> (Meigen, 1830)		+					+	+					+	+	I
<i>guestfalica</i> (Westhoff, 1880)						+		+		+			+	+	
<i>lunulicornis</i> (Schummel, 1833)				+		+				+			+	+	
<i>pratensis</i> (Linnaeus, 1758)		+	+	+		+							+	+	
<i>quadrifaria</i> (Meigen, 1804)	+	+	+	+		+	+	+	+				+	+	
<i>quadristriata</i> (Schummel, 1833)		+				+							+	+	
<i>scalaris</i> (Meigen, 1818)	+	+	+	+	+	+	+	+			+	+	+	+	
<i>scurra</i> (Meigen, 1818)	+				+					+			+		
<i>submaculosa</i> Edwards, 1928													+	+	I
<i>Nigrotipula</i>															
<i>nigra</i> (Linnaeus, 1758)	+		+		+						+	+	+	+	
<i>Tanyptera</i>															
<i>atrata</i> (Linnaeus, 1758)	+	+	+	+	+	+	+						+	+	
<i>nigricornis</i> (Meigen, 1818)	+		+		+										
<i>Tipula</i>															
<i>(Acutipula)</i>															
<i>fulvipennis</i> De Geer, 1776		+	+	+		+		+	+		+		+	+	
<i>luna</i> Westhoff, 1879	+	+	+	+	+	+							+	+	
<i>maxima balcanica</i> Vermoolen, 1983	+	+	+	+	+	+	+	+	+		+		+	+	E
<i>tenuicornis</i> Schummel, 1833		+	+		+								+	+	O
<i>vittata</i> Meigen, 1804			+	+		+		+	+	+					I
<i>(Beringotipula)</i>															
<i>unca</i> Wiedemann, 1817				+							+		+	+	
<i>(Dendrotipula)</i>															
<i>flavolineata</i> Meigen, 1804	+												+	+	+
<i>(Lunatipula)</i>															
<i>fascipennis</i> Meigen, 1818	+	+	+	+		+		+				+	+	+	
<i>helvola</i> Loew, 1873	+	+	+	+	+	+	+	+	+		+	+	+	+	
<i>livida</i> Van der Wulp, 1858				+	+	+	+	+	+	+		+	+		
<i>lunata</i> Linnaeus, 1758	+	+	+	+		+		+			+	+	+	+	
<i>mellea</i> Schummel, 1833		+	+									+			O



(Tabelle 1, Fortsetzung)

	Slowenien	Kroatien	Bosn. u. Herz.	Serbien	Montenegro	Mazedonien	Albanien	Nordgriech.	Mittelgriech.	Südgriech.	Bulgarien	Dobrudscha	Südrumänien	Nordrumänien	Bemerkungen
<i>pelestigma</i> Schummel, 1833		+	+	+	+	+	+		+	+		+	+	+	
<i>selene</i> Meigen, 1830		+	+												
<i>stubbisi</i> Theischinger, 1979															E
<i>vernalis</i> Meigen, 1804	+	+	+	+		+						+	+	+	
( <i>Odonatisca</i> )															
<i>nodicornis</i> Meigen, 1818	+											+	+	+	
( <i>Platytipula</i> )															
<i>luteipennis</i> Meigen, 1830		+										+	+	+	
( <i>Pterelachisus</i> )															
<i>irrorata</i> Macquart, 1826		+		+				+			+		+	+	
<i>pabulina</i> Meigen, 1818	+	+		+		+									+
<i>pseudovariipennis</i> Czizek, 1912	+	+	+	+	+	+		+	+		+	+	+	+	
<i>submarmorata</i> Schummel, 1833															+
<i>truncorum</i> Meigen, 1830	+	+		+		+					+		+	+	
<i>varipennis</i> Meigen, 1818	+	+	+	+		+							+	+	
( <i>Savtschenkia</i> )															
<i>alpium</i> Bergroth, 1888								+			+				
<i>obsoleta</i> Meigen, 1818		+	+						+				+	+	
<i>rufina</i> Meigen, 1818	+	+				+			+	+			+	+	
( <i>Schummelia</i> )															
<i>variicornis</i> Schummel, 1833				+				+	+		+		+	+	
( <i>Tipula</i> )															
<i>oleracea</i> Linnaeus, 1758	+	+	+	+		+						+	+	+	
<i>paludosa</i> Meigen, 1830	+	+	+									+	+	+	I
<i>subcunctans</i> Alexander, 1920				+	+	+							+	+	
( <i>Vestiplex</i> )															
<i>hortorum</i> Linnaeus, 1758	+	+	+	+		+							+	+	
<i>nubeculosa</i> Meigen, 1804	+	+	+	+	+	+		+			+		+	+	
<i>scripta</i> Meigen, 1830	+	+	+	+	+	+		+			+		+	+	
( <i>Yamatotipula</i> )															
<i>caesia</i> Schummel, 1833		+	+	+		+	+	+				+	+	+	
<i>couckeii</i> Tonnoir, 1921											+		+	+	
<i>decipiens</i> Czizek, 1912				+		+		+	+				+	+	O
<i>lateralis</i> Meigen, 1818	+	+	+	+	+	+	+	+	+	+	+	+	+	+	
<i>latemarginata coeruleascens</i> Lackschewitz, 1923															+
<i>marginella</i> Theowald, 1980												+	+	+	
<i>montium</i> Egger, 1863			+	+		+	+						+	+	
<i>pruinosa</i> Wiedemann, 1817			+										+	+	
<i>pierrei</i> Tonnoir, 1921				+									+	+	
<i>submontium</i> Theowald & Oosterbroek, 1981					+		+								

sächlich in das Balkanrefugium, aber auch nach Italien und Iberien zurückgedrängt. Arten, die das Weichselien in mehreren Refugien verbrachten, haben sich manchmal in heute allopatrisch vorkommende Schwestertaxa aufgeteilt. Nach dem Weichselien kamen vor allem die Arten des Balkanrefugiums wieder nach dem Norden zurück (Theowald & Oosterbroek, 1983).

Insgesamt 72 der 201 Arten der Balkanhalb-

insel (36%) gehören zu dieser Gruppe. Die meisten (61) haben sich nach dem Weichselien unverändert bis nach Mittel- und Westeuropa ausgebreitet, drei (in Tabelle 1 mit O gezeichnet) nur nach Osteuropa. Insgesamt fünf haben sich nach dem Weichselien von Iberien und/oder Italien bis auf die Balkanhalbinsel ausgebreitet (Tabelle 1 mit I) und eine (*Ctenophora fastuosa*) breitete sich von Ost- und Zentralasien nach



dem Westen aus, wo sie jetzt von der Balkanhalbinsel und von Stuttgart bekannt ist (Tabelle 1 mit Z). Eine Art (*Tipula (Acutipula) maxima*) hat sich in drei Refugien in drei Unterarten aufgespalten (Vermoolen, 1983), von denen die balkanische (*maxima balcanica*) für die Balkanhalbinsel endemisch ist (Tabelle 1 mit E). *Tipula (Lunatipula) stubbsi* ist wohl die griechische Schwesterart der europäischen *vernalis*.

Tabelle 2: Arten der europäischen Gebirge

Die meisten europäischen Gebirgsarten gehören in drei Gruppen, von denen wenigstens eine Art im Saalien auf der Balkanhalbinsel heimisch war. Nach dem Saalien haben diese Arten sich von dort über Europa verbreitet. Das Weichselien haben viele dieser Arten außerhalb der Refugien überdauert. Heute sind sie in Gebirgskomplexe zurückgedrängt, und manche haben sich in allopatrisch vorkommende Schwesertaxa aufgeteilt (Theowald & Oosterbroek, 1985).

Insgesamt 42 der 201 Arten der Balkanhalbinsel (21%) gehören zu dieser Gruppe. Die meisten (37) kommen unverändert auch in den zentral-europäischen Gebirgen vor. Nur fünf Arten (Tabelle 2 mit E) sind endemisch für die Balkanhalbinsel und haben im übrigen Europa nächstverwandte Schwesertaxa.

Bemerkung: *Tipula (Emdotipula) saginata* ist in der Tabelle mit Anführungszeichen bezeichnet. Diese Art wird von Tjeder (in Bearbeitung) in eine Reihe allopatrisch vorkommender Taxa aufgeteilt. Es ist noch unbekannt, welche dieser Taxa auf der Balkanhalbinsel heimisch sind.

Tabelle 3: Mediterrane Arten

Die mediterranen Arten kommen nur im mediterranen Gebiet vor und haben nur ausnahmsweise nächstverwandte Schwesertaxa in den Tiefebene oder Gebirgen des übrigen Europa. Die meisten dieser Arten gehören in die Untergattung *Lunatipula*, die in Tabelle 3 in Artengruppen aufgeteilt ist. Bei jeder dieser Artengruppen ist das Hauptverbreitungsgebiet bezeichnet.

Insgesamt 87 der 201 Arten der Balkanhalbinsel (43%) gehören zu dieser Gruppe. Die meisten dieser Arten (68) sind in ihrer Verbreitung auf die Balkanhalbinsel beschränkt. Einige (6) haben sich von dort weiter verbreitet (Tabelle 3 mit A): *Tipula (Lunatipula) bimaculata*, *brunneinervis* und *engeli* kommen unverändert auch in Italien und in Spanien vor (*bimaculata*

überdies in Kleinasien); *T. (L.) cretis* kommt bis Süditalien vor, *T. (L.) soosi* auch in Ungarn, in der Ukraine und im Westen von Kleinasien; *T. (Tipula) italica errans* ist auch von Kleinasien bekannt (Material von der Balkanhalbinsel wurde mit *mediterranea* und *orientalis* verwechselt, *italica errans* bewohnt jedoch ziemlich sicher die ganze Halbinsel. In Tabelle 3 ist sie aber nur verzeichnet von den Gebieten, aus denen sie uns mit Sicherheit bekannt ist). Aufgrund ihrer Verbreitung und ihrer Verwandtschaftsbeziehungen sind einige der mediterranen Arten wahrscheinlich oder sicher erst rezent eingewandert: vier aus Italien (Tabelle 3 mit I) und neun aus Kleinasien (Tabelle 3 mit K).

Tabelle 4: Zusammenfassender Überblick

In Tabelle 4 sind die Arten der Tabellen 1—3 in 12 Kategorien zusammengefaßt. Die meisten Arten (166 der 201, d.h. 83%) gehören zu einer der drei nachfolgenden Kategorien: Arten der Tiefebene, die sich bis nach Mittel- und Westeuropa verbreitet haben (61 Arten), Arten der Gebirge, die bis Mitteleuropa vorkommen (37 Arten), und mediterrane Arten, endemisch für die Balkanhalbinsel (68 Arten). Zu den neun weiteren Kategorien gehören insgesamt nur 35 Arten.

Die Tipulidenfauna der Balkanhalbinsel ist heute ziemlich gut bekannt, doch finden sich in der Verbreitung vieler Arten noch Lücken, die in Zukunft ziemlich sicher gefüllt werden können. Es besteht der Eindruck, daß Rumänien besser besammelt worden ist als das kaum größere Jugoslawien. Letztgenannter Staat ist jedoch in dieser Arbeit in sechs Teilgebiete aufgeteilt worden, Rumänien hingegen nur in drei. Im allgemeinen sind Sommerarten stärker vertreten als Frühlings- und Herbstarten, und Wald- und Wiesenarten besser als Arten der Mooregebiete.

#### ZOOGEOGRAPHISCHE BEMERKUNGEN

##### 1. Das Vorkommen balkanischer Tipuliden im westpalaearktischen Raum

###### Auswanderer (Tabelle 4A)

Die Balkanhalbinsel war im Saalien und im Weichselien das bedeutendste Refugium für die Tipuliden der europäischen Tiefebene und Gebirge (Theowald & Oosterbroek, 1983, 1985). Nachher haben viele Arten ihre Areale vor allem nach dem Nordwesten vergrößert, obwohl auch einige Arten sich nach Osteuropa ausgebreitet haben. Für insgesamt 101 Arten



Tabelle 3. Mediterrane Tipuliden — Arten. (Unter Bemerkungen: A rezent ausgewandert nach Italien, Iberien und/oder Kleinasien; I rezent eingewandert aus Italien oder Iberien; K rezent eingewandert aus Kleinasien.)

	Slowenien	Kroatien	Bosn. u. Herz.	Serbien	Montenegro	Mazedonien	Albanien	Nordgriech.	Mittelgriech.	Südgriech.	Bulgarien	Dobrudscha	Südrumänien	Nordrumänien	Bemerkungen
<i>Nephrotoma</i>															
<i>euchroma</i> (Mik, 1874)	+														I
<i>Tipula</i>															
( <i>Acutipula</i> )															
<i>ismene</i> Mannheims, 1969									+	+					
<i>schmidti</i> Mannheims, 1952							+	+	+	+					
<i>transcaucasica latifurca</i> Vermoolen, 1983							+		+		+				K
( <i>Lunatipula</i> )															
<i>clio</i> -Gruppe (Griechenland)															
<i>clio</i> Mannheims, 1954						+	+		+						
<i>euterpe</i> Theischinger, 1979									+						
<i>leda</i> Mannheims, 1965								+	+						
<i>melpomene</i> Mannheims, 1954										+					
<i>theia</i> Mannheims, 1963								+	+	+					
<i>truncata</i> -Gruppe (Griechenland)															
<i>antichasia</i> Theischinger, 1979								+	+		+				
<i>bispina</i> Loew, 1873		+		+		+	+	+	+		+				•
<i>cassiope</i> Mannheims, 1966										+					
<i>caudatula</i> Loew, 1862						+	+	+	+	+					
<i>harmonia</i> Mannheims, 1966										+					
<i>klytaimnestra</i> Theischinger, 1979									+						
<i>leto</i> Mannheims, 1966									+						
<i>penelope penelope</i> Mannheims, 1954					+					+					
<i>penelope eurykleia</i> Theischinger, 1979										+					
<i>pinnifer</i> Theischinger, 1979									+						
<i>polydeukes</i> Theischinger, 1977								+							
<i>pythia</i> Theischinger, 1979									+						
<i>seguyi</i> Mannheims, 1954		+		+		+		+	+						
<i>subtrunca</i> Mannheims, 1966										+					
<i>subtruncata</i> Mannheims, 1954					+										I
<i>titania</i> Mannheims, 1966									+						
<i>trunca</i> Mannheims, 1954									+	+					
<i>truncata truncata</i> Loew, 1873	+	+	+	+	+	+	+	+	+	+	+	+	+	+	
<i>truncata ciconia</i> Theischinger, 1979									+						
<i>tyche</i> Mannheims, 1966							+	+							
<i>fascingulata</i> -Gruppe (Balkanhalbinsel)															
<i>anicilla</i> Mannheims, 1967				+	+										
<i>animula</i> Mannheims, 1967				+		+	+								
<i>capreola</i> Mannheims, 1966					+		+		+	+					
<i>caudispina caudispina</i> Pierre, 1921							+		+	+					
<i>caudispina parnonensis</i> Theischinger, 1979										+					
<i>cinerascens</i> Loew, 1873		+	+			+									•
<i>danieli</i> Simova, 1972					+	+	+								
<i>eugeniana</i> Simova, 1972		+			+	+	+		+	+					
<i>fascicula</i> Mannheims, 1966		+													
<i>hera</i> Theischinger, 1979									+		+				
<i>lanispina</i> Mannheims, 1966							+	+	+	+					
<i>praecox</i> Loew, 1873	+	+	+	+	+	+	+	+	+						
<i>profdrassi</i> Theischinger, 1980										+					
<i>rufula</i> Mannheims & Theowald, 1959	+	+	+	+	+	+									
<i>sigma</i> Theischinger, 1979									+						
<i>thais</i> Mannheims, 1963								+	+	+					



Tabelle 4. Zusammenfassender Überblick.

	Slowenien	Kroatien	Bosn. u. Herz.	Serbien	Montenegro	Mazedonien	Albanien	Nordgriech.	Mittelgriech.	Südgriech.	Bulgarien	Dobrudscha	Südrumänien	Nordrumänien
A. ursprüngliche Fauna: 183 Arten														
1. Arten der Tiefebene: 66 Arten														
a. endemisch: 2 Arten	1	1	1	1	1	1	1	2	—	1	—	1	—	—
b. bis nach Osteuropa: 3 Arten	—	2	1	2	—	2	—	1	1	—	—	1	2	2
c. bis nach Westeuropa: 61 Arten	25	40	32	40	10	41	18	27	16	8	25	18	53	54
2. Arten der Gebirge: 42 Arten														
a. endemisch: 5 Arten	—	1	1	—	1	1	1	1	—	—	1	—	4	3
b. bis nach Zentraleuropa: 37 Arten	11	7	8	9	6	8	6	5	10	3	13	1	24	21
3. mediterrane Arten: 74 Arten														
a. endemisch: 68 Arten	6	12	14	17	9	24	15	26	43	26	4	1	5	—
b. weiter verbreitet: 6 Arten	1	2	1	3	2	3	4	5	5	3	4	2	3	1
B. rezente Einwanderer: 19 Arten														
1. Arten der Tiefebene: 6 Arten														
a. aus Iberien/Italien: 5 Arten	2	3	3	2	1	2	1	1	2	1	1	1	4	3
b. aus Zentralasien: 1 Art	—	1	—	—	—	—	—	—	—	—	1	—	1	1
2. Arten der Gebirge: keine	—	—	—	—	—	—	—	—	—	—	—	—	—	—
3. mediterrane Arten: 13 Arten														
a. aus Italien: 4 Arten	2	1	—	1	—	—	—	—	—	—	—	—	—	—
b. aus Kleinasien: 9 Arten	1	1	1	2	1	5	2	4	3	—	4	3	1	1
Total: 201 Arten	49	71	62	77	31	87	48	71	82	41	54	27	98	86

(Tabelle 4: A1 und A2) wurde eine derartige Verbreitung festgestellt. Von den mediterranen Arten sind rezent nur ganz wenige ausgewandert (Tabelle 4: A3). Nur sechs der insgesamt 75 mediterranen Arten kommen heute unverändert auch außerhalb der Balkanhalbinsel vor. Alles in allem haben sich also 107 Arten, d.h. 53% der balkanischen Tipulidenfauna, über die Balkanhalbinsel hinaus verbreitet.

#### Einwanderer (Tabelle 4B)

Es finden sich auf der Balkanhalbinsel nur verhältnismäßig wenige rezente Einwanderer, insgesamt nur 19 der 201 Arten, d.h. nur 9% der balkanischen Tipulidenfauna. Größtenteils haben sie sich entweder von Italien oder von Kleinasien bis auf die Balkanhalbinsel ausgebreitet. Die meisten sind mediterrane Arten. Es gibt aber auch einige Arten der europäischen Tiefebene, die sich von Iberien über Italien bis auf die Balkanhalbinsel verbreitet haben (Theowald & Oosterbroek, 1983).

#### Endemiten (Tabelle 4A)

Insgesamt 75 Arten, d.h. 35% der balkanischen Tipulidenfauna, sind in ihrer Verbreitung auf die Balkanhalbinsel beschränkt. Größten-

teils sind es mediterrane Arten (69), und die meisten von ihnen gehören zur Untergattung *Tipula* (*Lunatipula*) (66).

#### Die Balkanhalbinsel und das italienische Festland

Die Balkanhalbinsel und Italien haben viele Arten gemeinsam; es sind dies aber fast ausnahmslos Arten mit Verbreitung bis in die europäischen Tiefebene und kaum Arten mit Verbreitung in den Gebirgen oder in den mediterranen Gebieten (Theowald & Oosterbroek, 1983, 1984). In den beiden letzten Kaltzeiten muß es für die Arten der Tiefebene ein gemeinsames italo-balkanisches Refugium gegeben haben (Theowald & Oosterbroek, 1984). Verbreitung und Verwandtschaftsbeziehungen deuten aber daraufhin, daß nach der letzten Kaltzeit kaum noch Arten von Italien nach der Balkanhalbinsel oder umgekehrt gekommen sind.

#### Die Balkanhalbinsel und Kleinasien

Die Balkanhalbinsel hat nur wenige Arten mit dem naheliegenden artenreichen Kleinasien gemeinsam. Von den Arten der europäischen Tiefebene finden sich 16 nicht nur auf der Balkanhalbinsel sondern auch in Kleinasien, oder sie



haben dort eine nächstverwandte Schwesterart (Theowald & Oosterbroek, 1983). Von den Gebirgsarten hat nur eine in Kleinasien ein Schwesterart (Theowald & Oosterbroek, 1985). Von den mediterranen Arten haben sich rezent neun von Kleinasien bis nach der Balkanhalbinsel verbreitet (Tabelle 4B, 3b) und drei von der Balkanhalbinsel nach Kleinasien (*bimacula*, *soosi* und *italica errans*). Insgesamt kennt man von der Balkanhalbinsel und von Kleinasien zusammen etwa 300 Arten, von denen nur 29 in beiden Gebieten vorkommen. Von der Balkanhalbinsel und Italien hingegen kennen wir insgesamt etwa 250 Arten, von denen fast 100 in beiden Gebieten vorkommen.

## 2. Die Verbreitung der Tipuliden im balkanischen Raum

Aus den Tabellen 1—4 geht hervor, daß es auf der Balkanhalbinsel einen Unterschied gibt zwischen der Verbreitung der mediterranen und jener der nicht-mediterranen Arten. Letztgenannte sind ziemlich gleichmäßig über das ganze Gebiet verbreitet, die mediterranen Arten dagegen finden sich vorwiegend in der Westhälfte der Balkanhalbinsel. Eine Auszählung von Tabellen 1—3 ergibt:

Westbalkan (Jugoslawien, Albanien, Griechenland)

mediterrane Arten: 85 der insgesamt 88, d.h. 97%

nicht-mediterrane Arten: 91 der insgesamt 113, d.h. 81%

Ostbalkan (Rumänien, Bulgarien)

mediterrane Arten: 16 der insgesamt 88, d.h. 18%

nicht-mediterrane Arten: 102 der insgesamt 113, d.h. 90%

Der Westbalkan ist somit am reichsten an Ti-

puliden. Er hat nicht nur viele nicht-mediterrane Arten, die er mit dem Ostbalkan gemeinsam hat, sondern auch viele mediterrane Arten, von denen nur wenige auch im Ostbalkan vorkommen.

Es gibt aber auch Unterschiede zwischen Nord- und Südbalkan. In Tabelle 5 (vgl. auch Karte 2) wird die Balkanhalbinsel in fünf größere Gebiete unterteilt: Nordwest-, Mittelwest- und Südwestbalkan und Nordost- und Südostbalkan. Für jedes dieser Teilgebiete ist die Faunenzusammensetzung absolut und prozentuell verzeichnet. Im Westbalkan finden sich vom Norden nach dem Süden absolut und prozentuell immer mehr mediterrane und immer weniger nicht-mediterrane Arten. Im Nordwestbalkan ist jedoch noch ein Drittel der Arten mediterran und im Südwestbalkan ein Drittel der Arten nicht-mediterran. Im Ostbalkan sind prozentuell die Unterschiede zwischen beiden Gebieten viel kleiner. Beide Faunen sind vorwiegend nicht-mediterran. Die Zahl der neun mediterranen Arten im Nordostbalkan (Tabelle 5) ist aber noch flattiert, denn von diesen neun Arten, kommen vier nur im Banater Gebirge an der jugoslawisch-rumänischen Grenze vor (Tabelle 3 mit . statt +) und sind nur fünf Arten recht ostbalkanisch. Der ostbalkan, ganz besonders aber der Nordostbalkan, schließen hinsichtlich Faunenzusammensetzung eng an das mitteleuropäische Gebiet an, der Westbalkan dagegen wird nach dem Süden hin immer deutlicher mediterran.

## 3. Das balkanische Zentrum mediterraner *Lunatipula*-Arten

Die Untergattung *Lunatipula* ist in ihrer Verbreitung hauptsächlich auf die mediterranen Gebiete der Holarktis beschränkt. Im mediter-

Tabelle 5. Faunenzusammensetzung der fünf Teilgebiete der Balkanhalbinsel.

	Nordwestbalkan	Mittelwestbalkan	Südwestbalkan	Südostbalkan	Nordostbalkan
mediterrane Arten					
absolut: 87	33	46	61	12	9
prozentuell: 43%	28%	41%	66%	18%	9%
nicht-mediterrane Arten (Arten der Tiefebene)					
absolut: 72	62	53	22	40	63
prozentuell: 36%	53%	47%	23%	61%	60%
(Arten der Gebirge)					
absolut: 42	22	13	10	14	32
prozentuell: 21%	19%	12%	11%	21%	31%
Total: 201 Arten	117	112	93	66	104



Karte 1. Balkanhalbinsel mit Teilgebieten.

ranen Raum der Palaearktis finden sich 250 Arten (Theischinger & Theowald, 1981). Verhältnismäßig wenige dieser 250 Arten finden sich im iberischen und im italienischen Gebiet (Theowald & Oosterbroek, 1980, 1981, 1984). Die meisten sind auf der Balkanhalbinsel oder in Kleinasien verbreitet.

Unter den mediterranen Arten der Balkanhalbinsel sind 79 *Lunaticipula*-Arten, von denen neun rezent eingewandert sind und 70 zur ursprünglichen Fauna gehören (Tabelle 3). Letztgenannte finden sich alle im Westbalkan, einige überdies im Ostbalkan (*leandros* ist nur bekannt vom Banater Gebirge an der Grenze von Rumänien und Jugoslawien und wird zur Fauna des Westbalkan gezählt). Im Westbalkan

kommen die meisten Arten in Griechenland vor, und zum Teil reichen sie von dort mehr oder weniger weit nach Jugoslawien. Viel weniger Arten sind in ihrer Verbreitung auf Jugoslawien beschränkt oder machen den Eindruck, daß sie sich von dort mehr oder weniger weit nach Griechenland verbreitet haben (Tabelle 3).

Von den 70 zur ursprünglichen Fauna gehörigen Arten gehören 40 (57%) zu drei Artengruppen mit fast rein balkanischer Verbreitung: die *clio*-, *truncata*- und *fasciculata*-Gruppe. Insgesamt kommen von diesen drei Artengruppen nur drei Arten im kleinasiatischen Raum vor. Es ist wohl sicher, daß diese drei Artengruppen sich auf der Balkanhalbinsel differenziert haben, und daß dreimal eine Art von dort bis nach

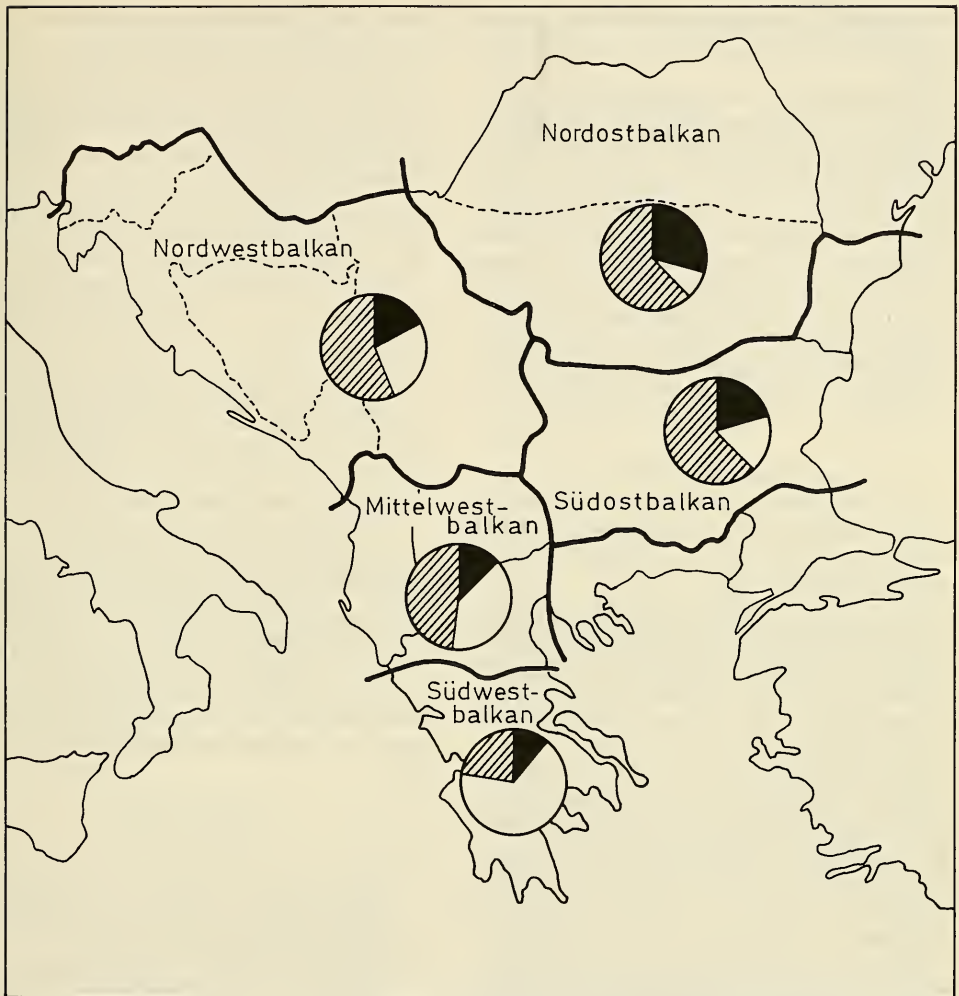

Karte 2. Hauptgebiete der Balkanhalbinsel mit Faunenzusammensetzung (schwarz: Gebirgsarten; schraffiert: Arten der Tiefebene; weiß: mediterrane Arten).

Kleinasien gelangt ist. Insgesamt 25 der 70 Arten (36%) gehören zu sechs Artengruppen mit vorwiegend kleinasiatischer Verbreitung; *acuminata*-, *macrosele*-, *livida*-, *pelio*-, *brunneinervis*-, und *lunata*-Gruppe. Im kleinasiatischen Raum gibt es von diesen Gruppen noch etwa 85 weitere Arten. Die Verwandtschaftsbeziehungen sofern bekannt, zwischen den Arten der genannten Artengruppen, lassen den Schluß zu, daß im Laufe der Zeit mehrmals Arten von Kleinasien auf die Balkanhalbinsel gekommen sind, sich dort zu endemischen Arten differenziert haben und sich zum Teil dort wieder weiter in Arten aufgespalten haben. Insgesamt nur fünf Arten gehören zu drei Arten-

gruppen mit Hauptverbreitung im westmediterranen Gebiet, auf Kreta oder im Kaukasus (Tabelle 3).

Obwohl sowohl der Westbalkan, insbesondere Griechenland, als auch Kleinasien ihre endemische *Lunatipula*-Fauna haben, hat es zwischen den beiden Gebieten dann und wann Austausch gegeben. Der kleinasiatische Einfluß auf der Balkanhalbinsel ist aber deutlich viel größer als jener der Balkanhalbinsel in Kleinasien. Dasselbe finden wir auch bei den rezent ein- und ausgewanderten Arten, die noch in beiden Gebieten unverändert vorkommen: sieben *Lunatipula*-Arten haben sich rezent von Kleinasien bis auf die Balkanhalbinsel verbreitet (Ta-



belle 3 mit K), dagegen nur zwei von der Balkanhalbinsel bis nach Kleinasien (*bimacula* und *soosi*).

Wie die Iberische Halbinsel und Nordafrika, liegen auch die Balkanhalbinsel und Kleinasien geographisch nahe zusammen, und doch hat sich in beiden Fällen in jedem dieser Gebiete eine endemische *Lunatipula*-Fauna entwickelt, obwohl es in beiden Fällen auch Auswechslung gegeben hat. Die *Lunatipula*-Fauna der beiden ostmediterranen Gebiete ist jedoch viel reicher als die der beiden westmediterranen Gebiete. Im ostmediterranen Gebiet gibt es zwei Zentren für Artbildung mediterraner *Lunatipula*-Arten: der Westbalkan, insbesondere Griechenland, und Kleinasien.

#### ZUSAMMENFASSUNG

Die Verbreitung der 201 Tipuliden-Arten, die auf der Balkanhalbinsel nachgewiesen sind, wird beschrieben und analysiert. Folgende Schlüsse werden gezogen.

Die meisten Arten der mittel- und westeuropäischen Tiefebene und Gebirge kommen auch ziemlich gleichmäßig verbreitet über die ganze Balkanhalbinsel vor; in Mittel- und Südgriechenland gibt es aber etwas weniger Arten als weiter im Norden.

In Jugoslawien und zumal in Griechenland finden sich überdies auch viele mediterrane Arten, die im Ostbalkan fast vollständig fehlen. Die Tipuliden-Fauna des Ostbalkan ist somit deutlich mittel- und westeuropäisch, die des Westbalkan dagegen hat stärker mediterranen Charakter.

Das italienische Festland und die Balkanhalbinsel haben viele Arten der europäischen Tiefebene gemeinsam, nicht aber Arten der Gebirge und mediterrane Arten. Für die Arten der europäischen Tiefebene hat es im Eiszeitalter wohl ein italo-balkanisches Refugium gegeben.

Die Balkanhalbinsel und Kleinasien haben kaum Arten gemeinsam. Zwischen beiden Gebieten hat es aber im Laufe der Zeit wohl Austausch gegeben, im Zuge dessen insbesondere *Lunatipula*-Arten sich von Kleinasien bis auf die Balkanhalbinsel verbreitet haben aber kaum umgekehrt.

Der Westbalkan und Kleinasien sind im mediterranen Gebiet der Palaearktis wohl die bedeutendsten Gebiete für Artbildung mediterraner *Lunatipula*-Arten gewesen.

#### SUMMARY

The distribution of the 201 tipulid species

from the Balkan peninsula is presented and analyzed, with the following conclusion.

Most lowland or mountain species of central and western Europe are distributed throughout the Balkan peninsula but with a lesser amount of species in central and southern Greece than further to the north.

Jugoslavia and Greece count many mediterranean species. This element is virtually lacking in the east Balkan. This part of the area is much more central and western European, whereas the west Balkan has a stronger mediterranean character.

The Italian mainland and the Balkan peninsula have many European lowland species in common. This is not the case for the mountainous and mediterranean species. An Italo-Balkan refugium is postulated for the lowland species during the latest glaciations.

The Balkan peninsula and Asia Minor hardly have species in common. Exchange during certain periods must have occurred and especially within *Lunatipula*, species of which migrated from Asia Minor to the Balkan peninsula and, to a far lesser degree, in the opposite direction.

The west Balkan and Asia Minor are of the Mediterranean part of the Palaearctic the two important regions for speciation within *Lunatipula*.

#### LITERATURLISTE

- Erhan, E., 1959. Contributii la cunoasterea faunei de tipulide (Diptera-Tipulidae) din Masivul Bucegi si cursul superior al riului Prahova. — Studii Cerc. Biol., ser. Biol. Anim. 11: 217—225.
- Erhan, E., 1962a. Date noi cu privire la fauna de tipuline (Diptera-Tipulidae) din R.P.R. — Studii Cerc. Biol., ser. Biol. Anim. 14: 91—109.
- Erhan, E., 1962b. Contributii la studiul faunei de Tipulinae (Diptera-Tipulidae) din R.P.R. — Studii Cerc. Biol., ser. Biol. Anim. 14: 351—370.
- Erhan, E., 1971. Noi specii de Tipulinae (Diptera-Tipulidae) din fauna Romaniei. — Studii Cerc. Biol., ser. Zool. 23: 537—550.
- Erhan, E., 1973. Noi contributii la cunoasterea tipulinelor (Diptera-Tipulidae) din Romania. — Studii Cerc. Biol., ser. Zool. 25: 437—445.
- Erhan, E., 1976. Contributii la studiul tipulinelor din subgenul *Lunatipula* (Diptera-Tipulidae) din Romania. — Studii Cerc. Biol., ser. Biol. Anim. 28: 13—20.
- Erhan, E., 1959. Die Entwicklungsstadien von *Tipula soosi* und *T. peliostigma*. — Tijdschr. Ent. 102: 217—221.
- Erhan, E., & Br. Theowald, 1961. Tipulidae of Roumania (Dipt., Nematocera). — Ent. Ber. Amsterdam 21: 245—252.

- Kowarz, P., 1873. Beitrag zur Dipteren-Fauna Ungarns. — Verh. zool. bot. Ges. Wien 23: 453—464.
- Mannheims, B., 1954. Die Tipuliden Griechenlands (Dipt.). — Bonn. zool. Beitr., Sonderband 1954, I: 149—182.
- Mannheims, B., 1966. Ergebnisse der Albanien-Expedition 1961 des Deutschen Entomologischen Institutes. 56. Beitr. Diptera: Tipulidae. — Beitr. Ent. 16: 489—502.
- Mannheims, B., & Br. Theowald, 1951—1980. Tipulidae. — Fliegen palaearkt. Reg. III, 5, 1. — Schweizerbart, Stuttgart.
- Savtshenko, E. N., 1961—1983. Tipulidae. — Fauna SSSR, Insecta, Diptera II, 1—2 (N.S.127, 1983), II, 3 (N.S.79, 1961), II, 4 (N.S.89, 1964), II, 5 (N.S.105, 1973). — Nauka, Moskau, Leningrad.
- Simova, D., 1959. Beitrag zur Kenntnis der Tipuliden und Limnobiiden von Mazedonien. — Fragm. Balc. 2: 125—135.
- Simova, D., 1960. Drugi prilog poznavanju tipulida i limnobiida makedonije. — Fragm. Balc. 3: 51—63.
- Simova, D., 1962. Tipulidae nekih krajeva jugoslavije. — Fragm. Balc. 4: 101—105.
- Simova, D., 1964. Neke vrste familije Tipulidae nove za jugoslaviju. — Fragm. Balc. 5: 49—54.
- Simova, D., 1972. Dve nove vrste iz familije Tipulidae (Diptera). — Zast. Bilja 23: 333—339.
- Simova, D., 1973. Contribution to the study of Crane Flies (Tipulidae, Diptera) in Yugoslavia. — Fragm. Balc. 9: 149—153.
- Simova, D., 1974. Prilog poznavanju faune Tipulidae (Diptera, Nematocera) jugoslavije. — Zast. Bilja 25: 25—30.
- Simova, D., 1976. Prilog proučavanju faune Tipulidae (Diptera) sr Srbije. — Arh. biol. nauka. Beograd 28: 147—152.
- Simova, D., 1978. *Dolichozepea graeca* Mnhs. (Diptera, Tipulidae) nov vid sa faunata na jugoslavija. — Fragm. Balc. 10: 135—138.
- Simova, D., & I. Sivec, 1978. Prispevek k poznavanju faune koseninarjev (Diptera, Tipulidae) v sloveniji. — Biol. vestn. Ljubljana 26: 183—186.
- Simova, D. & B. Todorovski, 1977. Tipulidae (Diptera) ulovljene na svetlostne klopke. — Tutun Tobacco 5—6: 249—260.
- Simova, D. & M. Vukovic, 1981. The results of Crane Flies (Diptera, Tipulidae) studies in Yugoslavia. — Acta ent. Jugoslavica 17: 13—119.
- Simova, D. & Vukovic, 1983. Usko rasprostranjene vrste faune Tipulidae (Diptera) jugoslavije. — Drugi simpozijum o fauni SR Srbije, Zbornik: 99—102. — Beograd.
- Simova, D. & Vukovic, 1983. Znacaj muskog genitalnog aparata za determinaciju vresta familije Tipulidae (Diptera). — Acta ent. Jugoslavica 19: 27—32.
- Strobl, G., 1897. Siebenbürgische Zweiflügler. — Verh. Mitt. siebenb. Ver. Naturwiss., Hermannstadt 46: 11—48.
- Strobl, G., 1900. Dipterenfauna von Bosnien, Herzegovina und Dalmatien. — Wiss. Mitt. Bosnien Herzegovina 7: 552—670.
- Strobl, G., 1904. Neue Beiträge zur Dipterenfauna der Balkanhalbinsel. — Wiss. Mitt. Bosnien Herzegovina 9: 519—581.
- Szilady, Z., 1934. Beiträge zur Dipterenfauna Bulgariens. — Izv. bulg. ent. Druzh. 8: 145—151.
- Thalhammer, J., 1900. Ordo Diptera in Fauna Regni Hungariae III, Arthropoda. Ed. sep. 1—76.
- Theischinger, G., 1977. Neue Taxa von *Lunaticipula* Edwards aus der mediterranen Subregion der Paläarktis (Diptera, Tipulidae, *Tipula* Linnaeus). — Beaufortia 26: 1—38.
- Theischinger, G., 1979a. idem, 1. Fortsetzung. — Beaufortia 28: 121—150.
- Theischinger, G., 1979b. idem, 2. Fortsetzung. — Beaufortia 29: 275—308.
- Theischinger, G., 1980. idem, 3. Fortsetzung. — Beaufortia 30: 17—29.
- Theischinger, G., 1982. idem, 4. Fortsetzung. — Beaufortia 32: 79—96.
- Theischinger, G., 1983. Über eine Aufsammlung von *Savtshenkia* Alexander, 1965, aus dem östlichen Mittelmeerraum (Diptera: Tipulidae). — Ent. Ber. Amsterdam 43: 26—28.
- Theischinger, G. & Br. Theowald, 1981. Katalog der Untergattung *Lunaticipula* Edwards, 1931, s.l. — Versl. techn. Geg. Inst. Tax. Zool. Univ. Amsterdam 27: 1—55.
- Theowald, Br., & P. Oosterbroek, 1980. Zur Zoogeographie der westpalaearktischen Tipuliden. I. Die Tipuliden von Nordafrika. — Beaufortia 30: 179—192.
- Theowald, Br., & P. Oosterbroek, 1981. idem, II. Die Tipuliden der Iberischen Halbinsel. — Beaufortia 31: 31—50.
- Theowald, Br. & P. Oosterbroek, 1983. idem, III. Die Tipuliden der europäischen Tiefebene. — Bonn. zool. Beitr. 34: 371—394.
- Theowald, Br., C. Dufour & P. Oosterbroek, 1982. idem, IV. The Tipulidae of Corsica and Sardinia with a note on *Dolichozepea fuscipes* Bergroth. — Mitt. schweiz. ent. Ges. 55: 317—332.
- Theowald, Br., & P. Oosterbroek, 1984. idem, V. Die italienischen Tipuliden. — Fragm. Entomol., Roma 17: 245—291.
- Theowald, Br., & P. Oosterbroek, 1985. idem, VI. Die Tipuliden der montanen, alpinen und borealen Gebiete. — Bonn. zool. Beitr. 36: 185—220.















1  
68  
t.

# TIJDSCHRIFT VOOR ENTOMOLOGIE

UITGEGEVEN DOOR

DE NEDERLANDSE ENTOMOLOGISCHE VERENIGING



## INHOUD

THOMAS PAPE. — A phylogenetic analysis of the Woodlouse-flies (Diptera, Rhinophoridae), pp. 15—34, figs. 1—30.





# A PHYLOGENETIC ANALYSIS OF THE WOODLOUSE-FLIES (DIPTERA, RHINOPHORIDAE)

by

THOMAS PAPE

Zoological Museum Copenhagen, Denmark



## ABSTRACT

The Rhinophoridae are redefined on the basis of the apomorphic structure of the aedeagus. Evidence is provided for the exclusion of four genera, viz., *Angioneura* Brauer & Bergenstamm, 1893, *Melanomya* Rondani, 1856, *Morinia* Robineau-Desvoidy, 1830, and *Termitoloemus* Baranov, 1936; all four are transferred to the Calliphoridae. The genera of Rhinophoridae are analyzed phylogenetically with the aid of the results of the present investigation and the sparse information available on the morphology of the larval stages. The structure of the aedeagus provides several set-defining characters and the aedeagus of many species is depicted for the first time. *Cirillia* Rondani, 1856, is proposed as a synonym of *Phyto* Robineau-Desvoidy, 1830.

## INTRODUCTION

Within the calyptrate flies the species with a row of bristles on the meron (hypopleuron) constitute a well-corroborated monophyletic group, the Tachinoidea (Tachinidae sensu Girschner (1893), Calliphoroidea sensu Hennig (1958), Tachinidae (sensu lato) sensu Griffiths (1972), or Oestroidea sensu McAlpine et al. (1981)). Most recent authors, including the present, accept five major groups in the Tachinoidea, viz., Oestridae (sensu lato), Calliphoridae, Sarcophagidae, Tachinidae, and Rhinophoridae. Although Crosskey (1965) restricts the name Tachinoidea to the Calliphoridae, Sarcophagidae, Tachinidae, and Rhinophoridae, synapomorphies not shared by the Oestridae (which would be their sister group), to my knowledge have not been provided for these four families by any author.

The family Stackelbergomyiidae Rohdendorf, 1948, was obviously established because no evidence for incorporating the single aberrant species into any of the existing families could be found. An investigation by Herting (1981) suggests that it should be included in the Tachinoidea. More interesting are the Neotropical Mesembrinellinae (Calliphoridae). Crosskey (1965) is of the opinion that an improved classification of the Tachinoidea (in his definition as given above) would result if "peculiar groups such as Mesembrinellinae were treated as families" (p. 43). Guimarães (1977) follows this recommendation and raises the group to family status: Mesembrinellidae, founding his decision on five

"consistent differences" between Mesembrinellinae and the remaining Calliphoridae. These differences corroborate the monophyly of the Mesembrinellinae, but the Calliphoridae sensu Guimarães are characterized solely on symplesiomorphies and fail to support a family status of the Mesembrinellinae. An argument for splitting up the Calliphoridae would be that the simple, non-opercular lappet of the mesembrinelline metathoracic spiracle is plesiomorphic, as this would separate the Mesembrinellinae (still monophyletic) not from the Calliphoridae but from all other Tachinoidea, the monophyly of which would be corroborated by their opercular metathoracic spiracle. This may be the reason for Crosskey's (1965: 43) note that the Mesembrinellinae "may not be Tachinoidea at all".

I hesitate to place the Mesembrinellinae as sister group to all other Tachinoidea and prefer to treat them as Calliphoridae. The structure of the mesembrinelline aedeagus with strong, forwardly curved dorsolateral processes (paraphalli) seems a reasonable synapomorphy with the Calliphoridae (and perhaps with the Rhinophoridae?).

A small digression may be made here, brought about by the recent (and past) disagreement of family status criteria. Some authors, e.g., Steyskal (1974) and Hackman & Väisänen (1982), have mentioned the inconsistency of Griffiths' (1972) splitting of the Muscidae sensu Hennig (1958, 1965) into Muscidae and Fanniidae when he unites all tachinoid flies in a single family: Tachinidae (sensu lato).

However, although Hennig (1965) states that: "Eine der sichersten Feststellungen, vielleicht die gesichertste, die man über das phylogenetische System der Muscidae treffen kann, ist die, dass zwischen den Fanniinae auf der einen Seite und der Gesamtheit aller übrigen Muscidae... ein Schwestergruppenverhältnis besteht" (p. 9), he does not bring conclusive evidence of the monophyly of the "Muscidae sensu lato". Therefore, a separation is to be preferred. If the tachinoids are considered a monophyletic group, they are best treated in common when used for outgroup comparison, and the formal rank — whether family or superfamily — is of minor importance in a phylogenetic sense. Only the ranking of the group relative to the other Calyptratae is important as this constitutes a phylogenetic hypothesis.

The monophyly of the Tachinoidea seems fairly corroborated. Griffiths (1972) mentions the following synapomorphies with respect to the groundplan of the Calyptratae:

- (1) hypopleuron with strong bristles below metathoracic spiracle,
- (2) eighth sternum (♀) entire,
- (3) vein  $m_{1+2}$  sharply bent towards  $r_{4+5}$  apically,
- (4) anal vein not reaching wing margin,
- (5) sixth tergum (♂) shortened, less than half as long as 5th tergum,
- (6) eighth tergum vestige (♂) lost.

The loss of the "eighth tergum vestige" in males is based on a questionable interpretation of a median ventral sclerotization in the postabdomen of some Anthomyiidae and Scatophagidae (Griffiths, 1972: fig. 61); this sclerotization more likely is a secondary acquisition.

Another character which may be autapomorphic to the Tachinoidea is:

- (7) lappet of metathoracic spiracle divided, posterior lappet shaped as an operculum.

This opercular metathoracic spiracle, absent in all other calyptrates, is present in the majority of the Tachinoidea; the non-opercular metathoracic spiracle present in the Mesembrinellinae and a few other Calliphoridae, some groups of Tachinidae, Macronychiinae of the Sarcophagidae, almost all Rhinophoridae, and many Oestridae (sensu lato) may be secondarily derived.

The sister group relations of the Tachinoidea within the Calyptratae are still largely unsolved, and the characters mentioned by Griffiths are not necessarily autapomorphies for the Tachinoidea, viz., items 4 and 5 mentioned above,

which also occur among other calyptrate groups. A shortened anal vein ( $A_1$ ) is characteristic of both the Muscidae and Fanniidae. A few genera in the Tachinoidea (e.g., some Oestridae (sensu lato) and Tachinidae, *Bengalia* Robineau-Desvoidy in the Calliphoridae) possess an extended anal vein, a character which both Hennig (1958) and Griffiths (1972) consider to be secondary. It is interesting, however, that Andersen (1982) reports aerial swarming of male *Siphona* Meigen as the first example within the Tachinidae and suggests (Andersen, 1982, 1983) that an extended anal vein may be assignable to the groundplan of the Tachinidae (and then possibly to all the Tachinoidea).

The shortened abdominal tergum 6 in males is of general occurrence in the Muscidae and Anthomyiidae as well.

The Rhinophoridae are typical members of the Tachinoidea as defined above (fig. 1), but the affinities to other tachinoid families are still unclear. Many earlier authors placed the rhinophorids with the blow-flies and flesh-flies in a Calliphoridae (sensu lato), but in a phylogenetic sense this constitutes an entirely unacceptable non-group arising by the splitting off of the flies possessing a swollen subscutellum — the Tachinidae. Mesnil (1939) derived most of the subfamilies of Tachinidae from different rhinophorid stocks, thereby rendering the Rhinophoridae paraphyletic (and the Tachinidae polyphyletic), but at present most authors give the Rhinophoridae family rank, acknowledging their uniqueness and the present lack of evidence for a closer relation to any of the other tachinoid families. Kugler (1978), and especially Crosskey

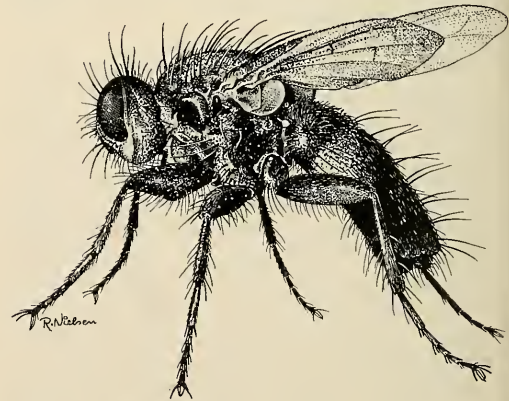

Fig. 1. *Stevenia deceptoria* (Loew); a typical woodlouse-fly.



(1977), give a more detailed review of previous differences of opinion regarding the family affinities.

#### LARVAL BIOLOGY AND MORPHOLOGY

Although the family is small, an unambiguous demarcation of the Rhinophoridae has not been possible. This is due in part to the existence of deviating tropical forms, e.g., *Bequaertiana* Curran, and in part to an external morphology intermediate between that of typical calliphorids and typical tachinids. More important, however, is the lack of information concerning the morphology and biology of the larval stages. All known first-stage larvae possess a distinctive cephalopharyngeal skeleton with the anterior part of the pharyngeal sclerite greatly elongated and with two or more teeth on the dorsal arc of the mandibles — evidently synapomorphic characters. The larval habit of parasitizing woodlice (Isopoda) is likewise unique to the Rhinophoridae, and interesting insofar as very few biological relationships between Diptera and Crustacea are known (see Roubaud, 1903; Mercier, 1921; Oldroyd, 1964, and Burger et al., 1980).

Only seven genera of rhinophorids actually have been recorded as woodlouse parasites, viz., *Stevenia* Robineau-Desvoidy, *Tricogena* Rondani, *Rhinophora* Robineau-Desvoidy, *Melanophora* Meigen, *Paykullia* Robineau-Desvoidy, *Phyto* Robineau-Desvoidy, and *Cirillia* Rondani (note that *Cirillia* is a synonym of *Phyto*, see discussion below). Specific host records for the Palaearctic species are given by Herting (1961) with supplements in Kugler (1978). Parker (1953) mentions breeding of the introduced *Melanophora roralis* (Linnaeus) in Brazil. No host records exist for any of the Nearctic, Afro-tropical, or Oriental species.

There has been some doubt as to whether the Rhinophoridae could be parasites in invertebrates other than isopods, and the tendency has been to disregard any such record. Obviously, the report of *Melanophora helicivora* Goureaux being bred from the gastropod *Helicella conspurcata* (Draparnaud) is based on a mis-identification. As judged from the description and drawings (Goureaux, 1843: figs. 1, 2), the species does not belong to *Melanophora* at all, but may be a calliphorid.

Lundbeck (1927) mentions a specimen of *Melanophora roralis* bred from egg-cocoons of the spider *Araneus cornutus* Clerck. I have seen this specimen, a female deposited in the Zoological Museum, Copenhagen, and it is correctly identified by Lundbeck.

In addition to this there are several reports of rhinophorids parasitizing insects (table 1), and it is probable that rhinophorids occasionally (accidentally?) may parasitize arthropods other than isopods.

Very little has been written on the morphology of the larvae of the woodlouse-flies. Thompson (1934) treated in detail the larval stages of eight species, viz., *Paykullia maculata* (Fallén), *Phyto angustifrons* (Rondani), *Phyto discrepans* (Pandellé), *Phyto melanocephala* (Meigen), *Melanophora roralis*, *Stevenia atramentaria* (Meigen) (as species B), *Tricogena rubricosa* (Meigen), and *Rhinophora lepida* (as species A). However, Thompson obtained all his material from dissections of woodlice as most of his attempts to obtain eggs from female flies caught in the wild and hatch these to first-instar larvae failed. Furthermore, he often assumed that rhinophorid larvae from a single colony of woodlice were conspecific. This has resulted in some erroneous identifications in his earlier works (Thompson, 1917, 1920; corrected in 1934:

Table 1. List of non-isopod hosts of the Rhinophoridae.

parasite/predator	specimens	host	reference
<i>Melanophora roralis</i>	1 ♀	eggs of <i>Araneus cornutus</i> Clerck (Araneae)	Lundbeck (1927)
	?	? <i>Pyralis farinalis</i> (Linnaeus) (Lepidoptera, Pyralidae)	Bezzi & Stein (1907)
<i>Stevenia umbratica</i>	?	<i>Callidium violaceum</i> Linnaeus (Coleoptera, Cerambycidae)	Bezzi & Stein (1907)
<i>Rhinophora lepida</i>	1 ♂	<i>Paranthrene tabaniformis</i> (Rottemburg) (Lepidoptera, Aegeriidae)	Kolubajiv (1962)
	1 ♂	<i>Saperda carcharias</i> (Linnaeus) (Coleoptera, Cerambycidae)	Kolubajiv (1962)
<i>Rhinomorinia sarcophagina</i>	1 ♂, 1 ♀	<i>Malacosoma neustria</i> (Linnaeus) (Lepidoptera, Lasiocampidae)	Kolubajiv (1962)



380). Of the first-instar larva of *Phyto angustifrons* Thompson had only a single defective specimen (the cephalopharyngeal skeleton and a skin fragment). The depicted cephalopharyngeal skeleton (Thompson, 1934: pl. 19, fig. 47) is of the heavy, sclerotized type found in *Stevenia*, *Tricogena*, and *Rhinophora* and very unlike the cephalopharyngeal skeleton of *Paykullia*, *Melanophora*, and other species of *Phyto*.

The first-stage larva assigned to *Phyto angustifrons* probably belongs to another species (very likely a *Stevenia*). The cephalopharyngeal skeleton of the second- and third-stage larva of *P. angustifrons* (Thompson, 1934: pl. 20, figs. 48, 56) is more in accordance with that of *Phyto* species.

Bedding (1973), in an extract of his Ph. D. thesis, described eggs and larval stages of all English species — actually the same species as those described by Thompson (1934) except for *P. angustifrons*. The larvae, especially first instars, possess several features which are very useful in a phylogenetic context, but at present the larval stages are known for only a small fraction of the species described. In addition, the uniqueness of many of the features makes any outgroup comparison almost inapplicable in the distinction between apomorphic versus plesiomorphic larval characters within the family.

The first-stage larvae known at present comprise two distinct groups (see figs. 8—44 in Bedding, 1973):

A. *Phyto*, *Paykullia*, *Melanophora*

- (1) mandibles with normal degree of sclerotization, with three or more small teeth on the dorsal arc,
- (2) elongated anterior part of pharyngeal sclerite with an incision,
- (3) setal bases unmodified,
- (4) posterior end of larva highly modified for supporting the larva in erect posture; with a dorsal tongue, terminal sac-like lobes, and ventral ridges.

B. *Stevenia*, *Tricogena*, *Rhinophora*

- (1) mandibles heavily sclerotized, with two strongly developed teeth,
- (2) elongated anterior part of pharyngeal sclerite without an incision,
- (3) setal bases protruded into proleg-like structures,
- (4) posterior end of larva simple, with inflated ventral vesicles.

Bedding notes that the two morphologically distinct groups of first-stage larvae possess differences in their biology (referring to a paper (in

prep.) which unfortunately has not yet been published).

The toothed mandibles of the first-stage larvae are probably an adaptation for penetrating the body wall of the host, analogous to the serrate median tooth of tachinid larvae which enter the host through a strongly sclerotized cuticle (Clausen, 1940: fig. 210 A). This character is clearly an autapomorphy for the Rhinophoridae as toothed mandibles occur very sporadically in other Tachinoidea, e.g., the warblefly of the lechwe antelope (Howard, 1980).

The two types of cephalopharyngeal skeleton can not be separated into an apomorphic and a plesiomorphic state at present; indeed, it is possible that both types are apomorphic with respect to the groundplan of the Rhinophoridae, but this may be the least parsimonious solution to the problem.

The proleg-like setal bases must be considered an apomorphic character as these are absent in the majority of the Tachinoidea and nothing indicates their suppression in other rhinophorids. This character is found in *Stevenia*, *Tricogena*, and *Rhinophora* and may be a synapomorphy of the *Stevenia* group (see discussion below), thereby corroborating the monophyly of this group.

The two types of modified posterior end of the first-stage larva present a problem somewhat analogous to that of the cephalopharyngeal skeleton. However, until more information on the sister group relations of the Rhinophoridae within the Tachinoidea becomes available, it is reasonable to assume that the sister group possesses first-stage larvae with unmodified posterior ends. The terminal lobes, the dorsal tongue, and the free, posteriorly oriented ventral ridges will then be apomorphic characters, and the terminal lobes will be the apomorphic homologues of the inflated vesicles. This will corroborate the hypothesis that *Paykullia*, *Phyto*, and *Melanophora* are part of a monophyletic group (the *Phyto* group) not containing *Stevenia*, *Tricogena*, or *Rhinophora*.

#### RECOGNITION OF THE RHINOPHORIDAE

Crosskey (1977: 7) gives an excellent discussion of the status and recognition of the family, but he admits that his recognition couplet does not ensure a certain identification. A further complication is the recently described genus *Baniassa* Kugler. This genus has a well-developed metathoracic opercular spiracle, but the absence of a distinct operculum has hitherto

provided one of the most important single characters for rhinophorid recognition. Besides the structure of the metathoracic spiracle, the characters most helpful in recognizing the family have been the tongue-shaped or oval lower calypteres which are widely removed from the scutellum, the bend of vein M which never is greatly concave, and the combination of bare prosternum, proepisterna, greater ampullae, postalar walls, laterotergites, and supra-squamal ridges.

In the majority of the Tachinoidea the structure of the aedeagus (and other structures of the terminalia) provides important characters in the diagnostic segregation of species and is often used in the construction of evolutionary trees and in the definition of taxonomic categories above the species level. Some illustrative examples are the works of Mueller (1926) on the Tachinoidea, Roback (1954) on the Sarcophaginae, Verbeke (1962) on the Tachinidae, Kurahashi (1966) on the Luciliinae, Lehrer (1970) on the Calliphoridae, and Lehrer (1973) on *Sarcophaga* (sensu stricto). The distiphallus of male rhinophorids, however, is seldom depicted, not even in the revisions of the Palaearctic (Herting, 1961) and Afrotropical (Crosskey, 1977) species, and the information stored in this structure is largely unknown. Mueller (1926) made an early attempt to construct a "Stammbaum... auf Grund der Penisform" of the Tachinoidea, but only a few rhinophorids were included and the drawings are more or less incorrect. Séguy (1941) made a preliminary division of the Rhinophoridae (as a subfamily of the Calliphoridae, sensu lato) into four groups on the basis of the male genitalia, but he dissected only a few representatives and his definition of the (sub)family included several tachinid, sarcophagid, and calliphorid genera.

The structure of the aedeagus may provide additional characters to be used in the recognition of the family; and in order to use this structure in a redefinition of the family and in the reconstruction of the phylogeny at the generic level, the following hypothetical groundplan of the tachinoid aedeagus is accepted (terminology as in Hennig, 1976 and McAlpine et al., 1981) (fig. 2).

Like most other calypterate flies a well-developed basiphallus, distiphallus and epiphallus are present. The distiphallus is more or less tubular, somewhat swollen basally, and possesses spinules on the ventral surface. The distiphallus is connected to the sclerotized basiphallus by

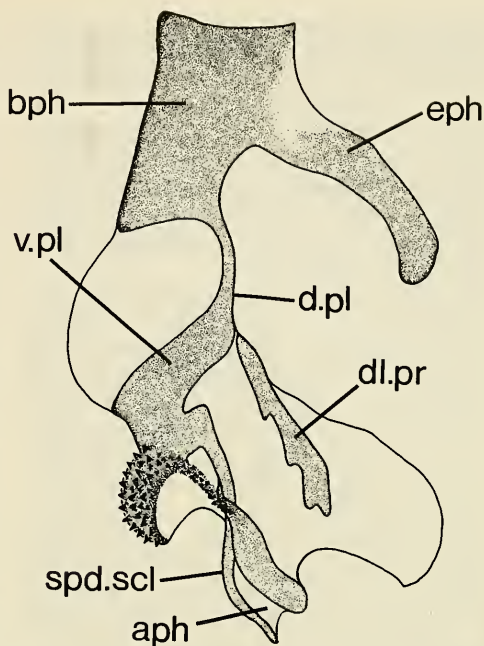

Fig. 2. *Stevenia atramentaria* (Meigen); aedeagus, lateral view. Abbreviations: aph = acrophallus, bph = basiphallus, d.pl = dorsal plate, dl.pr = dorsolateral processes, eph = epiphallus, spd.scl = spermathecal sclerotization, v.pl = ventral plate.

means of the dorsal plate, which divides distally into a pair of dorsolateral processes. The dorsal plate is extended ventrally on each side, forming two ventral plates. The acrophallus, carrying the phallotreme, is a simple, membranous extension of the distiphallus, probably encircling the three openings of the female spermathecal ducts during copulation.

The aedeagus of many rhinophorids, e.g., *Phyto* spp. (figs. 15, 16), has not diverged markedly from this ancestral state, and the view is in agreement with that of Rikhter (1980), who mentions an epiphallus, basiphallus, a distiphallus immovably connected to the basiphallus, and "relatively" simple structure of distiphallal parts as the groundplan of the Tachinidae.

Two features of the rhinophorid aedeagus deserve mention. A possible autapomorphy for the Rhinophoridae is the well-developed ventral plates clearly set off from the dorsal plate and fused along the ventral margins, thus forming a sclerotized ring. Only the genus *Paykullia* possesses unfused, but closely apposed, ventral plates, and this may be considered a reversal, as discussed below. It may seem somewhat odd to



attach any importance to this character considering the enormous variability of the distiphallus within the Tachinoidea, and certainly it is possible to enumerate several cases of non-rhinophorids (especially among the Calliphoridae) with fused ventral plates. However, most or all of these instances will be easily rejected as convergencies and I think the distinctive ventral plates will be of great value in the proper recognition of any rhinophorid.

The other character to be mentioned is the sclerotization of the ventral part of the spermduct extending from the ventral plates to the phallosome. In *Phyto* and *Parazamimus* this sclerotization is interrupted basally and does not reach the ventral plates (figs. 14—16). All other rhinophorid genera possess a sclerotization fused to the ventral plates and continuing to the phallosome.

The use of outgroup comparison for assessing the level at which this character is apomorphic is difficult to apply as the sister group of the Rhinophoridae is unknown. A similar spermduct sclerotization is of general occurrence in the Calliphoridae (the mesohypophallic sclerotization of Salzer (1968)) but absent in most Sarcophagidae and Tachinidae. If the interrupted spermduct sclerotization of *Phyto* is considered to be plesiomorphic within the Rhinophoridae then *Phyto* must be the sister group to all other genera. This hypothesis seems falsified by the several synapomorphies in the imaginal morphology of *Phyto* and *Baniassa*, and by the apomorphic larval morphology of *Phyto*, which is also found in *Paykullia* and *Melanophora*. Probably the possession of a spermduct sclerotization fused to the ventral plates is a ground-plan character in the rhinophoridae, and the spermduct sclerotization may be an important argument for a close affinity to the Calliphoridae.

To sum up, the characters which I regard as the most useful in the recognition of the family are the following:

Larval characters:

- (a) cephalopharyngeal skeleton of first-stage larvae with toothed mandibles and elongated pharyngeal sclerite,
- (b) parasites of woodlice.

Imaginal characters:

- (c) aedeagus with well-developed ventral plates that are fused (or closely apposed) along the ventral margins,
- (d) lower calypteres tongue-shaped, diverging from the scutellum,

- (e) metathoracic spiracle without a distinct operculum (except in *Baniassa*),
- (f) prosternum, proepisterna, greater ampullae, postalar walls, laterotergites, and suprasquamal ridges bare,
- (g) bend of vein M never greatly concave.

It is important to note that the characters given not necessarily are rhinophorid autapomorphies as some of them are found in other tachinoids as well. Character (f) is obviously plesiomorphic within the Tachinoidea and is provided to facilitate the exclusion of rhinophorid-like Calliphoridae.

#### GENERA MISPLACED IN THE RHINOPHORIDAE

The previous lack of an unambiguous definition of the family has resulted in some moving about of a few genera. Crosskey (1977) in his review of the Rhinophoridae gives evidence for the exclusion of genera like *Shannoniella* Townsend (Tachinidae), *Bezzimyia* Townsend (Tachinidae), and *Opsodexia* Townsend (Calliphoridae), all of which earlier have been considered to belong to the Rhinophoridae (or to the Rhinophorinae as a subfamily of the Tachinidae). This exclusion is accepted in the present paper and only the genera listed by Crosskey (1977), with the additions of Kugler (1978), will be treated in detail. Some of these clearly deviate from the definition given above and ought to be excluded from the Rhinophoridae.

#### *Angioneura* Brauer & Bergenstamm.

*Angioneura* has long been treated as belonging to the Rhinophoridae, but North American authors, especially Downes (1955, 1965), have transferred it to the Calliphoridae, this view being accepted by Wood (1979). Crosskey (1977) discusses this genus in the paragraph "included genera possibly not Rhinophoridae" but accepts its rhinophorid status. It is noteworthy that the genus *Angioneura* contains some species with enlarged lower calypteres, viz., *A. obscura* (Townsend), the only Nearctic species seen, and *A. acerba* (Meigen). The lower calypteres of the other species investigated, although distinctly diverging from the scutellum, are semicircular and not of the typical tongue-like shape characteristic of the Rhinophoridae.

The larvae, still unknown from the first stage, seem to be parasites of snails rather than woodlice. Two of the five Nearctic species of *Angioneura* are recorded as having been bred from snails (Reinhard, 1929; Downes, 1965) and *A. cyrtoneurina* (Zetterstedt) from the Palaearc-



tic Region has been bred from the snail *Succinea elegans* Risso (Čepelák & Rozkošný, 1968). Bedding (1973) collected thousands of woodlice from about 50 localities in southern England in order to breed all native species of Rhinophoridae. He did not, however, obtain any specimens of *A. acerba* or *A. cyrtoneurina*, the only English representatives (Kloet & Hincks, 1976). On this evidence I find it highly unlikely that any species of *Angioneura* parasitizes woodlice.

The presence of species with enlarged or semicircular lower calypteres, the life habit of the larvae as parasites in snails, and the ventral plates of the distiphallus which, although rather well-developed, are completely free of and widely removed from each other (fig. 3), clearly corroborate the exclusion of *Angioneura* from the Rhinophoridae, and I follow Downes (1965) in regarding *Angioneura* as a calliphorid.

It is interesting that the exclusion of *Angioneura* leaves the American continent without indigenous species of rhinophorids. Two species, however, have been established on this continent, both probably introduced from Europe: *Phyto discrepans*, which occurs in southern Canada, and *Melanophora roralis*, which is recorded from southern Canada, the eastern United States, the West Indies (Jamaica, St. Thomas), and Brazil.

Examined species: *Angioneura acerba* (Mei-

gen, 1838), *A. cyrtoneurina* (Zetterstedt, 1859), *A. fimbriata* (Meigen, 1826), *A. obscura* (Townsend, 1919).

#### *Melanomya* Rondani.

This genus is apparently closely related to *Angioneura*, and Downes (1965) treats *Angioneura* as a subgenus of *Melanomya*. No host records are known for the single European species, *Melanomya nana* (Meigen), but as with *Angioneura*, the absence of any specimens of *Melanomya nana* in the material studied by Bedding (1973) reduces the probability of a woodlouse parasitizing habit. In addition, the ventral plates of the distiphallus are rather widely separated (fig. 4).

The similarity to *Angioneura* will then indicate a position in the Calliphoridae.

The metathoracic spiracle of *M. nana* differs from the typical, somewhat triangular, rhinophorid type of spiracle (Crosskey, 1977: figs. 41—44) in being broad with a well-developed anterior fringe. This may provide further evidence for a calliphorid status as the majority of the Calliphoridae possess a rather large metathoracic spiracle, most often with a distinctly enlarged anterior lappet.

Examined species: *Melanomya nana* (Meigen, 1826).

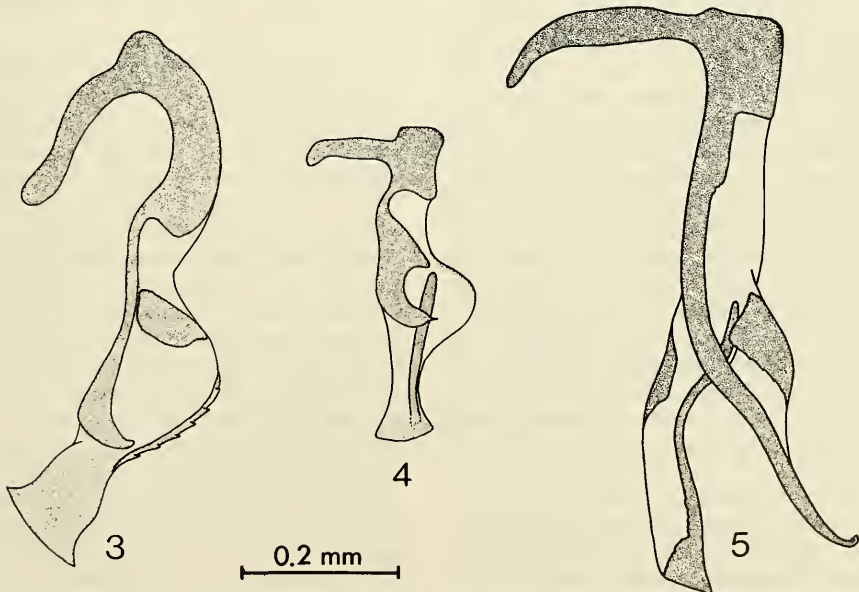

Figs. 3—5. Aedeagus of Calliphoridae, lateral view: 3, *Angioneura fimbriata* (Meigen). 4, *Melanomya nana* (Meigen). 5, *Morimia melanoptera* (Fallén).

*Morinia* Robineau-Desvoidy.

This genus is accepted as belonging to the Rhinophoridae by Crosskey (1977) in spite of the presence of distinct hairs on the postalar walls, a character used by Crosskey to exclude rhinophorid-like Calliphoridae. Haired postalar walls occur in many Calliphoridae and in the subfamily Sarcophaginae of the Sarcophagidae (very seldom in subfamily Miltogramminae), but I have not found this trait in any tachinid or rhinophorid.

The presence of haired postalar walls and the lack of well-developed ventral plates (fig. 5) make an inclusion under the Rhinophoridae somewhat improbable. Two other characters that may corroborate an exclusion are the well-developed metathoracic spiracular operculum (although an operculum is present in a single rhinophorid genus) and the presence of a weakly developed facial carina, these characters being most conspicuous in the Japanese species *M. nigerrima* (Herting). A facial carina is not found in any rhinophorid but occurs frequently in the Calliphoridae and Tachinidae. On this sparse evidence I find a position in the Calliphoridae most corroborated.

Examined species: *Morinia melanoptera* (Fallén, 1810), *M. nigerrima* (Herting, 1961).

*Termitoloemus* Baranov.

The only known species, *T. marshalli* Baranov, was originally described as belonging to the tribe Bengaliinae in the Calliphoridae. This was based on a similarity in life habits between *Bengalia* and *Termitoloemus*, predators of ants and termites, and similarities in the structure of the proboscis and palpi. Sabrosky & Crosskey (1970) transferred *Termitoloemus* to the Rhinophoridae because of the possession of a simple metathoracic spiracle and tongue-like lower calypteres. However, the lower calypteres of *Termitoloemus* differ strikingly from all rhinophorids in having a distinct notch at the posterior base (fig. 6). The lappet of the metathoracic spiracle is provided with stiff bristle-like hairs among the usual hairs. This condition is not found in the Rhinophoridae, but several groups of Calliphoridae possess stronger hairs on the anterior lappet.

I have investigated the slide-mounted genitalia of the male holotype of *T. marshalli*. The aedeagus is highly apomorphic and very unlike that of any rhinophorid (or any other tachinoid) and its ventral plates are not fused (Baranov, 1936: fig. 1). This evidence, indeed, does not

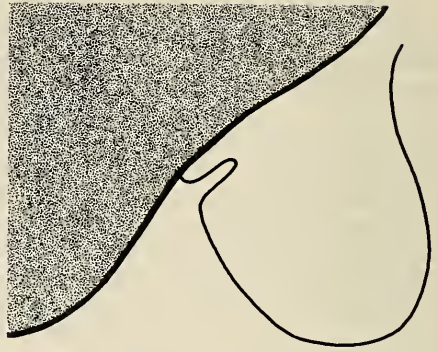

Fig. 6. *Termitoloemus marshalli* Baranov. Semidiagrammatical drawing of right lower calyptere of holotype ♂.

give much hint of the family affinity of *Termitoloemus*. The lower calypteres are not of the typical tongue-like rhinophorid type but more similar to the plesiomorphic, enlarged type, and the metathoracic spiracle can be taken as evidence for either a calliphorid or a rhinophorid status. I do not find a rhinophorid assignment the most corroborative and I have chosen to consider *Termitoloemus* to belong to the Calliphoridae.

Examined species: *Termitoloemus marshalli* Baranov, 1936.

An inventory of the genera accepted as Rhinophoridae in the present paper is given in table 2. Note that *Cirillia* is treated as a junior synonym of *Phyto*.

THE PHYLOGENY OF THE RHINOPHORID GENERA

Very few attempts to create a suprageneric classification of the Rhinophoridae have been made, and these are often of little utility owing to the inclusion of several non-rhinophorid genera.

Townsend (1935, 1938) divided his Melanophoridae (of which more than half of the genera were non-rhinophorids) into the five tribes Villeneuveiellini, Melanophorini, Acampominthoini, Eggisopsini, and Moriniini. Séguéy (1941), still with a rather broad (sub)family concept, arranged the few genera of which he had investigated the male genitalia into four groups based on perceived similarity. In the first group, *Morinia* (as *Calobataemyia*) is placed with *Nyctia* Panzer (Sarcophagidae), as Séguéy apparently has dissected a specimen of *Nyctia* erroneously taken for a *Morinia* specimen (see his fig. 445, p. 343). Two other groups, both monogeneric, contain *Stevenia* and *Melanomya* (as *Morinia*), and the last group consists of *Phyto*, *Rhinomo-*

Table 2. Inventory of genera accepted as Rhinophoridae in the present paper. Following each generic name is the number of species described at present (in brackets) and an indented list of species investigated in the present study.

<i>Acompomintbo</i> Villeneuve, 1927 (1 sp.)	<i>P. kugleri</i> (Herting, 1961)
<i>A. lobata</i> Villeneuve, 1927	<i>P. maculata</i> (Fallén, 1820)
<i>Azaisia</i> Villeneuve, 1939 (2 spp.)	<i>Phyto</i> Robineau-Desvoidy, 1830 (22 spp.)
<i>A. obscura</i> (Villeneuve, 1939)	( <i>Cirillia</i> Rondani, 1856, syn. n.)
<i>A. setitarsis</i> Villeneuve, 1939	<i>P. angustifrons</i> (Rondani, 1856) comb. n.
<i>Baniassa</i> Kugler, 1978 (2 spp.)	<i>P. cingulata</i> (Zetterstedt, 1844)
<i>B. fascipennis</i> Kugler, 1978	<i>P. discrepans</i> Pandellé, 1896
<i>B. paucipila</i> Pape, 1985	<i>P. melanocephala</i> (Meigen, 1824)
<i>Bequaertiana</i> Curran, 1929 (2 spp.)	<i>P. pauciseta</i> Herting, 1961
<i>B. argyriventris</i> Curran, 1929	<i>Queximyia</i> Crosskey, 1977 (1 sp.)
<i>B. basilewskyi</i> Peris, 1957	<i>Q. flavipes</i> Crosskey, 1977
<i>Callidesia</i> Kugler, 1978 (1 sp.)	<i>Rhinomorinia</i> Brauer & Bergenstamm, 1889 (12 spp.)
<i>C. pictipennis</i> Kugler, 1978	<i>R. capensis</i> (Brauer & Bergenstamm, 1893)
<i>Comoromyia</i> Crosskey, 1977 (1 sp.)	<i>R. sarcophagina</i> (Schiner, 1862)
( <i>C. griseithorax</i> Crosskey, 1977; not seen)	<i>R. xanthocephala</i> (Bezzi, 1908)
<i>Macrotarsina</i> Schiner, 1857 (1 sp.)	<i>Rhinophora</i> Robineau-Desvoidy, 1830 (1 sp.)
<i>M. longimana</i> (Eggers, 1856)	<i>R. lepida</i> (Meigen, 1824)
<i>Melanomyoides</i> Crosskey, 1977 (1 sp.)	<i>Stevenia</i> Robineau-Desvoidy, 1830 (18 spp.)
<i>M. melanophora</i> (Zumpt, 1959)	<i>S. angustifrons</i> Villeneuve, 1913
<i>Melanophora</i> Meigen, 1803 (2 spp.)	<i>S. atramentaria</i> (Meigen, 1824)
<i>Melanophora roralis</i> (Linnaeus, 1758)	<i>S. deceptoria</i> (Loew, 1847)
<i>Metoplixa</i> Kugler, 1978 (1 sp.)	<i>S. fernandesi</i> Baez, 1978
<i>M. carbonaria</i> Kugler, 1978	<i>S. hirtigena</i> Herting, 1961
<i>Oplisa</i> Rondani, 1862 (5 spp.)	<i>S. umbratica</i> (Fallén, 1820)
<i>O. aterrima</i> (Strobl, 1899)	<i>Tricogena</i> Rondani, 1856 (1 sp.)
<i>O. pollinosa</i> Kugler, 1978	<i>T. rubricosa</i> (Meigen, 1824)
<i>O. tergestina</i> (Schiner, 1862)	<i>Tromodesia</i> Rondani, 1856 (2 spp.)
<i>Parazamimus</i> Verbeke, 1962 (1 sp.)	<i>T. angustifrons</i> Kugler, 1978
<i>P. congolensis</i> Verbeke, 1962	<i>Ventrops</i> Crosskey, 1977 (> 1 sp.)
<i>Paykullia</i> Robineau-Desvoidy, 1830 (8 spp.)	<i>V. milichioides</i> Crosskey, 1977
<i>P. brevicornis</i> (Zetterstedt, 1844)	<i>V. spp.</i> undescribed, Pape (in prep.)

*rinia* (as *Metopisena*), *Angioneura*, *Rhinophora*, and *Melanophora*.

Herting (1961), in his revision of the Palaearctic species, divided the (sub)family into two tribes: Azaisiini (containing *Azaisia* and *Acompomintbo*), with long antennae and elongate second arisal segment, and the clearly paraphyletic Rhinophoriini, without these characters.

In the following is presented a phylogenetic analysis of the rhinophorid genera based on principles of phylogenetic systematics. Apomorphies (numbers refer to the cladogram, fig. 30) are only given for genera with more than one species, as autapomorphies of single species (if present) are not necessary for cladogram construction.

The species investigated are listed in table 2. As rhinophorids are sparse in museum collections, most of the species were seen in only few (1–5) specimens.

The monophyly of the Rhinophoridae, as de-

finied above, seems well corroborated by at least three synapomorphies:

- (1) cephalopharyngeal skeleton of first-stage larvae with toothed mandibles and an elongated pharyngeal sclerite,
- (2) parasites of woodlice,
- (3) distiphallus with well-developed ventral plates, which are fused along the ventral margins (secondarily free in *Paykullia*).

Two monophyletic subgroups, the *Phyto* group and the *Stevenia* group, can be erected on larval morphology, as previously discussed. The monophyly of the *Phyto* group is corroborated by the apomorphy:

- (4) eighth abdominal segment of first-stage larvae with terminal lobes, a dorsal tongue, and paired ventral ridges.

No shared apomorphic characters of the adult morphology have been found for the group, and as the first-stage larva is known for representatives of only three of the eight genera, the *Phyto* group is admittedly somewhat weakly founded.



The first split in the *Phyto* group separates *Paykullia* + (*Melanophora* + *Bequaertiana*) from the remaining genera, this group possessing the synapomorphies:

- (5) female terminalia of the reduced non-telescopic type,
- (6) wing cell  $r_{4+5}$  long petiolate.

Herting (1961) states that in the Palaearctic fauna only *Paykullia* and *Melanophora* possess shortened female terminalia (character 5), and Crosskey (1977), in his revision of the Afrotropical fauna, notes that the female terminalia of the Afrotropical species apparently is of the normal telescopic type, although he did not dissect any specimen.

Females of *Bequaertiana* are still unknown, but the assumed presence of non-telescopic terminalia seems well founded in the close affinity between *Melanophora* and *Bequaertiana*, as discussed below.

Character 6 is rather weak as the petiolate condition has arisen independently several times in the Rhinophoridae, and in *Bequaertiana* and *Melanophora asetosa* Kugler the bend of M is missing and an ancestral petiolate condition has to be assumed.

*Paykullia* is a well-defined genus with the following apomorphies:

- (7) distiphallus stout, possessing a strongly spinose pad on the ventral margin of each of the ventral plates and with the dorsal wall more or less prolonged (fig. 7),
- (8) male abdominal sternite 5 simple.

As most male calyprates possess a more or less excavated abdominal sternite 5, the simple, almost rectangular shape in *Paykullia* must be an apomorphic character.

The monophyly of *Bequaertiana* + *Melanophora* is corroborated by the synapomorphies:

- (9) parafrofrontalia with several (about 4—7) proclinate orbital setae,
- (10) male antennae with characteristic bottle-brush-like hairing (Crosskey, 1977: figs. 17 and 27).
- (11) hind coxae elongated.

The hind coxae of *Bequaertiana* males (females still unknown) are distinctly elongated; in both sexes of *Melanophora roralis* they are only slightly so. In addition, *Bequaertiana* and *Melanophora* possess very similar distiphalli (figs. 8, 9).

The family affinities of *Bequaertiana* have been much discussed, Zumpt (1956) even suggesting an acalyprate assignment. Crosskey (1977) doubts whether *Bequaertiana* is a rhino-

phorid and although he notes the resemblance of the head to that of *Melanophora roralis* he is more inclined to accept a relation to *Parazamimus*, another aberrant genus from the rainforests of Zaire. The striking agreement in the apomorphic structure of the male antennae, the head, and the hind coxae of both *Melanophora* and *Bequaertiana*, however, leaves no doubt of their close affinity. Actually a case can be made for treating them as congeners. *Melanophora asetosa*, of which only the female is known, seems to be a typical *Melanophora* (as judged from the description in Kugler (1978)) except for the absence of the bent part of vein M, which is an apomorphic character of *Bequaertiana*! In the collection of the Zoological Museum, University of Copenhagen, there is a single female *Melanophora* from Kenya, Naro Moru, likewise with the bend of vein M missing. The terminalia appear to be of the short non-telescopic type found in *Melanophora* and *Paykullia* (as seen in situ, the specimen is not dissected). On this evidence it seems most probable (with a parsimonious concept) that the reduced terminalia are a synapomorphy for the group *Paykullia* + (*Melanophora* + *Bequaertiana*).

The discovery of a female *Bequaertiana* and a male *Melanophora asetosa* may be most interesting, and if, as I think is most probable on the present evidence, the genus *Melanophora* is paraphyletic with respect to *Bequaertiana*, it will be necessary either to fit *Bequaertiana* into the generic limits of *Melanophora* or to place *M. asetosa* in the genus *Bequaertiana*.

*Melanophora asetosa* and *Bequaertiana* share the apomorphy:

- (12) bent part of vein M absent (Kugler, 1978: fig. 15; Crosskey, 1977: fig. 28).

A similar wing venation occurs in *Oplisa aterrima* but is obviously a convergence.

The genus *Bequaertiana* possesses some remarkable autapomorphies:

- (13) tibiae in males without clearly differentiated bristles,
- (14) male abdomen covered with thick silvery pollinosity,
- (15) wing vein  $R_1$  strongly haired along its length.

*Melanophora* (in the restricted sense with *M. roralis* as the only representative) is characterized by the distinctive white wing tips in females.

The sister group to *Paykullia* + (*Melanophora* + *Bequaertiana*) is somewhat ill-defined and

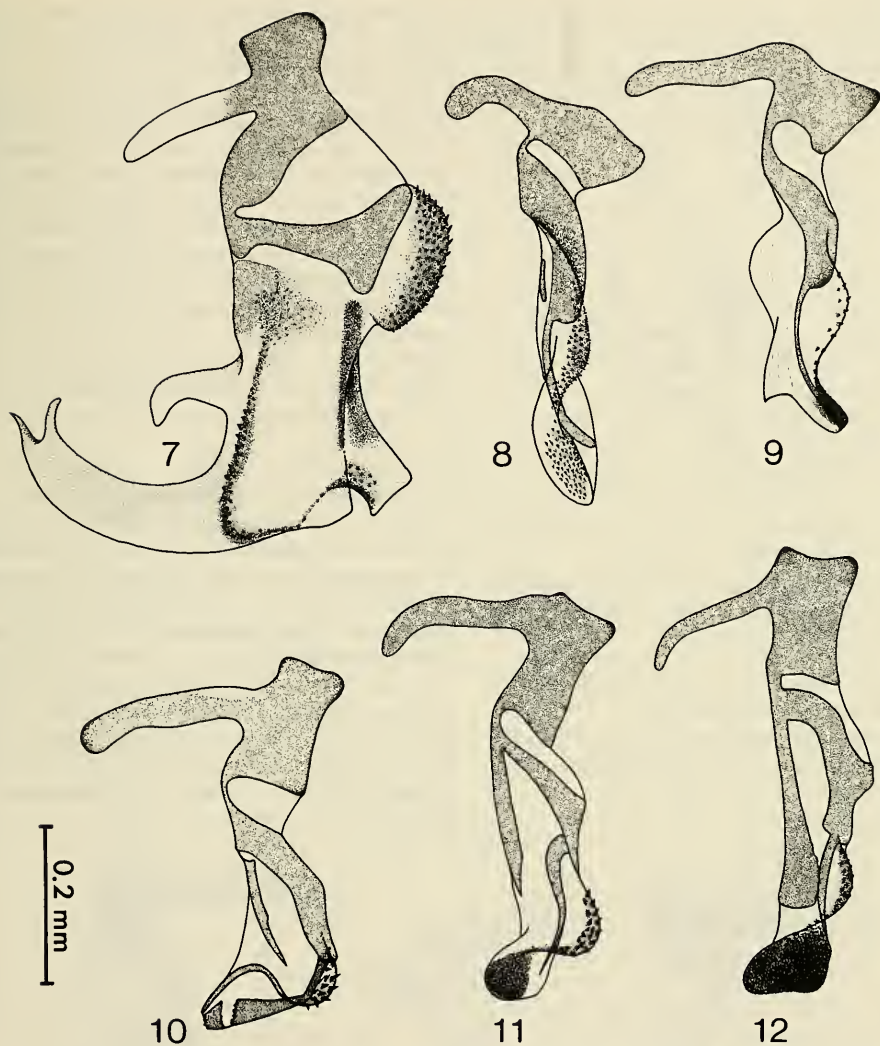

Figs. 7—12. Aedeagus of Rhinophoridae, lateral view: 7, *Paykullia maculata* (Fallén). 8, *Melanophora roralis* (Linnaeus). 9, *Bequaertiana argyriiventris* Curran. 10, *Callidesia pictipennis* Kugler. 11, *Tromodesia angustifrons* Kugler. 12, *Baniassa fascipennis* Kugler.

may be polyphyletic. The possible monophyly of the group is corroborated by the single synapomorphy:

(16) surstylar base extended medially (fig. 13).

This may seem very conclusive, but several exceptions are found. The median extension is absent in *Phyto pauciseta* and both species of *Baniassa*, and indistinct in *Phyto angustifrons*. The first split in this group separates *Tromodesia* + *Callidesia* from the remaining genera, their monophyly being corroborated by the synapomorphies:

(17) clypeus distinctly bulging,

(18) distiphallus of characteristic shape with the sclerotization of the spermduct bent dorsally (figs. 10, 11).

The two genera are depicted as sister groups on the cladogram (fig. 30), but they are very similar and could as well be treated as a single genus. I have not seen any specimen of *Tromodesia*, and therefore I have not been able to evaluate the monophyly of the genus, i.e., to investigate whether *T. vibripennis* is more

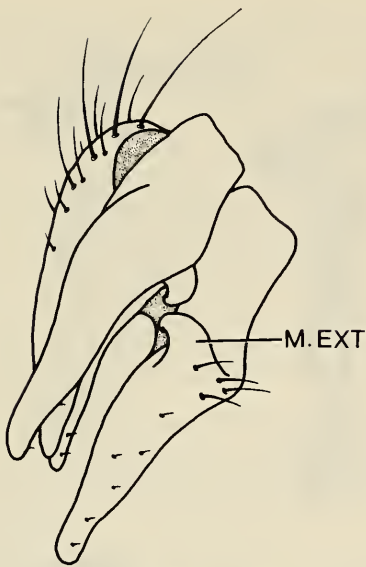

Fig. 13. *Phyto melanocephala* (Meigen). Cerci and surstyli, ventrolateral view, showing median extensions (m.ext) of surstyli.

closely related to *T. angustifrons* than to any other species (or species group).

The monophyly of the sister group of *Tromodesia* + *Callidesia* seems well corroborated by the apomorphies:

(19) lunula with setae,

(20) notopleuron haired in addition to the usual two bristles,

(21) katepimeron haired.

All these traits occur sporadically in other rhinophorids, viz., many species of *Paykullia* and *Rhinophora lepida* possess some lunular setae; *Tricogena*, some *Stevenia*, and *Rhinomorinia sarcophagina* may have a few additional notopleural hairs; and some *Rhinomorinia* may have an occasional hair on the katepimeron (barette). However, the combination of these traits seems to have arisen only once in the Rhinophoridae.

*Baniassa* is the possible sister group of *Phyto* and is well characterized by the apomorphies:

(22) strongly holoptic eyes in males,

(23) wings darkened apically,

(24) wing cell  $r_{4+5}$  petiolate,

(25) metathoracic spiracle with operculum.

As no other rhinophorids possess opercular metathoracic spiracles (character 25) this may be considered a reversal to the plesiomorphic condition. *Baniassa paucipila* Pape does not possess any of the synapomorphies 19—21 corroborating the monophyly of *Baniassa* + *Phyto*. However, the reduced hairing of *Baniassa paucipila* may be secondarily correlated with the yellow colouration of the thorax. Many yellow forms, e.g., the totally yellow species of *Parazamimus* and *Bequaertiana* from the rainforests of central Africa, possess a deviating, often re-

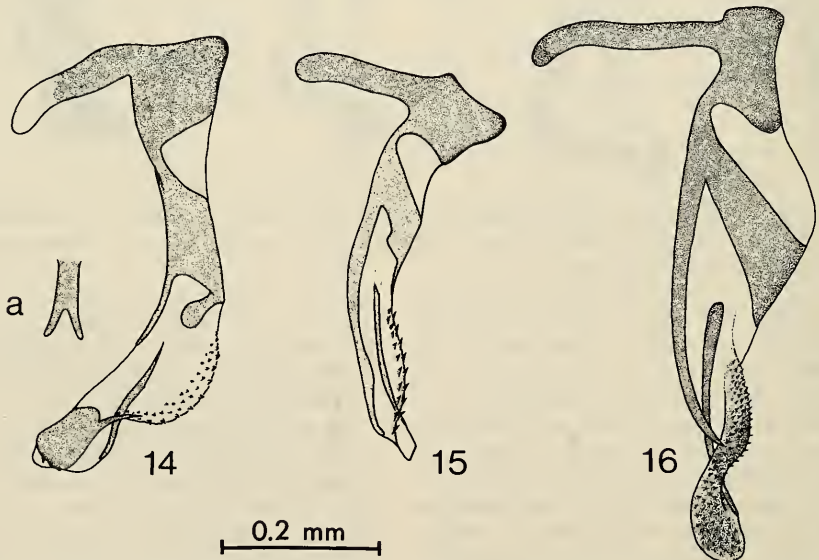

Figs. 14—16. Aedeagus of Rhinophoridae, lateral view. 14, *Parazamimus congolensis* Verbeke; a = dorsal sclerotization, dorsal view. 15, *Phyto angustifrons* (Rondani). 16, *Phyto melanocephala* (Meigen).



duced, hairing. This may be correlated with an association to a humid habitat.

The aedeagus of *B. fascipennis* is shown in fig. 12.

*Phyto* (including *Cirillia*) possesses the apomorphies:

- (26) sclerotization of the spermduct interrupted (figs. 15, 16),
- (27) strong pre-alar bristle.

*Cirillia* is characterized by the strongly developed parafacial setae and a long-petiolate wing cell  $r_{4+5}$ . These characters are likewise found in many species of *Phyto*, e.g., *P. hertingi* Baez, and as *Phyto* does not possess any derived characters not shared with *Cirillia*, a generic separation between these seems unnatural in a phylogenetic sense.

*Parazamimus* is a strange monotypic genus from the tropical rainforests of Zaire. The single specimen known is in somewhat bad condition and the micropin, by which the head is mounted on the body, unfortunately penetrates the lunula, making it impossible to see whether setae are present. The structure of the distiphallus with the reduced sclerotization of the spermduct (fig. 14) is very reminiscent of *Phyto*, and *Parazamimus* is tentatively placed as a sister group to *Phyto* although it does not possess any of the synapomorphies given for *Baniassa* + *Phyto*.

Returning to the other group that could be erected on larval morphology, the *Stevenia* group, the possible monophyly is corroborated by the apomorphies:

- (28) setal bases of first-stage larvae produced into proleg-like structures,
- (29) acrophallus sclerotized and tripartite.

Other genera like *Parazamimus* and *Tromodesia* have the acrophallus partly sclerotized, but apparently developed independently and without the tripartition which is so characteristic of the *Stevenia* group. Typically the acrophallus is divided into two lateral and one ventral sclerotization (the latter being the extension of the spermduct sclerotization), but often a dorsal acrophallic sclerite is more or less distinct. In some genera this dorsal sclerite is simple but in others it is provided with two lateral armlike processes. The three acrophallic sclerites are more or less grooved and probably guide the sperm into the ducts of the female seminal receptacles; a functional analogue to the acrophallus of many Tachinidae and Sarcophagidae (for the latter see Lopes, 1966; Lopes & Kano, 1968).

The first split in the *Stevenia* group separates

*Melanomyoides*, *Queximya*, *Rhinomorinia*, *Rhinophora*, and *Ventrops* from the remaining members of the group. All five genera have a general *Rhinomorinia*-like appearance and their monophyly is corroborated by the synapomorphy:

- (30) dorsolateral processes of distiphallus fused into a single median sclerotization (fig. 22a).

*Queximya* is a monotypic genus from South Africa, easily recognized by the very long antennae and characteristic head profile (Crosskey, 1977: fig. 14). The possession of a strong pre-alar bristle suggests an affinity with *Phyto*, but a bare katepimeron, the lack of lunular setae, and the fusion of the dorsolateral processes of the distiphallus suggest this to be unlikely. The long antennae could be taken as evidence for a close affinity to either *Azaisia* or *Acompintho*, but no other characters support this position and the present assignment based on the aedeagal structure (fig. 18) seems the best corroborative.

*Ventrops* is another well-defined Afrotropical genus, at present with only a single described species, but other species are known. The aedeagus of *V. milichioides* is shown in fig. 17. *Ventrops* possesses the following apomorphies:

- (31) eyes greatly enlarged, occupying most of the side of the head and with a concave hind margin (Crosskey, 1977: fig. 13),
- (32) cerci very short and almost concealed between the surstylar bases.

The remaining three genera, *Melanomyoides*, *Rhinomorinia*, and *Rhinophora* seem to comprise a monophyletic group corroborated by their apomorphic head structure:

- (33) epistome strongly warped forwards (Crosskey, 1977: figs. 8—10, 12)

*Melanomyoides* is a monotypic genus, its representative *M. capensis* being originally described as a species of *Chaetostevenia* Brauer (= *Paykullia*) by Zumpt (1959). Crosskey (1977) discusses the affinity of *Melanomyoides* to other (supposed) rhinophorid genera, and mentions an extreme superficial similarity to *Melanomya* and an even closer resemblance to *Angioneura*. These similarities, however, are founded in all three genera being composed of small, shining black flies with holoptic eyes in the male, characters which are not especially convincing; Crosskey concludes by stressing the resemblance in head profile and distiphallus between *Melanomyoides* and *Rhinomorinia*. Similarly, a case could be made for a sister

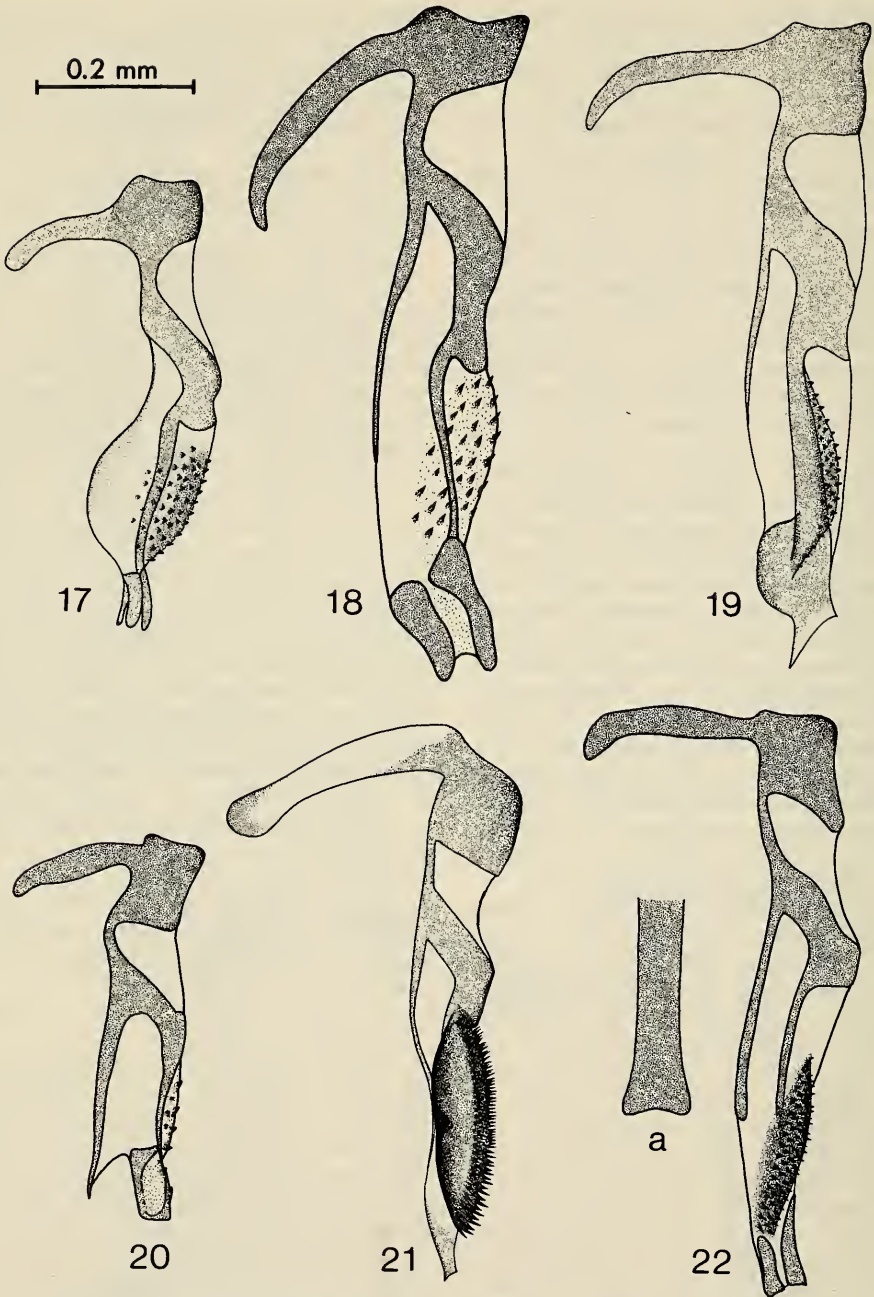

Figs. 17—22. Aedeagus of Rhinophoridae, lateral view: 17, *Ventrops milichioides* Crosskey. 18, *Queximya flavipes* Crosskey. 19, *Rhinophora lepida* (Meigen). 20, *Melanomyoides capensis* (Zumpt). 21, *Rhinomorinia xanthocephala* (Bezzi). 22, *Rhinomorinia sarcophagina* (Schiner); a = dorsal sclerotization, dorsal view.

group relation between *Melanomyoides* and *Rhinophora*, both having somewhat similar wings with a petiolate cell  $r_{4+5}$ , but a very short petiole occurs in some Afrotropical *Rhinomorinia*. *Melanomyoides* is easily distinguished by the almost leaflike surstyli, the holoptic male eyes, and the petiolate wing cell  $r_{4+5}$ . The aedeagus of *M. capensis* is shown in fig. 20.

*Rhinophora* is likewise monotypic and is easily separated from *Melanomyoides* by the dichoptic eyes in males and the presence of lunar setae. The aedeagus is shown in fig. 19.

The genus *Rhinomorinia* is difficult to characterize on external adult morphology and I have only found a single character which may establish the monophyly of the genus:

(34) Distiphallus ventrally with a greatly enlarged spinous surface (figs. 21, 22).

The long and slender cerci and surstyli (Crosskey, 1977: figs. 34, 35) may be another character, but a very similar condition is seen in *Queximya*.

The sister group to the four *Rhinomorinia*-like genera possesses the following apomorphies:

(35) acrophallus more complex, the sclerites

being longer and more distinctly grooved, (36) dorsal wall of distiphallus extended.

A dorsal extension is likewise found in *Melanomyoides* (fig. 20) but this is probably a convergence.

Two other characters which may be synapomorphies for this group are:

(37) dorsal acrophallic sclerite well-developed, with two lateral arms,

(38) hypandrium spoon-shaped.

Character 37, however, is not found in *Metopliisa*, most *Oplisa* and most *Stevenia*. Character 38 is especially distinct in *Tricogena*, *Oplisa*, *Metopliisa*, and *Azaisia*, and the flat hypandrium found in *Stevenia* must be secondarily derived.

The first split in this group separates *Acompomintho* + (*Azaisia* + *Macrotarsina*) from the others. The monophyly of these three genera is corroborated by the following synapomorphy:

(39) anal vein ( $A_1$ ) shortened.

*Acompomintho*, the only genus endemic to the Oriental Region, is well defined by the long antennae with prolonged second arisal segment, the well-developed parafacial setae (Lopes, 1938: pl. 1, fig. 2) and the long-petiolate wing cell  $r_{4+5}$ . The aedeagus is shown in fig. 25.

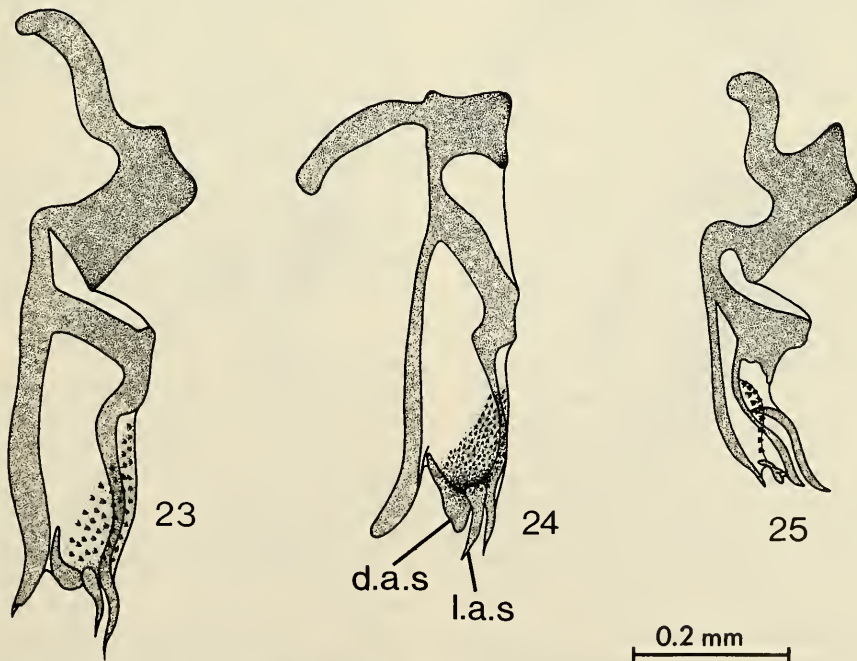

Figs. 23—25. Aedeagus of Rhinophoridae, lateral view: 23, *Macrotarsina longimana* (Eggers). 24, *Azaisia obscura* (Villeneuve). 25, *Acompomintho lobata* Villeneuve. Abbreviations: d.a.s = dorsal acrophallic sclerite; l.a.s = lateral acrophallic sclerite.



*Azaisia* + *Macrotarsina* possess the synapomorphies:

- (40) anterior katepimeral bristle much weaker than posterior one,
- (41) dorsal acrophallic sclerite well-developed, other acrophallic sclerites slender and situated close together (figs. 23, 24),
- (42) gonopods (pregonites) thickened (only slightly in *Azaisia*).

In *Acompomintho* (and all other rhinophorids) the two katepisternal (sternopleural) bristles (character 40) are subequal to equal in size.

*Macrotarsina* is well characterized by the greatly prolonged male fore tarsi. *Azaisia* is more difficult to characterize; the most conspicuous trait, which may be autapomorphic for *Azaisia*, is:

- (43) antennae long, with prolonged second aris-tal segment.

This character is likewise found in *Acompomintho* and may actually indicate a sister group relation between *Acompomintho* and *Azaisia* as accepted by Herting (1961), who established a separate tribe containing these two genera. However, I consider the sister group relation between *Azaisia* and *Macrotarsina* to be more corroborated by the present evidence.

The monophyly of the sister group of *Acompomintho* + (*Azaisia* + *Macrotarsina*) is corroborated by the apomorphy:

- (44) ventral plates of aedeagus with a pair of processes, each supporting a spinous pad (figs. 26—29).

The first split in this group separates *Metopli-sa* from *Oplisa* + (*Stevenia* + *Tricogena*). Kugler (1978), in his description of *Metopli-sa carbonaria*, mentioned the superficial similarity to *Oplisa*, but he erected the genus because the three humeral bristles of *Metopli-sa* form an obtuse-angled triangle and not an almost right-angled triangle as in *Oplisa*. The latter configuration is used as a key character for the genus *Oplisa* by Herting (1961) and Kugler (1978), but both *Stevenia* (with *S. hirtigena* as an exception) and *Tricogena* possess this character. As no other rhinophorids possess this arrangement of the humeral bristles, and as the arrangement in an obtuse-angled triangle is of widespread occurrence, the almost right-angled configuration is assumed to be a synapomorphy for *Stevenia*, *Tricogena*, and *Oplisa*:

- (45) three humeral bristles forming an almost right-angled triangle.

*Oplisa* was divided by Herting (1961) into the two subgenera *Oplisa* (as *Hoplisa*) sensu stricto,

characterized by latero-reclinate ocellar bristles, and the monotypic *Anoplisa* with proclinate ocellar bristles. Kugler (1978) described two additional species of *Oplisa*, which both would fall into the subgenus *Anoplisa*, but as this is clearly a paraphyletic group (as defined by Herting) it is not accepted in the present paper.

*Oplisa* is somewhat difficult to characterize by distinct autapomorphies. The enormously enlarged ejaculatory sclerite of *O. tergestina*, *O. aterrima*, and *O. oldenbergi* (Herting) (see Crosskey, 1977: fig. 40; Draber-Moňko, 1978: fig. 18) is unique in the Rhinophoridae, but *O. pollinosa* possesses a normal-sized ejaculatory sclerite.

The following apomorphies corroborate the monophyly of *Oplisa*:

- (46) distiphallus with the processes of the ventral plate, which support the spinous pads, situated on a stalked extension (fig. 27),
- (47) male cerci short and blunt, not separated apically,
- (48) surstyli broadened apically.

It seems fairly corroborated that a sister group relation exists between *Stevenia* and *Tricogena*, which share the apomorphy:

- (49) parafacial plate with a row of strong setae.

Both genera are very similar in external morphology and in the structure of the aedeagus (figs. 28, 29). *Stevenia* is a well-defined genus with the following apomorphies:

- (50) wing cell  $r_{4+5}$  petiolate,
- (51) hypandrium flat,
- (52) mid femur in males with a posteroventral comb of short stout bristles apically.

Some species do not, however, possess character 52 (Herting, 1961), which may define an infrageneric subgroup.

#### GENUS INCERTAE SEDIS

##### *Comoromyia* Crosskey.

Crosskey (1977) described the genus on a single female of *C. griseithorax*. I have not seen this specimen, which seems to be the only one known at present, and I have not been able to incorporate the genus into the cladogram on the basis of the description alone. Crosskey mentions a possible relationship with *Phyto*, as *Comoromyia* possesses a strong pre-alar bristle, but the bare katepimeron weakens this argument. I prefer to exclude *Comoromyia* from the cladogram (fig. 30) until more information is available, especially with regard to the structure of the aedeagus as this provides several of the set-defining characters of the present analysis.

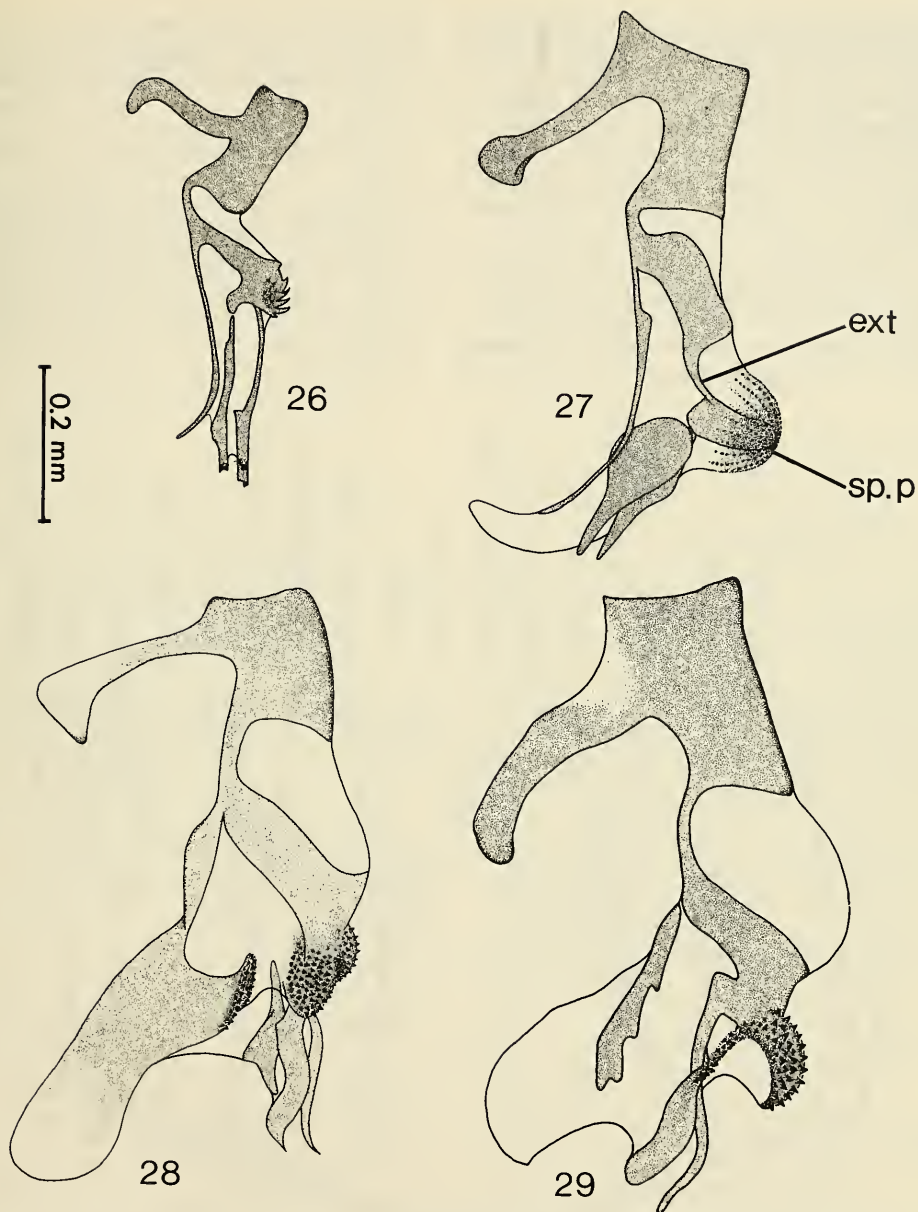

Figs. 26—29. Aedeagus of *Rhinophoridae*, lateral view: 26, *Metoplisha carbonaria* Kugler. 27, *Oplisa aterrima* (Strobl). 28, *Tricogena rubricosa* (Meigen). 29, *Stevenia atramentaria* (Meigen). Abbreviations: ext = stalked extension of ventral plate; sp.p = spinous pad.

ACKNOWLEDGEMENTS

I am grateful to the following colleagues for kindly providing me with a valuable material: Drs. M. Baez (Universidad de la Laguna, Tenerife), E. de Coninck (Musée royal de l'Afrique

Centrale, Tervuren), R. W. Crosskey (British Museum (Natural History), London), R. Danielsson (Zoologiska Institutionen, Lund), A. Freidberg (Tel Aviv University, Tel Aviv), P. Grootaert (Institut royal des Sciences Naturelle

de Belgique, Brussels), B. Herting (Staatliches Museum für Naturkunde, Stuttgart), H. J. Müller (Deutsches Entomologisches Institut, Eberswalde-Finow), K. A. Schmidt (American Museum of Natural History, New York), P. Tschorsnig (Staatliches Museum für Naturkunde, Stuttgart), and N. E. Woodley (National Museum of Natural History, Washington, D.C.).

I am indebted to Mr. R. W. Crosskey for his help during a visit at the Entomological Department of the British Museum (Natural History). Special thanks are extended to Dr. L. Lyneborg (Zoological Museum, Copenhagen) for valuable

help and advice during my study, and to Drs. V. Michelsen and S. Andersen (Zoological Museum, Copenhagen) for many stimulating discussions.

Note added while this paper was already in press:

The paper by H.-P. Tschorsnig, 1985, Die Struktur des männlichen Postabdomens der Rhinophoridae (Diptera), Stuttg. Beitr. Naturk. ser. A 375, pp. 1—18, appeared after submitting this paper for publication and a detailed discussion of the hypotheses presented will appear in a future paper.

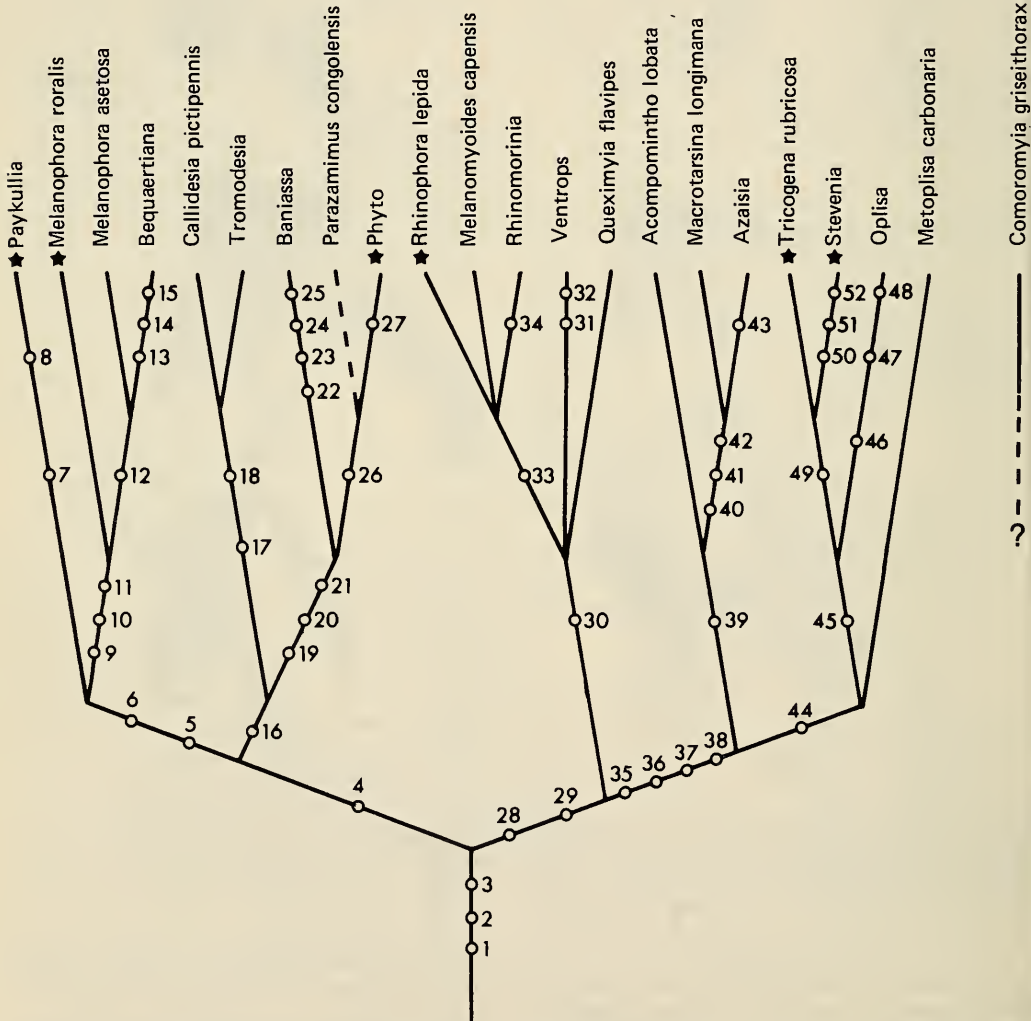

Fig. 30. Cladogram of the Rhinophoridae at the generic level. Numbers refer to apomorphies discussed in the text. Genera recorded as woodlouse parasites are marked with an asterisk.



## REFERENCES

- Andersen, S., 1982. Revision of European species of *Siphona* Meigen (Diptera: Tachinidae). — Ent. scand. 13: 149—172.
- Andersen, S., 1983. Phylogeny and classification of old world genera of Siphonini (Diptera: Tachinidae). — Ent. scand. 14: 1—15.
- Baranov, N., 1936. Eine neue Calliphorine-Art (Dipt.), die Termiten angreift. — Ann. Mag. nat. Hist. (10) 17: 646—651.
- Bedding, R. A., 1973. The immature stages of Rhinophorinae (Diptera: Calliphoridae) that parasitise British woodlice. — Trans. R. ent. Soc. Lond. 125 (1): 27—44.
- Bezzi, M. & Stein, P., 1907. Katalog der paläarktischen Dipteren. III. Cyclorhapha Aschiza. Cyclorhapha Schizophora: Schizometopa: 827 pp. — Budapest.
- Burger, J. F., Anderson, J. R. & Knudsen, M. F., 1980. The habits and life history of *Oedoparena glauca* (Diptera: Dryomyzidae), a predator of barnacles. — Proc. ent. Soc. Wash. 82(3): 360—377.
- Čepelák, J. & Rozkošný, R., 1968. Zur Bionomie der Art *Angioneura cyrtoneurina* Zetterstedt, 1859 (Rhinophorinae, Diptera). — Acta Zootechnica 17: 181—191.
- Clausen, C. P., 1940. Entomophagous insects: i—x, 1—688. — McGraw-Hill.
- Crosskey, R. W., 1965. A systematic revision of the Ameninae (Diptera: Calliphoridae). — Bull. Br. Mus. nat. Hist. B. 16: 33—140.
- Crosskey, R. W., 1977. A review of the Rhinophoridae (Diptera) and a revision of the Afrotropical species. — Bull. Br. Mus. nat. Hist. B. 36: 1—66.
- Downes, W. L., Jr., 1955. Notes on the morphology and classification of the Sarcophagidae and other calyptrates (Diptera). — Proc. Iowa Acad. Sci. 62: 514—538.
- Downes, W. L., Jr., 1965. Tribe Melanomyini. Pp. 932—933 in: Stone et al.: A catalog of the Diptera of America north of Mexico. — Agricultural Handbook 276, U.S. Department of Agriculture, Washington, D.C.
- Draber-Monko, A., 1978. Scatophagidae, Muscinae, Gasterophilidae, Hippoboscidae, Calliphoridae, Sarcophagidae, Rhinophoridae, Oestridae, Hypodermatidae und Tachinidae (Diptera) der Pieninen. — Fragm. faun. 22(2): 51—229. (In Polish, with Russian and German summaries.)
- Girschner, E., 1893. Beitrag zur Systematik des Musciden. — Berl. ent. Z. 38: 297—312.
- Goureaux, M., 1843. Sur un diptère dont la larve vit dans l'*Helix conspurcata*. — Annl. Soc. ent. Fr. 1: 77—80.
- Griffiths, G. C. D., 1972. The phylogenetic classification of Diptera Cyclorhapha with special reference to the structure of the male postabdomen: 340 pp. — Junk Publishers, The Hague.
- Guimarães, J. H., 1977. A systematic revision of the Mesembrinellidae, stat. nov. (Diptera, Cyclorhapha). — Arqs Zool. 29(1): 1—109.
- Hackman, W. & Väisänen, R., 1982. Different classification systems in the Diptera. — Annl. Zool. Fenn. 19: 209—219.
- Hennig, W., 1958. Die Familien der Diptera Schizophora und ihre phylogenetischen Verwandtschaftsbeziehungen. — Beitr. Ent. 8 (5—6): 505—688.
- Hennig, W., 1965. Vorarbeiten zu einem phylogenetischen System der Muscidae (Diptera: Cyclorhapha). — Stuttg. Beitr. Naturk. 141: 1—100.
- Hennig, W., 1976. Anthomyiidae. Pp. I—LXXVIII in Lindner: Die Fliegen der paläarktischen Region 7, 1(1), Stuttgart.
- Herting, B., 1961. Rhinophorinae. Pp. 1—36 in Lindner: Die Fliegen der paläarktischen Region, 64e Lfr. 216, Stuttgart.
- Herting, B., 1981. Typenrevisionen einiger paläarktischer Raupenfliegen (Dipt. Tachinidae) und Beschreibungen neuer Arten. — Stuttg. Beitr. Naturk. ser. A (Biologie) 346: 1—21.
- Howard, G. W., 1980. Immature stages and affinities of the southern lechwe warblefly, *Strobiloestrus vanzyli* Zumpt (Diptera: Oestridae). — J. Nat. Hist. 14: 669—683.
- Kloet, G. S. & Hincks, W. D., 1976. A check list of British Insects. Part 5: Diptera and Siphonaptera. — Handbks Ident. Br. Ins. 11 (5): ix + 139 pp.
- Kolubajiv, S., 1962. Die Ergebnisse der zuchten von entomophagen (der Parasiten und Räuber) der schädlichen Insekten (vorwiegend der forstschädlinge) in der Zeitperiode von 1934 bis 1958. — Rozpr. čsl. Akad. Ved 72(6): 1—73.
- Kugler, J., 1978. The Rhinophoridae (Diptera) of Israel. — Israel J. Ent. 12: 65—106.
- Kurahashi, H., 1966. Studies of the calypterate muscoid flies from Japan V. Revision of the tribe Luciliini (Diptera, Calliphoridae). — Sci. Rep. Kanazawa Univ. 11(2): 105—124.
- Lehrer, A., 1970. Considérations phylogénétiques et taxonomiques sur la famille Calliphoridae (Diptera). — Annotnes zool. bot., Bratislava 61: 1—51.
- Lehrer, A., 1973. La taxonomie du genre *Sarcophaga* Meigen (Fam. Sarcophagidae, Diptera). — Annotnes zool. bot., Bratislava 89: 1—22.
- Lopes, H. S., 1938. Sobre um Rhinophoridae e varios Sarcophagidae da colleção do "Deutsches Entomologisches Institut" em Berlin-Dahlen. — Mem. Inst. Oswaldo Cruz 33(4): 555—565, 4 pl.
- Lopes, H. S., 1966. Sobre Malacophasomyia g. n. (Diptera, Sarcophagidae) cujas larvas vivem em cadáveres de Gastropoda (Mollusca). — Revta bras. Biol. 26(3): 315—321.
- Lopes, H. S. & Kano, R., 1968. Studies on copulation of some sarcophagid flies (Diptera). Taxonomic importance of some features of male and female genitalia. — Revta bras. Biol. 28(3): 295—301.
- Lundbeck, W., 1927. Diptera Danica, genera and species of flies hitherto found in Denmark. Part 7. Platypzeidae, Tachinidae: 1—571. — G. E. C. Gad, Kobenhavn.

- McAlpine, J. F., Peterson, B. V., Shewell, G. E., Teskey, H. J., Vockeroth, J. R. & Wood, D. M., 1981. Manual of Nearctic Diptera 1: 1—674. — Biosystematics Research Institute, Ottawa.
- Mercier, L., 1921. La larve de *Limnophora aestuum* Villen., diptère marin. — C. r. hebdom. Séanc. Acad. Sci., Paris 173: 1410—1413.
- Mesnil, L., 1939. Essai sur les tachinaires (Larvaevoridae). — Monographies publiées par les stations et laboratoires de recherches Agronomique, Paris: 1—67.
- Mueller, A., 1926. Der Stammbaum der deutschen Tachiniden auf Grund der Penisform. — Nova Acta Acad. Caesar. Leop. Carol. 108(1): 1—30, 1 pl.
- Oldroyd, H., 1964. The natural history of flies: i—xiv, 1—324. — Weidenfeld and Nicolson, London.
- Pape, T., 1985. A new species of *Baniassa* Kugler from Iraq (Diptera: Rhinophoridae). — Ent. scand. 16: 209—211.
- Parker, H. L., 1953. Miscellaneous notes on South American dipterous parasites. — Boll. Lab. Ent. agr. Filippo Silvestri 12: 45—73.
- Reinhard, H. J., 1929. Notes on the muscoid flies of the genera *Opelousia* and *Opsodexia* with the description of three new species. — Proc. U.S. natn. Mus. 76(20): 1—9.
- Rikhter, V. A., 1980. Some plesiomorphic characters of the male genitalia in the family Tachinidae (Diptera). — Ent. Rev., Wash. 59(4): 162—171. (1982).
- Roback, S. S., 1954. The evolution and taxonomy of the Sarcophaginae (Diptera, Sarcophagidae). — Illinois biol. Monogr. 23(3—4): 1—181.
- Rohdendorf, B. B., 1948. A new family of parasitic muscoid Diptera from the sands of Transvolga. — Dokl. Akad. Nauk SSR 63: 455—458. (In Russian).
- Roubaud, M., 1903. Sur des larves marines de Dolichopodes attribuées au genre *Aphrosylus* (Wlkr.). — Bull. Mus. Hist. nat., Paris 9: 338—340.
- Sabrosky, C. W. & Crosskey, R. W., 1970. The type-material of Muscidae, Calliphoridae, and Sarcophagidae described by N. Baranov (Diptera). — Proc. Ent. Soc. Wash. 72: 425—436.
- Salzer, R., 1968. Konstruktionsanatomische Untersuchungen des männlichen Postabdomens von *Calliphora erythrocephala* Meigen (Dipt.). — Z. Morph. Ökol. Tiere 63: 155—238.
- Séguy, E., 1941. Études sur les mouches parasites. 2, Calliphorides. Calliphorines de l'Europe occidentale et meridionale. — Encycl. ent. (A) 21: 1—436.
- Steyskal, G. C., 1974. Recent advances in the primary classification of the Diptera. — Ann. ent. Soc. Am. 67(3): 513—517.
- Thompson, W. R., 1917. Sur un diptère parasite des isopodes terrestres (*Phyto melanocephala* Meig.). — C. r. Séanc. Soc. Biol. 80: 785—788.
- Thompson, R. W., 1920. Sur les diptères parasites des isopodes terrestres. — C. r. Séanc. Soc. Biol. 83: 450—451.
- Thompson, W. R., 1934. The tachinid parasites of woodlice. — Parasitology 26: 378—448, 8 pl.
- Townsend, C. H. T., 1935. Manual of myiology 2: 1—296, 9 pls. — Itaquaquecetuba, São Paulo.
- Townsend, C. H. T., 1938. Manual of myiology 4: 1—246. — Itaquaquecetuba, São Paulo.
- Verbeke, J., 1962. Contribution à l'étude des Tachinidae africains (Diptera). — Explors hydro-biol. des lacs Kivu, Edouard et Albert 3(4): 81—185.
- Wood, D. M., 1979. Tachinidae and Rhinophoridae. Pp. 418—419 in Danks: Canada and its insect fauna. — Mem. ent. Soc. Can. 108.
- Zumt, F., 1956. Calliphoridae (Diptera Cyclorhapha). Part I: Calliphorini and Chrysomyiini. — Explor. Parc natn. Albert. Miss. G. F. de Witte 87: 1—199.
- Zumt, F., 1959. Diptera (Brachycera): Calliphoridae. — S. Afr. anim. life 6: 427—440.







QL  
461  
T568  
Ent.

# TIJDSCHRIFT VOOR ENTOMOLOGIE

UITGEGEVEN DOOR

DE NEDERLANDSE ENTOMOLOGISCHE VERENIGING

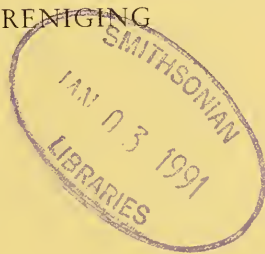

## INHOUD

H. K. PFAU. — Untersuchungen zur Konstruktion, Funktion und Evolution des Flugapparates der Libellen (Insecta, Odonata), pp. 35—123, figs. 1—30.





# UNTERSUCHUNGEN ZUR KONSTRUKTION, FUNKTION UND EVOLUTION DES FLUGAPPARATES DER LIBELLEN (INSECTA, ODONATA)

von

HANS KLAUS PFAU

Institut für Zoologie der Johannes Gutenberg-Universität, 6500 Mainz, Deutschland (B.R.D.)

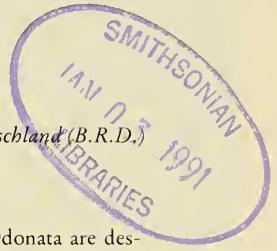

## ABSTRACT

The skeletal morphology and mechanics of the flight apparatus of the Odonata are described. The different types of muscle systems are functionally interpreted, taking into account various aspects of aerodynamics. — Electrophysiological experiments reveal a functional relationship between several mechanoreceptors located at the wing base (a chordonotal organ and two rows of campaniform sensilla) and the pronation-supination movements of the wing. — A comparison of the flight apparatus of Odonata with those of Ephemeroptera and Neoptera leads to the reconstruction of an ancient flight system in Pterygota. It may thus be concluded that flight ability has evolved only once, supporting the hypothesis of a monophyletic origin of the Pterygota. Within the Pterygota independent lineages have lead to highly autapomorphous characters in the flight apparatus of extant Odonata, Ephemeroptera and Neoptera. — The results of earlier research on functional morphology and evolution are discussed.

## INHALTSVERZEICHNIS

Einleitung .....	35
1. Skelettmorphologie, Skelettmechanik und Muskelfunktionen .....	36
Material und Methode .....	36
Skelettmorphologie .....	37
Flügelantrieb ("Flugmotor") .....	43
Drehbewegungen des Flügels um die Längsachse .....	46
Veränderung der Flügelschlagbahn — "Vor- und Zurückschwingen" des Flügels .....	57
2. Flügelmechanorezeptoren .....	62
Mechanische Beanspruchung der Rezeptoren .....	62
Elektrophysiologie der Rezeptoren .....	68
3. Evolution der Flugapparate der Odonaten, Ephemeropteren und Neopteren .....	75
4. Diskussion und Ergänzungen .....	91
Flügelmechanik, Muskelfunktionen und aerodynamischer Effekt .....	91
Sensorische Kontrolle und Flugsteuerung .....	101
Evolution .....	104
Die Muskelfunktionen im tabellarischen Vergleich .....	111
Danksagung .....	117
Zusammenfassung — Summary .....	117
Abkürzungen .....	121
Literatur .....	122

## EINLEITUNG

Die Odonata (Libellen) sind stammesgeschichtlich alte, palaeoptere Insekten, die relativ

unverändert bis ins Karbon zurückreichen (Hennig, 1969). Ihre stark autapomorphe Prägung macht eine systematische Einordnung innerhalb der Pterygota schwer. Mehrere Möglichkeiten wurden schon durchgespielt und begründet (s. die Zusammenfassungen und kritischen Kommentare von Hennig, 1969, Kristensen, 1975 und Matsuda, 1981). Dabei spielte die Beurteilung verschiedener Merkmale des Flugapparates eine große Rolle. Matsuda (1981) etwa postulierte eine polyphyletische Entstehung der Pterygota (und unabhängige Entwicklung der Flugfähigkeit bei Odonaten einerseits und Ephemeropteren + Neopteren andererseits), wobei er sich wesentlich auf Homologie- und Funktionsinterpretationen der grundlegenden Bearbeitung des Odonaten-Flugapparates von Tannert (1958) bezog. Er deutete allerdings an, daß Schwierigkeiten existieren, die einem direkten Nachvollziehen (und Begreifen) der Ergebnisse Tannert's im Wege stehen: "Wing articulation, especially that of Odonata, is difficult to study. At one time, while working on the insect thorax (Matsuda, 1970), I gave up studying wing articulation in Odonata after a few hours attempt, and decided to rely completely on the work by Tannert (1958), which must have been completed after years of study". Ohne genaue Kenntnis und Bewertung der Struk-

turen und Funktionen (die sich erst als Ergebnis komplizierter, wechselseitiger Erhellungen ergeben; vgl. Hennig, 1950, 1982) stehen stammesgeschichtliche Hypothesen aber auf einem schwachen Fundament. Das Beispiel der umstrittenen Evolution der Pterygota zeigt deutlich, daß Übereinstimmungen fast beliebig entweder als Konvergenzen, Symplesiomorphien oder Synapomorphien interpretiert und begründet werden können. Es ist aber für eine Entscheidung zwischen diesen Möglichkeiten notwendig (wenn auch leider in vielen Fällen noch nicht möglich), Rekonstruktionen der Grundpläne und der davon ausgehenden, natürlich auf jeder Stufe funktionsfähigen evolutiven Abwandlungen durchzuführen — unter Berücksichtigung des Funktionszusammenhanges der Strukturen im ganzen "Apparat" und auch der ökologischen Wertigkeit des Apparates. Die Beurteilung der Merkmale des Odonatenflugapparates darf schon deshalb keineswegs kommentarlos allein auf die Arbeit von Tannert gestützt werden, weil auch andere Autoren zu akzeptabel erscheinenden, im einzelnen aber abweichenden Ergebnissen kamen. Russenberger & Russenberger (1959/60) vermitteln z.B. in ihrer (in der Literatur wenig beachteten) Arbeit einen umfassenden Einblick in die Konstruktion des Odonatenflugapparates; ihre Ergebnisse zur Mechanik des Skeletts wurden anschaulich dokumentiert und mit Hilfe von Modellen untermauert. In der angelsächsischen Literatur sind vor allem die Arbeiten von Clark (1940), Neville (1960) und Hatch (1966) zu nennen. Vergleicht man die Ergebnisse dieser Autoren untereinander, und mit den Befunden von Tannert, so findet man grundsätzliche Unterschiede (sowie auch Widersprüche und Unklarheiten innerhalb der einzelnen Arbeiten). Eine Entscheidung zwischen den verschiedenen Hypothesen ist jedoch ohne eigene Anschauung und Bewertung nicht möglich.

Diese Situation machte eine Neubearbeitung des Libellenflugapparates (der offensichtlich für die Klärung wesentlicher stammesgeschichtlicher Fragen von Bedeutung ist) notwendig. Dabei wurde erneut von einer Analyse der Thorax- und Flügelmechanik ausgegangen; v.a. dieser Weg bietet sich als der primäre Zugang zum Verständnis des Flugapparates an (Experimente an vor dem Windkanal fliegenden Libellen bringen dagegen erhebliche Schwierigkeiten mit sich — ihre Interpretation wäre außerdem ohne die funktionsmorphologische Basis kaum möglich). Darauf aufbauend wurde der Versuch unter-

nommen, die Funktion der Flugmuskeln (Kraftwirkungen, Zeitpunkt der Kraftentwicklung, antagonistische Kraftbeziehungen) zu erschließen, und — mit Hilfe (sicher vorläufiger) aerodynamischer Überlegungen — auch ihre Bedeutung für den Flug abzuschätzen. Die Analyse der Flügelmechanik stellte außerdem eine Voraussetzung für die Untersuchung mechanorezeptiver, für die Flugsteuerung wesentlicher Sinnesorgane des Flügels dar. Die Ergebnisse zur mechanischen Beanspruchung und Funktion der Rezeptoren wurden elektrophysiologisch und mit Hilfe von Funktionsmodellen überprüft.

Ein Hauptziel der Untersuchungen war die Erhellung der Evolution des Flugapparates der Odonaten — und auch der übrigen Pterygoten. Voraussetzung dafür ist eine vergleichende Analyse aller drei rezenten Teilgruppen der Pterygota, also der Odonaten, Ephemeropteren und Neopteren. In der Literatur über die beiden letztgenannten Gruppen finden sich jedoch wiederum v.a. morphologische Detailbeschreibungen; die Funktionsmorphologie der Flugapparate wird (wie im Falle der Odonata) keineswegs genügend berücksichtigt und nicht übereinstimmend beurteilt. (Im Hinblick darauf unterliegt Matsuda (1981), der unsere Kenntnisse der außerordentlich komplizierten Flügelgelenkung der Ephemeroptera für ausreichend hält, einem Irrtum.) Auch für diese Gruppen mußte daher von eigenen Ergebnissen und Bewertungen ausgegangen werden.

## 1. SKELETTMORPHOLOGIE, SKELETTMECHANIK UND MUSKELFUNKTIONEN

### MATERIAL UND METHODE

Das Skelett- und Muskelsystem des Thorax wurde durch Sektion v.a. an großen Anisopteren (*Aeshna cyanea* Müll., *Aeshna mixta* Latr., *Anax imperator* Leach), zum Vergleich auch an verschiedenen Zygopteren und der Gattung *Epiophlebia* Calvert (als Vertreter der Anisozygopteren), untersucht. Parallel dazu wurden Mazerate herangezogen.

Die Skelettmechanik kann nur an frischtoten Tieren analysiert werden (auch nach dem Einfrieren in stark verdünntem Alkohol sind Libellen noch lange für Bewegungsuntersuchungen brauchbar). Zur Feststellung von Lage und Zusammenspiel der Gelenke wurden verschiedene Experimente durchgeführt: die Teile des Flügels wurden z.B. von außen bewegt; die Bewegun-



gen wurden durch Zug an den Muskelsehnen ("von innen") überprüft; einzelne Gelenke wurden festgelegt oder durchtrennt; u.s.w. Zur Kontrolle wurden mechanische Modelle angefertigt (u.a. auch ein Gesamtmodell, das alle Bewegungsmöglichkeiten enthält — PfaU, in Vorb.). Einige wesentliche Gelenk- oder Biestellen der Kutikula (v.a. der Flügelbasis) liegen so versteckt, daß eine direkte Beobachtung an intakten Strukturen unmöglich ist. In diesem Fall mußten die Teile freipräpariert, oder ganz aus dem Zusammenhang isoliert, untersucht werden (so mußte z.B. die Oberseite der Flügelbasis für eine gleichzeitige Sicht auf die mit wichtigen Gelenken versehene ventrale Kutikula gefensternt werden). Da jeder Eingriff auch zu Veränderungen der Mechanik führen kann, war es notwendig, an Einzelteilen gewonnene Ergebnisse jeweils an vollständigen Strukturen erneut zu überprüfen.

Die Flügelbasis erwies sich als kompliziert ("verschachtelt") gegliedert. Die Analyse der Mechanik wird z.T. dadurch erschwert, daß einer Bewegung auch mehrere Drehachsen zugrundeliegen können — daraus resultierende Verformungen von Teilen führen dann während des Bewegungsablaufs zur Veränderung der Achsen-Ausrichtung(en). Kaum eine Drehachse ist stabil. Übergeordnete Bewegungen (etwa der Flügelschlag) können die Lage von Achsen so verändern, daß andere (untergeordnete) Bewegungen in bestimmten Abschnitten des Schlags eingeschränkt oder vollständig gesperrt werden. Diese Komplikationen machen es notwendig, bei der Beschreibung und zeichnerischen Darstellung der Skelettmechanik starke Abstraktionen vorzunehmen.

Die Muskeln des Flugapparates sind oft "zwischen" den verschiedenen Bewegungssystemen angeordnet, weisen also Hebelarme zu mehreren Drehachsen auf ("polyfunktionelle Muskeln"). Aus der wechselseitigen Abhängigkeit der Systeme, oder aus ihrer mechanischen Begrenzung, lassen sich in einzelnen Fällen Schlüsse auf die zeitliche Einschaltung und Funktion eines Muskels ziehen. Da direkte Informationen über Kontraktionsstärke und -zeitpunkt fehlen (und die beim Flug wirkenden passiven Kräfte auch höchstens geschätzt werden können) mußte das Zusammenspiel der Kräfte in dieser Weise (hypothetisch) rekonstruiert werden.

#### SKELETTMORPHOLOGIE

In diesem Kapitel soll die Morphologie der thorakalen und pteralen Strukturen nur kurz um-

rissen werden — eine genauere Darstellung weiterer Details wird in den folgenden Kapiteln vorgenommen.

Bei der Beschreibung des Tergum wird hier zunächst v.a. das Mesotergum berücksichtigt. Während Vorder- und Hinterflügel (sowie Meso- und Metapleurum) weitgehend gleich aufgebaut sind, unterscheiden sich Meso- und Metatergum stärker voneinander; darauf soll auf S. 61f. noch näher eingegangen werden. Der Aufbau des Tergum wird nur für seine vordere bis mittlere Region dargestellt; kaudal-lateral ist das Tergum vielseitig biegsam (weicher) und "folgt" den verschiedenen Flügelbewegungen ohne wesentlichen mechanischen Einfluß (es ist dort also auch nicht hebelnd am Flügelschlag beteiligt). Das Sternum (höchstens als Ursprungsgebiet einiger hier behandelter Muskeln interessant) wird ganz weggelassen. (Detaillierte morphologische Beschreibungen finden sich in älteren Arbeiten; Zusammenfassung bei Matsu-da, 1970.)

Bis auf wenige Ausnahmen werden nur solche Teile beschrieben und benannt, die als funktionelle Einheiten (= Bewegungseinheiten) zu erkennen sind. Da in der Beurteilung der Funktion (und der Abgrenzung von Funktionseinheiten) wesentliche Unterschiede zu vorhergehenden Arbeiten bestehen, müssen zum Teil neue Bezeichnungen eingeführt werden. Einige ältere Homologievorstellungen konnten nicht bestätigt werden. Die fraglichen Strukturen (z.B. Pterale 1, Basalare) werden hier zunächst so neutral wie möglich benannt; auf ihre Homologie wird v.a. im Kapitel 3 näher eingegangen.

#### Tergum

Auf der Höhe des Flügelvorderrandes befindet sich ein stabiles vorderes Randlement des Tergum, die Tergalbrücke (Tb, Abb. 1—5). Sie verbindet die Costalplatten (CP, Abb. 1a und 3) des rechten und linken Flügels. Die Tergalbrücke steht auf beiden Seiten über ein Gelenk (t1) mit der Unterseite der dorsalen Wandung der vorderen Costalplatte (vCP, Abb. 3) in Kontakt. Von ihrer Mitte ragt ein unpaares Apodem ins Körperinnere, das Hebelapodem (HA, Abb. 1); es bildet Ansatz und Hebel (vgl. S. 58f.) der dorsalen Längsmuskeln (dlm, Abb. 1 und 2).

An die Tergalbrücke schließt eine mittlere Region des Tergum (T, Abb. 1a und c) an. Diese ist etwa in der Segmentmitte auf beiden Seiten laterad zu je einem "Tergalzapfen" (TZ, Abb. 1a) ausgezogen, der zusammen mit einem da-





Abb. 1. (a) Blick von dorsal-medial auf das Mesotergum und die Basis des rechten Vorderflügels einer Aeshnide. Hinter der Tergalbrücke (Tb) ist das Segment durch einen Sagittalschnitt geöffnet, so daß Apodeme und Muskeln zu sehen sind. Membran fein punktiert — einige besonders verstärkte Membranstellen wurden hervorgehoben: zwischen Tb und vTS (vgl. S. 60), zwischen CP und RS (vgl. S. 51) und zwischen TZ und RAP (bei t2). Dorsaler Ansatz des Chordotonalorgans (CH) schraffiert. TZ, G2 und t2 liegen in Wirklichkeit vertieft. (b) Schema des Vorschwingmechanismus des Vorderflügels (Ansicht wie in a). CP\* und RAP zu soliden Platten vereinfacht, der Tergum-Mittelnbereich (T in a) als 2-armiges Gestänge dargestellt. Bewegte Elemente schraffiert. (c) Tergale Mechanik — noch stärker vereinfacht: Das Hebelapodem (HA) wurde auf die Höhe des t1-Gelenks versetzt, wodurch der vom dlm genutzte Hebel zum Ausdruck kommt.



Abb. 2. Flugmuskulatur. Blick von hinten-oben auf das mesothorakale Segment. Flügelbasis durchsichtig gedacht, Tergum weitgehend entfernt, Pleuralleiste und pleurale Gelenkköpfe dunkel hervorgehoben. Die Muskeln wurden zur besseren Übersicht weit voneinander getrennt. Nur der dlm ist paarig dargestellt. Linke Körperseite: Muskeln des Flugmotors (punktiert); Mitte und rechte Seite: Vor- Zurückschwingmuskeln (gekreuzt schraffiert) und pronatorisch-supinatorische Drehmuskeln (schraffiert). pa nur bei Zygopteren und *Epiophlebia*, dlm im Metathorax der Anisoptera reduziert. Muskelfunktionen s. Tabelle 1, S. 112f.

hinter liegenden Gelenksklerit ("2. Gelenksklerit" G2, Abb. 1a) eine komplizierte Gelenkstelle zwischen Tergum und Radioanalplatte (RAP, Abb. 1a) ausbildet.

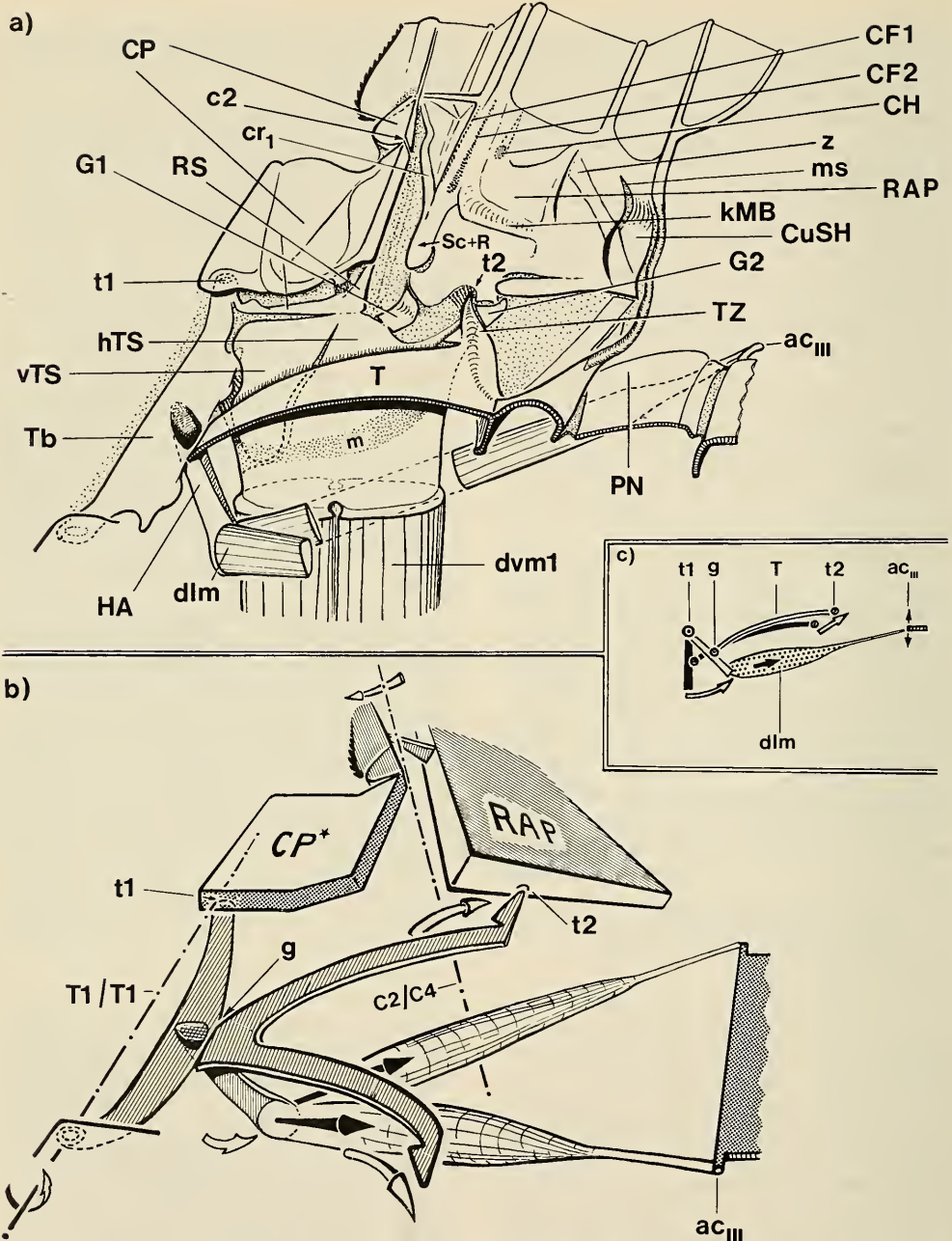
Zwischen Tergalzapfen und Tergalbrücke liegt, lateral von der Tergummittenregion, ein morphologisch komplexer Seitenbereich des Tergum. Hier ist (rechts und links) das Apodem des großen Dorsoventralmuskels (dvm1, Abb. 1a und 2) ins Körperinnere versenkt. (Außer dem dvm1 dient das Apodem auch den Muskeln dvm2 und tp sowie einem Tergocoxalmuskel als Ursprungs- bzw. Ansatzgebiet.) Die mediale Wand der doppelwandigen Einstülpung geht, von einer schmalen Membranzone (m) unterbrochen, in die Tergummittenregion (T) über, die laterale Wand tritt (über weitere Sklerite und Membranen) mit dem Flügel in Beziehung. Die Lateralwand wird hier als Tergalsklerit bezeichnet. Dieser Sklerit ist bei Anisopteren im Metathorax einteilig, im Mesothorax dagegen durch ein Gelenk in zwei Teile gegliedert (vorderer Tergalsklerit vTS und hinterer Tergalsklerit hTS, Abb. 1a; vgl. auch S. 59f. — für Zygopteren und *Epiophlebia* s. S. 109f.).

Der vordere Tergalsklerit<sup>1)</sup> ist vorn gelenkig mit der Tergalbrücke verbunden (vgl. Abb. 1a und S. 60) und besitzt lateral ein in Tierlängsrichtung verlaufendes Gelenk zu einem hier als Randsklerit bezeichneten Seitenelement (RS, Abb. 1a und 3). Der untere Abschnitt des vorderen Tergalsklerits bildet das Ursprungsgebiet des Tergopleuralmuskels (tp, Abb. 2 und 5).

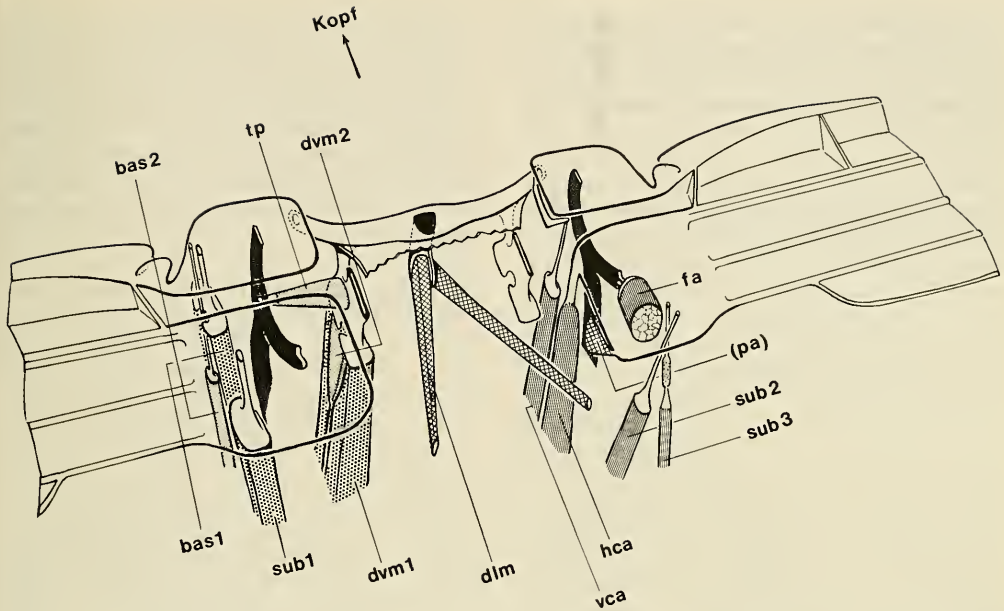
Der Randsklerit, der sich schmal zwischen dem vorderen Tergalsklerit und der Costalplatte in der Tierlängsrichtung erstreckt, ist vorn am Costalplatten-Tergalbrücken-Gelenk t1 beteiligt (Abb. 1a, 2 und 3); hinten ist er laterad zu einem in den Flügel hineinragenden Zipfel, dem Ansatz des vorderen Coxoalarmuskels (vca, Abb. 2 und 3), ausgezogen.

Der hintere Tergalsklerit ist kaudal mit dem Tergalzapfen TZ verwachsen (Abb. 1a). Kurz davor vermittelt ein kleines Skelettelement, der

<sup>1)</sup> Das gut abgrenzbare Skelettelement wird in der Literatur oft mit dem Pterale 1 der neopteren Insekten homologisiert (vgl. Matsuda, 1970, l.c. S. 390). Dafür spricht jedoch weder seine Lage noch seine Muskulatur (s. auch S. 84 und 88).

“1. Gelenksklerit” (G1, Abb. 1a), ebenfalls zur Radioanalplatte. Direkt am lateralen Gelenk dieses Sklerits (dem Gelenk zur Radioanalplatte) inseriert der hintere Coxoalarmuskel (hca, Abb. 2 und 3).

Pleurum

Die Pleuralleiste verzweigt sich am oberen Ende in die beiden Flügelgelenkköpfe, den vor-

deren Gelenkkopf und das Fulcrum (vGK, F; Abb. 2 und 3). Diese Gelenkköpfe bilden, zusammen mit der Costal- bzw. Radioanalplatte, die pleuralen Hauptgelenke des Flügels (p1 und p2; Abb. 7). Dicht bei der dorsalen Verzweigungsstelle der Pleuralleiste inseriert der Tergopleuralmuskel tp (Abb. 2 und 5), der weiter medial von der Seitenwand des dvm1-Apodems entspringt.



Abb. 3. Schema der Basis des rechten Flügels einer Aeshnide (Blick von medial-dorsal). Die Membran zwischen den Skleriten wurde fast überall entfernt, die RAP dorsal aufpräpariert; dadurch werden Strukturen in der RAP (CH, fa) sowie die Flügelunterseite und das Pleurum (letztere eng schraffiert) sichtbar. Die Muskeln beider Drehbereiche des Flügels wurden eingezeichnet (bis auf den bei x<sub>2</sub> ansetzenden sub1, der v.a. als Senker zu betrachten ist). x<sub>1</sub> kennzeichnet die Angriffsstelle des reinen direkten Senkers bas1. Die Ausrichtung des Flügel-Chordotonalorgans (CH) wurde (zur besseren Sicht auf das vordere Epifulcrum-Gelenk) geringfügig verändert (vgl. Abb. 1a).



Der vordere Gelenkkopf ist eine Bildung, die nur den Odonaten zukommt (vgl. Kapitel 3). Die an dieser Stelle brückenartig verbundene Dorsal- und Ventralwandung der (auf dem vGK aufliegenden) Costalplatte (Abb. 7) wäre damit als Analogie zur durchgängigen Sklerotisierung des Pterale 2 der Neopteren auf der Höhe des (hinteren!) Gelenkkopfes (Fulcrum) anzusehen. Die funktionelle Bedeutung der Stabilisierungen ist leicht einzusehen: in beiden Fällen entsteht durch Verschmelzung der Wandungen eine besonders verfestigte Auflagestelle des Flügels auf einem pleuralen Gelenkkopf.

Die sog. Epipleurite, Basalare 1 und 2 und Subalare, die bei der Mehrzahl der Pterygoten im dorsalen Bereich des Pleurum liegen, sind bei Odonaten nicht ohne weiteres aufzufinden: Das Basalare 2 wird hier — in grundsätzlicher Abweichung zu bisherigen Auffassungen — als ein ursprünglicher, vorn in der Flügelbasis befindlicher Teil des Flügels aufgefaßt; das Basalare 1 dagegen als eine pleurale Neubildung der Neopteren, die bei Odonaten (und Ephemeropteren) — noch nicht gelenkig abgesetzt — als fester Bestandteil des Pleurum vorliegt (vgl. Kapitel 3). Der hinter dem Fulcrum liegende Epipleurit, das Subalare, ist bei Libellen als ein kleiner Sklerit im oberen Sehnenabschnitt des Muskels sub1 zu erkennen (es wurde hier nicht abgebildet); allerdings kann die Homologie nicht gesichert werden (vgl. auch S. 42). Der Sklerit hat für die Mechanik des Flügels keine Bedeutung — er dient wohl v.a. der Verstärkung der Sehne des großen Senkermuskels.

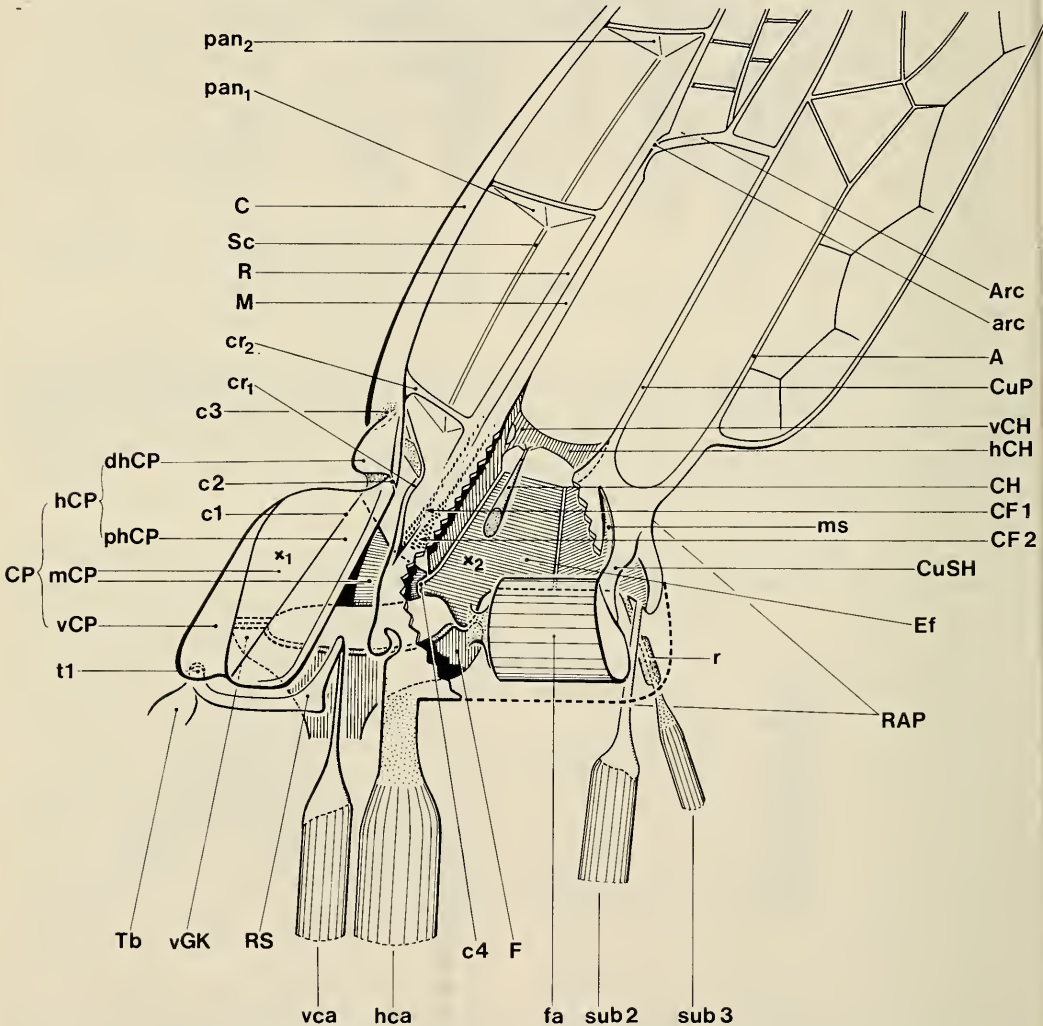
### Flügelbasis

Die Flügelbasis ist aus zwei größeren Elementen, Costalplatte und Radioanalplatte<sup>1)</sup> (CP, RAP; Abb. 1a und 3), aufgebaut. Während eine der Radioanalplatte äußerlich ähnliche Sklerotisierung auch in der Flügelbasis der Ephemeropteren aufzufinden ist, bereitet die Homologisierung der Costalplatte (zumindest ihres proximalen Hauptteils) größere Schwierigkeiten. Verschiedene Autoren haben das Problem dadurch gelöst, daß sie die Costalplatte insgesamt mit der Humeralplatte anderer Insekten homologisierten (s. z.B. Hennig, 1969, l.c. Abb. 25, oder Matsuda, 1970, 1979) und demzufolge annahmen, daß in der Flügelbasis der Odonaten zwei Humeralplatten existieren. In der vorliegenden Arbeit wird nur die "distale

Costalplatte" Tannert's mit der Humeralplatte homologisiert (vgl. Kap. 3).

Die abweichende bisherige Homologisierung der Costalplatte beruht wohl z.T. darauf, daß die vorderen Epipleurite, die Basalaria, bei Odonaten nicht (wie "üblich") vorn unter der Flügelbasis anzutreffen sind. Einige Bearbeiter (z.B. Clark, 1940; Chao, 1953; Asahina, 1954) schlossen daraus, daß die große Kappensehne des Basalarmuskels als das ins Körperinnere versenkte Basalare zu betrachten ist. An die Kappensehne würde dann folgerichtig zum Flügel hin die Humeralplatte anschließen. Nach Matsuda (1981), der eine unabhängige Evolution der Flugfähigkeit der Odonaten annimmt, fehlen die Epipleurite bei Libellen jedoch von vornherein (l.c. S. 391f.).

In der Costalplatte (CP) können drei Teile unterschieden werden: vordere, mittlere und hintere Costalplatte (vCP, mCP und hCP; Abb. 3). Diese Bezeichnungen werden in Anlehnung an Tannert (1958) verwendet. Zur hinteren Costalplatte wird hier jedoch auch die "distale Costalplatte" Tannert's gerechnet. Die hCP besteht damit aus der proximalen hinteren Costalplatte (phCP, Abb. 3; "regio posterior der proximalen Costalplatte" bei Tannert) und der distalen hinteren Costalplatte (dhCP, Abb. 3; "distale Costalplatte" bei Tannert; Humeralplatte bei anderen Autoren, vgl. Kap. 3). Diese Benennungsänderung soll die Darstellung erleichtern und der engen funktionellen Beziehung von phCP und dhCP bei Pronations-Supinationsbewegungen (im Abschlagsdrehbereich, vgl. S. 47ff.) gerecht werden.

Die Unterseite der mittleren Costalplatte bildet, zusammen mit dem vorderen Gelenkkopf (vGK), das vordere pleurale Hauptgelenk p1 des Flügels (Abb. 3 und 7). Wenig lateral davon inserieren der große, direkte 1. Basalarmuskel sowie der viel schwächere 2. Basalarmuskel (Abb. 2: bas1, bas2; Ansatzstelle des bas1 bei x<sub>1</sub> in Abb. 3). Die Unterseite der mittleren Costalplatte ist nach kaudal verlängert (dieser Abschnitt entspricht dem Basalare 2 der Neopteren, vgl. oben und Kap. 3) und tritt über ein Gelenk mit der Radioanalplatte in Verbindung (c4, Abb. 3, 7, 9 und 10). Die übrigen, dorsalen Gelenke der Costalplatte werden weiter unten und auf den S. 48f., 58 beschrieben.

Während die Costalplatte sich distad nur in der Costa fortsetzt, stellt die Radioanalplatte (RAP) das Ausgangsgebiet der übrigen Flügel-längsadern dar. Sie ist (im Gegensatz zur CP)

<sup>1)</sup> Radius-Analis-Platte bei Tannert (1958).

nicht scharf abzugrenzen, da ihre vorderen und hinteren Bereiche funktionell zum distalen Flügel (den "Flügelsektoren", vgl. S. 43 und S. 46ff.) zu rechnen sind. Außerdem ist die RAP nicht (wie andere Autoren annahmen; vgl. Tabelle 1, S. 112f.) für sich gegenüber der CP beweglich. Der Begriff RAP umfaßt daher eigentlich keine Funktions- (= Bewegungs-) Einheit — er wurde dennoch hier zur Kennzeichnung eines morphologisch abgrenzbaren Flügelteils beibehalten. Wie bei Tannert (1958) wird auch die Sklerotisierung der Unterseite der Flügelbasis (kaudal von der ventralen mCP) zur RAP gerechnet. Die RAP stellt somit eigentlich keine Platte, sondern eine doppelwandige "Auf-treibung" der Flügelbasis dar. Durch sie kann man nach distal — wie bei einem Handschuh in die Finger — in die einzelnen Flügellängsadern gelangen (nach cranial ist der "Handschuh" zur CP hin offen, ebenso nach proximal-ventral zum Thorax-Lumen; Abb. 3).

Die komplizierten Verformungen der RAP bei Drehbewegungen des Flügels um Längsachsen (S. 46ff.) lassen innerhalb der RAP vier verschiedene Funktionsteile erkennen:

1. — In der Mitte der Unterseite der RAP liegt ein Sklerit, der vorn und hinten durch (gut "gängige") Scharniergelenke (e1, e2, Abb. 7) scharf begrenzt ist. Er wird hier als Epifulcrum (Ef, s. Abb. 3 und 7) bezeichnet. Verstärkungsleisten der Innenwand des Epifulcrum (Abb. 10) sorgen dafür, daß der Sklerit nur schwer verformbar ist und so bei den Flügel-Verwindungsbewegungen (S. 46ff.) ein stabiles Widerlager bildet. Dieser wichtige (bisher anscheinend noch nicht beschriebene und nur bei Odonaten abgrenzbare) Sklerit bildet proximal den Gelenkauflegepunkt des Flügels auf dem Fulcrum (p2). Wenig distal davon setzt der kräftige 1. Subalarmuskel (sub1, Abb. 2; Ansatzstelle bei  $x_2$  in Abb. 3) am Epifulcrum an. Er ist, wie der bas1, mit einer langen, hart sklerotisierten Kappensehne versehen, die dorsal in eine membranöse Sehne übergeht. Im membranösen Teil der Sehne ist ein kleiner Sklerit, wahrscheinlich der Rest des Subalare, zu erkennen (deutlich v.a. bei Zygopteren).

Man könnte auch das Epifulcrum selbst mit dem Subalare homologisieren, das dann bei Odonaten in der Flügelbasis "inkorporiert" wäre (vgl. auch die entsprechende Lage des hinteren, zweiten Basalare im Flügel — s. S. 41 und Kap. 3). Da es jedoch nur schwer vorstellbar ist, daß das Subalare die Stelle der ventralen Flügelbasis, die vorher dem Fulcrum auflag,

verdrängt hat oder umgekehrt bei den übrigen Pterygoten sekundär aus dem Flügel ausgewandert ist (dann würde bei Odonaten ein nicht-homologes Fulcrum/Flügelgelenk vorliegen), ist das Epifulcrum wohl eher als ein Teil der ursprünglichen ventralen, dem hinteren Gelenkkopf aufliegenden Flügelbasis zu betrachten.

2. und 3. — An das Epifulcrum schließen vorn und hinten Seitenelemente der RAP an, die funktionell als Basisteile des distalen Flügels (der Flügelsektoren, in welche sie ohne gelenkige Abgrenzung übergehen; vgl. S. 43) aufzufassen sind. Sie werden als Costalsektor-Basis und Cubitalsektor-Basis bezeichnet (CoSB, CuSB; Abb. 7). Während die Unterseite dieser Teile (hinten bzw. vorn) mit dem Epifulcrum die schon beschriebenen Scharniergelenke e1 und e2 bildet, ist die Wand ihrer Oberseite in der RAP nicht deutlich abgegrenzt: die Costalsektor-Basis endet kaudal an einer (nur bei Bewegung der Teile sichtbaren) Biegezone in der RAP-Oberseite, die dem vorderen Epifulcrum-Gelenk e1 der Flügelunterseite gegenüber liegt und ungefähr parallel zu ihm verläuft (vgl. S. 47ff.); die Cubitalsektor-Basis ist dorsal in komplizierter Weise über Biegestellen (die ebenfalls erst bei Bewegung erkennbar sind) "eingelenkt" (vgl. S. 53ff.).

Nach vorn — zum Membranspalt zwischen RAP und CP (Abb. 1a) hin — ist die CoSB durch eine diagonal zur Costa ziehende, ader-ähnliche Verdickung (cr<sub>1</sub>, Abb. 3) begrenzt. Dort, wo diese auf die Costa trifft, besitzt die CoSB (bzw. die RAP) ein Gelenk zur (hinteren) Costalplatte (c3, Abb. 3). Die ventrale Wandung beider RAP-Seitenteile (CoSB und CuSB) ist auf der Innenseite mit Verstärkungsleisten versehen (Abb. 10), die — ähnlich wie die entsprechenden Bildungen des Epifulcrum — eine Verformung der Teile bei den Verwindungsbewegungen (vgl. S. 46ff.) verhindern.

4. — Die verbleibende, dorsal zwischen CoSB und CuSB liegende mittlere Zone der RAP wird hier — da sie nur schwer abzugrenzen ist (s. oben) — nicht gesondert bezeichnet.

Außer den beiden schon erwähnten Basalarmuskeln (bas1 und bas2) steht noch ein weiterer Muskel mit der CP in einer Beziehung, der vordere Coxoalarmuskel vca. Er bewegt (indirekt, über den Randsklerit RS wirkend; vgl. S. 39 und 51) die hCP nach unten. Zur RAP ziehen (außer dem 1. Subalarmuskel) noch vier (bei Zygopteren und *Epiophlebia* fünf) weitere Muskeln (Abb. 2 und 3). Auf diese soll auf S. 46ff. und 57ff. näher eingegangen werden.



## Flügel

Distal von der Costal- und Radioanalplatte beginnt die eigentliche Flügelspreite. Sie besteht aus 2 Hauptteilen, die nach ihrer (proximalen) vorderen Randader benannt werden: Costalsektor und Cubitalsektor (CoS, CuS; Abb. 8).

Der Costalsektor umfaßt die Fläche zwischen Costa und Radius (basal incl. Media) bis zum Nodus-Gelenk (n, Abb. 8). Diese Fläche wird durch stabile Queradern zwischen Costa und Radius versteift ( $cr_2$ , pan1, pan2; Abb. 3). Proximal-vorn tritt der CoS (über das Gelenk c3) mit der hinteren Costalplatte in Beziehung (vgl. S. 41f.), proximal-kaudal geht er (als CoSB) in die Radioanalplatte über.

Der Cubitalsektor, der proximal den Cubitus (CuP: Cubitus posterior; s. Abb. 3 und 8) und die Analis (A) als Hauptadern enthält, ist über den Arculus (Arc), und andere Queradern bis hin zum Nodus, gelenkig mit dem Costalsektor verbunden. Seine Basis (CuSB) bildet, wie weiter oben beschrieben wurde, einen kaudalen Abschnitt der RAP. Innerhalb des Cubitalsektors kann kaudal noch ein (v.a. bei Anisopteren im Hinterflügel großer) Analsektor unterschieden werden. Dieser Teil ist für sich anscheinend nicht aktiv beweglich. Er spielt wohl bei der Verwölbung des Flügels (bei pronatorischer Verwindung) eine Rolle (vgl. S. 49f. und S. 54).

Die beiden Flügelsektoren sind in Wirklichkeit nicht scharf gegeneinander abgrenzbar. Sie gehen distal — da bei den Verwindungsbewegungen zur Flügelspitze hin mehr und mehr der ganze Flügel erfaßt wird — ineinander über. Je nachdem, ob der Flügel pronatorisch oder supinatorisch verwunden wird, betrifft dies die mittleren und distalen Bereiche der Sektoren jedoch in unterschiedlicher, nicht symmetrischer Weise (vgl. S. 46ff.).

## FLÜGELANTRIEB ("FLUGMOTOR")

Der Flügel wird beim Auf- und Abschlag um die (durch die beiden pleuralen Hauptgelenke p1 und p2 gebildete) Scharnierachse P1/P2 (Abb. 7) bewegt. Der dorsoventrale indirekte Hebermuskel *dvm1* hebt den Flügel (durch Senkung des Tergum) nach oben, die direkten Senker *bas1* und *sub1* ziehen ihn nach unten (Abb. 2, 4 und 5).

Libellen fliegen demnach mit einem "indirekt-direkten" Schlagmechanismus (vgl. z.B. Weber, 1933, l.c. S. 167; Pringle, 1957; Tannert, 1958). Neuerdings (vgl. z.B. Snodgrass, 1958; Nachtigall, 1968; Hennig, 1969, 1972; Hadorn

& Wehner, 1974; Schneider & Günther, 1978) wird der Flügelschlagmechanismus der Odonaten jedoch als Antagonismus direkter (!) Heber und direkter Senker beschrieben, und ausgehend davon auch gefolgert, daß die Flügel der beiden Seiten unabhängig voneinander (also auch gegenläufig) geschlagen werden könnten. So dargestellt, und als Besonderheit der Libellen verallgemeinert, ist dies falsch. Einerseits greifen die *dvm1* nicht direkt am Flügel an; andererseits sind rechter und linker Flügel durch die starre Tergalbrücke (Tb), an der die indirekten Hebermuskeln der beiden Seiten mittelbar angreifen, gekoppelt (Abb. 1a, 2, 4 und 5). Eine gegenläufige Aktion der eng beieinanderliegenden Hebermuskeln der beiden Körperseiten (in den Abb. wurden sie aus Darstellungsgründen weiter auseinander gerückt) ist unwahrscheinlich und wurde bisher auch nicht nachgewiesen (vgl. dazu auch S. 45f. und Anm. 11, S. 115). (Entsprechendes betrifft natürlich auch die direkten Senker der beiden Seiten, welche die Ausgangsposition des Tergum, für einen erneuten Aufschlag, wiederherstellen.) Schließlich ist der Subalarmuskel, der, zurückgehend wohl auf Weber (1933), auch für Libellen als direkter Heber verkannt wird (vgl. Schneider & Günther, 1978), mit Sicherheit ein Senker, so daß ein (unilateraler) Antagonismus direkter Basalar- und Subalarmuskeln ebenfalls nicht vorliegt.

Die verbreitete Ansicht, daß Libellen einen "rein direkten" Flugmechanismus besitzen, geht z.T. anscheinend darauf zurück, daß medial der pleuralen Gelenkköpfe tatsächlich auch direkte Heber am Flügel angreifen; entsprechend ihrer geringeren Stärke können diese Muskeln jedoch nicht als Haupt-Antriebsmuskeln angesehen werden — es sind eindeutig Stellmuskeln mit akzessorischer Antriebsfunktion (vgl. S. 47ff. und S. 97f.). Die davon gut abgesetzten, weiter medial verlaufenden indirekten Heber (*dvm1*) sind viel mächtiger und greifen deutlich am Tergum an; merkwürdigerweise werden sie oft nicht beachtet. Daß die Libellen wahrscheinlich phylogenetisch auf Vorfahren zurückgehen, die auch beim Abschlag einen indirekten Antriebsmuskel, den dorsalen Längsmuskel, einsetzen, wird auf S. 78ff. näher erläutert.

Die Flügelschlagbahn verläuft — infolge der von hinten-unten nach vorn-oben geneigten Scharnierachse P1/P2 — nicht senkrecht, sondern schräg, von hinten-oben nach vorn-unten. Der Flügelauf- und -aufschlag ist also in Wirklichkeit ein Ab-Vor- und Auf-Zurückschlag. Die Anisopteren zeigen dabei gegenüber den





Abb. 4. Schematische Darstellung der Funktion kleiner, tonischer Muskeln als zugfederartige "Drosselmuskeln" der Antriebs-Heber (linke Hälfte) und -Senker (rechte Hälfte). Querschnitt durch den Thorax auf der Höhe der Tergalbrücke.

Zygopteren und Anisozygopteren (*Epiophlebia*) eine steilere Ausrichtung dieser (festgelegten) "Grund-Schlagbahnebene" (Abb. 28: großer Winkel  $\lambda_1$  in a) und b) gegenüber  $\lambda$  in c); vgl. auch Tannert, 1958, l.c. Abb. 37 und 38). Dementsprechend sind die Thoraxsegmente (und damit auch die Muskeln, Terga etc.) in den beiden Gruppen verschieden stark schräggestellt (in den Abbildungen wurde die schräge Ausrichtung der Segmente in der Regel nicht berücksichtigt).

Die Muskulatur des Flugapparates der Libellen kann (relativ grob) in drei Kategorien unterteilt werden: 1) Die mächtigen Auf- und Abschlagsmuskeln (die "Powermuskeln") *dvm1*, *bas1* und *sub1*, die den Flügel als Ganzes bewegen; man kann sie als die wesentlichen Antriebsmuskeln eines übergeordneten "Flugmotors" ansehen. 2) Muskeln, die zwar auch den Flügelschlag und den Flügel als Ganzes betreffen (weshalb sie ebenfalls dem Flugmotor zuzurechnen sind), aber — da sie erheblich schwächer als die Powermuskeln und wahrscheinlich

tonisch aktiv sind — als "Einstellmuskeln des Flugmotors" betrachtet werden müssen (s. S. 45f.). 3) Muskeln, die in der Größe dazwischen liegen und die eigentlichen Stellmuskeln verkörpern; sie verändern, mehr oder weniger unabhängig vom Antriebssystem, durch Bewegung von untergeordneten Teilsystemen die Anstellung oder die Schlagbahn des Flügels (s. S. 46ff. und S. 57ff.).

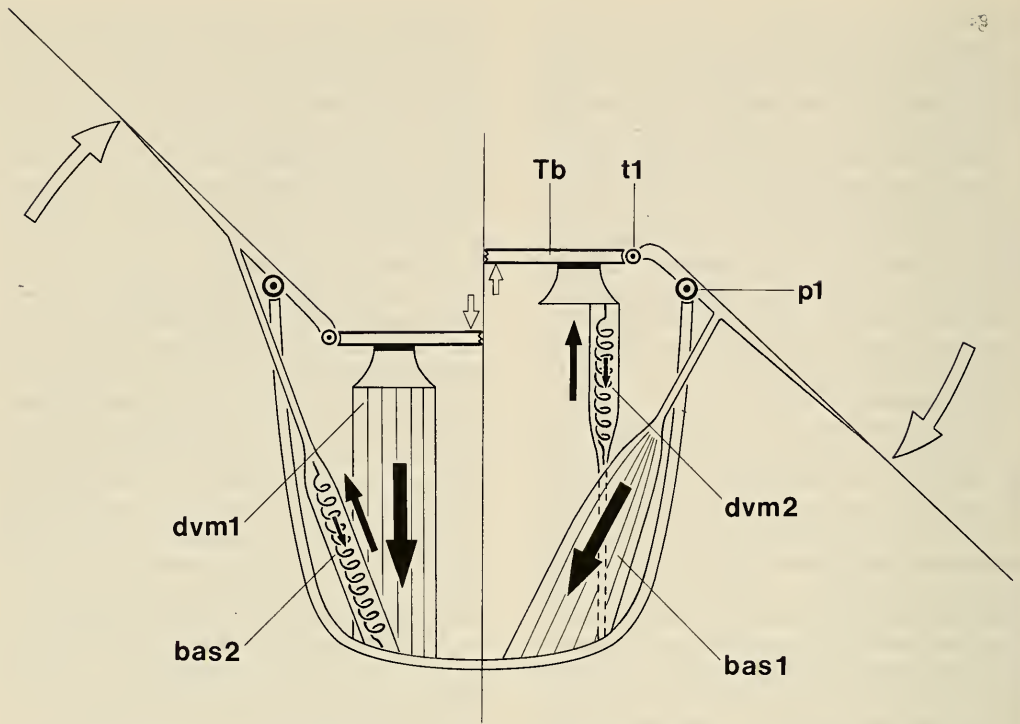
In vielen Fällen ist es allerdings noch fraglich, ob Muskeln tonisch oder phasisch aktiv sind (oder beide Kontraktionsmöglichkeiten besitzen). Meine Versuche, dies durch elektrische Reizung festzustellen, führten nicht immer zu eindeutigen Ergebnissen. Einzelne Muskeln kontrahierten sich auf jeden Einzelreiz hin (*dvm1*, *bas1*, *sub1*, *sub2*, *vca*, *hca*, *fa*; auch beim *dlm* war dies in einem Experiment der Fall) — sie sind demnach als phasisch einzuschätzen. Andere Muskeln (*bas2*, *sub3*) sprachen auf Einzelreize nicht an und zeigten erst bei höherer Reizfrequenz eine Kontraktion; dies wurde als Anzeichen einer tonischen Aktivität angesehen.



Abb. 5. Schema des bistabilen Schlagmechanismus; Abschlag a → c, Aufschlag d → f. Querschnitte durch den Thorax auf der Höhe der Tergalbrücke. Die Pleuralleiste wird in der ersten Hälfte beider Schlagphasen (bis b bzw. e) seitwärts ausgelenkt; ihre Rückstellkraft ist durch den Tergopleuralmuskel (tp), der bis zur Schlagmitte gedehnt wird, einstellbar. Da eine gegenphasige Bewegung des rechten und linken Flügels unwahrscheinlich ist, muß der Flügel der anderen Körperseite (mit gleicher Bewegungsrichtung) jeweils gedanklich ergänzt werden.

Hier müssen weitere Untersuchungen, v.a. aber elektrophysiologische Ableit-Experimente an fliegenden Tieren, angeschlossen werden.

#### Einstellmöglichkeiten des Flugmotors

Zwei kleine Muskeln, der 2. Basalarmuskel und der 2. Dorsoventralsmuskel (bas2, dvm2; Abb. 2) greifen mit sehr langen Sehnen (der eigentliche, die Muskelfasern enthaltende Teil ist also nur kurz) so am Flügel bzw. Tergum an, daß sie — wie die großen, dicht bei ihnen liegenden Muskeln bas1 bzw. dvm1 — als Ab- bzw. Aufschlagsmuskeln des Flugmotors betrachtet werden könnten. Der Größenunterschied zu den phasischen Antriebsmuskeln bas1 und dvm1 ist jedoch so gravierend, daß eine phasische Kontraktion (bas2 beim Abschlag, dvm2 beim Aufschlag) als relativ wirkungslos

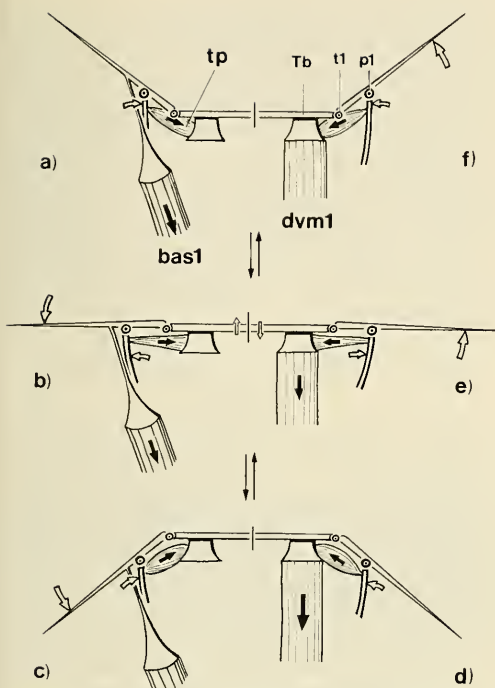
angesehen werden muß (darauf wies bereits Hatch, 1966, hin). Nimmt man dagegen eine tonische Kontraktion an!), so ergibt sich, daß der bas2 der Aufschlagswirkung des dvm1, der dvm2 dagegen der Abschlagswirkung des bas1 entgegenwirkt (Abb. 4)<sup>2)</sup>. Damit könnten Flügelgeschwindigkeit und Amplitude beim Auf- und Abschlag getrennt eingestellt werden. Die Muskeln wären jetzt als Zugfedern (mit variabler Federkonstante!) jeweils in die Phase des antagonistischen Antriebsmuskels eingeschaltet; sie würden nur in dieser Phase "belastet", in der anderen dagegen "entlastet". (Dieser Gesichtspunkt wurde von Hatch, 1966 — und auch von Neville, 1960 — übersehen; s. dazu auch S. 92f. und S. 111ff. Zu dem funktionell ähnlichen Muskel sub3 vgl. S. 56.)

Während die Muskeln bas2 und dvm2 jeweils nur in eine Schlagphase (drosselnd) eingreifen, kann ein weiterer, wohl ebenfalls tonischer Muskel, der Tergopleuralmuskel (tp, Abb. 2), den Flügelauf- und -abschlag (in symmetrischer Weise) beeinflussen. Der Muskel vermag die Pleuralleiste nach innen zu ziehen, was im Mesothorax zu einer gegenseitigen Annäherung der Ränder eines dorsalen Membranspaltes, der sich zwischen den Episterna der beiden Körperseiten befindet, führt. Drückt man bei einem frischtoten Tier die Pleuren nach medial, so schließt sich der Spalt ebenfalls, und die Flügel werden entweder auf- oder abgeschlagen — je nach ihrer Ausgangsstellung diesseits oder jenseits der Schlagmitte. Da die starre Tb für einen konstanten Abstand zwischen den Gelenken t1 der beiden Körperseiten sorgt, und der Abstand t1-p1 ebenfalls konstant ist, schwingen die Pleuren demnach beim natürlichen Auf- und Abschlag zunächst seitwärts (entgegengesetzt zur Krafrichtung des tp: Öffnen des Membranspaltes) und dann, mit der tp-Kraft, nach innen zurück (Schließen des Spaltes). Das bedeutet, daß der tp (beim Flug tonisch kontrahiert) jeweils nur in der zweiten Schlagphasenhälfte als

1) Am bas2 durchgeführte elektrische Reizversuche deuten darauf hin, daß zumindest dieser Muskel beim Flug tonisch kontrahiert ist (vgl. S. 44).

2) Ein weiterer dünner Muskel, der Tergocoxalmuskel (hier nicht abgebildet; dvm5 bzw. tc in der Tabelle 1, S. 112f.) könnte theoretisch eine ähnliche Funktion wie der dvm2 haben. Da er jedoch an die Coxa zieht, ist er wohl eher als Beinbeweger zu betrachten. Im Gegensatz zum dvm2 ist die Sehne des dvm5 kurz, der eigentliche Muskelteil dagegen lang.

Synergist der Antriebsmuskeln der betreffenden Schlagphase wirksam ist; in der ersten Hälfte beider Schlagphasen, in der die Pleuralwände nach lateral bewegt werden, ist er dagegen ihr Antagonist (vgl. Abb. 5). Der Tergopleuralmuskel der Libellen ist damit als Einstellmuskel eines bistabilen Mechanismus ("Klickmechanismus") zu betrachten, ähnlich wie der Pleurosternalmuskel oder der Tergopleuralmuskel<sup>1)</sup> der Fliegen (vgl. Boettiger & Furshpan, 1952; Nachtigall & Wilson, 1967; Heide, 1971; Pfau, 1973; Pfau et al., 1977). Dieser Mechanismus bewirkt, daß die Antriebskräfte des Flugmotors beim Auf- und Abschlag unterschiedlich auf die beiden Schlagphasen-Hälften verteilt werden: sie werden anfangs (in der ersten Hälfte) teilweise zur Überwindung der (durch den tp veränderlichen) "Pleurfeder" eingesetzt, während ihnen in der zweiten Schlagphasen-Hälfte (jenseits des instabilen Klickpunktes; Abb. 5b, e) die Federkraft des zurückschwingenden Pleurum wieder hinzugefügt wird (die zunächst "abgezweigten" Teilkkräfte gehen dem Flügelschlag also nicht verloren). Eine Bedeutung des bistabilen Schlagmechanismus könnte daher darin liegen, daß die Antriebsmuskeln (die sich im Prinzip nur bis zum Klickpunkt zu kontrahieren brauchen) im isometrischen Bereich arbeiten können. Außerdem könnten Schlagfrequenz und Thorax-Resonanzfrequenz aufeinander abgestimmt werden (entsprechend wie beim Pleurosternalmuskel der Fliegen, vgl. Nachtigall & Wilson, 1967).

Der Flügelschlag kann also — abgesehen von Veränderungen der Kontraktionsstärke und Frequenz der Antriebsmuskeln — durch relativ schwache, tonische Neben- bzw. Verspannmuskeln beeinflusst werden. Die Wirkung der beiden Muskeltypen (bas<sub>2</sub>, dvm 2 — tp) auf den Flügelschlag ist jedoch grundsätzlich verschieden. Durch die Muskeln bas<sub>2</sub> und dvm2 können wohl kleinere Schlagunterschiede zwischen rechtem und linkem Flügel bewirkt (oder ausgeglichen) werden. Bei symmetrischer Arbeit der Antriebsmuskeln sind damit Geschwindigkeits-, Phasen- und Amplitudenunterschiede möglich, die wahrscheinlich bei Steuerbewe-

gungen eine wesentliche Rolle spielen (vgl. auch S. 92f.). Die tp-Muskeln der beiden Körperseiten stellen dagegen die Stärke eines bistabilen Klickmechanismus ein. Dies setzt allerdings eine weitgehend gleichartige (symmetrische) Schlagbewegung der Flügel beider Körperseiten voraus (Abb. 5), woraus geschlossen werden könnte, daß größere Rechts-Links-Unterschiede der Flügelschwingung (bei Wendeaktionen) und ein stärkerer Einsatz des Klickmechanismus (beim schnellen Vorwärtsflug?) nicht zu vereinbaren sind.

#### DREHBEWEGUNGEN DES FLÜGELS UM DIE LÄNGSACHSE

Die Bewegungsrichtungen des Flügels bei Drehung um die Längsachse sind durch die Begriffe Pronation und Supination gekennzeichnet: Bei einer Pronation bewegt sich die Flügelvorderkante nach unten und die Hinterkante nach oben; dabei beschreibt die Hinterkante, infolge der (bei Insekten wohl in der Regel) weit vorn liegenden Drehachse, einen größeren Kreisbogen als die Vorderkante. Bei der Supination wird die Vorderkante entsprechend nach oben, die Hinterkante nach unten bewegt.

Pronation und Supination werden beim Libellenflügel durch zahlreiche Gelenke und gelenkähnliche Stellen in der Flügelbasis und im Flügel ermöglicht. Dabei kann der gesamte Drehspielraum in zwei Unterbereiche, "Abschlagsdrehbereich" und "Aufschlagsdrehbereich", unterteilt werden (Abb. 6). Diese beiden Bereiche müssen getrennt betrachtet werden, da ihnen eine unterschiedliche Mechanik zugrunde liegt. Die Bezeichnungen für sie sind jedoch insofern nicht ganz treffend, als die Drehbereiche beim Flug den beiden Schlagphasen nicht genau "entsprechen" müssen. So kann der Flügel z.B. schon vor der oberen Schlagwende (also noch in der Aufschlagsphase) in den Abschlagsdrehbereich hineinbewegt werden (vgl. S. 97f.). Die extremen Flügelanstellungen der beiden Bereiche ( $p_{\max}$  und  $S_{\max}$ , Abb. 6) werden jedoch sicher nur innerhalb der jeweiligen Schlagphase erreicht.

Die beiden Drehbereiche grenzen in einer mittleren Anstellung ( $0^\circ$ , s. Abb. 6) aneinander. An dieser Stelle sind sie (von beiden Seiten her) durch Anschläge mechanisch getrennt. Wird der Flügel von der mittleren Anstellung aus proniert oder supiniert, so führen beide Bewegungen (also die Pronation im Abschlagsdrehbereich und die Supination im Aufschlagsdrehbereich) zu einer Verwindung des Flügels

<sup>1)</sup> Dieser letztere Muskel, genauer der Pleuralleiste-Subtegula-Muskel (dessen medialer Ursprung bei verschiedenen Dipteren von der Subtegula zum Tergum-Seitenrand verlagert sein kann; vgl. Mickoleit, 1969, l.c. S. 160), ist wahrscheinlich — da der Sklerit vTS der Subtegula entspricht (vgl. S. 87f.) — dem tp der Odonaten homolog.



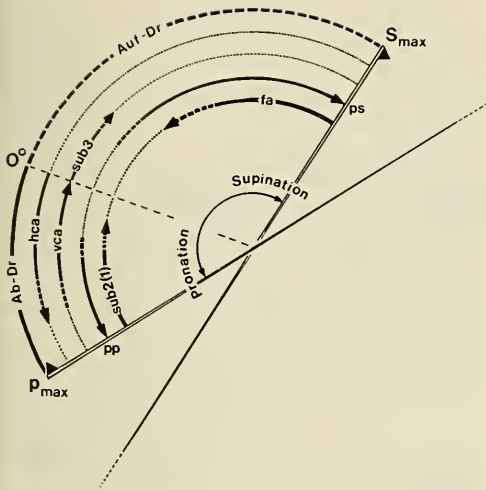

depunktmuskeln“, die den Flügel am Auf/Ab-schlags- bzw. Ab/Aufschlagsumkehrpunkt drehen, und 2) “Einstellmuskeln” der Flügelanstellung, die die Flügelanstellung innerhalb der eigentlichen Ab- oder Aufschlagsphase beeinflussen.

Die Drehbewegungen des Flügels um die Längsachse werden im folgenden “chronologisch”, zunächst für den Flügel-Abschlag (Abschlagsdrehbereich) und dann für den Aufschlag (Aufschlagsdrehbereich), behandelt; dabei soll jeweils zuerst auf die zugrundeliegende Mechanik des Drehbereichs und dann auf die in ihm wirkenden Kräfte eingegangen werden.

### Abschlagsdrehbereich

Mechanik. — Am Ende des Aufschlags geht die supinatorische Aufschlagsverwindung mit dem Ausschwingen des Flügels (bzw. seiner Verlangsamung durch die beginnende Kontraktion der Abschlagsmuskeln) zurück: passiver, v.a. durch elastische Rückstellkräfte bedingter Teil der Pronation der oberen Schlagwende im Aufschlagsdrehbereich (vgl. S. 53ff.). Der Flügel vollzieht jetzt eine darüber hinausgehende Pronationsdrehung in den Abschlagsdrehbereich hinein, die mit großer Wahrscheinlichkeit aktiv, durch einen phasischen Muskel, verursacht wird (vgl. S. 50). Obwohl beide Vorgänge pronatorisch sind, müssen sie aufgrund der unterschiedlichen Mechanik der beiden Drehbereiche getrennt behandelt werden (s. oben).

Im Abschlagsdrehbereich ist fast die gesamte Flügelbasis — die ganze Radioanalplatte (und mit ihr die gesamte Flügelspreite) sowie ein Teil der Costalplatte — an der Drehbewegung beteiligt (im Gegensatz zum Aufschlagsdrehbereich, in dem nur ein kaudaler Bereich der RAP bewegt wird und die übrige Flügelbasis in Ruhe bleibt). Nur die mittlere und die vordere Costalplatte (mCP, vCP; Abb. 3) sind nicht (oder nur geringfügig, wie im Falle der vCP<sup>1)</sup>) betroffen; sie bilden damit — im Verein mit dem pleuralen, vorderen Gelenkkopf (vGK), auf dem sie aufliegen — das für die Bewegungen im Abschlagsdrehbereich wesentliche Widerlager (dunkel hervorgehoben in Abb. 8, 9a, b und 14). Der bewegte Teil des Flügels soll hier, zur Ver-

<sup>1)</sup> Die vCP steht proximal mit der hCP in Verbindung und wird bei der Abbiegung der hCP (s.S. 49) geringfügig verformt und um t1 gedreht. Diese Bewegung wurde hier — da kein Einfluß auf andere Bewegungssysteme ersichtlich ist — vernachlässigt.

Abb. 6. Flügeldrehbereiche und -kräfte (qualitatives Schema). Querschnitte durch den Flügel — das schwarze Dreieck kennzeichnet die Flügel-Vorderkante und -Oberseite. Ab-Dr Abschlagsdrehbereich, Auf-Dr Aufschlagsdrehbereich (bei 0° durch Anschläge gegeneinander abgegrenzt); pp passiv-pronierende, ps passiv-supinierende Kräfte.

(allerdings auf ganz verschiedene und nicht symmetrische Weise); dabei ist es gleichgültig, ob die Drehungen durch Muskelkräfte (aktiv, von proximal aus) oder durch Luftkräfte (passiv, von distal aus) bewirkt werden. Eine gleichzeitige Aktivität von Muskeln, die den Flügel entgegengesetzt verwinden, kann als unwahrscheinlich angesehen werden (jedenfalls innerhalb der Schlagphasen). Die den Flügel gleichsinnig drehenden Muskeln der beiden Drehbereiche können andererseits aufgrund der mechanischen Trennung nur “hintereinandergeschaltet” wirksam werden; z.B. kann der Pronator des Abschlagsdrehbereichs erst dann optimal “greifen”, wenn die supinatorische Verwindung im Aufschlagsdrehbereich vorher ganz rückgängig gemacht ist — der Einflußbereich des “rückdrehenden” Pronators im Aufschlagsdrehbereich endet dabei beim 0°-Anschlag. So kann über die Grenze der Drehbereiche hinweg strenggenommen nicht von Synergisten oder Antagonisten gesprochen werden, selbst wenn der Flügel im Prinzip im gleichen oder entgegengesetzten Sinn gedreht wird. Die verschiedenen Muskeln sind demnach funktionell sowohl nach ihrem Drehbereich als auch nach ihrer Drehrichtung zu charakterisieren. Darüber hinaus können anscheinend zwei Haupttypen von Drehmuskeln unterschieden werden: 1) “Wen-



Abb. 7. Schematische Darstellung einiger Teile der Flügelbasis sowie der Drehachsen des Abschlagsdrehbereichs. Blick von medial-dorsal auf die beiden Flügelbasisplatten, die auf der Höhe des Pleurum (und z.T. auch weiter distal) angeschnitten wurden; Membran weggelassen, Sklerite der Flügelunterseite schraffiert. Die phCP wurde einwandig (massiv) gezeichnet — sie stellt in Wirklichkeit eine doppelwandige Ausstülpung der Dorsal-seite dar, die kaudal in die Membran zwischen CP und RAP übergeht. Nur die Pronation wurde durch Bewegungspfeile (an den Achsen P2/C4, C1, E1 und am Gelenk c3) verdeutlicht; die Pfeile an der Achse P1/P2 (der durch die Gelenke p1 und p2 gebildeten Scharnier-Schlagachse — p1 stellt dabei für sich ein Scharniergelenk dar) symbolisieren den Flügelschlag.

einfachung der Beschreibung, als "Verstellflügel"<sup>1)</sup> bezeichnet werden.

<sup>1)</sup> Der Begriff wurde von Pfau & Honomichl (1979) auch für den bei Pronation bzw. Supination bewegten Teil des Lamellicornier-Flügels verwandt, soll aber, als reine Bezeichnung eines Funktionsteils, keine Homologievorstellung ausdrücken.

Drei Gelenke, die der Verstellflügel zu den (nicht-mitbewegten) Widerlager-Teilen ausbildet, bestimmen zwei Haupt-Drehachsen des Abschlagsdrehbereichs (Abb. 7 und 9a, b): 1) Die Hauptachse C1 zieht durch ein ungefähr in Flügellängsrichtung ausgerichtetes Biege-gelenk zwischen der mCP und phCP (c1, Abb. 3

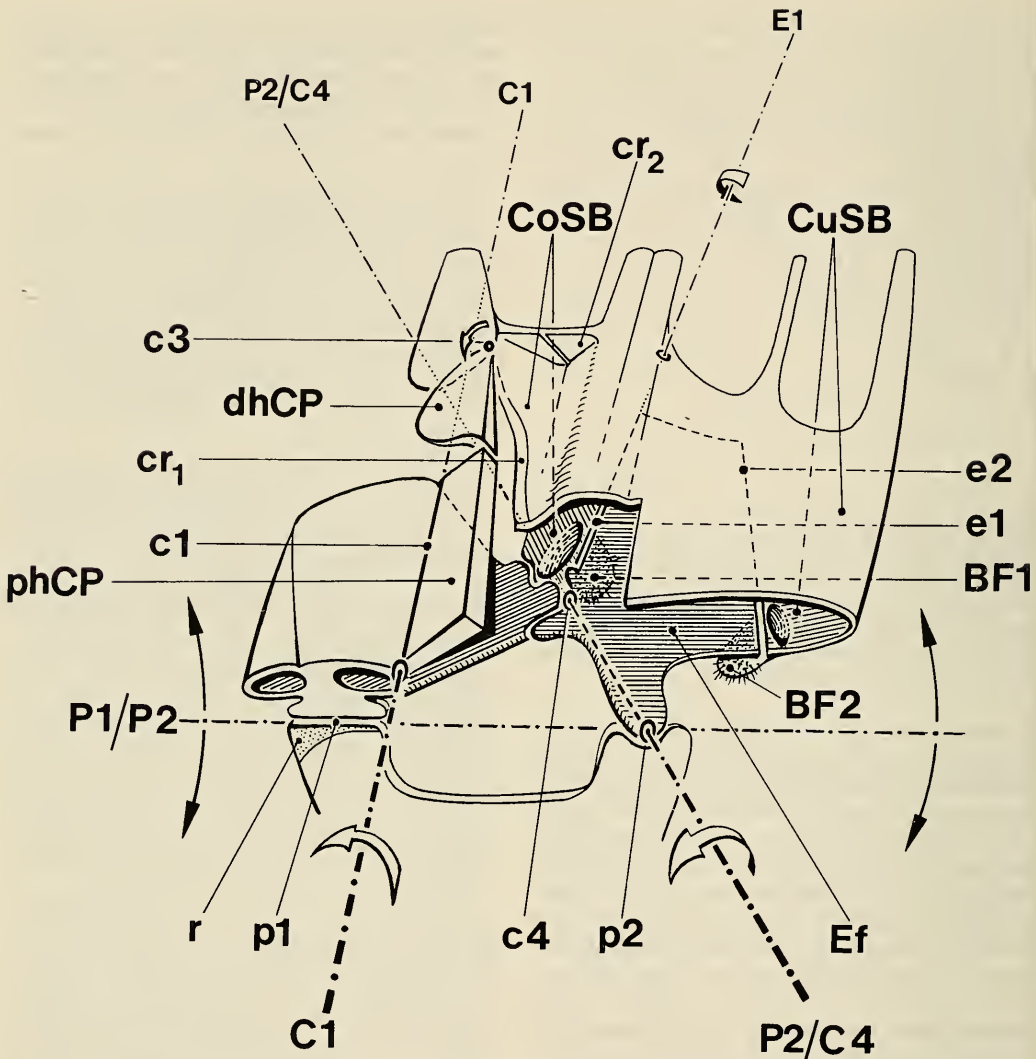
und 7); diese Achse kann (in Annäherung; vgl. S. 50) als eine Scharnierachse aufgefaßt werden. 2) Die Hauptachse P2/C4 wird durch zwei Gelenkpunkte, die zusammen ein Scharniergelenk bilden, bestimmt: durch das pleurale Flügelgelenk p2 zwischen Fulcrum und RAP-Unterseite (Abb. 7; das Gelenk ist gleichzeitig an der Bildung der Auf-Abschlags-Scharnierachse P1/P2 beteiligt — vgl. S. 43f.) und das weiter distal liegende (morphologisch komplizierte) Gelenk c4 zwischen dem ventralen Kaudalfortsatz der mittleren Costalplatte und der Unterseite der RAP (vgl. S. 41; Abb. 3, 7 und 10; zu diesem Gelenk s. auch S. 57ff.). Die beiden Hauptdrehachsen kreuzen sich nach ihrem Austritt aus der Flügelbasis im Raum, ohne sich in einem Punkt zu schneiden.

An der Bewegung des Verstellflügels ist, wie schon dargestellt wurde, proximal nur der hintere Teil der Costalplatte (die hCP) beteiligt, die Radioanalplatte dagegen als Ganzes. Von distal betrachtet spaltet die Flügelfläche demnach bei c3 (dem distalen Gelenk zwischen der CP und RAP bzw. CoSB; vgl. S. 42 und Abb. 3 und 7) nach vorn einen Basisteil (die hCP) ab und geht hinten als Ganzes in die RAP über. Beide Teile bilden weiter proximal die oben beschriebenen Gelenke, die hCP das Gelenk c1 der Flügeloberseite<sup>1)</sup>, die RAP das Doppelgelenk p2/c4 der Unterseite. Wird der Verstellflügel um die Längsachse gedreht, so wird er zu gleicher Zeit in beiden basalen Gelenken bewegt; da beides Scharniergelenke mit unterschiedlicher Achsenausrichtung sind, wird er proximal unter Spannung gesetzt und verformt (was weiter distal wiederum zu einer Verwindung der Flügelspreite führt; s. unten).

Die Ursache für die Verspannung der Flügelbasis kann man sich leicht durch ein Experiment verdeutlichen: Trennt man die RAP von der hCP ab (durch einen Schnitt durch das Gelenk c3) und bewegt die hCP für sich (im Gelenk c1) — und anschließend die RAP für sich (im Gelenk p2/c4) — so beschreibt der Punkt c3 jeweils eine unterschiedliche Raumbahn; im einen Fall um die Achse C1, im anderen um P2/C4. Beim intakten Flügel existiert eine solche unabhängige Beweglichkeit der Teile natürlich nicht und der Verstellflügel gerät bei einer Drehbewegung zwangsläufig unter Spannung.

Die aus der Verspannung resultierende Verformung läuft in verschiedenen weiteren Gelenken und gelenkartigen Stellen ab. Abgesehen

vom tergalen Gelenk t2 (in dem sich die RAP gegenüber dem Tergum dreht) und weiter distal im Flügel liegenden Gelenken (s. unten), spielen v.a. zwei Gelenkstellen in der Flügelbasis eine wesentliche Rolle: 1) das schon erwähnte Gelenk c3, die Stelle, an der die Flügelfläche das vordere Basiselement hCP "abspaltet"; 2) das Gelenk e1 zwischen Epifulcrum und Costalsektor, ein vertieft liegendes und daher von außen schwer erkennbares Scharniergelenk der RAP-Ventralseite (vgl. S. 42). Die dem Gelenk e1 ungefähr gegenüberliegende Biegezone in der dorsalen Wandung der RAP (vgl. S. 42) wurde hier nicht gesondert benannt, da sie zusammen mit dem Gelenk e1 funktionell als ein Gelenk in der RAP aufgefaßt werden kann; Gelenk und Biegezone bilden gemeinsam das Basisgelenk des CoS, wobei das gut definierte Scharniergelenk e1 für die Bewegungen des CoS maßgeblich ist.

Eine pronatorische Drehbewegung des Flügels im Abschlagsdrehbereich (Abb. 7; Abb. 9a → b) kann jetzt genauer beschrieben werden — sie stellt eine gleichzeitige Bewegung der Flügelbasis in allen vier aufgeführten Gelenken dar: Die hCP wird um C1 nach dorsal gebogen (vgl. auch S. 50); die RAP bewegt sich zugleich um P2/C4, ihr Vorderrand geht nach unten; die RAP wird unter Spannung gesetzt, wobei ihr vorderer Teil, die CoSB, um die Achse E1 abgebogen wird; hCP und RAP werden im Gelenk c3 gegeneinander verdreht, was äußerlich daran zu erkennen ist, daß sich die vordere Costakante vom Vorderrand der dhCP entfernt (Vergrößerung des durch Costa und dhCP gebildeten Winkels; vgl. Abb. 14 c → a). Der Gelenkpunkt c3 wird auf einer aus allen Bewegungskomponenten resultierenden Bahn bewegt.

Für die Bewegung des Costalsektors ist, wie schon erwähnt wurde, die Ausrichtung der durch das Gelenk e1 festgelegten Costalsektor/Epifulcrum-Scharnierachse E1 bestimmend. Diese Achse steht schräg zum Flügel und verläuft (bei horizontal gestelltem Flügel) von innen-vorn-unten nach außen-hinten-oben. Der Costalsektor (zusammen mit den am Nodus fest angekoppelten distalen Vorderrandern; vgl. S. 54 und Abb. 8) wird daher bei einer Pronation nach ventral-kaudal, relativ zur in Ruhe bleibenden ("eingespannten") Basis des CuS, bewegt. Diese Bewegung (die geringfügig ist und daher ganz proximal, bei e1, kaum auffällt) führt in der basalen Flügelhälfte dazu, daß die Zwischenräume zwischen den vorderen Längs-

<sup>1)</sup> Die phCP ist eine Vorwölbung der Flügeloberseite.



adern zusammengedrückt und verschmälert werden (wobei Gelenkstellen zwischen den Quer- und Längsadern im Cubitalsektor und an der Grenze zum Costalsektor eine Rolle spielen; vgl. Abb. 8) und bewirkt in diesem Bereich außerdem eine Verwölbung des Flügelprofils nach dorsal. Jenseits des Nodus wird dagegen mehr und mehr die mit dem CoS und den (distalen) Flügelvorderrand-Adern verbundene gesamte Spreite erfaßt und gegenüber dem basalen (stabileren, proximal eingespannten) Bereich des CuS verdreht (Verwindung der Flügelspreite!).

Demnach findet bei einer Pronationsbewegung im Abschlagsdrehbereich eine pronatorische Drehung des ganzen Verstellflügels (um C1 + P2/C4) statt, der eine (ebenfalls pronatorische!) Verwindungsbewegung überlagert ist — der Flügel wird dadurch distal stärker proniert als proximal. "Pronation als Ganzes" und "pronatorische Verwindung" gehen aufgrund des Zusammenspiels aller Gelenke zwangsläufig stets miteinander einher. (Zur aerodynamischen Bedeutung der Verwindung vgl. S. 96f.) Eine "eigentliche Drehachse" des Abschlagsdrehbereichs konnte daher in den Abb. 7 und 9 nicht eingezeichnet werden — sie entspricht weder C1 noch P2/C4, sondern verläuft (als "immaterielle" Achse) zwischen ihnen im Raum. Da die hintere Costalplatte in Wirklichkeit über eine scharnierartige Biegezone (und kein echtes Scharniergelenk, wie hier zunächst vereinfachend beschrieben) mit der mittleren Costalplatte verbunden ist, ist die Achse C1 — und damit auch die im Raum verlaufende "eigentliche Drehachse" des Flügels — darüber hinaus nicht ganz festgelegt (s. Abb. 9a, b). Alle beschriebenen Achsen des Abschlagsdrehbereichs (C1, P2/C4, E1) verändern beim Flügelschlag (also bei der Bewegung des ganzen Flügels um die Schlagachse P1/P2; Abb. 7) ihre Ausrichtung zum Körper. In Bezug auf den Flügel sind sie jedoch entweder als stabil zu betrachten (P2/C4) oder machen eine dem Ablauf der Drehbewegung (nicht dem Flügelschlag-Ablauf!) fest zugeordnete Achsenverstellung durch (C1, E1; vgl. Abb. 9), so daß die Drehbewegungen also in einem vom Antriebssystem ("Motor") mechanisch weitgehend unabhängigen System ablaufen (vgl. unten und S. 91ff.).

Der Abschlagsdrehbereich ist relativ klein; er ist zum pronatorischen Extrem hin ( $p_{\max}$ , Abb. 6) wohl v.a. durch die (infolge der Verspannung und Verwölbung der Flügelfläche) zunehmend

erschwerter Verwindung begrenzt. Dreht man den Flügel von dort (supinatorisch) zurück (Abb. 7, Pfeile jedoch in umgekehrter Richtung; Abb. 9b → a), so erreicht der Drehbereich bei 0° einen Anschlag, und zwar vor allem dadurch, daß die Costa bei c3 von unten auf die dhCP stößt (Abb. 14a → c).

Kräfte. — Die Flügelfläche, die sich nach proximal in die hCP und RAP gewissermaßen "aufspaltet", besitzt mehrere Hebel für pronatorische und supinatorische Muskeln (aktive Kräfte); die distale Flügelfläche selbst bildet den wesentlichen Hebel für die beim Flug angreifenden, die Flügelanstellung von außen beeinflussenden Luftkräfte (passive Kräfte).

Nur ein Muskel, der hintere Coxoalarmuskel hca, greift an einem pronatorischen Hebel, dem nach vorn-proximal über die P2/C4-Achse vorragenden Randteil der RAP an (genauer Ansatz s. S. 39f.; Abb. 2 und 3). Der Muskel wird daher hier als der wesentliche Pronationsmuskel der Auf-Abschlagswende angesehen (vgl. auch S. 97f.; Abb. 6 und 9a, b) — infolge seines Hebels zur Schlagachse besitzt er außerdem eine Flügelheber-Funktion (vgl. S. 91f.).

Der 1. Basalarmuskel bas1 kann dagegen (im Gegensatz zu bisherigen Auffassungen) als ein reiner Senker angesehen werden, da er an der mittleren Costalplatte (bei  $x_1$ , Abb. 3 und 9a), also außerhalb der Verstellflügels (am Widerlager!) angreift. Die von einigen Autoren postulierte unabhängige Bewegungsmöglichkeit der beiden Flügelbasisplatten CP und RAP um die Schlagachse, die zur Erklärung einer Pronationsfunktion des bas1 herangezogen wurde (vgl. Tabelle 1, S. 112ff.), ist in Wirklichkeit nicht vorhanden: Da die CP an zwei Stellen (dorsal bei c3, ventral bei c4; vgl. auch S. 58) mit der RAP in Kontakt steht, kann sie nicht unabhängig von der RAP um P1/P2 bewegt und der Flügel damit auch nicht (durch eine Abschlagsbewegung der CP) proniert werden. Die CP nimmt die RAP bei einer Schlagbewegung stets einfach mit (wie auch umgekehrt die RAP die CP), ohne sie dabei um eine Längsachse zu kippen. Erst dadurch ist die im Gegensatz zu älteren Anschauungen vorliegende funktionelle Trennung der Flugmotor- und Flügelstell-Mechanik gewährleistet (vgl. auch S. 92f. und S. 112ff.)!

Der 2. Subalarmuskel sub2, der kaudal von P2/C4 an der RAP ansetzt, vermag den Flügel zu supinieren — im Unterschied zum sub3 (vgl.

S. 56) jedoch höchstens bis zur  $0^\circ$ -Anstellung, der Grenze des Abschlagsdrehbereichs zum Aufschlagsdrehbereich (Abb. 9b  $\rightarrow$  a). Damit könnte der sub2 als ein Antagonist des hca angesehen werden. Wahrscheinlich steht der Muskel jedoch beim Abschlag (nach der hca-Kontraktion) einer anderen Kraft antagonistisch gegenüber, so daß seine Funktion nicht (zumindest nicht allein) in einer Einstellung der hca-Kraft zu sehen ist. Beim Abschlag kommen nämlich wesentliche passive Kräfte ins Spiel: In dieser Schlagphase wird die Flügelunterseite von der Luft angeströmt (Abb. 26a). Da die Flügeldrehachse des Abschlagsdrehbereichs vor der Flügelmitte (zwischen C1 und P2/C4; s. S. 50) liegt, und der größere Hebel sich demnach kaudal davon befindet, wird der Flügel beim Abschlag (nach der Pronation durch den hca) wie eine Windfahne passiv pronatorisch weiter gedreht. Der 2. Subalarmmuskel kann nun die Flügelanstellung — gegen die pronierenden Luftkräfte — beim Abschlag so verändern, daß der aerodynamische Anstellwinkel vergrößert (der geometrische Anstellwinkel dagegen verkleinert) wird. Der Muskel verhindert damit, daß der Flügel im Extrem tangential und ohne Luftkraftezeugung angeströmt wird; er bewirkt, über die Vergrößerung des aerodynamischen Anstellwinkels, eine Vergrößerung der erzeugten Luftkraft (vgl. Abb. 26a und S. 93ff.). Da der 2. Subalarmmuskel lateral von der Schlagachse an der RAP angreift, wird der Flügel gleichzeitig mit größerer Kraft abgeschlagen (zur Bedeutung dieser Doppelfunktion vgl. auch S. 92ff.).

Auch der 1. Subalarmmuskel sub1, ein Hauptantriebsmuskel des Flügelschlags (Ansatz am Epifulcrum bei  $x_2$ , Abb. 3 und 9a), besitzt einen supinatorischen Hebelarm zu Drehachse des Abschlagsdrehbereichs; er ist jedoch, verglichen mit dem Hebel des sub2, sehr klein. Da zu erwarten ist, daß bei einer stärkeren Kontraktion des sub1 mit der erhöhten Geschwindigkeit des Flügels auch die Geschwindigkeit der anströmenden Luft vergrößert wird, und die passive Pronation dadurch ebenfalls zunimmt, ist nicht sicher, daß die supinatorische Nebenfunktion des Muskels überhaupt äußerlich in Erscheinung tritt (Abb. 26a). Neville (1960) sprach dem sub1, nach Ausschaltexperimenten, eine Drehwirkung ab; er ging allerdings von einer anderen Flügelmechanik aus und übersah auch die durch die passive Pronation bedingte Täuschungsmöglichkeit (vgl. Tabelle 1, S. 112f., und

Anmerkung 15, S. 115). Auf die supinatorische Nebenfunktion des Muskels soll in der Diskussion (S. 92ff.) noch eingegangen werden.

Bei Kontraktion des vorderen Coxoalarmuskels vca wird der nach lateral in den Flügel ragende Fortsatz des Randsklerits (RS), und damit die über eine sehnartige Zwischenmembran (s. Abb. 1a) mit ihm verbundene hintere Costalplatte, nach unten gezogen. Auch dieser Muskel vermag den Flügel demnach zu supinieren (Abb. 9b  $\rightarrow$  a); da er proximal von der Schlagachse P1/P2 ansetzt, wirkt er gleichzeitig Flügelaufschlagend. Der Zeitpunkt der vca-Kontraktion kann vorerst nur erschlossen werden: Beim Abschlag eingesetzt, würde der Muskel die Flügelschwindigkeit vermindern und den Flügel gleichzeitig supinieren. Diese Funktionskombination erscheint für eine günstige Beeinflussung der Luftkraftezeugung innerhalb der Abschlagsphase (im Gegensatz zur Abschlags- + Supinationswirkung der sub1 und sub2 — vgl. Diskussion S. 92ff.) nicht geeignet. Der Muskel vermag den Flügel andererseits nur im Abschlagsdrehbereich zu supinieren, nicht dagegen im Aufschlagsdrehbereich. Das macht auch einen Einsatz während des Aufschlags unwahrscheinlich. Da die supinatorische Verwindung des aufschlagenden Flügels (vgl. S. 53ff.) erst dann beginnen kann, wenn die pronatorische Verwindung des abschlagenden Flügels bis zum Anschlag rückgängig gemacht ist, bleibt als möglicher günstiger Wirkungsort das Ende des Abschlags bzw. der Beginn des Aufschlags (der untere Schlagumkehrpunkt)<sup>1)</sup>. In diesem Fall bestünde der Vorteil, daß der vca — der (im Gegensatz zum sub2) infolge seines Aufschlag-Hebelarms bis zum Abschlagsende gedehnt wird — im isometrischen Bereich arbeiten könnte; er wäre zu einer besonders effektiven (und wahrscheinlich bis zum Anschlag des Drehbereichs bei  $0^\circ$  reichenden) Supination in der Lage. Je nach Kontraktions-Zeitpunkt und -Dauer würde der Flügel am Abschlagsende abgebremst und supiniert und/oder zu Beginn des Aufschlags supiniert und beschleunigt (Einleitung bzw. Fortführung der Schlagumkehrbewegung). Auf eine mögliche zusätzliche Funktion des Muskels, die mit der hier postulierten

<sup>1)</sup> Auch Beobachtungen von Neville (1960), die allerdings anders interpretiert wurden (vgl. S. 99 f.), deuten auf eine phasische Kontraktion des Muskels am unteren Schlagumkehrpunkt hin.



Abb. 8. Funktionelle Gliederung des Odonaten-Flügels (vgl. Abb. 9). Die CP (bis auf die dhCP schwarz) ist im hinteren Bereich (phCP) als "Spangengerüst" (durchsichtig) dargestellt; die RAP wurde dorsal größtenteils entfernt, um die Teile der Flügelunterseite und das Pleurum zu zeigen. Die Wandungen der CoS- und CuS-Unterseite (nur proximal sichtbar) wurden jeweils dichter punktiert als die der Oberseiten. IR<sub>3</sub>, R<sub>4+5</sub>, s. S. 110f.



„Kontraktion zwischen Ab- und Aufschlagsphase“ in Übereinstimmung steht, soll auf S. 60f. noch eingegangen werden.

#### Aufschlagsdrehbereich

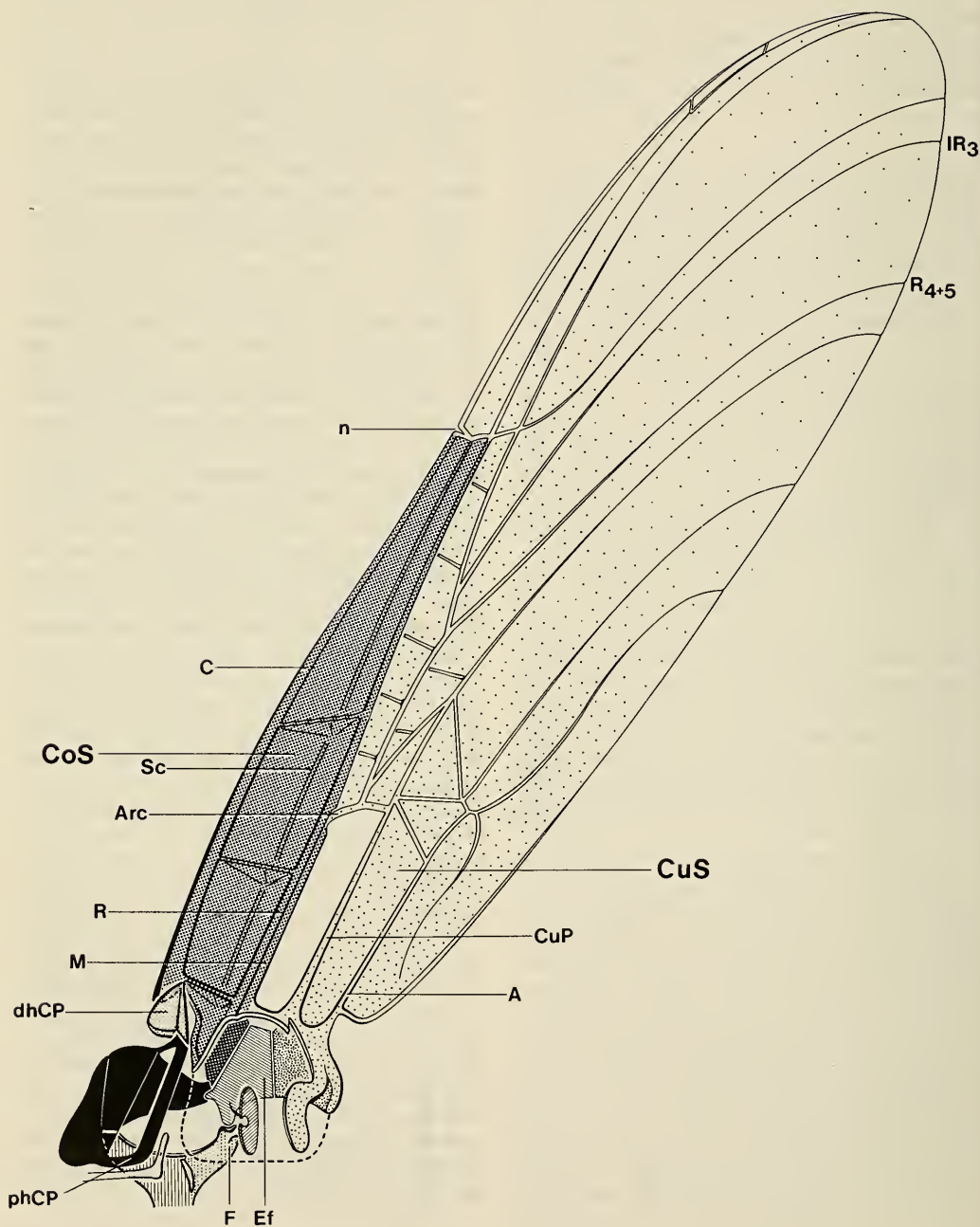
Mechanik. — Am Ende des Abschlages wird der Flügel supiniert — einerseits passiv (Schlagverlangsamung und dadurch verringerte Luftanströmung), andererseits wahrscheinlich aktiv durch den vca (vgl. oben und S. 98). Der Muskel vca wäre dabei sogar in zweierlei Hinsicht ein Supinator: indirekt durch das Abbremsen des Abschlages (Verringerung der passiven Pronation) und direkt durch die Supinationswirkung im Abschlagsdrehbereich. Der Flügel erreicht jetzt (ebenso wie am Ende des Aufschlages) eine zwischen den Drehbereichen liegende Anstellung ( $0^\circ$ , Abb. 6). Während des folgenden Aufschlages kann er von hier aus nur im Aufschlagsdrehbereich, durch eine Bewegung des Cubitalsektors (CuS) relativ zum Costalsektor, supinatorisch weiter gedreht werden (der Abschlagsdrehbereich befindet sich — und bleibt — an seinem Anschlag). Auch diese Bewegung, die aktiv oder passiv bewirkt werden kann (s. unten), führt zu einer Verwindung des Flügels. Im Gegensatz zur (pronatorischen) Verwindung des Abschlagsdrehbereichs, die mit einer Drehung des gesamten Verstellflügels einhergeht, wird der Flügel im Aufschlagsdrehbereich jedoch nur (supinatorisch) verwunden; proximal ist daran allein die Cubitalsektor-Basis (CuSB), der kaudale Teil der RAP, beteiligt.

Die Cubitalsektor-Basis ist ventral mit dem kaudalen Rand des Epifulcrum über das Gelenk e2 (Abb. 7, 10 und 14) — ein Scharniergelenk, das für die Bewegungen im Aufschlagsdrehbereich als bestimmend angesehen werden kann — verbunden. Dorsal geht der Cubitalsektor über mehrere, komplizierte Biegestellen in die RAP über. Wie im Falle des Costalsektors (S. 42, 49) stehen sich also auch hier ein Scharniergelenk (in der ventralen Wandung der RAP) und eine, in diesem Fall komplexe, Biegezone (in der dorsalen Wand der RAP) gegenüber, die funktionell als ein einziges Basisgelenk des Flügelsektors aufgefaßt werden können. Einzelheiten dazu sollen erst auf S. 54f., im Zusammenhang mit der Wirkungsweise des Muskels fa, beschrieben werden.

Die für die Cubitalsektor-Bewegung maßgebliche Scharnierachse E2 (Abb. 9c, d und 15) ist schräg zum Flügel ausgerichtet — beim horizontal gestellten, in Schlagmitte befindlichen Flügel von innen-unten-hinten nach außen-

oben-vorn. Der Cubitalsektor wird dementsprechend (bei einer Supination) nach ventral-frontal-distal bewegt.

Distal von einer aderfreien Zwischenzone zwischen den Längsadern R + M und CuP steht der Cubitalsektor vorn über die prägnante Arculus-Querader (Arc, Abb. 3 und 8) mit dem Costalsektor in gelenkiger Verbindung. Die an dieser Stelle vom Radius nach kaudal-distal (als Arculus) abbiegende Media-Ader kann nur in einem kurzen Gelenkgebiet (arc, Abb. 3) gegenüber dem Radius bewegt werden; die Media ist an dieser Stelle verschmälert, sie wird weiter proximal wieder dicker und verschmilzt dabei mit dem Radius zu einer Einheit. Distal vom Media-Radius-Gelenk arc tritt der Cubitalsektor über mehrere Gelenke schwächerer Queradern und schließlich über das Nodus-Gelenk (n, Abb. 8) mit dem Costalsektor in Kontakt.

Die CuS-Bewegung um E2 führt — ebenso wie die Bewegung des CoS im Abschlagsdrehbereich um E1 (s. S. 49f.) — zu einer Verformung des Widerlager-bildenden anderen Sektors. Ausschlaggebend ist dabei, daß die Achse der im Flügel vom Arculus bis zum Nodus aneinandergereihten Gelenke, die als ein einziges Scharniergelenk zwischen Cubitalsektor und Costalsektor aufgefaßt werden können, anders ausgerichtet ist als die proximale Drehachse E2 des Cubitalsektors. Eine Bewegung des Cubitalsektors kann sich so nicht als eine einfache Schwenkbewegung gegenüber dem Costalsektor-Widerlager abspielen — sie führt zwangsläufig auch zu einer Verformung des CoS: Der Costalsektor, der proximal als fest eingespannt betrachtet werden kann (seine supinatorische Bewegungsmöglichkeit um E1 ist mit Erreichen des c3-Gelenkanschlages erschöpft — vgl. S. 50), wird im distalen Bereich nach dorsal abgebogen (die Aderstabilität nimmt nach distal ab). Außerdem wird auch der (gegenüber dem CoS weniger stabile) Cubitalsektor selbst verformt: in dem an den Arculus anschließenden (mittleren) Flügelabschnitt wird das Wellblechprofil zwischen den Längsadern verändert — mit fortschreitender supinatorischer Cubitalsektor-Bewegung werden die Winkel des Wellblechs spitzer, d.h. die Aderzwischenräume werden zusammengepreßt.

Im Aufschlagsdrehbereich kommt es demnach bei einer Verwindung, wie im Abschlagsdrehbereich, zu einer Verengung der auf den Arculus distal folgenden Aderzwischenräume, und auch — durch Verformung des Arculus selbst — zu einer Verkleinerung des Abstandes

zwischen den proximal vom Arculus liegenden Adern R + M und CuP. Die Verwindungsvorgänge der beiden Drehbereiche sind jedoch in mehrerer Hinsicht nicht symmetrisch. Dem Abschlagsdrehbereich liegt nicht nur eine völlig unterschiedliche Mechanik zugrunde (vgl. S. 47ff.), die Verwindung ist in diesem Drehbereich außerdem viel geringfügiger als die (supinatorische) Verwindung im Aufschlagsdrehbereich. Diese Asymmetrie wird durch die unterschiedliche Stabilität (und Form) der beiden Sektoren und durch die nicht-symmetrische Ausrichtung von E1 und E2 verstärkt. Weiterhin spielen einzelne Gelenke entweder nur im einen oder nur im anderen Drehbereich eine Rolle: Arculus- und Nodus-Gelenk werden z.B. nur im Aufschlagsdrehbereich eingesetzt (s. unten); ein Gelenk der kaudalen Spitze des Flügeldreiecks (das bisher noch nicht erwähnt wurde) ermöglicht dagegen die nur im Abschlagsdrehbereich auftretende Wölbung des Flügelfilz (s. S. 50).

Bei der Supination im Aufschlagsdrehbereich wird nach distal ein immer größerer Querschnitt des Flügels erfaßt und schließlich die gesamte Fläche bewegt, wobei v.a. der Gelenkeinschnitt des Nodus dem distalen Flügelhauptteil einen Spielraum gegenüber dem CoS gibt. Der geometrische Anstellwinkel ( $\alpha$ , Abb. 26b) wird dadurch zur Flügelspitze hin allmählich größer (vgl. Abb. 27; zur aerodynamischen Bedeutung der Verwindung s. S. 96f.).

Die Verwindbarkeit des Flügels im Aufschlagsdrehbereich ist wohl v.a. durch die zunehmende proximale Verspannung der Spreite limitiert. Wird der Flügel vom supinatorischen Extrem ( $S_{\max}$ ) aus pronatorisch zurückgedreht, so endet der Aufschlagsdrehbereich (wie der Abschlagsdrehbereich) bei  $0^\circ$ ; in diesem Fall v.a. deshalb, weil der Arculus (bei Planlage der beiden Sektoren) am Radius einen Anschlag erreicht. Auch das Nodus-Gelenk läßt eine Cubitalsektor-Bewegung über  $0^\circ$  hinaus nicht zu: der Spalt in der Vorderrandader schließt sich, wobei auch hier ein Anschlag gebildet ist, der ein erneutes Spalt-Öffnen (bei der nun folgenden pronatorischen Verwindung im Abschlagsdrehbereich) verhindert.

Kräfte. — Auch im Aufschlagsdrehbereich kann der geometrische Anstellwinkel des Flügels — in diesem Fall von der Cubitalsektor-Basis (CuSB) aus — aktiv vergrößert oder verkleinert werden. Drei Muskeln setzen an der Cubitalsektor-Basis an (sub2, sub3, fa; Abb. 3), jedoch können nur zwei davon (sub3, fa) als

zum Aufschlagsdrehbereich gehörige Stellmuskeln angesehen werden.

Der Fulcroalarmuskel fa entspringt von einer kurzen Kappensehne, die an der Grenze zwischen Fulcrum und Epifulcrum beweglich aufgehängt ist (Abb. 2, 3 und 8), und zieht, etwa in Körperlängsrichtung, zum kaudalen Ende der RAP. Dort greift der Muskel an der Kutikula der Oberseite der CuSB an. Da die Funktion des fa nur verständlich wird, wenn die skelettmechanischen Verhältnisse parallel dazu genau beschrieben werden, soll das komplizierte dorsale Gelenkgebiet der CuSB im Abschnitt "Kräfte" (und nicht im Abschnitt "Mechanik") behandelt werden.

Die Ansatzfläche des fa stellt ein in die kaudale RAP eingesenktes Gebiet dar, das nach ventral und lateral apodemartig etwas über den Rand der Vertiefung hinaus ins Körperinnere vorragt (Abb. 15). Nach kaudal-dorsal setzt es sich in einem Sklerit fort, der anfangs etwa senkrecht auf der Muskelansatzfläche steht, dann zur Postcubitus- und Analis-Basis hin umbiegt und in diese übergeht. Dieses geschwungene Skleritband, der Cubitalsektor-Hebel (CuSH, Abb. 1a, 3, 8 und 15), verbindet das Ansatzgebiet des Muskels außerdem mit der Unterseite der kaudalen RAP (die weiter vorn das Gelenk e2 zum Epifulcrum ausbildet); die Verbindungsstelle liegt da, wo die Dorsalseite des Flügels an der Basis der Analis in die Ventralseite umschlägt. (Das Flügel-Ligament und die Membranula, die diese Stelle verdecken, wurden in den Abb. 3 und 8 weggelassen.)

Der CuSH grenzt vorn an einen Membranspalt (ms, Abb. 1a, 3 und 15), der proximal von der Stelle ausgeht, wo der CuSH auf das Ansatzgebiet des fa trifft. An dieser Stelle beginnt außerdem eine schmale Zone besonders harter (sich schwarz hervorhebender) Kutikula (z, Abb. 1a, 9c und 15), die sich nach frontal-dorsal-distal erstreckt und an einem in Flügellängsrichtung verlaufenden Falz (f, Abb. 15) gelenkartig endet. Der Falz, der die RAP etwa auf der Höhe des Postcubitus durchzieht, kann als die vordere, dorsale Grenze der CuSB aufgefaßt werden: an dieser Linie "artikuliert" die CuSB (stark vereinfacht ausgedrückt) mit der RAP-Mittenregion, wobei sie v.a. durch die Skleritverstärkung z eine besondere Aufhängung erhält.

Die CuSB wird bei einer supinatorischen Verwindung des Flügels (vgl. S. 53) sowohl ventral (gegenüber dem Epifulcrum) als auch dorsal (gegenüber der vor dem Falz f liegenden



RAP-Mittenregion) bewegt. Auf der Flügelunterseite wird der Winkel zwischen dem am Scharniergelenk e2 aneinandergrenzenden Teilen verkleinert; auf der Oberseite wird das Ansatzgebiet des fa nach hinten(-oben) aus der RAP "herausbewegt" und der Muskel dadurch gedehnt (schematisch dargestellt in Abb. 9c → d, 14c → e und 15). Diese Bewegung des Muskelansatzgebietes verläuft sehr genau in der Richtung der Muskelfasern des fa. Die Biegeelenke der dorsalen CuSB übersetzen demnach die Bewegung des Cubitalsektors um die Scharnierachse E2 in eine in der Muskelzugrichtung verlaufende Bewegung des fa-Ansatzes. Beobachtet man den Fulcroalarmuskel (durch kleine Fenster in der Kutikula), so kann man bei supinatorischer Bewegung des Cubitalsektors deutlich die Dehnung des Muskels beobachten. Dabei wird der gesamte Muskel gedehnt (sowohl die dorsalen wie auch die ventralen Faserpartien! Vgl. dagegen Tannert, 1958; Tabelle 1, S. 112f. und Anmerkung 6, S. 114).

Aus dem Beschriebenen ergibt sich, daß der fa bei seiner Kontraktion der Supinationsbewegung des Cubitalsektors entgegenwirkt — er ist demnach ein Pronator des Aufschlagsdrehbereichs.

Beim Aufschlag wird die Flügeloberseite angeströmt. Da die maßgebliche Drehachse E2 der Cubitalsektorbewegung den Flügel so durchschneidet, daß der größte Teil seiner Fläche sich kaudal von E2 befindet, wird der Flügel beim Aufschlag passiv supinatorisch, zur Richtung der anströmenden Luft hin, gedreht. Die passiven Kräfte wirken also entsprechend wie beim Abschlag, in diesem Fall jedoch nicht pronierend, sondern supinierend (vgl. S. 51). Der aerodynamische Anstellwinkel kann demnach beim Aufschlag durch einen pronatorischen Muskel vergrößert werden (vgl. Abb. 26b) — dafür kommt allein der fa, der einzige Pronator des Aufschlagsdrehbereichs, in Betracht (zur aerodynamischen Bedeutung des fa vgl. S. 95f.).

Der Cubitalsektor-Hebel CuSH ist als das wesentliche kraftübertragende Element zwischen dem Muskel fa und dem distalen Cubitalsektor zu betrachten. Er ist selbst biegsam und so funktionell weniger mit einem Hebel als mit einem flexiblen Kupplungsstück zu vergleichen. Je nach der Größe der Zugkräfte von distal (Luft) und proximal (fa) wird das geschwungene CuSH-Band verschieden stark abgeflacht ("in die Länge gezogen"), wobei der vor dem Skleritband liegende Membranspalt (ms) den für die

verschiedenen Biegezustände notwendigen Spielraum gibt. Für die Bewegung des CuSH sind aber noch weitere Strukturen in der dorsalen RAP, die hier nur kurz erwähnt werden können, wesentlich. So ist die RAP z.B. kaudal vom Gelenk t2 membranös eingeschnitten. Dieser Spalt, der sich parallel zum medialen Rand der RAP erstreckt (Abb. 1a), spielt bei der Verformung der kaudalen RAP durch den fa eine wesentliche Rolle und hält sie außerdem anscheinend von der Stelle t2 fern: Die Kraft des fa wirkt von kaudal auf den Membranspalt, wodurch der RAP-Rand nach medial bewegt (abgespreizt) wird. Dadurch wird der Schub auf das tergale Flügelgelenk t2 und den Tergalzapfen TZ verringert (die Bewegung des Randes nach medial wird ihrerseits in den Gelenken des Sklerits G2 "abgefangen"). Weitere strukturelle Besonderheiten der RAP sollen auf S. 62ff. beschrieben werden.

Das vordere Apodem des fa ist genau am pleuralen Hauptgelenk p2 des Flügels aufgehängt (Abb. 3). Dadurch befindet sich der Muskelursprung, bezogen auf den Auf- und Abschlag des Flügels, in einer neutralen Lage, d.h., die Flügelschlagbewegung beeinflusst den Muskel an dieser Stelle nicht, der Muskel seinerseits nicht die Schlagbewegung. Anders verhält es sich mit der von der P1/P2-Achse weiter entfernt liegenden kaudalen Muskelansatzstelle; sie macht die Auf- und Abschlagsbewegungen mit. Da der Muskelursprung jedoch über ein membranöses Sehnenstück am Fulcrum befestigt ist und so eine vielseitig bewegliche Aufhängung besitzt (die auch um die Achse P1/P2 drehbar ist — die Sehne wird dabei tordiert), führt der Flügelschlag zu keiner Torsion des Muskels: der fa wird als Ganzes zusammen mit der RAP um P1/P2 bewegt und ist damit funktionell als flügelinterner Muskel zu betrachten. Er könnte sich theoretisch zu jedem Zeitpunkt des Flügelschlags kontrahieren. Beim Abschlag ist der Flügel jedoch proniert angestellt und wird außerdem so angeströmt, daß sich der Cubitalsektor auf jeden Fall an seinem pronatorischen Anschlag befindet (s. S. 51, 54). Der fa wird in dieser Phase nicht gedehnt (belastet) oder gestaucht (entlastet), da er bei einer Veränderung der Flügelanstellung im Abschlagsdrehbereich zusammen mit der RAP bewegt wird, und der CuS dabei an seinem Anschlag bleibt. Nur die zur supinatorischen Verwindung des Flügels (und Abbiegung des CuS) führenden Kräfte bewirken eine Dehnung des Muskels, dessen Funktion so auf den Aufschlagsdrehbereich ein-



geengt werden kann. In diesem Bereich kann der *fa* den Cubitalsektor selbst bei maximaler Kontraktion (und fehlenden Gegenkräften) höchstens bis zu seinem pronatorischen Anschlag (0°-Anstellung, vgl. S. 46f., 54) bewegen — der Muskel ist wirkungslos, wenn der *CuS* durch andere Kräfte an seinem Anschlag gehalten wird. Er könnte also auch tonisch sein (vgl. aber S. 44) und wäre dennoch nur beim Aufschlag wirksam.

Der 3. Subalarmuskel *sub3* (Abb. 2 und 3) greift kaudal (wenig vor dem *sub2*) an der Unterseite der Cubitalsektor-Basis an und zieht nach ventral-lateral-kaudal. Der Muskel ist relativ schwach und kurz und enthält in seiner dorsalen Ansatzsehne ein längliches Stück Resilin. Da eine phasische Kontraktion des wenig lateral von der Schlagachse *P1/P2* ansetzenden Muskels beim Abschlag nur von sehr geringer Wirkung sein dürfte, ist von vornherein anzunehmen, daß der *sub3* tonisch aktiv ist (vgl. z.B. Hatch, 1966; auch eigene elektrische Reizversuche — s. S. 44 — sprechen dafür). Seine Kraftwirkung fällt dann aber (abgesehen von einer anfänglichen Federwirkung des Resilinstücks) nicht in die Abschlagsphase (wie Neville u.a. annimmt; vgl. Anmerkung 19, S. 116), sondern in die Aufschlagsphase: beim Abschlag wird der Muskel (wie eine Zugfeder) gestaucht und entlastet, beim Aufschlag dagegen belastet. Der *sub3* würde demnach (ähnlich wie der *bas2*, vgl. S. 45) v.a. die Aufschlagsgeschwindigkeit des Flügels vermindern. Da er auch einen Hebelarm zur Cubitalsektor-Drehachse *E2* besitzt<sup>1)</sup>, supiniert er den Flügel gleichzeitig (auf diese Doppelfunktion soll in der Diskussion noch einge-

gangen werden — s. S. 95f; zur weiterhin möglichen Beteiligung des Muskels an der unteren Flügel-Wendepunktsdrehung s. S. 98). Möglicherweise ist die 2-fache Wirkung des Muskels z.B. bei sitzenden Libelluliden direkt zu beobachten: sie ziehen die Flügel, v.a. bei Annäherung eines Feindes, nach unten-vorn (manchmal mit wenigen, ruckartigen Bewegungen) und verwinden sie dabei stark supinatorisch. Die erste Schlagphase, ein Aufschlag, der die Libelle v.a. nach vorn treibt, wäre damit "vorbereitet" (zur Vortriebswirkung des Aufschlags vgl. S. 96).

Der 2. Subalarmuskel *sub2* wurde schon auf S. 50f. besprochen und als der wesentliche Muskel zur Vergrößerung des aerodynamischen Anstellwinkels beim Abschlag interpretiert. Dieser Muskel setzt zwar wie der *sub3* auch am Cubitalsektor an (Abb. 3), da seine Zugrichtung jedoch praktisch mit der Ausrichtung des Cubitalsektor-Epifulcrum-Gelenkes *e2* zusammenfällt, bewegt er die *RAP* supinatorisch als Ganzes (was nur im Abschlagsdrehbereich möglich ist!). Er würde demnach — falls er beim Aufschlag kontrahiert würde — keine Supinationsbewegung des Cubitalsektors (relativ zum *CoS*) bewirken, sondern nur der Aufschlagsbewegung entgegenarbeiten.

<sup>1)</sup> Dieser Hebelarm ist im Metathorax der Anisopteren sehr klein — möglicherweise ein sekundärer Zustand, der im Zusammenhang mit der besonderen Spezialisierung des Segments in dieser Gruppe steht (vgl. S. 61f., 95 f., 101, 110).

Abb. 9. Prinzipschemata der Flügelstellbewegungen. Die Teile wurden zu Platten (*CP* und *RAP*) und Gestängen (*CoS*, *CuS*) vereinfacht; die distalen Verbindungen der Flügelsektoren wurden weggelassen. Die *RAP* ist in den einzelnen Bildpaaren dorsal-proximal auf verschiedener Höhe angeschnitten; die *CP* zeigt im vorderen Bereich (*vCP*, *mCP*) einen Anschnitt auf der Höhe des Pleurum und wurde nur kaudal (*phCP*) in ganzer Ausdehnung (nach proximal vorragend) gezeichnet. Widerlagerbildende (bei den Bewegungen ortsfeste) Teile dunkel (Flügeloberseite) oder schwarz (Unterseite), ihre Anschnitte und Kanten weiß gekennzeichnet; bewegte Teile weiß (Flügeloberseite) oder schraffiert (Unterseite, Anschnitte und Kanten). Muskelbezeichnungen nur für kontrahierte Muskeln eingetragen. *a* → *b* Pronation im Abschlagsdrehbereich (*b* → *a* Supination). Die kleinen Pfeile an der Achse *C1* (die vereinfachend als Scharnierachse angesehen wird) deuten eine (geringe) Verstellung dieser Drehachse an (s. S. 50). Die "eigentliche" Drehachse liegt zwischen *C1* und *P2/C4* (s. S. 50). Der bei *x<sub>2</sub>* in (*a*) kaudal von der Achse *P2/C4* (und lateral von der Schlagachse) angreifende *sub1* wurde nicht eingezeichnet (der *bas1* greift bei *x<sub>1</sub>*, am Widerlager, an). Die dem vorderen Epifulcrum-Gelenk *e1* (→ Achse *E1*) gegenüberliegende Gelenkzone in der *RAP*-Dorsalseite (vgl. S. 42) wurde stark vereinfacht als Gelenkeinschnitt dargestellt. *c* → *d* Supination im Aufschlagsdrehbereich (*d* → *c* Pronation). Der *sub3* wurde nicht eingezeichnet (er ist in *d* kontrahiert bzw. — bei passiver Supination — gestaucht). *e* → *f* Vorschwingen des Vorderflügels — der Flügel sei weitgehend abgeschlagen (*f* → *e* Zurückschwingen). Zur Wirkung des *d<sub>lm</sub>*, *d<sub>vm1</sub>* und *pa* s. S. 60f. (*pa* nur bei Zygopteren und *Epiophlebia*); zur Drehung der *RAP* im *p2*-Resilingelenk und Auslenkung von *RAP*+*Fulcrum* im Gelenk *fu* vgl. S. 58f.

VERÄNDERUNG DER FLÜGELSCHLAGBAHN —  
 "VOR- UND ZURÜCKSCHWINGEN" DES FLÜGELS

Diese Bewegungsmöglichkeit des Flügels ist bei Anisopteren nur im Vorderflügel-Segment entwickelt, im Metathorax dagegen reduziert. Daß ein Vor-Zurückschwing-Mechanismus bei

Libellen ursprünglich in beiden Segmenten vorhanden war (allerdings im Metathorax mit einer abweichenden tergalen Mechanik und einem "konträren" Muskelantagonismus; s. S. 61f.), ergibt sich aus dem Vergleich mit Zygopteren und Anisozygopteren; auf diese Gruppen kann hier jedoch nur kurz eingegangen werden.

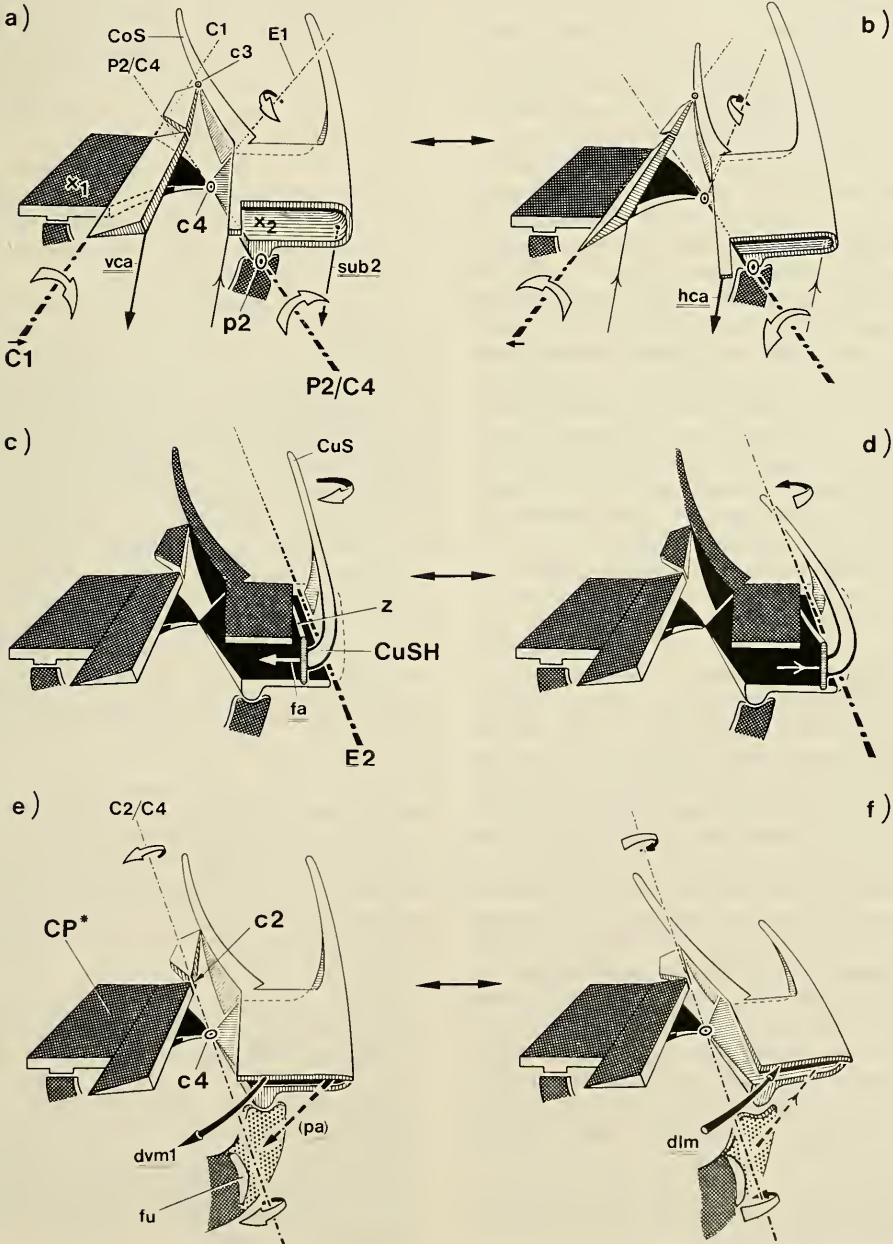

Mechanik. — Hier soll zunächst nur der Mechanismus des Flügelvorschwingens beschrieben werden. Auf den Rückschwing-Vorgang (der sich, durch Umkehrung, daraus leicht ergibt) wird im Zusammenhang mit den Kräften (s. weiter unten) eingegangen.

Bei der Vorschwingbewegung bildet die Tergalbrücke (Tb, Abb. 1a) zusammen mit der mittleren Tergalregion T und den beiden Flügeln (genauer den Flügeln ohne CP\*) eine Bewegungskette. Sie beginnt bei der Tergalbrücke, die in ihren lateralen Gelenken t1 gegenüber den CP\* nach hinten geschwenkt wird (Abb. 1b, c; Bewegung um die quer zum Tier stehende Scharnierachse T1/T1). Dadurch wird die Tergalregion T nach kaudal verschoben, die beiden über die Gelenke t2 mit den Flügeln in Verbindung stehenden Tergalzapfen (TZ) werden kaudad-dorsad gedrückt und bewegen gleichzeitig beide Flügel. Dabei spielt (jetzt für den einzelnen Flügel betrachtet) v.a. ein innerhalb des Flügels liegendes, aus zwei Gelenken zusammengesetztes Scharniergelenk c2/c4 (s. unten) eine wesentliche Rolle. Ein Flügel kann nämlich erst dann nach vorn schwingen, wenn die durch die beiden Gelenke c2 und c4 laufende Drehachse C2/C4 überhaupt "gebildet" ist und auch in einer bestimmten Ausrichtung zum Körper steht; da dies nur in einem kurzen, unteren Abschnitt des Flügel-schlags der Fall ist, ist der Mechanismus in den übrigen Phasenabschnitten erschwert bis gesperrt.

Die erste Voraussetzung ergibt sich aus der Lage und Struktur der beiden Gelenke c2 und c4: c2 liegt vorn in der Flügeloberseite zwischen der phCP und der dhCP (Abb. 1a und 3); c4 ist das schon bei der Besprechung des Abschlagsdrehbereichs erwähnte Gelenk in der Unterseite des Flügels zwischen der CP (mCP) und der RAP (Abb. 3, 7 und 10). Da c2 für sich ein Scharniergelenk darstellt, das bei Flügeldrehbewegungen im Abschlagsdrehbereich zusammen mit der hCP bewegt wird (wodurch sich die Ausrichtung der Achse C2 verändert), ist das zusammengesetzte Scharniergelenk c2/c4 (und damit die wesentliche Achse C2/C4 der Vorschwingbewegung) erst dann "funktionsfähig" wenn C2 auf c4 zielt. Dies ist der Fall, wenn sich der Flügel in einer bestimmten Anstellung, nämlich am supinatorischen Anschlag

des Abschlagsdrehbereichs, befindet (dagegen steht die Achse C2 z.B. bei einem extrem proniert angestellten Flügel, bei dem die hCP stark nach dorsal gebogen ist, fast parallel zur Flügel-fläche, und die Vorschwingbewegung ist in diesem Fall gesperrt; vgl. Abb. 9b, 14a und S. 47ff.)<sup>2)</sup> Das Gelenk c4, das sowohl im Abschlagsdrehbereich (bei der Bewegung des Flügels in den Gelenken p2/c4 und c1) als auch bei der Vorschwing-Bewegung (um C2/C4) eine Rolle spielt, ist seiner Struktur nach beiden Funktionen angepaßt (Abb. 10): die RAP greift (an der Stelle, wo das Epifulcrum-Gelenk e1 proximal beginnt) mit Fortsätzen so in die ventrale mCP ein, daß Bewegungen um beide Drehachsen möglich sind; sie ist andererseits an dieser Stelle mit der CP so "verzahnt", daß sich CP und RAP bei den Schlagbewegungen wechselseitig "mitnehmen" (vgl. S. 50).

Die zweite Voraussetzung folgt aus der sich im Verlauf des Flügelschlags relativ zum Körper verändernden Ausrichtung der Achse C2/C4. Diese steht beim aufgeschlagenen Flügel etwa in einer Sagittalebene (nahezu senkrecht, nach vorn geneigt), wird gegen Ende des Abschlags dagegen durch eine Horizontalebene bewegt. Während die Vorschwing-Bewegung beim aufgeschlagenen Flügel gesperrt ist — sie würde zu einer Bewegung des kaudalen RAP-Randes nach lateral führen, was jedoch infolge des seitwärts nicht dehnbaren hinteren Tergalbereichs nicht möglich ist<sup>3)</sup> — wird sie im Verlauf des Abschlags, jenseits der Schlagmitte, allmählich "freigegeben". Die Achse C2/C4 wird dabei anscheinend mehr und mehr "entsprechend einer im Gelenk t2 bestehenden RAP-Bewegungsmöglichkeit relativ zum Tergum" ausgerichtet. Eine Vorschwingbewegung wäre jedoch dennoch nicht durchführbar, wenn nicht auch eine Bewegung gegenüber dem Pleurum stattfinden könnte; die Achse C2/C4 verläuft ja medial nicht durch das Gelenk p2 hindurch, sondern wenig vor ihm vorbei (Abb. 9). Diese Relativbewegung der RAP wird wohl weitgehend

2) Somit kann eine Bewegung der dhCP im proximalen Gelenk c2 erst dann stattfinden, wenn im distalen Gelenk c3 der 0°-Anschlag erreicht ist (vgl. S. 50). Die nach Tannert (1958, l.c. Abb. 29) bestehende "unabhängige Wirkungsweise" der beiden Gelenke c2 und c3 trifft also nicht zu.

3) Erst wenn man den kaudal von t2 befindlichen Rand der RAP vom Tergum vollständig abtrennt, ist die Bewegung um C2/C4 auch im oberen Schlagbereich möglich.

1) Unter der CP\* wird der proximale Teil der CP (vCP + mCP + phCP), also die CP ohne dhCP, verstanden (s. Abb. 1b).





Abb. 10. Das Gelenk c4 (Innenansicht — rechter Vorderflügel von *Aeshna cyanea*). Apodem des fa weggelassen. Punktiert: Membranverbindungen und Resilin (r); das Resilinpolster ist im Vorderflügel besonders groß und spielt dort auch beim Flügelvorn- und -zurückschwingen eine Rolle (vgl. unten). Das Gelenk c4, das zwischen der ventralen mCP und der RAP liegt, gestattet Pronations-Supinationsbewegungen im Abschlagsdrehbereich (p, s; Achse P2/C4) und Vor-Zurückschwing-Bewegungen (v, z; Achse C2/C4); beim Flügelschlag sind RAP und (m)CP (durch die "Verzahnung" der Teile bei c4 — und durch ein weiteres Gelenk, c3) eng aneinander gekoppelt. CH: ventraler Ansatzstift des Chordotonalorgans.

durch das Resilinpolster des Gelenkes p2 selbst ermöglicht (Verlagerung und Drehung des Epifulcrum-Zapfens gegenüber dem Fulcrum), führt aber außerdem anscheinend — in einem an der Gabelungsstelle der Pleuralleiste liegenden, ventralen Gelenk des Fulcrum (fu, Abb. 9e) — zu einer Seitwärts-Auslenkung des ganzen Fulcrum. (Wahrscheinlich ist das Gelenk fu, das für eine federnde Auflage des Flügels sorgt, außerdem auch beim Flügelschlag von Bedeutung.)

Die durch die Gelenke c2 und c4 verlaufende Drehachse C2/C4 steht schräg zum Flügel. Sie ist (beim horizontal gestellten Flügel) von unten-innen-hinten nach oben-außen-vorn ausgerichtet (Abb. 1b). Die relativ zur CP\* stattfindende "Vorschwing"-Bewegung ist dement-

sprechend kompliziert: die Flügelspitze bewegt sich zunächst v.a. nach vorn-unten und dann — da die flügelinterne Achse C2/C4 zusammen mit dem gleichzeitig weiter abschlagenden Flügel weiterbewegt wird und so ihre Ausrichtung verändert — nach medial-dorsal (Abb. 28, 29), wobei gleichzeitig auch eine Art "Supination" stattfindet. Diese letztgenannten Bewegungen sind jedoch als Komponenten der Vorschwing-Bewegung anzusehen und dürfen nicht mit den auf S. 46ff. und 43 ff. beschriebenen Drehbewegungen um die Längsachse oder mit der Schlagbewegung des Flügels (beide geschehen ja um andere, eigene Achsen) verwechselt werden. Man könnte die Vorschwing-Bewegung aufgrund ihrer supinatorischen Komponente (die am kaudalen Senken der RAP in der Abb. 1b und 9f zu erkennen ist) auch als eine Art "Fortsetzung" der Supination des Abschlagsdrehbereichs mit anderer Mechanik (und Muskulatur) bezeichnen: sie beginnt erst dann, wenn sich der Abschlagsdrehbereich an seinem Anschlag befindet (s.S. 50 und weiter oben).

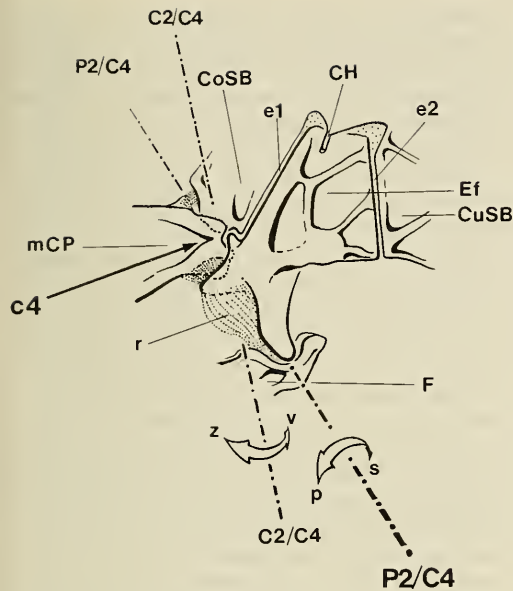
In der Bewegungskette Tb-T-RAP wird eine Schwenkbewegung der Tergalbrücke (um die Querachse T1/T1) und Schubbewegung des Tergum in eine Flügelbewegung (um die schräg zu T1/T1 stehende Achse C2/C4) "umgesetzt". Dies ist nur möglich, wenn noch weitere Gelenke und Biegestellen mitwirken. So spielt z.B. ein Gelenk zwischen der Tergalbrücke und der mittleren Tergalregion T (s, Abb. 1b, c) eine wichtige Rolle. Außerdem ist der Tergalzapfen TZ gegenüber T biegsam — er wird in einem Gelenkeinschnitt seiner Basis tordiert (der Gelenkeinschnitt wird während des Schubvorganges verengt). Schließlich wird eine Bewegung des Tergum nach kaudal, relativ zur CP\*, v.a. dadurch ermöglicht, daß die Tergum-Mittenregion T gegenüber den tergalen Seitenbereichen in der Tierlängsrichtung verschiebbar ist (s. auch weiter unten): die Bewegung läuft proximal an der CP\* entlang, "umgeht" sie gewissermaßen. Da das Gelenk p1 der CP\* ein in der Tierlängsrichtung verlaufendes Scharniergelenk darstellt (vgl. z.B. Abb. 7), ist andererseits distal dafür gesorgt, daß die CP\* das für eine effektive Vorschwingbewegung notwendige stabile Widerlager bildet; die Bewegung wird dadurch von dem die Costalplatte betreffenden Teil des Flügelantriebs unabhängig.

Wie auf S. 37ff. schon beschrieben wurde, geht das Tergum T seitlich in die Apodem-Einstülpung des indirekten Hebers *dvml* über und grenzt dann weiter lateral (unter Vermitt-

lung der Sklerite vTS, hTS und RS) an die Costalplatte. Verschiedene Gelenke dieses Tergum-Seitenbereichs (der sich kaudal weiter bis zum TZ erstreckt) spielen bei der Schubbewegung von T eine Rolle: 1) ein Resilingelenk zwischen der Tergalbrücke und dem Sklerit vTS (s. Abb. 1a, ohne nähere Bezeichnung), 2) der Gelenkspalt zwischen vTS und hTS, 3) der Gelenkeinschnitt zwischen vTS und RS und 4) eine Membranzone zwischen der medialen Wandung des dvm1-Apodems und T (m, Abb. 1a) — kaudal geht die Wand des Apodems allerdings sklerotisiert in den Tergalzapfen über, so daß der untere Teil der Medialwand des dvm1-Apodems zusammen mit dem TZ bewegt wird und dabei durch die Membran m gegenüber T einen Bewegungsspielraum erhält (dies erscheint notwendig, wenn man die oben erwähnte Torsion des TZ bedenkt; s. dazu auch unten). Da die Zugwirkung von kaudal auf den hTS (t2-Bewegung) stärker ist als die Schubwirkung von proximal auf den vTS (Tb-Bewegung), wird der Winkel zwischen vTS und hTS beim Flügelvorschwingen stumpfer — der Tergum-Seitenbereich wird also gestreckt. Die Tergalbrücken-Bewegung wirkt sich dadurch auch nach seitlich auf den Randsklerit aus, bleibt aber anscheinend ohne mechanische Auswirkung auf die CP\* selbst, da die (geringe) Bewegung des vTS nach lateral weitgehend in den Gelenken des RS abgefangen wird (der RS kann zwar im Gelenk t1 eine Bewegung nach lateral durchführen, sein distal in den Flügel reichender Fortsatz — an dem der vca ansetzt — gleitet dabei aber lediglich, in einer Führung der Unterseite der phCP, an der CP entlang).

Beim Flügel-Vorschwingen wird also nur die dhCP (der distale Teil der CP) zusammen mit der RAP und dem Flügel bewegt, der Rest der CP stellt das Widerlager dar und bleibt in Ruhe. Im Verlauf des Vorschwingens wird der proximale Membranspalt zwischen CP und RAP vergrößert, der vor dem Gelenk c2 (zwischen der dhCP und CP\*) befindliche Gelenkspalt dagegen verengt (vgl. Abb. 1a → b; 9e → f). Schließlich schlägt der proximale Rand der dhCP an der phCP an und begrenzt den Bewegungsspielraum.

Kräfte. — Der dorsale Längsmuskel dlm ist der einzige Muskel (im Mesothorax), der den Flügel um die Drehachse C2/C4 nach vorn zu schwingen vermag (Abb. 1; 9e, f). Der Mechanismus ist jedoch (wie schon beschrieben wurde) nur in einem kurzen, unteren Abschnitt des

Flügelschlags (Ende Abschlag, Beginn Aufschlag) "freigegeben"; da dem dlm am Anfang der Aufschlagsphase ein erheblich kräftigerer Muskel (der dvm1, s. unten) antagonistisch gegenübersteht, läßt sich der Zeitpunkt der dlm-Kontraktion auf das Abschlagsende einengen.

Das dorsale Apodem des indirekten Hebers dvm1 ist zwar einerseits (bedingt durch Gelenkspalte und ein Membrangebiet, s. weiter oben) gegenüber der Tergalregion T und gegenüber der CP\* beweglich, andererseits jedoch kaudal fest mit dem Tergalzapfen TZ verbunden. Das dvm1-Apodem wird daher, wenn der Flügel am Ende des Abschlags nach vorn schwingt, aufgrund der Bewegung des TZ kaudal angehoben und damit insgesamt schräg gestellt; dabei wird der dvm1, v.a. im kaudalen Bereich, gedehnt. Setzt nun der Flügelaufschlag ein, so wirkt der dvm1 so lange zusätzlich als Rückschwingmuskel des Flügels, bis das Apodem wieder seine ursprüngliche Ausrichtung erreicht hat. Dies ist spätestens dann der Fall, wenn die zwischen phCP und dhCP befindliche Membran des c2-Gelenks straff gespannt ist und kein weiteres Rückschwingen mehr zuläßt. Von da an verteilt der dvm1 seine Kraft (nur noch flügelhebend) gleichmäßig auf die CP und RAP. Der dvm1 (zumindest sein kaudaler Abschnitt<sup>1)</sup>) ist somit am Aufschlagsbeginn als Antagonist des dlm flügelrückschwingend wirksam — ein Vorschwingen ist während des Flügelaufschlags nicht möglich. (Im Falle einer tonischen dlm-Kontraktion müßte ein Teil der dvm1-Kraft zu Beginn des Aufschlags gegen den dlm aufgebracht werden und ginge damit dem Aufschlag verloren; vgl. dazu auch S. 44, 100f.)

Ein effizientes Flügelvorschwingen (und vollständiges Ausnützen des Vorschwing-Bewegungsspielraums im unteren Abschnitt der Aufschlagsphase) erscheint v.a. dann möglich, wenn schon vor der Kontraktion des dlm Kräfte wirksam werden, die den Flügel supinatorisch bis zum Anschlag drehen und dann weiter auch am supinatorischen Anschlag halten (vgl. die "erste Voraussetzung", S. 58; s. auch Abb. 26e: Anströmung der Flügelunterseite während

<sup>1)</sup> Eine morphologische Unterteilung des dvm1 in eine vordere und hintere Portion (die diesem funktionellen Unterschied entspricht) konnte nicht gefunden werden: Der Muskel ist äußerlich einheitlich — die dorsale Tracheen-Einmündung teilt das Apodem und den Muskel nur scheinbar (vgl. auch S. 114f., Anmerkung 9).



des Vorschwingens!). Als ein in dieser Weise nützlicher "Hilfsmuskel" des dlm könnte etwa der vca eingesetzt werden, der als Supinator des unteren Schlagumkehrpunktes interpretiert wurde (vgl. S. 51). Der Muskel ist aber wahrscheinlich noch in einer weiteren Hinsicht für eine Unterstützung und Steigerung der dlm-Funktion geeignet: Da er einen Hebelarm zur Auf-Abschlagsachse P1/P2 besitzt, bremst er den Flügelabschlag gleichzeitig; dadurch kann die Vorschwingbewegung ihrerseits stärker zur Auswirkung kommen (vgl. Abb. 28a, b; zur möglichen aerodynamischen Bedeutung der Vorschwingbewegung s. S. 100).

Da die Achse T1/T1 in einer senkrecht zur Körperlängsachse stehenden Vertikalebene festliegt (d.h.: die Gelenke t1 sind weder nach vorn noch nach hinten relativ zueinander versetzbar), wird der Schub der Tergalbrücke stets auf die Radioanalplatten beider Körperseiten aufgeteilt; beide dlm wirken jeweils sowohl auf den rechten als auch linken Flügel. Es ist somit gleichgültig, ob nur ein Muskel sich stark kontrahiert oder ob beide Muskeln halb so stark arbeiten — die Muskeln der beiden Körperseiten sind als vollkommen funktionsgleich anzusehen. Ihre Auswirkung am Flügel wird jedoch von anderen Kräften mitbestimmt und kann demnach unilateral beeinflusst werden (z.B. durch den vca, s. oben; außerdem — bei Zygopteren und *Epiophlebia* — durch den pa, s. unten). Schlagasymmetrien, die zu einer Kippung der Tb um die Körperlängsachse führen, könnten außerdem eine (geringe) Rolle spielen (vgl. auch S. 46). Schließlich ist noch eine direkte Beeinflussung der mesothorakalen dlm durch das metathorakale Tergum zu bedenken, da die beiden Muskeln kaudal-lateral von der Vorder- randleiste (Antecosta) des Metathorax (ac<sub>III</sub>, Abb. 1) entspringen und der Tergum-Vorder- rand des Metathorax beim Flug mit dem Schlag der Hinterflügel auf- und abbewegt wird (dies wurde in der Abb. 1c angedeutet). Da die dlm jedoch kaudad auseinanderspreizen (sie greifen geradezu "so weit wie möglich" lateral an seitlichen Vorsprüngen der Antecosta an<sup>1)</sup>), dürften sich Phasenunterschiede der Vorder- und Hinterflügel nur geringfügig (über Dehnung oder Stauchung der Muskeln) direkt auf die Vorschwingbewegung auswirken. Eine stärkere in-

direkte Beeinflussung über das Postnotum erscheint mir dagegen möglich.

Nur die Zygoptera und die Anisozygoptera (Gattung *Epiophlebia*) besitzen im Mesothorax (vom Muskel dvm1, der den Flügel zu Beginn des Aufschlags auf jeden Fall in die Grundschlagbahnebene zurückschwingt, abgesehen) einen direkten Antagonisten des dlm, den Pleuroarmmuskel pa (Abb. 2; 9e, f<sup>2)</sup>). Dieser Muskel könnte z.B. für eine unilaterale Einstellung der dlm-Kraftwirkung wesentlich sein. Er könnte darüber hinaus (v.a. wenn der dlm nicht kontrahiert wird) auch für die Erzeugung besonders steiler Flügelschläge eingesetzt werden und würde den Schlagbahn-Spielraum zu besonders großen Winkeln hin erweitern (Abb. 28c). Darauf (und auf die mögliche aerodynamische Bedeutung des dlm und pa) soll in der Diskussion (S. 99ff. und S. 109f.) noch eingegangen werden.

Während der Vor- und Zurückschwingmechanismus im Hinterflügel-Segment der Anisopteren reduziert ist (s. weiter unten), findet er sich bei Zygopteren und Anisozygopteren in beiden Flügelsegmenten. Der metathorakale Mechanismus dieser Gruppen weist jedoch große Unterschiede (in der tergalen Mechanik und in den Muskelfunktionen) gegenüber dem mesothorakalen auf: Das Hebelapodem HA ist im Metatergum von der davor liegenden Tergalbrücke (deren Vorderrand die Antecosta III bildet) gelenkig abgesetzt und zur tergalen Mitte-region hin abgerückt; das Tergum selbst ist in zwei nach außen vorgewölbte, gegeneinander bewegliche Hälften geteilt, die seitlich jeweils ein Gelenk zum Tergalsklerit (vTS) besitzen. Kontrahiert sich der dlm, so werden diese beiden Tergalkuppeln auseinander bewegt und die Tergalzapfen TZ dadurch nach innen geschwenkt. Der Flügel wird in diesem Fall durch den dlm nach kaudal bewegt, also zurückgeschwungen. Der auch im Metathorax antagonistische pa bewirkt hier ein Vorschwingen. D.h.: im Metathorax haben die Muskeln dlm und pa jeweils die genau entgegengesetzte Funktion wie im Mesothorax<sup>3)</sup>. Vorderer Tergalsklerit

<sup>2)</sup> Zu diesem Muskel s. auch Anmerkung 14, S. 115.

<sup>3)</sup> Aus der entgegengesetzten Funktion der serial homologen Muskeln im Meso- und Metathorax kann man schließen, daß sie ursprünglich eine andere (im Falle der dlm wahrscheinlich in beiden Segmenten gleichartige) Funktion besaßen. Dieser Gedanke erscheint mir für die Rekonstruktion des ursprünglichen Flugapparates der Pterygoten sehr wesentlich (vgl. S. 78ff.).

<sup>1)</sup> Bemerkenswert ist, daß die metathorakalen dlm der Zygoptera und Anisozygoptera "normal" (plesiomorph) ausgerichtet sind: bei ihnen besteht die Gefahr einer störenden Einwirkung durch ein folgendes Segment ja nicht!



und Randsklerit (der letztere ermöglicht wie im Mesothorax durch sein proximales Gelenk zum vTS die vca-Funktion; vgl. S. 51) werden im Metathorax (ähnlich wie im Mesothorax) von der tergalen Vor-Zurückschwing-Mechanik nicht beeinflusst. Die Tergalbrücke des Metathorax (das Ursprungsgebiet der mesothorakalen dlm!) ist andererseits durch ihr kaudales Gelenk vom übrigen Metatergum unabhängig und bleibt bei der Vor-Zurückschwingbewegung des Hinterflügels in Ruhe (nicht jedoch bei der Schlagbewegung, bei der die Antecosta III auf- und abbewegt wird; vgl. oben).

Die Vor-Zurückschwing-Beweglichkeit der Flügel ist bei Zygopteren und Anisozygopteren in beiden Flügelsegmenten größer als bei Anisopteren. Außerdem sind in beiden Segmenten (vom dvm1 abgesehen) jeweils zwei Muskeln (dlm und pa) vorhanden. Der Gelenkspielraum im Gelenk c2/c4 ist jedoch im Hinterflügel kleiner als im Vorderflügel, was darauf hindeutet, daß beim Hinterflügel Schlagbahnveränderungen in geringerem Maße möglich sind als beim Vorderflügel. Außerdem läßt sich aus den Größenverhältnissen der Muskeln ableiten, daß die Vorschwingfunktion beim Vorderflügel (dlm) besser entwickelt ist als beim Hinterflügel (pa), während die Rückschwingmöglichkeit des Vorderflügels (pa) geringer ist als diejenige des Hinterflügels (dlm). Hier zeigt sich eine, bei den Anisoptera anscheinend weiter vorangetriebene, verschiedene Spezialisierung der beiden Segmente (vgl. auch S. 101 und S. 109f.).

Im Mesothorax der Anisoptera fehlt der direkte Antagonist des dlm, der pa; damit ist der (aktiv einstellbare) Bewegungsspielraum der Flügel (gegenüber Zygopteren und Anisozygopteren, die in dieser Hinsicht als plesiomorph anzusehen sind — vgl. dazu auch Anm. 14, S. 115, sowie S. 109f.) sekundär verkleinert. Im Metathorax ist der Vor-Zurückschwingmechanismus weitgehend reduziert — der pa fehlt, der dlm ist nur sehr schwach entwickelt (rudimentär), die Bewegungsmöglichkeit im c2/c4-Gelenk ist stark eingeschränkt. In diesem Segment ist außerdem das Metatergum erheblich vereinfacht: die Beweglichkeit der tergalen "Kuppeln" fehlt, das verkleinerte Hebelapodem sitzt fest an der Tergalbrücke, vTS und hTS — ursprünglich wohl beide auch im Metathorax vorhanden und durch ein Gelenk getrennt — sind zu einem Sklerit verschmolzen (vgl. auch S. 109f.). Durch diese Veränderungen, die eine direktere Übertragung der Heber- und Senkerkräfte auf den Flügel mit sich bringen, wird der Metathorax zu

einem nahezu reinen Antriebssegment.

Die großen Unterschiede im Vor-Zurückschwingmechanismus zwischen den Hauptgruppen der Odonata konnten hier nur angedeutet werden — sie bedürfen weiterer, vergleichender Untersuchungen.

## 2. FLÜGELMECHANOREZEPTOREN

### MECHANISCHE BEANSPRUCHUNG DER REZEPTOREN

Das Chordotonalorgan in der Radioanalplatte

Auf der Flügelunterseite, wenig distal vom Epifulcrum, befindet sich eine kleine, apodemartige Einstülpung, der ventrale Ansatz des Flügel-Chordotonalorgans (CH, Abb. 3, 10 und 13a). Von dieser Stelle ausgehend zieht der Rezeptor nach dorsal-medial zur Kutikula der Oberseite der RAP (dorsaler Ansatz s. Abb. 1a, 11a und 15). Die ventrale Ansatzstelle befindet sich innerhalb einer brückenartigen Sklerotisierung, die sich von der Basis des Costalsektors aus nach kaudal bis zur Basis des Cubitalsektors erstreckt und nach proximal und distal durch Membran sowohl vom Epifulcrum als auch vom distalen Flügel abgesetzt ist. Der CH-Ansatz unterteilt diese Skleritbrücke in zwei Teilstücke — ein kürzeres vor der Ansatzstelle und ein längeres dahinter — die als "Hebelsklerite" des CH aufgefaßt werden (vCH, hCH: vorderer und hinterer Hebelsklerit des Chordotonalorgans).

Das Chordotonalorgan von *Anax imperator* Leach (der Art, an der auch die elektrophysiologischen Experimente durchgeführt wurden) ist etwa 0,5 mm lang. Phasenkontrast- und polarisationsoptische Untersuchungen zeigten, daß das Organ bei *Anax* ungefähr 50 Scolopidien enthält<sup>1)</sup>. Die Zahl der Sinneszellen ist jedoch höher: eine elektronenmikroskopische Analyse (Risler in Vorb.) ergab, daß einige Scolopidien mehrere Sinneszellen enthalten.

Da der Rezeptor innerhalb der RAP (distal von der Auf-Abschlagsachse P1/P2) liegt, wird er durch die Schlagbewegungen nicht beeinflusst (jedenfalls nicht direkt; vgl. dazu S. 96f.). Auch bei der Vor-Zurückschwingbewegung wird die RAP als Ganzes bewegt und das CH daher weder gedehnt noch gestaucht. Die Drehungen

<sup>1)</sup> Erhardt (1916) gibt für das CH im Flügel von *Coenagrion puella* (L.) dagegen nur 16 Stifte an.



Abb. 11. (a) Blick auf die Flügelbasis des rechten Vorderflügels von *Anax imperator*. Dorsales Ansatzgebiet des Chordotonalorgans punktiert. Das Sensillenfeld CF2 verläuft in der proximalen Fortsetzung der Radius+Media-Ader in einer Furche ( $\diamond$ ), das Feld CF1 ( $\blacklozenge$ ) verschwindet basal hinter der Radius-Kante. Vgl. mit Abb. 1a, 3 und 15. Maßstab 1 mm; (b) Ansicht der beiden Felder campaniformer Sensillen von vorn-oben; rechter Flügel abgeschlagen (Flügelspitze also links unten). CF1 ( $\blacklozenge$ ) und CF2 ( $\diamond$ ) sind fast in ganzer Ausdehnung zu erkennen. Maßstab 0,1 mm.

des Flügels um die Längsachse führen dagegen zu deutlichen Längenänderungen des Organs. Dies soll im folgenden für die pronatorischen und supinatorischen Drehbewegungen innerhalb der Schlagphasen und an den Schlagwendepunkten näher untersucht werden.

Supiniert der Flügel in der Aufschlagphase, so wird der Cubitalsektor ventral gegenüber dem Epifulcrum bewegt (vgl. S. 53f.); der nach vorn über die Epifulcrum/Cubitalsektor-Drehachse E2 hinausragende hintere Hebelsklerit (hCH) setzt die Skleritbrücke des CH dabei unter Spannung und "faltet" sie gewissermaßen in das Lumen der RAP hinein (Abb. 14c→e, 17a)<sup>1)</sup>. Da sich der ventrale Ansatzpunkt des CH dabei sehr genau in Richtung des CH-Verlaufs nach dorsal-medial bewegt, wird das CH entspannt (bzw. gestaucht). Eine entgegengesetzte, pronatorische Bewegung des Cubitalsek-

tors führt dagegen zur Dehnung des Organs; dies geschieht z.B. bei verstärkter Kontraktion des Fulcroalarmuskels in der Aufschlagphase (vgl. S. 54f.). Am oberen Schlagwendepunkt, wenn der Cubitalsektor seinen Anschlag am Arculus erreicht (s.S. 54), ist das CH maximal gedehnt (Abb. 14e→c).

Kontrahiert sich an der Auf-Abschlagswende der hintere Coxoalarmuskel hca, wird der Flügel pronatorisch im Abschlagsdrehbereich bewegt und verwunden (vgl. S. 47ff.). Jetzt bewegt sich der Costalsektor relativ zum Epifulcrum (um die Epifulcrum/Costalsektor-Drehachse E1) und setzt die Skleritbrücke des CH von vorn her unter Spannung; die Ansatzstelle des CH wird erneut nach oben-innen bewegt und das CH entdehnt (Abb. 14c→a; 17a). In der folgenden Abschlagsphase wird die Verwindung des Flügels und damit der Dehnungszustand des CH wie in der Aufschlagphase vom Kräfteverhältnis der passiv verwindenden Luft und der (in diesem Fall supinatorischen) Muskeln bestimmt (vgl. S. 50f.). Die erreichbare maximale Verwindung ist im Abschlagsdrehbereich relativ geringfügig (vgl. S. 54, 102); da der vordere Hebelsklerit außerdem kürzer ist

<sup>1)</sup> Die im Ausgangszustand (0°-Anstellung) schon vorhandene Biegung des Sklerits vCH+hCH nach medial sichert — ebenso wie der ventrad umgeschlagene proximale Rand des Sklerits (Abb. 17a) — die Skleritbrücke gegen eine "Faltung" in die entgegengesetzte Richtung (nach außen).



als der hintere, wird das CH in der Abschlagsphase weniger weit entdehnt als in der Aufschlagsphase (vgl. Abb. 17b). Am unteren Schlagwendepunkt ist der Rezeptor — bei Erreichen des supinatorischen Anschlags des Abschlagsdrehbereichs — erneut kurzzeitig maximal gespannt (Abb. 14a→c).

Das Flügelchordotonalorgan durchläuft demnach an beiden Schlagumkehrpunkten ein Dehnungsmaximum. Entdehnungen finden in der Auf- und Abschlagsphase statt (Dehnungsminimum bei extremer Supination bzw. extremer Pronation). Je nach deren Ausmaß ist der Abstand zum Längenmaximum (das an den Wendepunkten wohl stets erreicht bzw. durchlaufen wird) unterschiedlich groß. Je nach der Geschwindigkeit der Schlagwendepunktsdrehungen (abhängig v.a. von der Kontraktion der Wendepunktsmuskeln; vgl. dazu auch S. 97f.) wird die maximale Rezeptor-Länge verschieden rasch erreicht.

#### Felder von campaniformen Sensillen und Sinnesborsten

Auf der Oberseite der Radioanalplatte liegen im vorderen Bereich zwei lange Reihen von campaniformen Sensillen (CF1 und CF2; Abb. 1a, 3, 11 und 12); sie erstrecken sich etwa in der Flügel längsrichtung und folgen dabei dem Verlauf von Radius und Media, die in der RAP noch ein Stück weit zu erkennen sind. Bei *Anax imperator* Leach sind die Einzelsensillen im basalen Abschnitt der Felder äußerlich als bis etwa 20 µm lange, stark schlitzförmige Einsenkungen zu erkennen; nach distal werden die Schlitze kürzer (bis weniger als ein Drittel der Länge der proximalen Sensillen) und z.T. auch oval bis rundlich.

Erhardt (1916) beschrieb verschiedene solcher "Porenfelder" in der Flügelbasis von *Coenagrion puella* (L.) und bei anderen Libellen. Ihr fiel ebenfalls die große Mannigfaltigkeit in der Ausbildung (Form und Größe) des äußeren Kutikularapparates auf (runde, ovale oder spaltförmige Gruben). Extrem schlitzförmige Poren bei *Hemianax papuensis* (Burmeister) bezeichnete Simmons (1978) als "crevice organs" und verglich sie mit den Spaltsinnesorganen der Spinnen. (Derartig schmale Sensillengruben sind auch bei *Anax* ganz proximal vorhanden; sie erlauben wahrscheinlich genauere Rückschlüsse auf die mechanische Beanspruchung und Verformung der Kutikula — s. weiter unten.) Dieser Autor unterschied bei *Hemianax papuensis* vier Sensillenfelder, alle auf der Flügel-Dorsal-

seite, an der Basis der Radius + Media-Ader. Bei den hier untersuchten Arten (*Anax imperator* Leach, *Aeshna cyanea* Müll.) konnte eine solche Unterteilung jedoch nicht aufgefunden werden — auch nicht bei einem Vertreter der Gattung *Hemianax* (*H. ephippiger* Burm.), der zum Vergleich herangezogen wurde. Es fanden sich stets nur zwei Felder, deren Einzelsensillen — ohne größere Unterbrechungen — in geschlossener Reihe angeordnet sind: CF2 umfaßt dabei Simmons' "field 1 + 3 + 4", CF1 entspricht dem "field 2". Sowohl im Vorder- als auch im Hinterflügel von *Anax imperator* wurden je 90 bis 105 Sensillen pro Feld gezählt, wobei das CF1 6 bis 12 Rezeptoren weniger als das CF2 aufwies; bei *Aeshna cyanea* enthielten beide Felder (in beiden Flügeln) jeweils etwa 80 Einzelsensillen. Eine genauere raster-elektronenmikroskopische Untersuchung zeigte, daß sich die Ausrichtung der Längsachsen der einzelnen Sensillengruben im Verlauf der Felder in charakteristischer Weise verändert (teilweise zu erkennen in der Abb. 12).

Beide Sensillenfelder werden anscheinend nur durch die Drehbewegungen des Flügels um die Längsachse mechanisch beansprucht<sup>1)</sup>. Die Spannungsänderungen in der Kutikula der proximalen RAP sind allerdings äußerlich nicht sichtbar, wie etwa die Längenänderungen des Chordotonalorgans (die an der Ein-Auswärtsbewegung des ventralen Ansatzgebietes direkt beobachtet werden können). Innerhalb der Sensillenreihen wurden daher feine Längs-Einschnitte in der Kutikula angebracht, die bei gleichzeitiger Drehung des Flügels beobachtet wurden. Ein Aufklaffen der Schnitte im Verlauf der Drehbewegung wurde als Zugbeanspruchung der Kutikularapparate der dort liegenden Sensillen (quer zum Flügel, in der Längsrichtung der Gruben) interpretiert. Eine Pronation des Flügels im Abschlagsdrehbereich (welche proximal, wie beschrieben wurde, mit einer Relativbewegung der Costalsektor-Basis gegenüber der restlichen RAP verbunden ist), führt danach zu einer Zugbeanspruchung der Kutikula quer zum Feld CF1 (Abb. 14c→a); eine Supination im Aufschlagsdrehbereich (Bewegung des Cubitalsektors relativ zur restlichen RAP) verursacht dagegen eine Zugbeanspruchung

<sup>1)</sup> Auch Simmons (1978) vermutete (unter Bezug auf Neville, 1960), daß die Rezeptoren in einem funktionellen Zusammenhang mit der Verwindung des Flügels stehen; er gab jedoch keine näheren Erläuterungen dazu.





Abb. 12. (a) Proximaler Abschnitt des Sensillenfeldes CF1 (Ansicht wie in Abb. 11b); hier befinden sich die längsten Kutikular-Schlitzte (bis ca. 20  $\mu\text{m}$ ). Maßstab 10  $\mu\text{m}$ ; (b) Mittlere-distale CF1-Sensillen (Ansicht wie in Abb. 11b) — die Kutikulargruben stehen in der Mitte des Feldes schräg zur Radius-Ader, an beiden Enden fast senkrecht zu ihr. Im Hintergrund das Feld CF2. Maßstab 0,1 mm; (c) Aufsicht auf die Basis des Feldes CF2 (Flügelspitze unten). Maßstab 10  $\mu\text{m}$ ; (d) Aufsicht auf mittlere-distale Sensillen des Feldes CF2. Die Kutikulargruben der mittleren Sensillen sind (gegenüber den basisnahen und distalen Gruben) mehr in Flügellängsrichtung ausgerichtet (ähnlich wie beim CF1). CF1 rechts zu erkennen. (Zum gebogenen Gesamtverlauf des Feldes vgl. auch Pfau, 1983, l.c. Abb. 2—3c.) Maßstab 0,1 mm.

quer zu CF2<sup>1)</sup>) (Abb. 14c→c; die mögliche Übertragung der Zugkräfte von der dorsalen Cubitalsektor-Basis über die kaudal abgelenkte Media-Basis zum Feld CF2 wird in der

<sup>1)</sup> Diese ist — infolge der Großen Distanz des Feldes zum CuS — wohl geringer als im Falle des CF1, was aber u.U. durch die stärkere Cubitalsektor-Bewegung (s.S. 53f.) "wettgemacht" wird.

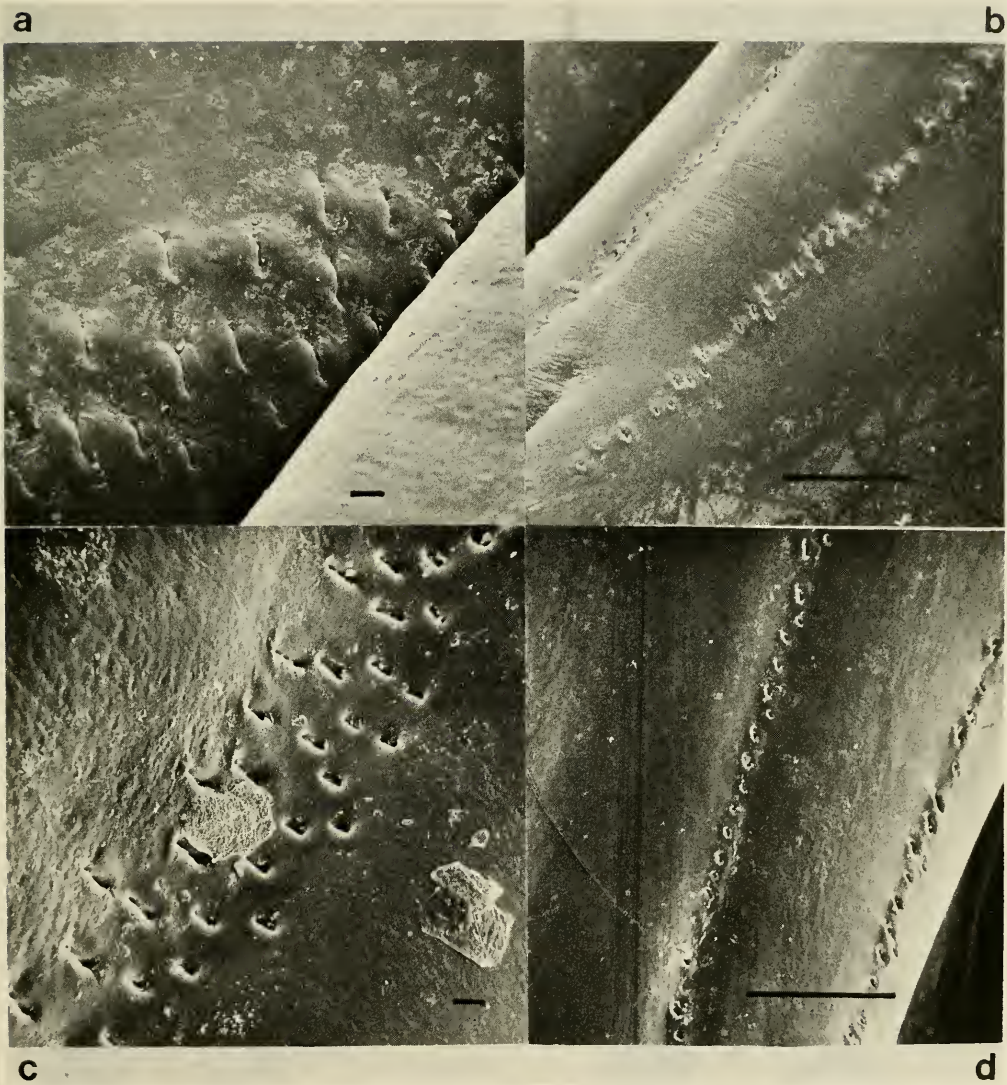

Abb. 13. (a) Unterseite des aufgeschlagenen rechten Vorderflügels von *Anax imperator*, von schräg vorn betrachtet. Das hintere Gelenk des Epifulcrum, e2 ( $\rightarrow$ ), ist nur andeutungsweise zu erkennen; am unteren Ende wird es von dem borstentragsenden Auswuchs BF2 überragt.  $\square$  kennzeichnet die ungefähre Lage des ventralen CH-Ansatzpunktes. BF1 rechts unten. Vgl. mit Abb. 7 und 17a. Maßstab 0,1 mm; (b) Blick auf das Borstenfeld BF1 von kaudal-ventral (rechter Vorderflügel); BF2 am linken unteren Bildrand noch erkennbar. Maßstab 0,1 mm.

Abb. 15 dargestellt). In beiden Drehbereichen nehmen die Zugspannungen bei Drehung zur  $0^\circ$ -Anstellung zurück wieder ab (Abb. 14a  $\rightarrow$  c, e  $\rightarrow$  c).

Eine kleinere Anhäufung von kurzborstigen Haarsensillen findet sich ganz proximal auf der Unterseite der Costalsektor-Basis (BF1; Abb. 7, 13 und 17a<sup>1</sup>). Sie liegt auf einem nach kaudal über das Costalsektor/Epifulcrum-Gelenk e1 hinausragenden Auswuchs, dem verdickten Anfang der Subcosta. Ähnliche Sinneshaare sitzen "gegenüber" (auf der anderen Seite des Epiful-

crum — am proximalen, vorderen Rand der Cubitalsektor-Basis) auf dem frontad über das Cubitalsektor/Epifulcrum-Gelenk e2 hinausragenden (kleineren) Fortsatz BF2. Beide Kutikularauswüchse stellen weiche Stoppstellen ("Anschläge") für die Verwindungsbewegungen der Flügelsektoren dar. Die inneren Borsten des Feldes BF1 kommen bei starker pronatorischer Verwindung im Abschlagsdrehbereich, diejenigen des Feldes BF2 dagegen bei starker Supination im Aufschlagsdrehbereich, mit der Außenwand des Epifulcrum in Kontakt und werden abgelenkt (Abb. 13b und 14a, e). Selbst bei diesen extremen Anstellungen wird das Epifulcrum aber offensichtlich nur von wenigen Haaborsten direkt berührt, so daß für die Erregung der

<sup>3</sup>) Wenig distal vom Feld BF1 liegen zwei kleinere Felder campaniformer Sensillen, die hier nicht weiter berücksichtigt wurden (cf, Abb. 17a).

Abb. 14. Schematische Darstellung der Beanspruchung von Mechanorezeptoren der Radioanalplatte bei Pronation und Supination. Blick von distal-dorsal auf die durch einen Querschnitt geöffnete Basis des linken Flügels (der Schnitt verläuft im vorderen Bereich schräg, der Querader  $cr_2$  folgend). Fulcrum und Epifulcrum wurden eingezeichnet, obwohl sie (bei dieser Ansicht) eigentlich verdeckt sind; die ventrale Verbindung von CP und RAP (mCP-Fortsatz und Gelenk c4) wurde weggelassen (vgl. andere Abb.). Epifulcrum mit Orientierungslinie.  $\odot$  "benutzte" Gelenke,  $\bullet$  "stillsiehende" Gelenke; (c)  $0^\circ$ -Anstellung (vgl. Abb. 6); c  $\rightarrow$  a Pronation (a  $\rightarrow$  c Supination) im Abschlagsdrehbereich; c  $\rightarrow$  e Supination (e  $\rightarrow$  c Pronation) im Aufschlagsdrehbereich; a  $\rightarrow$  e Supination des unteren Schlagwendepunkts; e  $\rightarrow$  a Pronation des oberen Schlagwendepunkts. Helle Pfeile kennzeichnen die Bewegungen der Skelettelemente, schwarze die Bewegungen des CH-Ansatz-Stiftes bzw. Zugbeanspruchungen in der Kutikula (zur Übertragung der Kutikularspannungen auf das Sensillennfeld CF2 vgl. auch die Abb. 15).



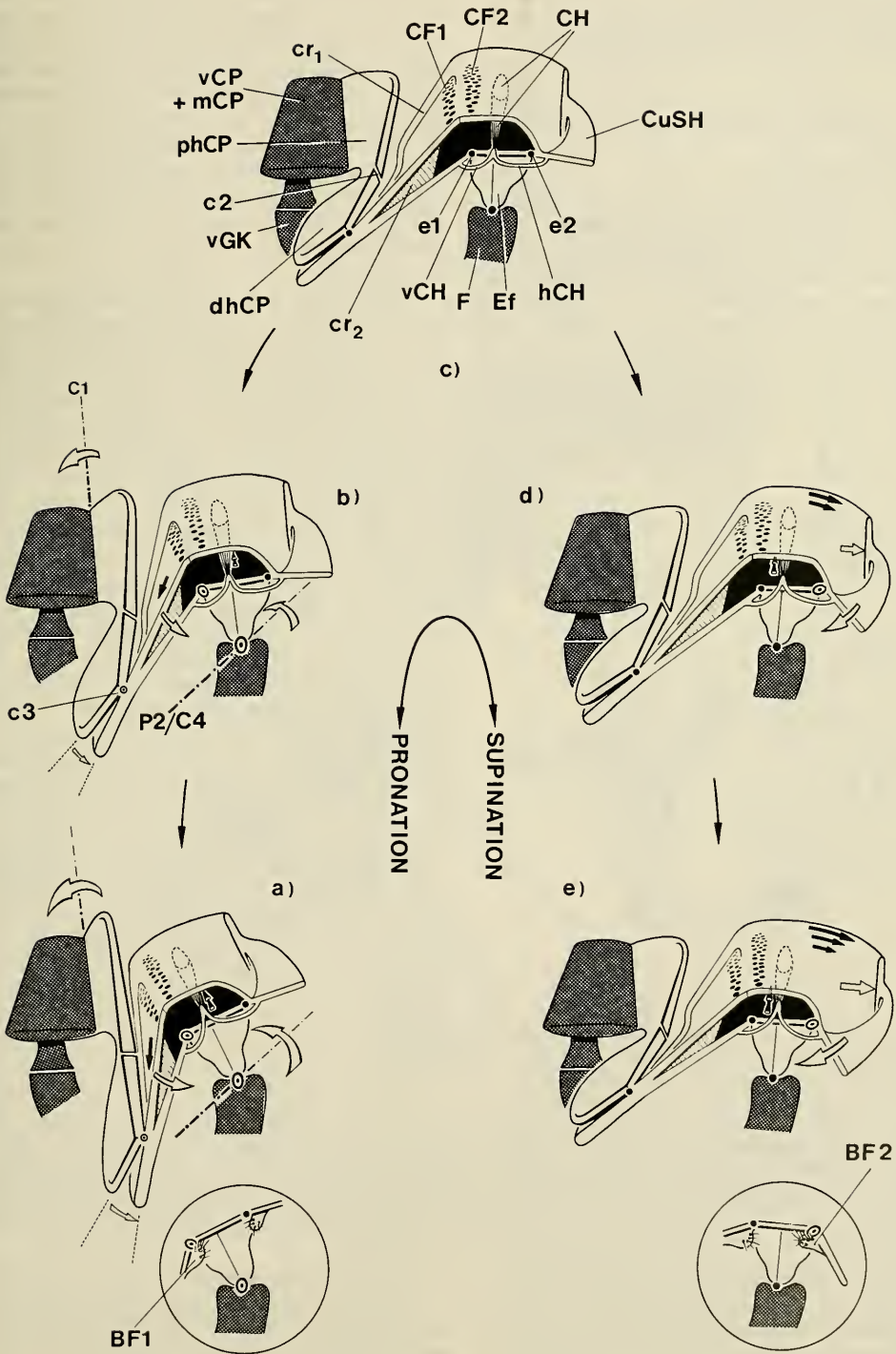



übrigen Haarsensillen die beim Anpressen am Epifulcrum stattfindende Verformung der Vorsprünge eine Rolle spielen könnte.

## ELEKTROPHYSIOLOGIE DER REZEPTOREN

### Material und Methode

Als Untersuchungstier wurde *Anax imperator* Leach gewählt, die größte einheimische Libelle, die bei uns im Juli und August an größeren Seen stellenweise noch häufig auftritt. Bei kleineren Arten, selbst bei Arten der Gattung *Aeshna* (die z.T. bis spät in den Herbst hinein zu fangen sind), erwies sich die Präparation als erheblich schwieriger. Da frisch geschlüpfte Li-

bellen für die Versuche nicht geeignet sind (sie sind weniger robust und fliegen auch schlecht), mußten adulte Exemplare jeweils kurz vor den Experimenten gefangen werden. Dabei handelte es sich meist um Männchen, seltener wurden auch Weibchen verwandt (Weibchen sind nur in geringer Zahl zu finden, haben aber den Vorzug, daß sie auch noch abends oder bei schlechterer Witterung fliegen). Von allen vier Flügeln wurde nacheinander abgeleitet — Vorder- und Hinterflügel zeigten dabei keine wesentlichen Unterschiede.

Libellen verhalten sich vor dem Windkanal sehr "launisch" und sind kaum zum Dauerflug zu bringen. Daher wurde zunächst nur vom nicht-schlagenden Flügel abgeleitet. Die Tiere wurden mittels Paraffin auf einer Unterlage fixiert und um etwa 30° (Kopf nach unten) gekippt, so daß die Terga des schräggestellten Pterothorax horizontal ausgerichtet waren (s. Abb. 16). Der waagrecht gestellte (in Schlagmitte befindliche) Flügel wurde wenig distal vom Nodus in die Klammer einer Drehapparatur eingelegt. Mit Hilfe dieser Vorrichtung konnte der Flügel um seine Längsachse gedreht werden — es wurde also die Bewegung imitiert, die als einzige zu einer deutlichen Beanspruchung der Mechanorezeptoren CH, CF1 und CF2 geführt hatte. Jenseits einer Winkelscheibe war die Drehachse mit einem linearen Wendelpotentiometer zur Registrierung des Reizes verbunden. In die dorsale Kutikula der Radioanalplatte wurde ein Fenster geschritten und der zwischen Tracheenwänden laufende (von den Tracheen "getragene") sensorische Flügelnerf freipräpariert. Zur Ableitung von Potentialen des CH mußte der zu diesem Organ führende Nervenast so nah wie möglich an der dorsalen Anheftungsstelle des CH (in der Abb. 16 punktiert) in den Haken einer Silberdrahtelektrode (40 µm Ø) gelegt werden<sup>1)</sup>. Dieser Nerv enthielt in einigen Fällen anscheinend dennoch Axone von (distalen) campaniformen Sensillen der Reihen CF1 oder CF2, die durch Ableitung und auch durch anschließende Präparation nachzuweisen waren (s. dazu auch S. 74). Bei den Ableitungen vom Feld CF1 bzw. CF2 lag die Haken-elektrode weiter proximal. Selbst bei Durchtrennung anderer Nervenäste (v.a. des zum CH



Abb. 15. Schema der Verformungen der kaudalen Radioanalplatte im Aufschlagsdrehbereich und der möglichen Übertragung von Kutikularspannungen auf das Sensillenfeld CF2. Blick auf die RAP eines rechten Flügels von *Aeshna*. Das kaudale Ansatzgebiet des Fulcralarmuskels (fa) ist über eine Zone besonders verstärkter Kutikula (z) an einem Längsfalz (f) der RAP "aufgehängt" (vgl. S. 54). Das dorsale Ansatzgebiet des Chordotonalorgans (CH) wird durch diesen Falz vermutlich gegen die pronatorischen (P) und supinatorischen (S) Bewegungen des fa-Ansatzgebietes "abgeschirmt"; weiter proximal werden Zug- bzw. Druckspannungen (angedeutet durch die schwarzen Pfeile) möglicherweise über die kaudale Media-Basis (kMB) auf die CF2-Sensillen übertragen.

<sup>1)</sup> Intrazelluläre Ableitungen sind dagegen problematisch, da die Radioanalplatte im Aufschlagsdrehbereich mitbewegt wird (vgl. S. 47ff.), was eine Verschiebung der Elektroden im Organ mit sich bringen würde.

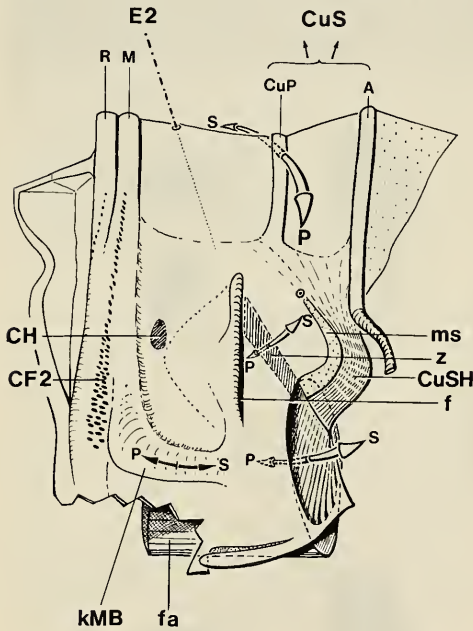

Abb. 16. Versuchsaufbau. *Anax imperator* um  $30^\circ$  gegenüber der Horizontalen ( $h$ ) gekippt, rechter Vorderflügel in mittlerer Anstellung ( $0^\circ$  = Anstellung zwischen den Drehbereichen) in der Drehklammer. In der herausvergrößerten, gefensterten  $RAP$  sind die freigelegten, zu den verschiedenen Sinnesorganen ( $CH$ ;  $CF1,2$ ;  $BF1,2$ ) führenden Nerven sichtbar; die  $RAP$  ist distal des Fensters durchsichtig gedacht, so daß das  $CH$ , mit samt den ventralen "Hebelementen", zu erkennen ist.  $p,s,P,S$  vgl. S. 71.

führenden Nerven) konnte jedoch in keinem Fall völlig sichergestellt werden, daß in den Ableitungen nur  $CF1$ - oder  $CF2$ -Sensillen enthalten waren, da der sensorische Flügelnerv (um Änderungen der Mechanik zu vermeiden) distal

von den Feldern nicht durchtrennt wurde. Die proximalen Borstenfelder  $BF1$  und  $BF2$  der Flügelunterseite (vgl. Abb. 7, 13, 14a, e und 17a) wurden nicht untersucht. Sie waren leicht vollständig auszuschalten: die Borsten beider

Felder wurden abrasiert und der Nerv des Feldes BF2 meist zusätzlich gekappt (der vom Feld BF1 kommende Nerv trifft weiter proximal auf den sensorischen Hauptnerv und war schon aus diesem Grund in den Ableitungen nicht enthalten). Über den Haken des Silberdrahts und den dort aufliegenden Nerven wurde zur Isolierung ein mit einer Paraffin-Vaseline-Mischung gefülltes, aus einem feinen Infusionsschlauch gezogenes Hütchen gestülpt (vgl. Möhl, 1979). Der Silberdraht mußte über eine Schleife an der Radius + Media-Doppelader festgewachst werden — nur auf diese Weise konnte eine Zerrung des Nerven (durch die Drehbewegung der Radioanalplatte im Abschlagsdrehbereich) vermieden werden. Die Potentiale wurden nach ihrer Verstärkung (Differenzverstärker Grass P16) auf dem Oszillographenschirm dargestellt

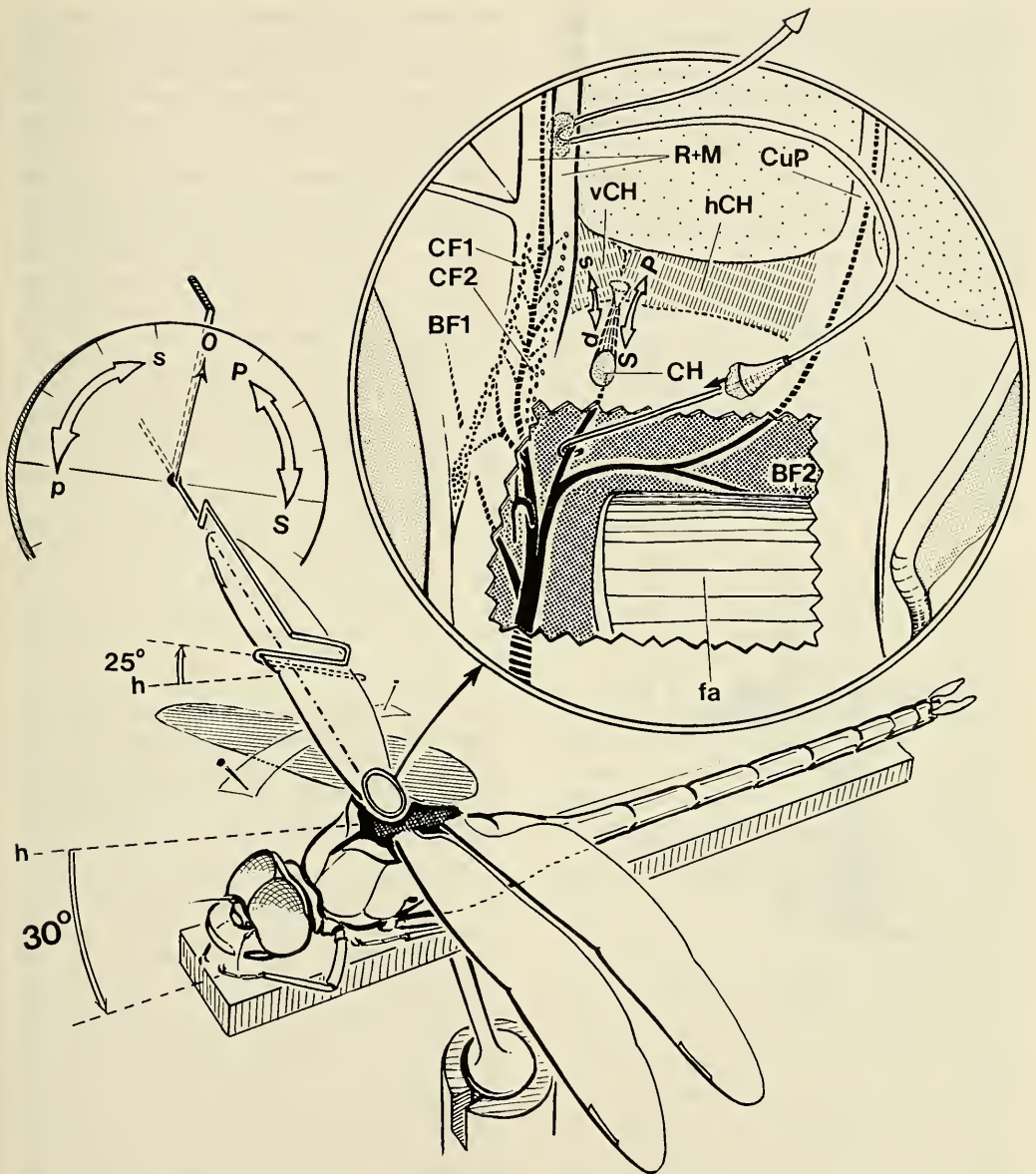
und mittels eines Schreibers (Physiopolygraph von Schwarzer) dokumentiert. Außerdem diente ein Lautsprecher der akustischen Kontrolle. In einigen Fällen wurde ein elektronisches Fenster zur alleinigen Darstellung der größeren Spikes eingesetzt.

Da die Klammer der Drehapparatur den Flügel nur auf einem schmalen Querschnitt ergreift und mitnimmt (Abb. 16), sind zur Reizung der proximal im Flügel liegenden Sinnesorgane CH, CF1 und CF2 weitaus größere Drehbewegungen erforderlich, als sie natürlicherweise beim Flug (auf der Höhe des Nodus) stattfinden (deshalb die großen Drehwinkel in den Abb. 18—21). Dennoch wird bei diesen weiten Drehungen proximal in der Radioanalplatte ein natürliches Maß anscheinend nicht überschritten; dies zeigt sich bei gleichzeitiger



Abb. 17. (a) Unterseite der RAP des aufgeschlagenen linken Vorderflügels von *Aeshna cyanea*. Das Bild zeigt den schrägen Verlauf der Gelenkachsen E1 und E2; das vertieft liegende Gelenk e1 der Achse E1 ist nicht sichtbar — am Gelenk e2 (nach Mazeraten gezeichnet) sind die Teile übertrieben weit getrennt. E1 und E2 treten auf der Dorsalseite des Flügels aus, bevor sie sich kreuzen (dabei steht E1 steiler → Austritt weiter proximal). Nur ein kurzes Stück des CH ist (am ventralen Ansatzpunkt) zu erkennen, dort, wo ein Teil der ventralen Membran entfernt ist. Die gestrichelten Doppelpfeile deuten die möglicherweise unterschiedlichen Bewegungsebenen (und das unterschiedliche Ausmaß der Bewegung) des ventralen CH-Ansatzes im Abschlags- und Aufschlagsdrehbereich an (vgl. S. 102). Die Pfeile an den Gelenken der CH-Hebelsklerite kennzeichnen die Schub-Punkte (bei Flügelverwindung) der R+M- bzw. CuP-Ader; beide liegen unterhalb der jeweiligen Epifulcrum-Gelenkachse. cf: 2 kleine Felder von campaniformen Sensillen in der Sc-Basis. Membran punktiert; (b) Eine direkte Messung der Länge des CH bei verschiedenen geometrischen Anstellungen des Flügels war noch nicht möglich. Das Schema zeigt eine (qualitative) Rekonstruktion der Umsetzung eines durch beide Drehbereiche gehenden äußeren Sinus-Drehreizes (oben) in Längenänderungen des CH (unten). Ausgezogene Linie: künstliche Flügeldrehung; gestrichelte Linie: durch elastische Kräfte modifizierter (naturgetreuer) Verlauf;  $l_{CH}$ : Länge des CH; Ab-Dr, Auf-Dr: Abschlags-, Aufschlagsdrehbereich;  $\alpha$ : geometrische Flügelanstellung. Vgl. S. 62ff. und S. 102f.



Beobachtung der auf der Flügelunterseite liegenden Gelenke der Radioanalplatte.

Eine wesentliche Frage ist, ob die erzeugten Reize sonst als angenähert physiologisch betrachtet werden können. Einerseits hatte sich ja ergeben, daß die beiden Drehbereiche unterschiedliche Drehachsen aufweisen, wobei eine der Achsen (und damit die im Raum verlaufende "eigentliche Drehachse") sich zudem noch während der Flügeldrehung in ihrer Ausrichtung verändert (s.S. 50); andererseits sind zumindest die passiven Kräfte kaum genau zu imitieren, da sie am ganzen Flügel angreifen und von proximal nach distal mit dem Quadrat der Umfangsgeschwindigkeit anwachsen. In dieser Hinsicht kann die verwendete Drehvorrichtung (mit ihrer konstanten Drehachse und nur schmalen Kontaktstelle der Drehklammer) sicher keinen naturgetreuen Reiz erbringen. Da künstlich erzeugte Flügelverwindungen aber sowohl von proximal wie von distal aus zu den auf S. 62ff. beschriebenen Beanspruchungen der Rezeptoren führen (die Ein- und Auswärtsbewegungen des CH-Ursprungs sind dabei leicht über einen Spiegel direkt zu beobachten), kann angenommen werden, daß die Unterschiede zu den natürlichen Beanspruchungen v.a. quantitativer Natur sind. Die auf der Flügelunterseite befindlichen Scharniergelenke e1 und e2 sorgen anscheinend dafür, daß Flügelverwindungen proximal stets in prinzipiell gleicher Weise ablaufen.

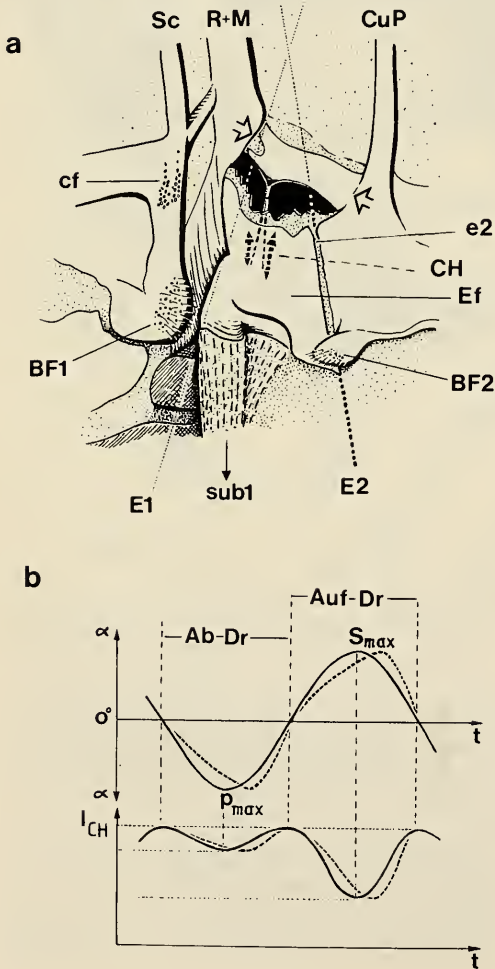
Weite Drehungen des Flügels, durch beide Drehbereiche hindurch, wie sie etwa in Abb. 18a, b dargestellt werden, finden bei fliegenden Libellen an den Schlagwendepunkten statt. Allerdings sind Pronation und Supination beim Flug natürlich jeweils durch eine Schlagphase voneinander getrennt. Pronation und Supination laufen außerdem sicher erheblich schneller ab. Um mit der Klammer der Drehapparatur entsprechend schnelle Drehungen (und Rezeptor-Reizungen) zu erreichen, müßte der Flügel im Versuch (infolge der oben beschriebenen Untersetzung vom Ort der Drehklammer zur Flügelbasis hin) mit einer Geschwindigkeit von schätzungsweise 10.000 bis 20.000 Grad/Sekunde gedreht werden. Da dies technisch im Moment kaum zu lösen ist, wurden zunächst nur manuelle, relativ langsame Drehreize gegeben.

#### Ableitungen vom Flügel-Chordotonalorgan

Die Ableitungen, bei denen vom Nerv des Chordotonalorgans, dicht beim dorsalen Austrittsort aus dem Organ (Abb. 16), abgeleitet

wurde, können (abgesehen von den Einzelfällen, die auf S. 73 beschrieben werden) als reine CH-Ableitungen betrachtet werden. Sie stellen, wie auch fast alle anderen Ableitungen, Summenableitungen dar.

In den Abb. 18a und b werden manuelle Sinusdrehungen durch beide Drehbereiche wiedergegeben. Die Drehrichtungen innerhalb der Drehbereiche sind (in Abb. 18a) in der oben dargestellten Reizspur durch die Buchstaben p und s (Pronation bzw. Supination im Abschlagsdrehbereich) und S und P (Supination bzw. Pronation im Aufschlagsdrehbereich) gekennzeichnet (vgl. auch Abb. 16). Auf der Winkelskala am Bildrand, welche die Stellung der Drehklammer auf der Höhe des Nodus wiedergibt (Abstand zwischen den Teilstrichen 50°), stehen  $p_{max}$  und  $S_{max}$  für extrem pronierte bzw. supinierte Anstellungen im Abschlags- bzw. Aufschlagsdrehbereich.

Die Abb. 18a und b zeigen mehr oder weniger dichte Spike-Ansammlungen, die zwischen den extremen Flügelanstellungen auftreten. Da der Flügel bei Pronation (p,P) und Supination (S,s) jeweils die 0°-Anstellung durchläuft (wobei die direkte Beobachtung der Flügelunterseite zeigt, daß das ventrale Ursprungsgebiet des CH in der 0°-Anstellung maximal aus der Radioanalplatte herausbewegt ist), treten die Impulse offensichtlich da gehäuft auf, wo der Rezeptor stark gedehnt ist (vgl. Abb. 14, 17b und S. 63f.). Der Flügel ist bei 0° (der Anstellung maximaler CH-Dehnung) auf der Höhe des Nodus ungefähr 25° gegenüber der Horizontalen supiniert; das bedeutet, daß der 0° entsprechende geometrische Anstellwinkel bei einem horizontal ausgerichteten Tier etwa 55° Supination betragen würde (vgl. S. 68 und Abb. 16).

Die CH-"Bursts" sind aus Spikes unterschiedlicher Höhe zusammengesetzt, stammen also von verschiedenen Einzelsensillen. Das von Reiz zu Reiz sich ändernde äußere Impulsbild deutet darauf hin, daß das Organ die Unregelmäßigkeiten des manuellen Reizes wiedergibt. Stärker beschleunigte Drehungen (etwa die erste Pronation der Abb. 18a) weisen z.B. besonders kurze, dichte Impulsansammlungen auf. Bei langsamen Drehungen sind die CH-Spikes dagegen über den ganzen Drehspielraum ( $S_{max}$ - $p_{max}$  und zurück) verteilt — die Anhäufung um 0° herum ist weniger deutlich (Abb. 18b). Bei Treppen-Reizen durch beide Drehbereiche gibt das CH auf jeder Reizstufe Potentiale ab (Abb. 18c); es wird demnach in beiden Drehbereichen sowohl bei Pronation als auch



Abb. 18. (a-e) Ableitungen vom Chordotonalorgan von *Anax imperator* bei manueller Flügeldrehung um die Längsachse. Impulse nachgezeichnet. In e wurde der Beginn der (sehr geringfügigen) Reize durch Pfeile markiert.

bei Supination gereizt. In den Extreimbereichen ( $p_{\max}$  bzw.  $S_{\max}$  auf der Winkelskala) sind die Antworten etwas schwächer oder können auch ganz fehlen. Auffällig ist, daß die Impulse entweder über die ganze Länge der einzelnen Reizrampen verteilt sind oder nur am Beginn und Ende abgegeben werden (vgl. auch Abb. 19b). Um  $0^\circ$  ist das CH anscheinend besonders empfindlich (Abb. 18d, e): Hier feuern Sensillen noch bei besonders geringfügigen und langsamen Drehungen des Flügels. In der Abb. 18e wurde der Flügel z.B. nur etwa  $5^\circ$  weit gedreht; diese Winkeländerung wird zur Flügelbasis hin noch beträchtlich herabgesetzt und ist dort un-

ter dem Binokular nicht mehr als Bewegung des CH-Ansatzes zu erkennen (in diesem Fall war daher nicht zu entscheiden, in welcher Weise Dehnung und Entdehnung des Rezeptors aufeinander folgten).

Ableitungen von anderen Rezeptoren, wahrscheinlich campaniformen Sensillen

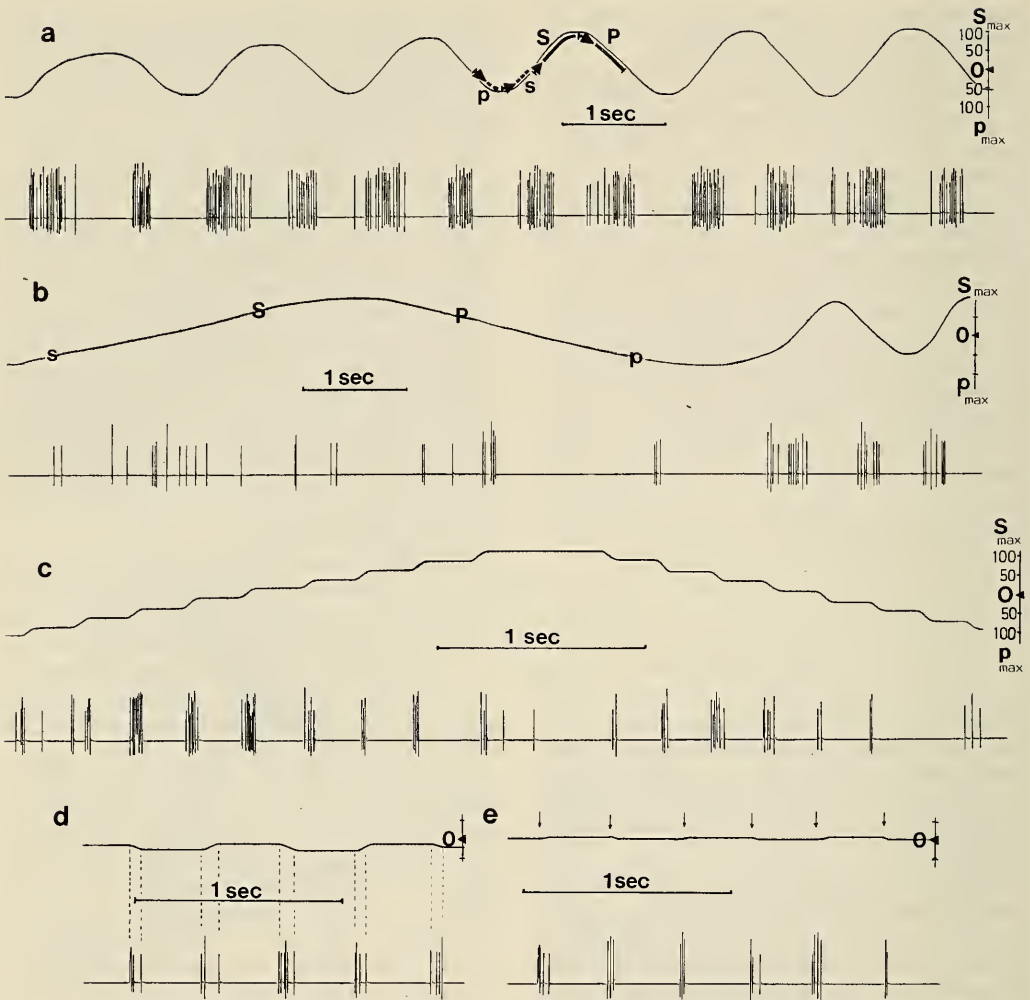
Die folgenden Ableitungen stellen Einzelbeobachtungen dar und werden vorerst entweder distalen bis mittleren Sensillen des CF2-Feldes oder CF1-Sensillen zugeschrieben. Die Argumente dafür werden weiter unten zusammengefaßt.

Bei zwei Ableitungen (von verschiedenen Tieren), bei welchen ebenfalls weit distal, vom Nerv des Chordotonalorgans, abgeleitet wurde (die Hakenelektrode lag etwa wie in der Abb. 16 dargestellt), feuerten bei Supination, in der Nähe von  $S_{\max}$ , Sensillen mit einem von den CH-Sensillen abweichenden Zeitverhalten (Abb. 19). Sie waren im Lautsprecher deutlich von den in der selben Ableitung auftretenden, mehr unregelmäßigen ("stotternden") Impulsmustern der stark phasischen CH-Sensillen zu unterscheiden: bei Sinusreizen bildeten sie dichte Bursts mit z.T. sehr regelmäßiger Folge der Einzelpulse, die mit dem Beginn der Rückdrehung (P) endeten (Abb. 19a, c)<sup>1)</sup>. Treppenreizungen zeigten, daß diese Sensillen zu Beginn jeder Reizstufe neu erregt wurden und jeweils mit einer hohen Anfangsfrequenz feuerten (Abb. 19b). Die Erregung ging bei längeren Intervallen zwischen den Reiztreppen oder zwischen der S- und P-Drehung relativ schnell auf Null zurück (vgl. Abb. 19b, 2. Ableitung, und 19d). Bei Sinusreizen kam der Erregungsabfall der Einzelsensillen dagegen nicht zum Ausdruck, so daß die Impulse dort ohne Lücke bis zum Beginn der P-Drehung aneinander angeschlossen. Offensichtlich folgten dabei mehrere, verschiedene Sensillen dicht aufeinander (vgl. Abb. 19c, d). Das unterschiedliche äußere Impulsbild dieser Rezeptoren bei den Sinusreizen erklärt sich wohl v.a. aus den unterschiedlichen Dreh-Amplituden und -Geschwindigkeiten. In der Abb. 19d ist z.B. zu erkennen, daß ein einzelnes Sensillum in Abhängigkeit von der Drehamplitude (und Geschwindigkeit?) verschieden stark erregt wurde. Bei Drehungen höherer Geschwindigkeit zeigten die Ableitungen dichtere, bei gleicher Drehamplitude zwangsläufig kürzere Bursts (Abb. 19c). Der Beginn der Bursts hängt anscheinend wesentlich vom Ausgangswinkel der Drehung ab: ging der nächste Drehreiz z.B. von einem größeren geometrischen Anstellwinkel (näher bei  $S_{\max}$ ) aus, so verschob sich der Erregungsbeginn zu einem größeren Winkel hin (auch dann, wenn schon früh eine dem vorigen Reiz entsprechende Drehgeschwindigkeit erreicht wurde; Abb. 19d, e). Diese Einzelbefunde sprechen dafür, daß der Gesamtverlauf des Reizes (d.h. sowohl Anfang und Ende als auch Geschwindigkeit der Dre-

hung) für die Erregung der Sensillen von Bedeutung ist (vgl. dazu auch S. 103f.).

Von ganz ähnlichen Sensillen (mit entsprechendem Zeitverhalten) konnte auch bei Pronationsdrehungen im Abschlagsdrehbereich, in der Nähe von  $P_{\max}$ , abgeleitet werden (nicht abgebildet). Auch hier feuerten die Sensillen nur bei Drehung in Richtung Anstellxtrem und endeten bei Beginn der Rückbewegung (in diesem Fall dem Beginn der s-Drehung).

In einigen Fällen wurde weiter proximal vom sensorischen Flügelnerve abgeleitet; die Hakenelektrode befand sich dabei vor der Aufgabellung des Haupt-Nervenstammes in die zu den verschiedenen Rezeptorfeldern führenden Äste (jedoch distal von der Abzweigung des zum Feld BF1 führenden Nerven). Auch hier traten Sensillen mit einem mehr phasisch-tonischen Zeitverhalten auf. Bei gleichmäßiger und langsamer pronatorischer Drehung durch den Abschlagsdrehbereich stieg die Impulszahl/Sekunde von  $0^\circ$  an allmählich an, wobei die im Zeitverlauf unterschiedlichen Spikegrößen auf ein sukzessives Ansprechen immer neuer Sensillen hinweisen (Abb. 20a). Stufenreize zeigten, daß bestimmten Flügelanstellwinkeln im Abschlagsdrehbereich bestimmte Summen-erregungszustände zugeordnet sind (Abb. 20b). Bei dieser Ableitung wurde der Flügel jeweils um  $30^\circ$  weiter proniert, dann wurde eine Sekunde gewartet und aufgezeichnet. Die Erregung blieb auf jeder Stufe über mehrere Sekunden relativ konstant; nur bei  $60^\circ$  und  $90^\circ$  sieht man in der zweiten Hälfte der Ableitung einen geringen Erregungsabfall (möglicherweise ein Hinweis darauf, daß die distalen Sensillen der Felder schneller adaptieren; vgl. auch Abb. 19b, d und weiter unten). Von ähnlichen, "phasisch-tonischen" Sensillen konnte auch bei supinatorischen Drehungen im Aufschlagsdrehbereich (S) abgeleitet werden — hier jedoch nicht ab  $0^\circ$ , sondern erst ab  $50^\circ$  (s. Abb. 21 und weiter unten).

Alle diese vom Erregungsmuster der stark phasischen CH-Sensillen abweichenden Ableitungen werden vorerst campaniformen Sensillen zugesprochen. Während die auf Pronation ansprechenden Sensillen des Abschlagsdrehbereichs als proximale bis distale Sensillen des Feldes CF1 angesehen werden können, stammen die bei Supination im Aufschlagsdrehbereich abgeleiteten Impulse wohl von mittleren bis distalen CF2-Sensillen (von distalen Sensillen in den Fällen, in denen scheinbar allein vom CH-Nerv abgeleitet wurde). Für diese Interpreta-

<sup>1)</sup> Nur bei über den Bereich der ableitbaren Sensillen hinausgehenden (oder auch bei unphysiologisch weiten) Drehreizen endeten die Bursts schon vor dem Beginn der P-Drehung.



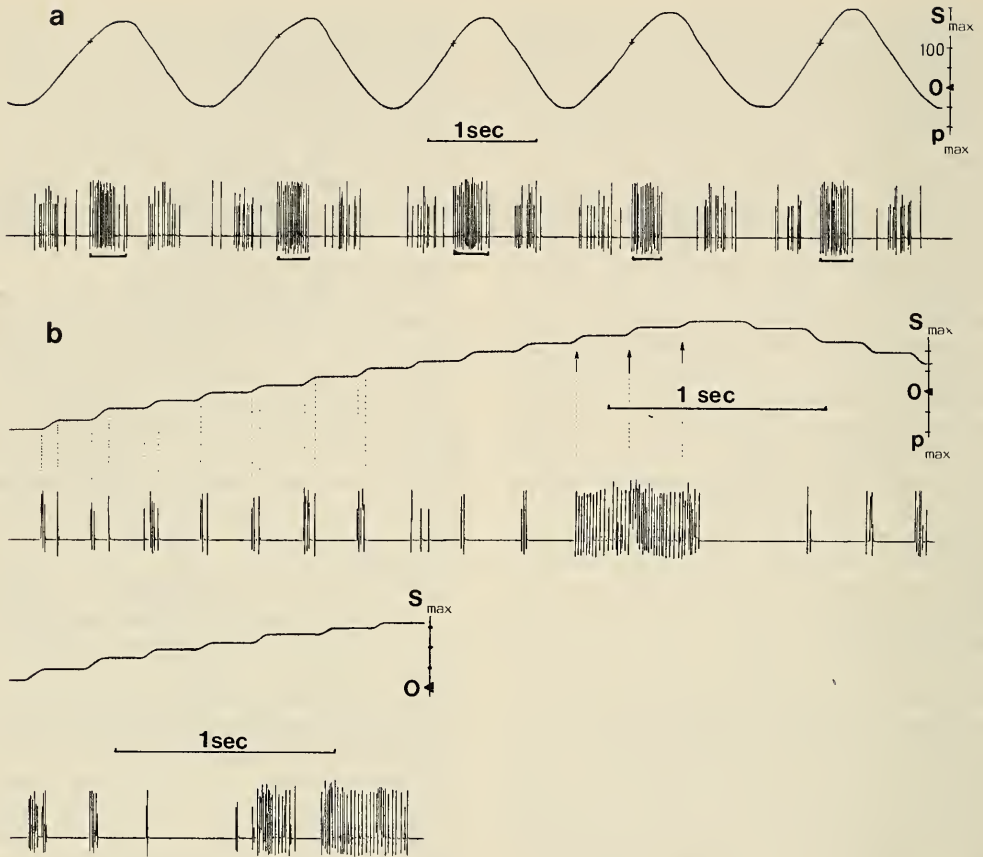

tion spricht folgendes: 1) Die mechanische Beanspruchung der Sensillengebiete (S. 64ff.) weist darauf hin, daß in der Kutikula Zugspannungen in der Längsrichtung der Kutikulargruben auftreten — entweder bei Pronation im Abschlagsdrehbereich (CF1) oder bei Supination im Aufschlagsdrehbereich (CF2) —, die von proximal nach distal fortschreiten (vgl. auch Abb. 14 und 15). Diese verursachen wahrscheinlich — über Druckspannungen senkrecht zur Grubenlängsachse und Deformationen der Dendriten-Tubularkörper (vgl. z.B. Zill & Moran, 1981) — eine sukzessive Reizung der aufeinanderfolgenden Sensillen. 2) Die "typischen" Ableitungen vom CH stellen stark phasische Antworten dar, die v.a. im mittleren Anstellbereich (um  $0^\circ$ ), also bei stärker gedehntem Rezeptor, auftraten; diese Sensillen wurden in beiden Drehrichtungen erregt. Die Sensillen mit dem abweichenden (phasisch-tonischen) Zeit-

verhalten traten dagegen in beiden Drehbereichen jeweils nur in einer Richtung, nämlich zum Anstellextrem hin, auf; in dieser Richtung wird das CH zunehmend entspannt und reagiert immer schwächer. 3) In den Fällen, in denen vom CH-Nerv allein abgeleitet wurde und dennoch Sensillen mit phasisch-tonischem Zeitverhalten feuerten (s.S. 73), konnte bei anschließender Präparation gezeigt werden, daß von distalen CF2- (bzw. CF1-) Sensillen stammende Nerven an den Nerv des CH angeschlossen waren. (Das Verzweigungsmuster erwies sich überhaupt als äußerst variabel: die Axone der einzelnen Sensillen der campaniformen Sensillengebiete sind keineswegs immer streng gebündelt, sondern nehmen z.T. "Umwege"; so können CF2-Nervenäste z.B. auch an den BF1-Nerv anschließen.) Anscheinend wurden gerade diese Sensillen — der Erwartung entsprechend in den extremen Anstellbereichen — erregt. 4) Das se-



Abb. 19. (a-f) Gemischte Ableitungen vom Chordotonalorgan und (vermutlich) distalen Sensillen des Feldes CF2. In (a) und (c) sind die CF2-Bursts durch Balken gekennzeichnet (in der Reizspur steht in (a) am Winkelort ihres Beginns ein x); in (e) ist der Drehabschnitt mit CF2-Impulsen in der Reizspur verdickt wiedergegeben. Vgl. S. 72f. In (f) sind neben CF2-Sensillen (die durch Punkte unter der Ableitspur gekennzeichnet wurden) verschiedene, bestimmten Winkelabschnitten der Drehung zugeordnete CH-Impulse ( $\uparrow$ ,  $\cup$ ) zu sehen (s. dazu S. 102).

rielle, dichte Aufeinanderfolgen der Potentiale der Sensillen entspricht ihrer Reihenanzordnung. Zeitlich spätere (jeweils bei größeren geometrischen Anstellwinkeln auftretende) Antworten können anscheinend weiter distal liegenden Sensillen zugeordnet werden (s. oben). Bei weit proximal angelegter Elektrode zeigten von  $0^\circ$  ausgehende Supinationsdrehungen allerdings nie von Beginn an Impulse, d.h., die basalen CF2-Sensillen fehlten immer. Dieser Teil des CF2-Feldes mußte durch die Präparation (im Gegensatz zum Feld CF1) stärker beschädigt

werden (vgl. Abb. 16)! 5) Andere Rezeptoren, die ebenfalls mit den Flügeldrehungen in einer Beziehung stehen könnten (BF1, BF2; vgl. S. 66ff.), waren ausgeschaltet (s.S. 69f.).

### 3. EVOLUTION DER FLUGAPPARATE DER ODONATEN, EPHEMEROPTEREN UND NEOPTEREN

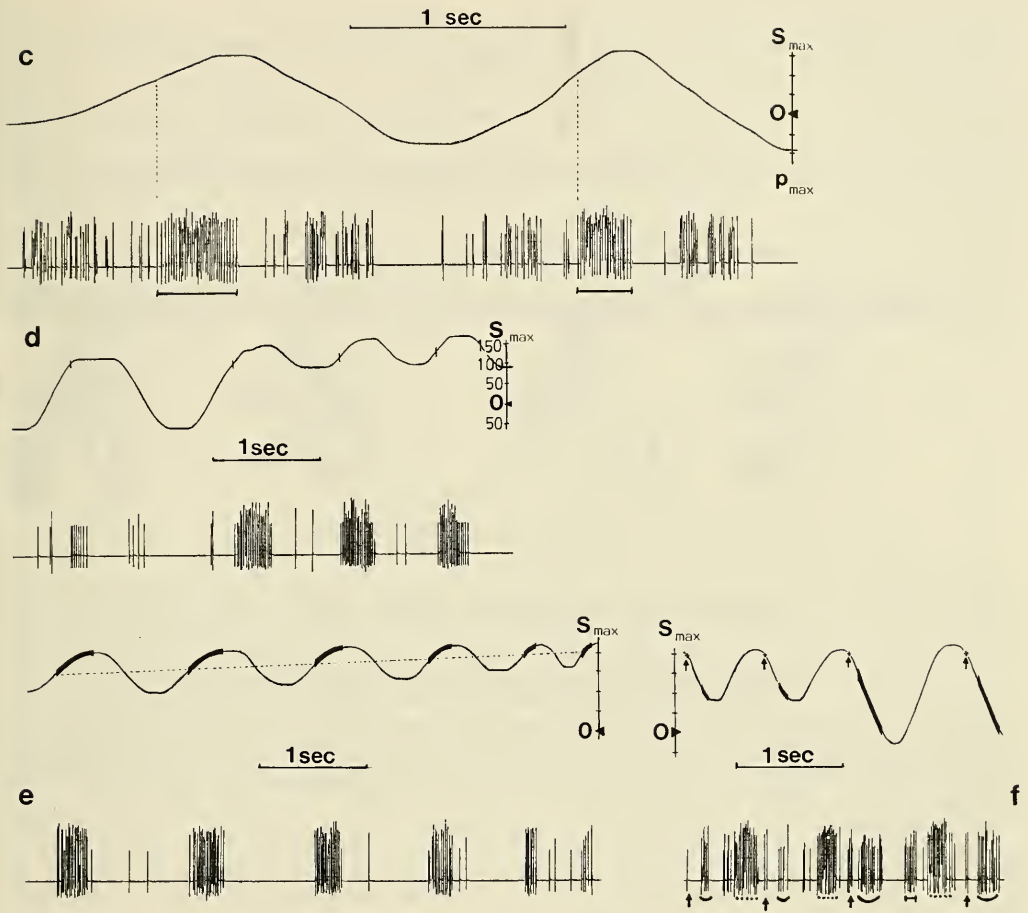
In diesem Kapitel soll auf einige Aspekte der Evolution der verschiedenen Flugmechanismen der Pterygoten eingegangen werden. Aufgrund



Abb. 20. (a) Allmähliche Pronation im Abschlagsdrehbereich (untere Spur; 0°-Linie gestrichelt mitgeführt) und Ableitung von (diesem Drehbereich zugeordneten) Sensillen des Feldes CF1 (vgl. S. 73); (b) Ableitung von entsprechenden Sensillen wie in (a) bei unterschiedlichen (statischen) Flügelanstellungen im Abschlagsdrehbereich (vgl. S. 73).



Abb. 21. Ableitungen, die mittleren bis distalen Sensillen des Feldes CF2 zugeordnet werden; Supinationsdrehungen des Flügels im Aufschlagsdrehbereich (vgl. S. 73ff.).

der fast ganz fehlenden Fossilüberlieferung und der Notwendigkeit, von gut gesicherten monophyletischen Gruppen auszugehen, muß dabei v.a. ein Vergleich der rezenten Gruppen zugrunde gelegt werden (s. dazu die grundsätzlichen Überlegungen von Hennig, 1969)<sup>1)</sup>. Da

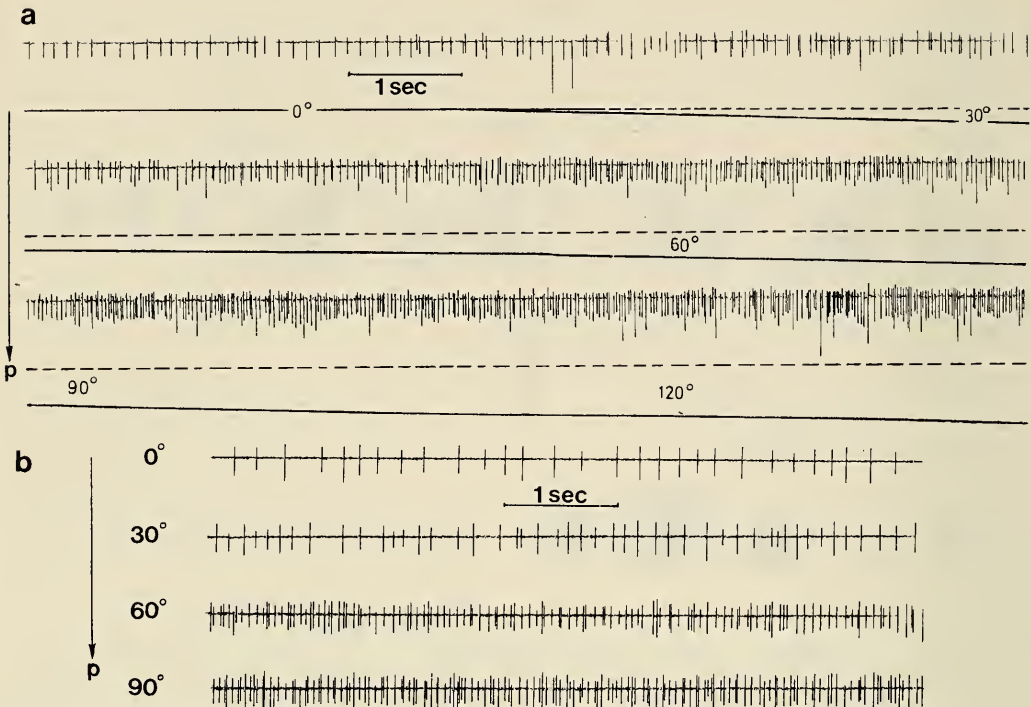
<sup>1)</sup> Hennig (1969, l.c. S. 34) führte für Gruppenbezeichnungen eine sehr wesentliche Präzisierung ein: er kennzeichnet diejenigen Gruppen mit einem Sternchen (z.B. \*Trichoptera), die auf den letzten gemeinsamen Vorfahren aller rezenten Arten zurückgehen und unterscheidet sie von Gruppen ohne \*, die auch die fossilen sog. "Stammgruppen"



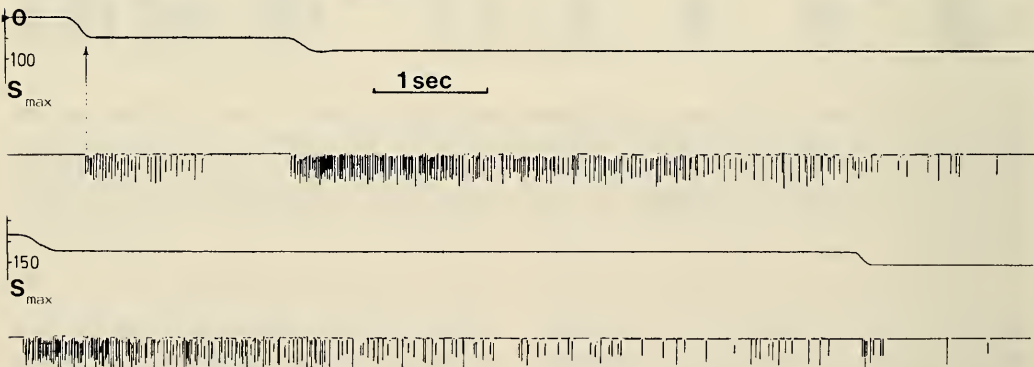

Abb. 22. Unterschiedliche Pronations-Supinations-Mechanismen bei Neopteren. Flügel in supinierter Anstellung gezeichnet. Der dick schraffierte Basisabschnitt bildet bei einer Verwindung des Flügels jeweils das Widerlager; beim Flügelschlag werden die thorakalen Antriebskräfte über diesen Teil auf den "Verstellflügel" (weit schraffiert) übertragen. Lage der Drehachse des Flügels gestrichelt angedeutet. Die Pfeile in den Muskeln deuten eine Funktion beim Aufschlag (Pfeilspitze nach oben) oder Abschlag (Pfeilspitze nach unten) an; dabei wird eine zugfederartige Wirkung der wohl tonisch-aktiven Muskeln angenommen (Ausnahme: die phasischen Basalar- und Subalarmuskeln von *Locusta* und der sub1 von *Cetonia*). Pronatoren dunkel (eng punktiert), Supinatoren hell (weit punktiert). Nur der Muskel pt3 (M85) von *Locusta* wirkt in den beiden Schlagphasen unterschiedlich, beim Abschlag supinierend, beim Aufschlag pronierend, jeweils entgegengesetzt zu der den Flügel passiv drehenden Luftanströmung (wobei die Drehwirkung beim Abschlag vermutlich noch durch eine hinzukommende "Zugfeder-Wirkung" verstärkt wird). bas Basalarmuskeln; sub Subalarmuskeln; pt3 Pterale-3-Muskeln; pt4 Pterale-4-Muskeln; ts Tergosternalmuskel; die tiefgesetzten Zahlen sollen keine Homologievorstellung ausdrücken. Die Muskeln für Schlagbahnveränderungen (weitere Pterale-3-Muskeln und Basalarmuskeln bei *Apis* und *Calliphora*) wurden weggelassen. Vgl. Pfau, 1977b, 1978a; Pfau & Honomichl, 1979; Pfau, 1977a und in Vorb.

unsere Kenntnis über die Funktionsweise der rezenten Flugapparate jedoch immer noch sehr lückenhaft ist, ist diese Basis sehr schmal. So muß der Vergleich hier weitgehend auf den Flügelantrieb beschränkt bleiben; eine synthetische Theorie, welche die Flügel-Stellfunktionen mit einbezieht, ist vorerst höchstens in Umrissen möglich. Dies hängt auch damit zusammen, daß innerhalb der großen Gruppe der Neoptera sehr unterschiedliche Flügelstellmechanismen verwirklicht sind: So hat sich z.B. gezeigt, daß die Drehbewegungen des Flügels um die Längs-

achse bei Orthopteren, Coleopteren, Hymenopteren und Dipteren in ihrer Mechanik größere Unterschiede aufweisen, und daß in diesen Gruppen z.T. nicht-homologe pronatorische bzw. supinatorische Muskeln eingesetzt werden (Abb. 22; vgl. auch Pfau, 1977a, b; Pfau & Honomichl, 1979). Entsprechendes trifft für die Muskulatur und Mechanik der Flügelschlagbahnänderungen zu (eigene, nicht veröffentlichte Untersuchungen). Der Grundplan der an der Basis der Neoptera vorhandenen Stellmechanismen muß also erst noch rekonstruiert werden. Da selbst innerhalb einzelner Ordnungen der Neoptera keine Einheitlichkeit besteht, müßten zunächst für diese Gruppen genauere vergleichende Bearbeitungen und Grundplanrekonstruktionen erfolgen.

Die im weiteren vorgenommene Rekonstruktion einiger wesentlicher Teile des Ur-Flugapparates der Insekten, und ihrer Abwandlungen

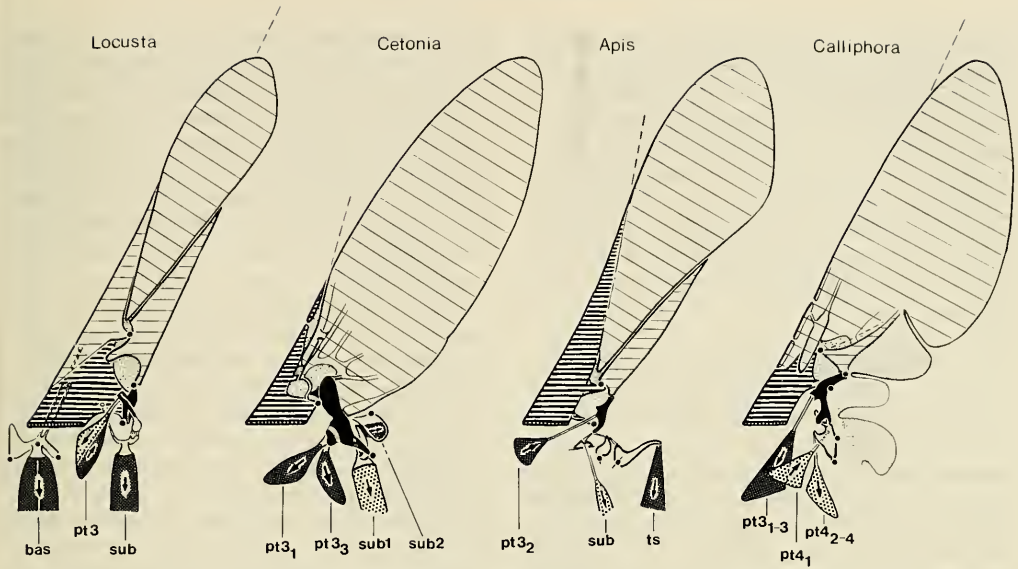
enthalten. In der vorliegenden Arbeit handelt es sich in der Regel um \*Gruppen; nur an einigen Stellen, an denen ich ein Mißverständnis auf jeden Fall vermeiden möchte, wird entweder ein \* angefügt oder ausdrücklich vermerkt, daß Gruppen im weiteren Sinne (d.h. incl. Stammgruppe) gemeint sind.

auf dem Weg zu den rezenten Gruppen, ist ein Versuch, die z.T. großen Lücken zwischen den rezenten Flugapparat-Typen zu schließen. Er muß weitgehend hypothetisch bleiben. Wenn hier dennoch an verschiedenen Stellen bis in Einzelheiten gegangen wird, so v.a. deshalb, um aufzuzeigen, daß die These eines polyphyletischen Ursprungs des Insektenflugs (Matsuda, 1981) keineswegs zwingend ist (sie geht außerdem von einigen falschen Voraussetzungen aus vgl. dazu auch S. 105ff.).

#### Der ursprüngliche Antriebsmechanismus der Pterygoten

Bei den drei rezent existierenden Hauptgruppen der Pterygoten, den Odonaten, Ephemeropteren und Neopteren, sind zwei verschiedene Antriebs-Grundprinzipien verwirklicht. Sie sollen hier (schlagwortartig) als "Tergalplatten-Mechanismus" TPM (Odonata) und "Tergalwölbungs-Mechanismus" TWM (Ephemeroptera, Neoptera) bezeichnet werden.

Der TPM ist dadurch gekennzeichnet, daß das Tergum beim Flügelschlag als Ganzes auf-

und abbewegt wird (Abb. 24b) und die Flügelbasis demzufolge über eine längere Strecke (bzw. über mehrere Gelenkstellen) scharnierartig mit dem Tergum artikuliert. Als antagonistische Antriebsmuskeln existieren indirekte Heber (am Tergum ansetzende Dorsoventralmuskeln, die primär wohl über die ganze Breite des Schlaggelenks verteilt waren) und direkte, am Flügel ansetzende Senker ("Basalar-" und "Subalarmuskeln").

Der TWM führt dagegen über eine Aufwölbung und Abflachung des Tergum zum Ab- und Aufschlag, wobei der Flügel nur durch einen Teil des Tergalrandes, den hauptsächlich auf- und abbewegten mittleren bis hinteren Bereich, gehiebelt wird (Abb. 23 und 24c, d). Membranöse seitliche Einschnitte im Tergum (Tergalspalte) verbessern die Verwölbbarkeit des Tergum und somit seine Hebelwirkung — sie konzentrieren sie auf einen relativ kurzen Abschnitt der Flügelbasis. Als Hauptmuskeln des TWM fungieren am Tergum ansetzende Dorsoventralmuskeln (indirekte Heber) und dorsale, rein tergale Längsmuskeln (indirekte



Abb. 23. Das Wirkungsprinzip des Tergalwölbungs-Mechanismus (TWM) kann nur in einer Seitenansicht des Thorax verdeutlicht werden. Tergum und Sternum punktiert, Pleuralleiste schwarz hervorgehoben. Nur die indirekten Muskeln wurden eingezeichnet.

Senker). Außerdem können phasische direkte Senker als Synergisten der dorsalen Längsmuskeln beteiligt sein (mit deutlicher Abschlagswirkung v.a. dann, wenn sie in ihrer Zugrichtung mit den Dorsoventralmuskeln übereinstimmen, und wenn ihr Zugpunkt am Flügel der tergalen Hebelstelle genähert ist); sie haben jedoch meist zusätzliche Funktionen als Stellmuskeln und sind in abgeleiteten Gruppen (etwa Dipteren) auch zu reinen (tonischen) Stellmuskeln geworden.

Das hier als TWM bezeichnete Antriebsprinzip wird in der Literatur (vgl. etwa Hadorn & Wehner, 1974; Seifert, 1975) häufig falsch dargestellt. So wird z.B. die Aufwölbung des Tergum durch die dorsalen Längsmuskeln, die in der Tierlängsrichtung geschehen muß (vgl. Abb. 23 und 24d), in eine Querschnittsebene des Thorax verlegt (s. z.B. Seifert, 1975, Abb. 148); eine zunehmende Quer-Verwölbung des Tergum würde aber dem Abschlag (den sie bewirken soll) sogar entgegenarbeiten und ist außerdem kaum durch eine Kontraktion der Längsmuskeln zu bewerkstelligen. Es ist auch nicht korrekt, wenn man den Mechanismus des Flügelschlags der Insekten als "Deckel-Topf-Mechanismus" darstellt und verallgemeinert, da dieses Prinzip eigentlich nur bei den Odonaten (als TPM) verwirklicht ist. V.a. bei stark spezialisierten Gruppen, die den Flügel über einen kaudalen "Scutellarhebel" antreiben (Dipteren, Hymenopteren, Ephemeropteren), spielt eine "Deckel-gegen-Topf"-Bewegung für den Flügelschlag keine Rolle mehr: die Bewegung der Scutellarhebel wird hier durch eine komplizierte Verformung des Tergum und der Pleuren (d.h. fast des gesamten Thorax!) bewirkt.

Da die indirekten Senker (dlm) und Heber (dvm) und die direkten Senker (bas, sub) in allen Pterygoten-Hauptgruppen vorhanden und am Flügelantrieb beteiligt sind (im Falle des dlm der Odonata kann auf eine ursprüngliche Abschlagsfunktion geschlossen werden; s.S. 61), kann davon ausgegangen werden, daß diese Muskeln auch bei der Ahnform der \*Pterygota als Flügelantriebsmuskeln vorhanden waren<sup>1</sup>). Das wiederum könnte bedeuten, daß primär ein Schlagmechanismus existierte, der sich noch beider Möglichkeiten bediente, also sowohl das

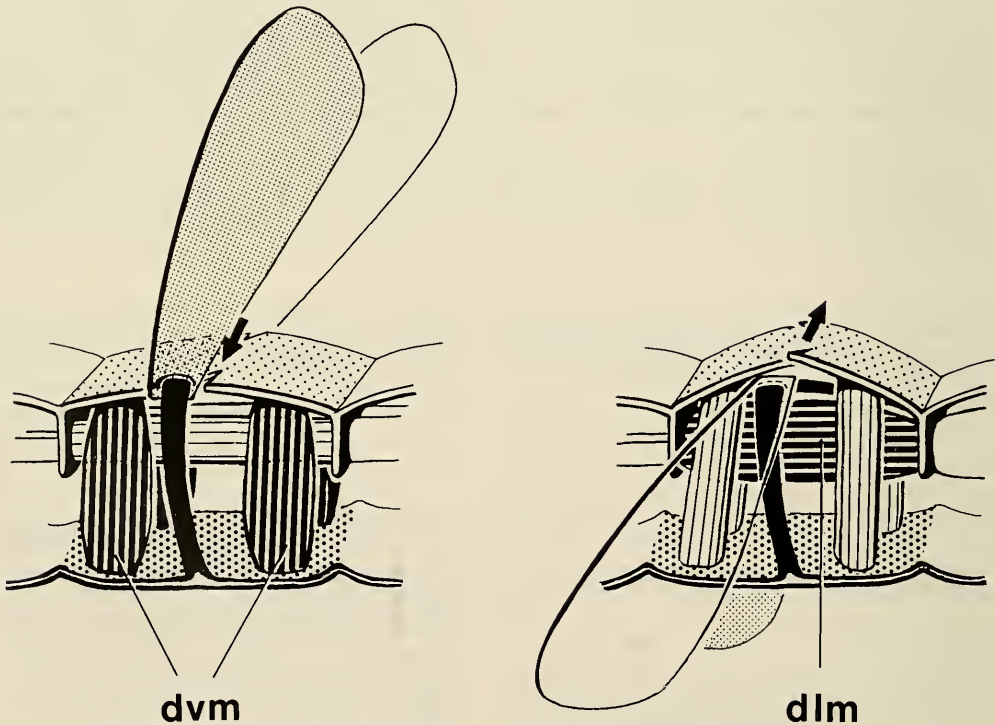
TPM- als auch das TWM-Prinzip nutzte. Die Funktionsfähigkeit eines solchen Ur-Flugapparates ("TPM + TWM", Abb. 24a), der, wie sich im weiteren zeigen soll, eine relativ zwanglose Ableitung der (effizienteren) rezenten Flügelantriebsmechanismen erlaubt, setzt bestimmte Konstruktionsmerkmale voraus: So muß z.B. sowohl der TPM- als auch der TWM-Antriebsanteil über ein eigenes Schlaggelenk und eine eigene Schlagachse verfügt haben; in der Abb. 24a wurden daher zwei pleurale Flügelgelenke, a und b, und zwei Schlagachsen (A/B und B) eingezeichnet. Da das Tergum auf der Höhe des (etwa in der Flügelmitte liegenden) Gelenkes b beim Flug stärker auf- und abbewegt wird als weiter vorn, auf der Höhe von a (s. Pfeile in Abb. 24a), ist zusätzlich die Annahme einer innerhalb der Flügelbasis verlaufenden, schrägen Gelenkzone notwendig. Sie trennt einen vorderen, basalen Teil des Flügels, den "Basis-Sklerit" (BAS), vom restlichen Flügel. Vorn sitzt dieser Sklerit dem vorderen pleuralen Gelenkkopf auf (und bildet das Gelenk a), hinten besitzt er — an der Stelle e, dicht beim hinteren Schlaggelenk b — eine zweite gelenkige Kontaktstelle zum Pleurum. Eine solche Gelenk- und Achsenanordnung erlaubt es, daß beide Antriebsmechanismen (TPM: Bewegung des ganzen Flügels um A/B — TWM: Bewegung des distal von BAS liegenden Flügelabschnittes um B) gemeinsam und auch relativ gleichwertig an der Flügelschlagbewegung beteiligt sein können (würde z.B. der Sklerit BAS an anderer Stelle artikulieren — etwa bei e' oder e", vgl. Abb. 24b und d —, so würde dies entweder den TWM- oder den TPM-Antriebsanteil in seiner Effektivität schwächen; s. dazu auch die folgenden Kapitel). Die Schlagachse B des TWM darf in einem solchen System nicht als flügelste Achse ausgebildet sein: eine feste Achse B würde bei der Bewegung des (ganzen) Flügels um die Achse A/B ihre Ausrichtung zur tergalen Hebelstelle verändern und wäre nur in einem kurzen Schlagphasenabschnitt günstig ausgerichtet; eine "Schlagachse mit Bewegungsspielraum" weist dagegen diesen Mangel nicht auf. Man kann daher weiter postulieren, daß das Gelenk b kugelgelenkartig ausgebildet war, und daß außerdem der distal von BAS liegende Gelenkspalt nach vorn (zur Costa hin) breiter wurde, um dem Flügel — für seine Bewegung gegenüber dem BAS, um die nicht-flügelste Achse B — einen Spielraum zu geben. Der Vorderrand der Gelenkmembran konnte durch ein auf beiden Seiten mit Gelenken (c und d) verse-

<sup>1</sup>) Dies steht im Gegensatz zu der verbreiteten Auffassung, daß an der Basis der Pterygoten eine überwiegend direkte Schlagmuskulatur verwirklicht war (vgl. z.B. Pringle, 1957, S. 4; Kaestner, 1972, S. 71).



henes Teilstück der Costa, die Humeralplatte HP, eine gewisse Festigkeit behalten und gleichzeitig die für die Funktion des TWM notwendige Relativbewegung des distal von BAS liegenden Flügelteils ermöglichen. Da der Sklerit BAS über die HP an den restlichen Flügel mechanisch angekoppelt blieb, war auch die

Funktion des TPM gewährleistet. Die Gelenke c und d dürften allerdings nicht zu leichtgängig gewesen sein, da sonst bestimmte Muskeln des TPM (v.a. die indirekten Heber) auf der Höhe des vorderen Gelenkkopfes unwirksam geworden wären.

Ein Vorteil des kombinierten Systems "TPM

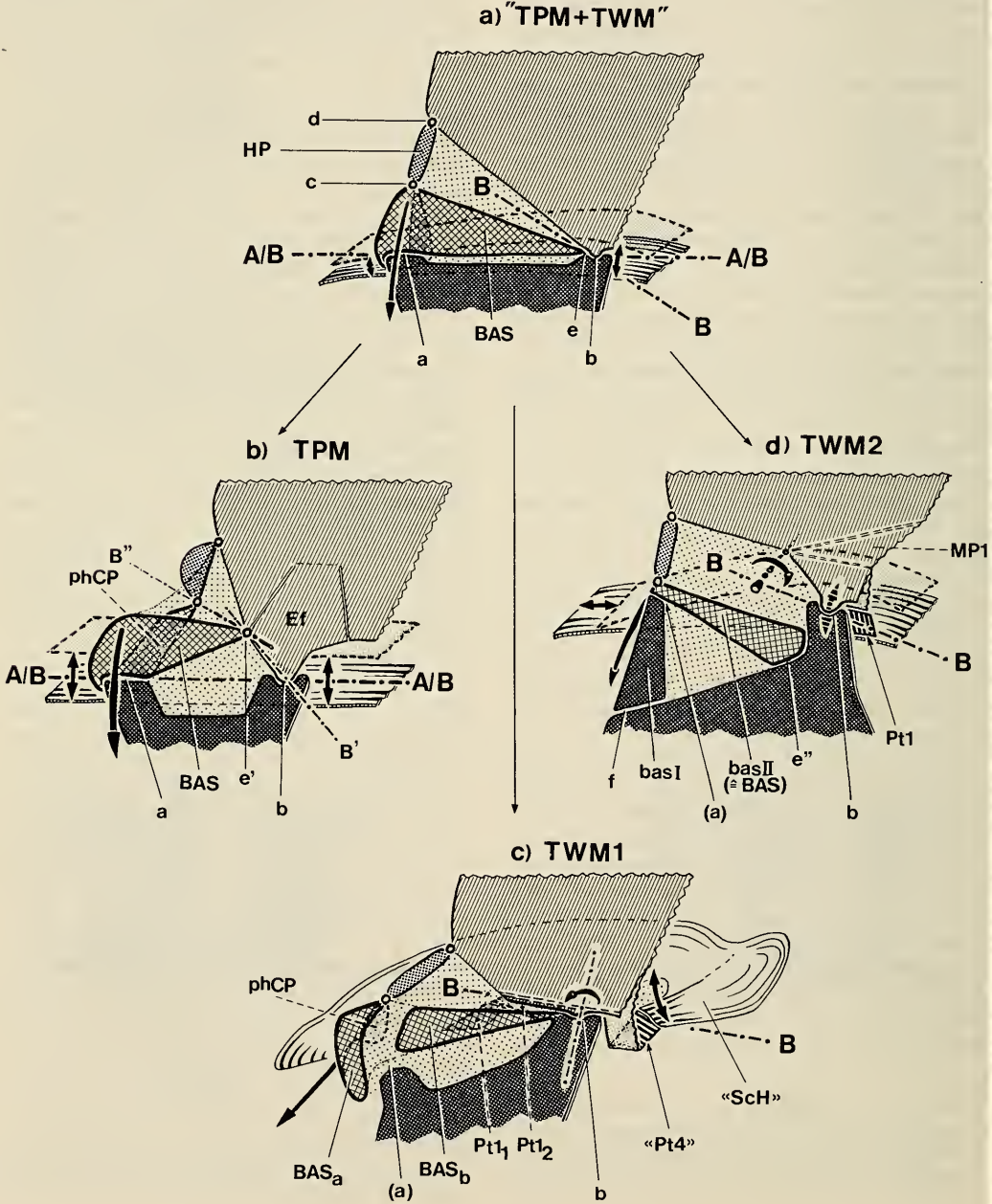

+ TWM" könnte darin bestanden haben, daß die Flügel (je nachdem, ob der TPM- oder der TWM-Anteil stärker eingesetzt wurde) in unterschiedlichen Schlagbahnen bewegt werden konnten. Eine stärkere Beteiligung des TWM würde z.B. (infolge der Bewegung des Flügels um die schräg gestellte Achse B) zu einer flacheren Abschlagsbahn führen. Dabei würde der Flügel gleichzeitig weniger stark proniert; seine Anstellung wäre also der jeweils eingestellten Schlagbahn (bis zu einem gewissen Grad) automatisch angepaßt.

Jede Weiterentwicklung eines ursprünglichen Antriebssystems "TPM + TWM" muß jedoch zwangsläufig dazu führen, daß die beiden beteiligten Mechanismen untereinander in Konflikt geraten; sie konnten daher nicht gleichzeitig verstärkt werden, jedenfalls nicht über einen bestimmten Punkt hinaus. Ein vervollkommener TWM, der das Tergum (durch einen kräftigeren dorsalen Längsmuskel) an der Stelle des hinteren pleuralen Gelenkkopfes weiter nach dorsal wölbt, wäre z.B. auf Kosten des TPM verstärkt: da das Tergum jetzt auf der Höhe des vorderen Gelenkkopfes in der Tierlängsrichtung beweglicher werden muß (s. z.B. den linken Doppelpfeil in Abb. 24d), müßte seine vordere Gelenkverbindung zum Flügel (genauer zum dorsalen Teil des Sklerits BAS) gelöst werden; an dieser Stelle würden die Kräfte der TPM-Muskeln schlechter übertragen, die Hebelwirkung des TPM wäre also dementsprechend verkleinert. Umgekehrt kann eine Weiterentwicklung des TPM nur dann stattfinden, wenn die tergale Kraftübertragung an beiden Gelenkköpfen, also auch am Gelenk a, gesteigert wird; eine Vor-Zurück-Beweglichkeit des Tergum müßte somit an dieser Stelle erschwert werden — der TWM-Anteil würde dementsprechend geschwächt. Aus diesen Gründen tendierte der postulierte Ur-Antrieb "TPM + TWM" wohl schon früh (ab einem

bestimmten Punkt, s. unten) zu einer Trennung seiner Teilmechanismen. Er konnte nie über ein Anfangsstadium hinauskommen. Da es nicht wahrscheinlich ist, daß die Muskeln des TPM und TWM in diesem Ur-System gleichzeitig stärker kontrahiert wurden, vermochten die beiden Teilmechanismen sich auch nur bedingt gegenseitig zu unterstützen — bei größerem Kräfteinsatz konnten sie wohl höchstens wahlweise (einzeln) eingesetzt werden (mit dem oben erwähnten Vorteil?). Höhere Schlaggeschwindigkeiten und -frequenzen waren damit aber sicher noch nicht möglich.

Nach dem oben Dargestellten bedeutete eine (über das beschriebene Ausgangsstadium hinausgehende) Steigerung der Effektivität des Antriebs also zwangsläufig, daß entweder der TWM- oder der TPM-Anteil reduziert (bzw. modifiziert) werden mußte. Wie konnte es aber überhaupt zu einem System "TPM + TWM" kommen, das sich in gewisser Hinsicht in seiner Weiterentwicklung selbst hemmt? Man kann wohl davon ausgehen, daß die Flügel der frühen Pterygoten primär breit (als vergrößerte "Paranota"<sup>1)</sup>) den Thoraxsegmenten ansaßen und zunächst, relativ unbeweglich, als Segelflächen fungierten. Bei der sukzessiven Entwicklung der Schlagbeweglichkeit wurde wahrscheinlich anfangs auf jeden dafür in Frage kommenden Muskel "zurückgegriffen"; so wurden Muskeln einbezogen, die ursprünglich für die Beweglichkeit der Segmente vorhanden waren, und auch solche, die der Erzeugung der Atem- und Beinbewegungen dienten. Das entstandene kombi-

<sup>1)</sup> Der Streit darüber, ob die "Paranota" tergaler, tergo-pleuraler oder gar rein pleuraler Herkunft sind, soll hier nicht berührt werden. Die Argumente, die Matsuda (1981, S. 387, 388) für eine in einigen Gruppen pleurale Herkunft der Flügel anführt, sprechen z.T. eher für einen tergo-pleuralen Ursprung.

Abb. 24. Getrennte Ableitung des Flügelantriebs der Odonata (b) TPM), Ephemeroptera (c) TWM1) und Neoptera (d) TWM2) aus einem "Ur-Flugapparat" "TPM+TWM" (a). Nur der proximale, vordere-mittlere Abschnitt (bis zum Fulcrum-Gelenk) des (aufgeschlagenen) Flügels wurde dargestellt. Pleurum dunkel, Sklerit BAS gekreuzt schraffiert, Membran weit punktiert. Die Sklerit- und Gelenkverbindungen zum Tergum wurden weggelassen (Ausnahmen (c) und (d), wo in der Nähe des Fulcrum liegende Pteralia dargestellt sind — die verdeckten Sklerite der Flügeldorsalseite Pt<sub>1</sub> und Pt<sub>1</sub>, wurden in (c) gestrichelt angedeutet). Tergum stärker schematisiert: für den aufgeschlagenen Flügel ausgezeichnet, für den abgeschlagenen Flügel (außer in (c)) gestrichelt. Der Pfeil am Sklerit BAS deutet die Zugrichtung der "Basalar"-Senker-Muskulatur an, die im Falle von (c) in Wirklichkeit aus zwei weiter getrennten, am BAS<sub>2</sub> angreifenden Muskeln besteht. In (b) wurde die Schrägstellung der Odonaten-Segmente nicht berücksichtigt; die Membran im Gelenkschnitt zwischen BAS und HP ist durchsichtig gedacht, so daß das auf die Dorsalseite gewanderte proximale Gelenk der HP sichtbar wird (vgl. mit a). (c) ist nach den Verhältnissen bei *Ephemer* gezeichnet; der ursprüngliche Zusammenhang der Sklerite BAS<sub>2</sub> und BAS<sub>b</sub> (= BAS) wurde durch punktierte Linien angedeutet. Weiteres s. Text.



nierte System, in dem die für sich schwach entwickelten Teilmechanismen TPM und TWM noch zusammenwirken (sich gegenseitig verstärken bzw. ergänzen) konnten, war für den Antrieb der anfänglich kurzen, mit kleiner Amplitude und niedriger Frequenz schlagenden Flügel wohl ausreichend (auch die Verwindungsfähigkeit der Flügel konnte auf diesem Stadium der Entwicklung geringfügig sein — die Flügel wurden möglicherweise weitgehend passiv proniert und supiniert). Daß es mit dem "TPM + TWM"-System nicht weiterging, stellte sich erst später, bei Erreichen seiner Grenzen, heraus.

In den folgenden Kapiteln wird der Versuch unternommen, die Grundplankonstruktionen und -funktionen der rezenten Gruppen (\*Odonata, \*Ephemeroptera, \*Neoptera) darzustellen und von der postulierten Ausgangskonstruktion "TPM + TWM" abzuleiten. Dabei soll jeweils auch die Frage verfolgt werden, ob eine "TPM + TWM"-Urform — mit zwei Antriebsmechanismen und zwei Schlagachsen — für die Ableitung der betreffenden Gruppe überhaupt notwendig ist, oder ob nicht eher von einer Konstruktion ausgegangen werden kann, die einem rezenten Flugapparat-Typ ähnlich war.

#### Die Ableitung der Odonata

Vergleicht man die in der Abb. 24a dargestellte hypothetische Ausgangskonstruktion der Pterygoten mit dem Flugapparat der Odonaten (Abb. 24b), so zeigt sich ein wesentlicher Unterschied: der Flügelteil BAS artikuliert bei Odonaten kaudal an der Stelle  $e'$  (entspricht  $c4$ ), also innerhalb des Flügels; die Achse B ist dadurch (durch 2 Gelenkpunkte,  $b$  und  $e'$ ) festgelegt ( $\rightarrow B'$ ). Diese Situation kann durch eine Verlagerung der Gelenkstelle  $e$  nach  $e'$  leicht erreicht werden — eine nur geringfügig erscheinende Veränderung des "TPM + TWM"-Systems also, die jedoch eine Verstärkung des TPM und Schwächung des TWM mit sich bringt (der TWM wurde im Zuge der Entwicklung zu einem Stellmechanismus dann weiter umkonstruiert; s. unten).

Die daraus folgende Effektivierung des TPM-Anteils ist leicht einzusehen: Durch die Verlagerung des kaudalen BAS-Gelenks in den Flügel wird der distal von der Achse  $B'$  liegende Flügelhauptteil enger an den Skleriten BAS angeköpelt, und die Wirkung der direkten Senker und indirekten Heber so gleichmäßiger auf die ganze Flügelbreite zwischen den beiden Fulcren verteilt. Bei den rezenten Libellen existieren

dementsprechend vordere und hintere direkte Senker, die Basalar- und Subalarmuskeln, die (in Teilfunktionen zwar etwas unterschiedlich) ihren Abschlags-Kraftanteil jeweils auf beide Basissklerite des Flügels verteilen; der einzige indirekte Heber, der  $dvm1$ , wirkt über ein breiteres tergales Gelenkgebiet ebenfalls auf beide Teile (möglicherweise sind in der Vorgeschichte der Odonaten mehrere  $dvm$ -Muskeln sekundär zusammengedrückt). Radioanalplatte und Costalplatte (letztere entspricht BAS + HP) der rezenten Odonaten sind damit beim Flügelschlag als funktionelle Einheit zu betrachten (vgl. auch S. 50).

Der Anteil des TWM am Flügelantrieb wird automatisch in dem Moment verringert, in dem der kaudale BAS-Gelenkpunkt  $e$  vom Gelenk  $b$  weg in den Flügel verlegt wird. Einerseits hängt dies damit zusammen, daß die Funktion des TWM eine nicht-flügelsteife Schlagachse B benötigt (vgl. S. 79f.), andererseits wird der  $d1m$  (mit der Festlegung der Achse) gleichzeitig zu einem Hilfsmuskel des TPM, da er nun (neben der Bewegung des Flügels um  $B'$ ) auch den ganzen Flügel (incl. BAS!) um die TPM-Achse A/B bewegt. Da die tergaale Mechanik aber im weiteren Verlauf der Evolution stärker modifiziert wurde (sie wurde v.a. einer Achse  $B'' = C2/C4$  "angepaßt" — die Schubrichtung der  $d1m$  konnte durch Verlagerung von  $t2$  in die Tiefe leicht verändert werden; vgl. auch S. 57ff. und weiter unten), und dabei bestimmte mechanische Voraussetzungen für die  $d1m$  geschaffen wurden, die deren Wirksamkeit auf einen kurzen Abschnitt des Flügelschlags (das Ende der Abschlagsphase) einschränken, sind TPM-Antrieb und TWM-Stellmechanismus bei den rezenten Odonaten funktionell (weitgehend<sup>1)</sup>) getrennt.

Die komplizierte tergaale Mechanik und die Funktionsbeschränkung des dorsalen Längsmuskels auf einen kurzen Phasenabschnitt "zwischen den beiden Schlagphasen" deuten — bei Vergleich mit den übrigen Pterygoten — darauf hin, daß der Vor-Zurückschwingmechanismus der Odonaten stark abgeleitet ist. So kann aus der entgegengesetzten Funktion der dorsalen Längsmuskeln im Meso- und Metathorax bei Zygopteren und Anisozygopteren (vgl. S. 61) auf eine primär in beiden Segmenten gleichartige Funktion geschlossen werden. Entgegengesetzt die Flügel bewegende serial-ho-

<sup>1)</sup> Möglicherweise behielt der  $d1m$  bei rezenten Libellen noch eine geringfügige Abschlags-Teilfunktion (bezüglich der Achse  $P1/P2 = A/B'$ ) bei.



mologe dlm erscheinen ja nur denkbar, wenn die Funktionen zunächst zusätzlich zu einer älteren, in beiden Segmenten gleichartigen Funktion, nämlich der Abschlagsfunktion, evoluiert wurden; mit der Reduktion der Abschlagsfunktion konnten sich die Nebenfunktionen dann zu Hauptfunktionen der dlm entwickeln. Der Vor-Zurückschwingmechanismus kann dabei relativ leicht aus dem ursprünglichen Antriebs-Teilmechanismus TWM des "Ur-Flugapparates" abgeleitet werden. Es bedarf nur der Versetzung von zwei Gelenkstellen des BAS, um aus der primären Drehachse B des TWM die Achsen B' und B" (Abb. 24b) zu entwickeln: e muß in den Flügel wandern ( $\rightarrow e'$ ), und das distale Gelenk c (zur Humeralplatte) muß auf die Flügel-Dorsalseite verlegt werden ( $\rightarrow c2$ ). Durch die Verlagerung von c wird zusätzlich zur Achse B' (P2/C4) eine zweite, in einem stumpfen Winkel zu ihr stehende Scharnierachse B" (C2/C4) gebildet. Während B' (ebenso wie die Achse C1) ungefähr in der Flügelebene liegt und (zusammen mit C1) die Drehbewegungen des Flügels um die Längsachse im Abschlagsdrehbereich bestimmt, wurde die schräg auf der Flügelfläche stehende Achse B" zur Drehachse des modifizierten TWM-Systems (Vor-Zurückschwing-System). Der dlm war möglicherweise in einer Übergangsphase — bei einem weniger weit "versenkten" Gelenk t2 — auch über die Achse B' (als Supinator) wirksam. Obwohl wir über die auf der Basis der Odonaten abgelaufenen evolutiven Vorgänge wahrscheinlich nie befriedigende Aufschlüsse bekommen können, erscheint also prinzipiell folgender Ablauf denkbar: 1) Der dlm wirkt über B (ursprüngliches TWM-System; Abb. 24a); 2) die Achse B wird zu B' (der dlm wirkt damit über B' und A/B); 3) B' "spaltet" B" ab (der dlm wirkt über B', B" und A/B); 4) t2 wird tiefer gelegt — der dlm wirkt nun (ausschließlich?) über B" (stark modifiziertes TWM-System; Abb. 24b).

Im Zusammenhang mit der hier im Groben behandelten Evolution des Odonaten-Flugmechanismus (Verstärkung des TPM und Spezialisierung des TWM) stehen zahlreiche (v.a. tergale) Veränderungen des Skeletts. So wurde das Tergum im Mesothorax auf der Höhe des vorderen Gelenkkopfes (a) um eine Querachse beweglich (vgl. S. 58); Tergum und Flügel bleiben damit an dieser Stelle in engem Kontakt, so daß eine Verschiebung des (vorderen) Tergum in der Tierlängsrichtung, welche den TPM schwächen würde, vermieden wird. Durch verschiedene Gelenke im tergalen Seitenbereich

(zwischen vTS, hTS und anschließenden Teilen) — die z.T. wohl schon ursprünglich vorhanden waren (vgl. S. 87f.) — wird die Hebelwirkung der dorsalen Längsmuskeln auf das hintere Fulcrum (b) konzentriert; die bei der Kaudalverschiebung des (mittleren) Tergum stattfindende Schrägstellung der dvm wird zu Beginn des Aufschlags (automatisch) wieder rückgängig gemacht, so daß der TPM auch hier höchstens kurzfristig beeinträchtigt wird (vgl. S. 60).

Offensichtlich stehen Antriebssystem und Stellmechanismen bei Odonaten in einem komplexen funktionellen Zusammenhang, der im Verlauf der Evolution nur einen schmalen, "gangbaren" Weg zuließ. Dies kann der folgende Gedankengang aufzeigen: Setzt man ein Ausgangssystem "TPM + TWM" voraus, so kann angenommen werden, daß die Stelle des Tergalzapfens (TZ) ursprünglich im TWM-System (in dem der dlm noch als Senker fungierte) an der Abschlags-Hebelbewegung beteiligt war, und daß das Gelenk t2 noch als längeres (sich in Tierlängsrichtung erstreckendes) Gelenkgebiet zwischen Tergum und Flügel (bzw. Pteralia) ausgebildet war (vgl. auch S. 105). Das Gelenk t2 ist bei rezenten Odonaten jedoch ein punktförmiges Gelenk und ermöglicht erst dadurch die Drehbewegungen im Abschlagsdrehbereich. Würde das BAS-Gelenk e sich in dieser Situation noch an der Stelle b befinden, so würden die Basalarmuskeln pronatorisch wirken (was übrigens primär, bei einem langgestreckten Gelenk t2, nicht der Fall war); da die Gelenkstelle e jedoch, zur Steigerung der Effizienz des TPM, in den Flügel verlegt wurde ( $\rightarrow e'$ ), wurde diese Funktionsänderung vermieden (s. auch S. 50). Daraus ergibt sich, daß der Drehmechanismus des Flügels im Abschlagsdrehbereich — ebenso wie der Mechanismus des Flügelvor- und -zurückschwingens — erst mit der Weiterentwicklung des TPM überhaupt entstehen konnte. Die vorderen Abschlags-Antriebsmuskeln des TPM (bas) machten dabei keinen Funktionswechsel durch (vgl. dazu auch S. 91).

Bei den Odonaten führten die Veränderungen im Bereich von t2, der ursprünglich wohl ausgedehnteren tergalen Hebelstelle des TWM, anscheinend auch zu stärkeren Abwandlungen der Hebelbewegung primär übertragenden Gelenksklerite (Pteralia 1 und evtl. auch Pterale 4). Die genaue Lage des Pterale 1, das bei Neopteren und Ephemeropteren auf der Höhe des hinteren Fulcrum (bzw. kurz davor) liegt — und

sogar sein Vorhandensein bei Libellen überhaupt — ist jedoch umstritten. Keineswegs dürfte z.B. der vordere Tergalsklerit vTS (Abb. 1a) dem Pterale 1 entsprechen (wie etwa Tannert, 1958, annahm), da er sich im Gebiet des vorderen Gelenkkopfes (und der CP) befindet und aufgrund seines Muskels tp mit einem anderen Sklerit, der Subtegula, homologisiert werden kann (vgl. S. 88). Ich vermute stattdessen, daß der vorn an die RAP angrenzende 1. Gelenksklerit G1<sup>1)</sup> dem Pterale 1 homolog ist. Darauf deutet der an diesem Teil inserierende Muskel hca hin, da ein ganz entsprechender Muskel, der ebenfalls in Beziehung zu einem "Pterale 1" steht, bei Neopteren und Ephemeropteren existiert (vgl. S. 86f.)! Auch die Beziehung des Sklerits G1 zur Subcosta (über die Ader cr<sub>1</sub>; vgl. Abb. 1a) spricht dafür (s. dagegen Matsuda, 1979, l.c. S. 6). Trifft diese Homologisierung zu, so hätte das Pterale 1 bei Odonaten seine ursprüngliche Funktion als Übertragungselement der Muskelkräfte des TWM vollständig verloren. Ein dem Pterale 2 homologer Kutikula-Bereich läge dann innerhalb der RAP, kann jedoch schon deshalb nicht genauer abgegrenzt werden, weil das Pterale 2 erst im Zusammenhang mit der Entwicklung der Neopterie (Entstehung der Mittelplatten-Gelenke) überhaupt in Erscheinung tritt (vgl. S. 90f.)<sup>1)</sup>. Erschwerend für das Erkennen eines homologen Skleritbereiches ist, daß die RAP bei Libellen, dort, wo sie dem Fulcrum aufliegt, nicht durchgängig sklerotisiert ist; d.h., Dorsal- und Ventralwand der Flügelbasis sind an der Stelle des Pterale 2 (im Gegensatz zu den Neopteren) voneinander getrennt. Möglicherweise ist dies als eine Folge des abgeleiteten Flügel-Verwindungsmechanismus (vgl. S. 47ff.) anzusehen.

Erst die Umwandlung des "TPM + TWM"-Antriebssystems in ein weitgehend reines TPM-System ergab (neben der allgemeinen Verstärkung des Flügelantriebs) eine für die Odonatenevolution sicher sehr wesentliche Möglichkeit: der mesothorakale Antrieb konnte vom metathorakalen entkoppelt werden, so daß Vorder- und Hinterflügel verschieden stark oder auch mit einer größeren Phasendifferenz geschlagen werden konnten. In einem TWM-System existiert dieser, für die Manövrierfähigkeit wesentliche, Vorteil dagegen nicht: Mit vier Flügeln gut fliegende Neopteren (z.B. *Locusta*)

zeigen, daß ein in beiden Segmenten stärker entwickelter TWM-Flügelantrieb nur dann möglich ist, wenn das mittlere Phragma das relativ festliegende Ursprungsgebiet beider dlm-Paare bildet; Vorder- und Hinterflügel müssen in diesem Fall weitgehend synchron bewegt werden, da der Schlagmechanismus der beiden Flügel-paare tergal gekoppelt ist<sup>2)</sup>. Eine darüber hinausgehende Leistungssteigerung des TWM (wie etwa bei Dipteren, Hymenopteren, Strepsipteren oder Ephemeropteren) konnte anscheinend stets nur für ein Flügelsegment erreicht werden, was aber auf Kosten des anderen gehen mußte. Der "Verzicht" der Odonaten auf die (bei Effektivierung des TWM in beiden Segmenten notwendigerweise "segmentkoppelnden") dorsalen Längsmuskeln als Antriebsmuskeln kann somit als die wesentliche Voraussetzung für die (fast vollständige) Unabhängigkeit der Vorder- und Hinterflügel angesehen werden. (Erst dadurch wurde andererseits eine in beiden Segmenten unterschiedliche Funktionsdifferenzierung der dlm möglich.) Der Flügelantrieb konnte (einmalig bei Pterygoten!) in beiden Segmenten gleichermaßen verstärkt werden.

Von der Odonatenkonstruktion ausgehend können die Flugapparate der Ephemeropteren (Abb. 24c) und Neopteren (Abb. 24d) — selbst wenn man nur das Antriebssystem berücksichtigt — nur schwer abgeleitet werden. Zur Herausbildung eines TWM-Systems aus dem TPM müßte z.B. der Gelenkpunkt e' des BAS zunächst (unter Schwächung des TPM) zum Fulcrum hin wandern. Eine voll funktionsfähige TWM-Schlagachse B käme aber erst dann zum Einsatz, wenn der Sklerit BAS kaudal direkt bei b artikuliert (dies entspräche der Konstellation

<sup>2)</sup> Die auch räumlich in engeren Kontakt kommenden Flügel sind bei den Feldheuschrecken allerdings unterschiedlich spezialisiert — die Vorderflügel sind z.B. weitaus weniger an der Auftriebserzeugung beteiligt als die Hinterflügel (vgl. Weis-Fogh, 1956, l.c. S. 567). Eine andere Möglichkeit, beide dlm-Paare effektiv einzusetzen, wäre eine gegenphasische Kontraktion, doch sind mir keine Insekten bekannt, die auf dieser Basis eine besser entwickelte Flugfähigkeit erreicht haben. Bei weniger gut fliegenden Pterygoten (etwa den Plecopteren, Mecopteren und den meisten Gruppen der Neuropteroidea) ist die Kopplung der beiden Thoraxsegmente übrigens noch relativ schwach: die beiden dlm-Paare beeinflussen sich am mittleren Phragma, das einen breiteren "Gelenk" einschneidet zwischen den Terga darstellt, nur geringfügig.

<sup>1)</sup> Eine Homologisierung des Sklerits G1 mit dem Pterale 2 (Hamilton, 1971) erscheint mir nicht begründbar.



bei Eintagsfliegen). Jetzt könnte (auf dem Weg zu den Neoptera) das Odonaten-Schlagscharnier *a/b* (und damit die Schlagachse *A/B*) reduziert werden; daran anschließend könnte der kaudale Artikulationspunkt des Sklerits *BAS* weiter nach ventral in das Pleurum ( $\rightarrow e$ ) wandern (eine funktionsfähige Schlagachse *A/B* kann ja vorher nicht einfach "überschritten" werden). Schon für den (zunächst sicher nicht vorteilhaften) "Rückzug" aus dem einen Mechanismus, zur Erreichung des Ausgangspunktes für den anderen, fehlt ein positiver Selektionsdruck. Berücksichtigt man die hochspezialisierten Stellmechanismen der Odonaten, so erscheint diese Leserichtung noch schwerer vorstellbar.

Eine weitere (umgekehrte) Denkmöglichkeit wäre die, daß der Sklerit *BAS*, ausgehend von einem neopteroiden Zustand (Abb. 24d), erst bei den Vorfahren der Odonaten in den Flügel eingewandert ist. Sie ist aber ebenfalls wenig wahrscheinlich. Eine Drehachse *A/B* darf z.B. bei dieser Entwicklung nicht zu früh gebildet werden, da sie vom Sklerit *BAS* sonst nicht mehr "überschritten" werden kann. Ein funktionsfähiges Scharniergelenk *a/b* könnte also erst dann entstehen, wenn die kaudale Gelenkstelle *e* des *BAS* bereits am Gelenkpunkt *b* angelangt ist ( $\rightarrow e$ ). Daraufhin könnte das Gelenk *e* vom Pleurum weg in den Flügel wandern; der *TWM* würde dabei geschwächt, der neugebildete *TPM* effektiviert. Auch diese Ableitung erfordert also, wenn keine Funktionslücke entstehen soll, ein Übergangsstadium mit zwei Schlagachsen <sup>1)</sup>; sie ist jedoch umständlicher als der direkt bei "*TPM* + *TWM*" beginnende Weg. Ausgehend von einem einachsigen System (*TWM*, Achse *B*) existiert außerdem kein ersichtlicher Selektionsvorteil, der eine Verlagerung des Sklerits *BAS* ("zum Zwecke einer späteren Bildung" der Schlagachse *A/B*) begründen könnte.

#### Die Ableitung der Ephemeroptera <sup>2)</sup>

Der Schlagmechanismus der Ephemeropteren (Abb. 24c) läßt sich ebenfalls leicht vom Ur-Mechanismus "*TPM* + *TWM*" (S. 78ff.) ableiten

<sup>1)</sup> Als unwahrscheinlich kann angesehen werden, daß die Schlagachse *B* durch Veränderung ihrer Ausrichtung direkt in die Achse *A/B* übergegangen ist. Außerdem existieren bei rezenten Odonaten anscheinend noch "Abkömmlinge" der Achse *B* (*B'*, *B''*).

<sup>2)</sup> Eine ausführliche Darstellung der Flügelmechanik der Ephemeropteren ist in Vorbereitung.

— in diesem Fall durch Weiterentwicklung des *TWM* und Reduktion des *TPM*. Die *TWM*-Effektivität konnte z.B. durch membranöse Randeinschnitte auf beiden Seiten des Tergum (Tergalspalte), wenig kaudal vom Fulcrumgelenk *b*, gesteigert werden. Da bei den Ephemeropteren aber v.a. der mesothorakale Antrieb weiterentwickelt wurde — und zwar dadurch, daß der hinter dem Tergaleinschnitt liegende Teil des Tergum ("*ScH*", Scutellarhebel) stärker beweglich wurde als der davor liegende —, war dies (zwangsläufig, vgl. S. 84) gleichzeitig mit einer weitgehenden Reduktion des metathorakalen Systems verbunden. In dieser Hinsicht besteht eine Analogie zu verschiedenen neopteren Gruppen (vgl. S. 88): Der Hebelsklerit, der die Bewegung des Tergum auf den Flügel überträgt, liegt bei den Ephemeropteren nämlich nicht bei *b*, auf der Höhe des Fulcrum, sondern kaudal davon (der tergale Hebelpunkt ist also vom pleuralen Drehpunkt weiter entfernt). Er artikuliert mit dem Flügel in dem Bereich, in dem bei den Neopteren das Pterale 3 liegt; ein Pterale 3 ist zwar bei den Ephemeropteren nicht eindeutig abgrenzbar, sein Gebiet ist jedoch durch einen zum Fulcrum ziehenden Muskel — den Pterale-3-Muskel der Neopteren, der wohl dem *fa* der Odonaten homolog ist <sup>3)</sup> — gekennzeichnet. Somit ist der Hebelsklerit der Ephemeroptera möglicherweise dem Pterale 4 der Neopteren homolog (und nicht dem Pterale 1) — er soll im weiteren als "*Pt 4*" bezeichnet werden.

Bei den Eintagsfliegen führen Bewegungen des Scutellarhebels "*ScH*" nach oben-vorn-außen und zurück zu einem Ab- bzw. Aufschlag des Flügels um eine Schlagachse *B*. Die Achse *B* wird in diesem Fall v.a. durch ein Scharniergelenk bestimmt, das vor dem "*ScH*" und "*Pt4*" und lateral von einem Gelenksklerit *Pt*<sub>2</sub> in der dorsalen Kutikula der Flügelbasis liegt (Abb. 24c). Die proximale Kante des Sklerits *Pt*<sub>2</sub> bildet vorn ein Gelenk zu einem weiteren kleinen Sklerit *Pt*<sub>1</sub>; das *Pt*<sub>1</sub> artikuliert seinerseits, mit seiner medialen Kante, am Tergalrand (der in der Abb. 24c nicht eingezeichnet ist).

Entsprechend der Bewegung des Scutellarhebels (mit einer Komponente "nach vorn"; s. Doppelpfeil in Abb. 24c) und der Ausrichtung der Schlagachse *B* verläuft die Grundschlagbahn des Flügels steil. Sie ist jedoch nicht unveränderlich. Der Flügel kann nämlich — mitsamt

<sup>3)</sup> *Pm*<sub>14</sub> bei Brodskyi, 1970.



der Schlagscharnierachse B — durch die am vorderen Teil des Skleriten BAS angreifenden Senkermuskeln (Zugrichtung s. Pfeil links in der Abb. 24c) im Fulcrum-Gelenk b um eine durch b verlaufende Hochachse (s. die senkrecht zu B stehende Punkt-Strichlinie) nach vorn gedreht werden. Je stärker diese Muskeln (in Relation zu den dorsalen Längsmuskeln — und zu den Subalarmuskeln, s. unten) kontrahiert werden, um so mehr wird die Achse B während des Abschlags um die Hochachse gedreht, um so horizontaler liegt die resultierende Schwingungsebene des Flügels. Dabei werden die Sklerite Pt<sub>1,2</sub>, je nach Schlagbahn, mehr oder weniger gefaltet, wobei das Pt<sub>2</sub> sich mediad über das Pt<sub>1</sub> bewegt. Ausgespannt begrenzen die Sklerite den Schlagbahn-Spielraum zur Vertikalen hin.

Das ephemeropteroide Antriebssystem kann durch eine Veränderung der Ausrichtung der Schlagachse B (die zu einer vertikaler gestellten Grundschißbahn führte) sowie durch Änderungen der tergalen Mechanik (→ "Sch") leicht von einem "TMP + TWM"-Ausgangszustand abgeleitet werden. Auch hier mußten die Stellsysteme wahrscheinlich Hand in Hand mit dem Antriebssystem entwickelt werden: Eine steiler gestellte Grundschißbahnebene ist z.B. erst dann sinnvoll, wenn der Schlagbahn-Spielraum gleichzeitig zur Horizontalen hin erweitert wird. Um dies zu erreichen, war es notwendig, den Flügelteil BAS durch eine Membranisierung auf der Höhe des Schlaggelenks a in zwei Elemente zu zerteilen. Vorderer Gelenkkopf und Sklerit BAS (bzw. seine beiden entstandenen Teile BAS<sub>a</sub> und BAS<sub>b</sub>) wurden auf diese Weise funktionell getrennt; jetzt konnte der (funktionslos gewordene) vordere Gelenkkopf weiter nach unten abgesenkt werden. Erst mit der Entwicklung des Membranspielraums zwischen BAS<sub>a</sub> und BAS<sub>b</sub> und der Reduktion des vorderen Schlaggelenks wurde es überhaupt möglich, die Zugrichtung der vorderen Senker (Basalarmuskeln) stärker zu verändern, d.h. durch eine einfache Verlagerung ihres sternalen Ursprungs schräger zu stellen, so daß sie den Flügel in der oben beschriebenen Weise (mitsamt der Schlagachse B) nach vorn bewegen konnten. Die Basalarmuskeln schlagen den Flügel außerdem wohl weiterhin um die Achse B abwärts. Der Subalarmuskel (nicht abgebildet) ist anscheinend Antagonist der Basalarmuskeln — zumindest ein Teil des mächtigen Muskels (dessen Faserverlauf sehr kompliziert ist) wirkt flügelrückziehend; bezüglich des Flü-

gelschlags bleibt er ein synergistischer Senker.

Bemerkenswert ist, daß der Flügelteil BAS bei den Ephemeropteren im hinteren Bereich überhaupt erhalten blieb (als BAS<sub>b</sub>) und kaudal, wie im ursprünglichen "TPM + TWM"-System, zwischen dem Flügel und dem Pleurum schmal endet, ohne dort allerdings ein eigentliches Gelenk zu bilden. Anscheinend stellt der Sklerit BAS<sub>b</sub> ein federndes Element dar, das bei horizontaler geführten Flügelabschlägen senkrecht zur Pleuralebene nach medial abgebogen wird.

Da der tergale Hebel "Sch" beim Ephemeropterenflügel weit kaudal (am "Pt<sub>4</sub>") angreift, wurden die davor liegenden Sklerite Pt<sub>1</sub> und Pt<sub>2</sub> für die mechanische Führung der Schlagbahn-Stellbewegung frei. Sie ermöglichen eine Art Faltung des Flügels (s. oben), die den Flügel — im Gegensatz zur Faltbewegung bei Neopteren (s. S. 90) — nach vorn führt. Die Schlagbahn-Stellbewegung der Ephemeropteren betrifft außerdem, da die Pteralia 1 ganz proximal liegen, praktisch den ganzen Flügel; bei den Neopteren entstanden die Mittelplatten-Faltgelenke dagegen weiter distal, innerhalb des Flügels, so daß die proximalen, die Antriebskräfte übertragenden Sklerite Pterale 1 und Pterale 2 bei einer Schlagbahnänderung nicht mitbewegt werden (vgl. Abb. 24d).

In der Literatur werden die beiden vorderen Pteralia (Pt<sub>1,2</sub>) der Ephemeropteren oft mit dem Pterale 1 und 2 der Neopteren homologisiert (s. z.B. Matsuda, 1970; Hamilton, 1971). Da das Pterale 2 jedoch bei Neopteren dem Fulcrum aufliegt und durch ein laterales Gelenk abgegrenzt ist, das (bezogen auf die Schlagachse B) weiter distal im Flügel liegt als das laterale Gelenk des Pt<sub>2</sub> der Ephemeropteren (durch welches die Achse B verläuft), ist diese Homologisierung wohl nicht zutreffend. Das Pterale 2 entstand — als abgrenzbarer Sklerit — erst in der Stammgruppe der Neoptera, im Zusammenhang mit der Ausbildung der Mittelplattengelenke und der Neopterie (s. S. 90f.). Das laterale Gelenk des Pterale 1<sub>2</sub> der Ephemeroptera ist daher eher dem lateralen Gelenk des Neopteren-Pterale 1 gleichzusetzen, so daß die beiden Pteralia Pt<sub>1</sub> und Pt<sub>2</sub> also gemeinsam mit dem Pterale 1 der Neoptera homologisiert werden können. Für die Homologisierung (zumindest des hinteren Sklerits Pt<sub>2</sub>) mit dem Pterale 1 der Neoptera spricht übrigens auch ein Muskel (der Pm<sub>10</sub> bei Brodskyi, 1970; t-33 bei Matsuda, 1970), der von einem proximalen Fortsatz des Gelenkstücks nach ventral zu einer

Furca-ähnlichen Bildung des Sternalbereichs zieht (Furca bei Matsuda, 1970, l.c. Fig. 43B; Fu bei Brodskyi, 1970, Fig. 4). Da diese "Furca" der Ephemeropteren mit den, nach ventral verlagerten, Pleuralarmen der Neoptera homologisiert werden kann (dafür spricht ein quer-verlaufender, unpaarer Muskel, der sich — bei Reduktion der eigentlichen Furca — als Verschmelzungsprodukt der paarigen Furca-Pleuralarm-Muskeln deuten läßt), stimmt der  $Pt_2$ -Muskel bezüglich Ansatz und Ursprung mit dem Pterale-1-Muskel der Neoptera überein<sup>1)</sup>. (Zur möglichen Homologisierung des  $Pt_1$ -Muskels mit dem  $hca$  der Odonaten vgl. S. 83f.)

Der Flügelschlagmechanismus der Ephemeroptera (TWM1 mit Schlagbahnspielraum "nach vorn"; Abb. 24c) erscheint in seinen Entwicklungsmöglichkeiten — verglichen mit dem (TWM 2-) Mechanismus der Neoptera — insofern "benachteiligt" zu sein, als sich Schlagantriebs- und Schlagbahnstell-Bewegung zwangsläufig kaudal am "Pt4" wechselseitig beeinflussen. Diese Ausbildung des TWM ist jedoch als so hoch spezialisiert anzusehen, daß sie (einmal entwickelt) als Ausgangspunkt für die Evolution der anderen rezenten Systeme nicht mehr in Frage kommt. Der gegenüber den Neopteren (vgl. S. 88) grundverschiedene Flügelantrieb über das kaudale "Pt4" spricht andererseits auch gegen eine Ableitung des Ephemeropteren-Mechanismus aus einem Neopteren-ähnlichen Vorstadium. Bei einem Vergleich der Abbildungen 24c und d könnte man dennoch zu der Ansicht kommen, daß im Bereich des "Basalarsystems" homologe, synapomorphe Gemeinsamkeiten der beiden Gruppen Neoptera und Ephemeroptera existieren. So könnte die Stelle des (reduzierten) vorderen pleuralen Schlaggelenks der Ephemeropteren ((a)) z.B. mit dem Gelenk f der Neopteren gleichgesetzt werden. Dann wäre der Sklerit  $BAS_a$  mit dem bas I der Neopteren zu homologisieren, der  $BAS_b$  mit dem bas II. Dagegen spricht jedoch Verschiedenes: Wie bei den Neopteren existiert auch bei Ephemeropteren — kaudal vom mesothorakalen Stigma — ein Skleritbezirk zwischen Präscutum und Pleurum, der sog. Tergalarm

(nicht eingezeichnet in der Abb 24; vgl. etwa Weber, 1933; prealare bei Snodgrass, 1935). Diese Struktur steht bei Eintagsfliegen weder mit dem Tergum noch mit dem Pleurum in direktem Kontakt und ist nur schwach sklerotisiert (aus funktionellen Gründen: die Basalarmuskeln benötigen Bewegungsspielraum nach vorn!); ventral endet sie unterhalb vom "Rest" des vorderen Gelenkkopfes. Bei den Neoptera liegt die ventrale Kontaktstelle des Tergalarms dagegen dorsal des (neugebildeten) Gelenks f (und spricht so ebenfalls für die auf S. 88f. dargelegte pleurale Herkunft des bas I)<sup>2)</sup>. Die Stellen f und a und die Sklerite bas I und  $BAS_a$  wären demnach — wenn man von einer Homologie und stabilen Lagebeziehung der Tergalarme in den beiden Gruppen ausgeht — nicht homolog. Außerdem existiert bei den Ephemeropteren im Bereich des vorderen Gelenkkopfes noch ein pleuro-tergaler Muskel ( $t-p_{10}$  bei Matsuda, 1970;  $Pm_{11}$  bei Brodskyi, 1970), während die Muskulatur dieses Gebiets bei den Neopteren — im Zusammenhang mit der Bildung des Gelenks f und des Sklerits bas I — anscheinend in das Bewegungssystem der beiden Basalaria übernommen worden ist (vgl. S. 88ff.).

Erwähnenswert sind noch einige weitgehende Übereinstimmungen — v.a. im dorsalen Bereich des Sklerits  $BAS$  — zwischen Ephemeropteren und Odonaten, die durchaus synapomorph sein könnten (und damit eine nähere Verwandtschaft der beiden Gruppen begründen würden), jedoch hier vorerst als symplesiomorph gewertet werden (d.h.: es wird zunächst angenommen, daß diese Merkmale — in einem noch nicht genauer zu rekonstruierenden Vorzustand — schon bei dem hypothetischen Ur-Flugapparat der Pterygota vorhanden waren). So erstreckt sich vom proximalen Humeralplatten-Gelenk c bei Eintagsfliegen (deutlich etwa bei *Ephemer*) ein abgrenzbarer kaudaler Teil des  $BAS$  in Richtung Tergalrand, der mit großer Wahrscheinlichkeit dem Abschnitt  $phCP$  der Odonaten-Costalplatte homolog ist (in den Abb. 24a, b, c wurde sein Umriß gestrichelt angedeutet). Proximal davon liegt ein Sklerit, der mit dem (bei Odonaten verschmälerten) Randsklerit  $RS$  ho-

<sup>2)</sup> Es ist anzunehmen, daß der Tergalarm bei Pterygoten ursprünglich vorhanden war. Bei Odonaten ist er möglicherweise zu einer Tegula-ähnlichen Struktur umgebildet (s. z.B. die Abb. 4b auf S. 442 bei Tannert, 1958; nicht näher bezeichnete Struktur vor der Hinterflügel-CP; und die Übersichtsabbildung, l.c. S. 439: Struktur frontal-medial von der Vorderflügel-CP).

<sup>1)</sup> Bei beiden Gruppen inseriert der Muskel auf der Höhe des Tergalspaltes am Pterale 1<sub>(2)</sub> (bei Ephemeropteren dicht beim Vorderrand des Membran-einschnittes). Da die Tergalspalte anscheinend nicht homolog sind (vgl. S. 88), ist diese Übereinstimmung als Analogie zu interpretieren.



mologisiert werden kann, da an seinem Kaudalrand in beiden Gruppen ein homologisierbarer Muskel inseriert (der *vca*; *t-cx4* bei Matsuda, 1970; *Pm<sub>3</sub>* bei Brodskyi, 1970)<sup>1)</sup>. Dieser Sklerit steht bei Ephemeropteren seinerseits über ein proximales Punktgelenk mit dem Tergalrand in Kontakt, und zwar kaudal von einem kleinen Sklerit (dem *vTS* der Odonaten bzw. der Subtegula der Neopteren), der sich in allen drei rezenten Gruppen aufgrund seines Muskels (*tp*, Abb. 2) identifizieren läßt. Durch diese "Aufhängung" wird der Sklerit *BAS<sub>a</sub>* der Eintagsfliegen (der veränderten Zugrichtung der Basalarmuskeln entsprechend) auch gegenüber dem Tergum nach vorn beweglich und erhält zugleich eine Führung und Limitierung. Bei den Neopteren verlief die Entwicklung in diesem Bereich ganz anders, da der Sklerit *BAS* sich in dieser Gruppe (ebenfalls im Zusammenhang mit einem Funktionswechsel seiner Muskeln) durch Reduktion seiner dorsalen Anteile vollständig vom Tergum gelöst hat; in diesem Fall wurde eine pleurale Aufhängung neu gebildet (durch Abgliederung des *bas I* vom Pleurum), so daß die *BAS*- (= *bas II*-) Bewegung ebenfalls eine "Führung" (in diesem Fall nach medial) erhielt (vgl. unten).

#### Die Ableitung der Neoptera

Wie bei den Ephemeroptera ist auch der Flügelschlagmechanismus der Neoptera durch eine Verstärkung des TWM und Reduktion des TPM gekennzeichnet. Im Gegensatz zu den Eintagsfliegen liegen die Membraneinschnitte (Tergalspalte), die zur Effektivierung der Hebelbewegung im Tergalrand entstanden, jedoch weiter vorn, etwa auf der Höhe des hinteren pleuralen Flügelgelenkes *b*. Die tergale Aufwölbung und Abflachung wird über das dort liegende Pterale 1 auf den Flügel übertragen — auch in den Fällen, in denen (wie bei Hymenopteren, Dipteren und Lepidopteren) ein kaudal des Tergalspaltes liegender Scutellarhebel die Hebelfunktion ganz übernimmt. Tergalspalt, Scutellarhebel und Hebelsklerit sind demnach bei Ephemeropteren und Neopteren analoge Bildungen; der TWM beider Gruppen ist unab-

hängig von der hypothetischen Ausgangskonstruktion abzuleiten (Abb. 24a→d). (Weitere Argumente gegen eine Evolution des Antriebssystems der Neoptera aus ephemeropteroiden oder odonatoiden Systemen — oder umgekehrt gegen die Entwicklung der Flugapparate der Eintagsfliegen und Libellen aus Neopteren-ähnlichen Konstruktionen — sind in den vorhergehenden Kapiteln angeführt.)

Die Ableitung des Basalar-Systems der Neopteren erscheint auf den ersten Blick schwieriger als im Falle der Ephemeropteren, da der Sklerit *BAS* primär, als Bestandteil des Flügels, auf einem Kreisbogen um die Achse *A/B* "außerhalb" des Körpers (!) bewegt wurde (Abb. 24a und 25a), die Basalarsklerite der rezenten Neoptera dagegen in den Thorax hinein bewegt werden (Abb. 24d und 25c). Eine kontinuierliche Transformation der einen Bewegungsbahn in die andere (über funktionsfähige Zwischenstadien, d.h. ohne Funktionsstillstand) ist jedoch dann möglich, wenn man annimmt, daß der vordere Gelenkkopf durch die Bildung eines im Pleurum liegenden Gelenkes *f* in der Vorgeschichte der Neopteren zunehmend nach medial beweglich wurde (Abb. 25a→c). Der vordere Basalarsklerit der Neoptera (*bas I*) wäre dann als eine pleurale Neubildung, der hintere Sklerit *bas II* dagegen als Rest des (ursprünglich pteralen) *BAS* anzusehen (Abb. 24d). Verglichen damit erscheinen andere Denkmöglichkeiten für eine Entstehung der Neopteren-Basalaria weniger plausibel: Theoretisch könnten z.B. beide Basalarsklerite (*bas I* und *bas II*) aus dem Skleriten *BAS* "herausgeschält" worden sein. Wegen der oben erwähnten Schwierigkeit, die Bewegung des *BAS* "nach außen" kontinuierlich in eine Bewegung "nach innen" überzuleiten, ist dies jedoch wenig wahrscheinlich. Die Muskeln müßten in diesem Fall in komplizierter Weise um die *BAS*-Kante herum nach innen gewandert sein, was ohne drastische Funktionsveränderung und -Schwächung (Reduktion der *BAS*-Bewegungsmöglichkeit) nicht vorstellbar ist. (Aus dem gleichen Grund kann auch die Entwicklung des Odonaten-*BAS* nicht von einer neopteroiden Form mit zwei nach innen beweglichen *BAS*(!)-Skleriten ausgegangen sein. Eine Umkehrung der in Abb. 25a→c dargestellten Leserichtung — *c*→*a*, mit Fortsetzung zum TPM — ist andererseits unwahrscheinlich; s. auch S. 85.) Für die oben dargestellte Neubildung des *bas I* aus dem Pleurum spricht aber auch die komplizierte Muskelausstattung der Neopteren-Basalaria. Neopteren besitzen näm-

<sup>1)</sup> Matsuda 1970, l.c. S. 120) gibt für den *t-cx4* einerseits (fälschlicherweise) das Pterale 1 (hier *Pt1*,) als Ansatzpunkt an, andererseits (für *Oligoneuriella* und *Caenis*) einen kleinen, vor dem Pterale 1 liegenden Skleriten ("supplementary plate"). Vielleicht wurde der Odonatenmuskel *hca* (*t-cx4'*) aus diesem Grund als Abkömmling des *vca* (*t-cx4*) angesehen (l.c. S. 398).





Abb. 25. Herausbildung des 1. Basalarsklerits (basI) aus dem Pleurum bei Neopteren (Querschnitte durch den vorderen Flügel- und Thoraxbereich). Der gebogene Pfeil gibt die Bewegungsrichtung des proximalen HP-Gelenkpunktes c beim Abschlag (Kontraktion des Basalarmuskels) wieder. Pleurum schwarz, Sklerit BAS gekreuzt schraffiert (weitere Sklerite zwischen BAS und Tergum in (a) und (b) weggelassen). HP in (c) nur als Sklerotisierung der Flügelunterseite (Verstärkung der Sehne des Basalarmuskels) erhalten. Teg?: Tegula, möglicherweise der letzte (dorsale) "Rest" des BAS. Vgl. auch Abb. 24.

lich Muskeln, die von den Basalarskleriten aus an das Tergum ziehen (bei Mickoleit, 1969, die Muskeln 1 und 2; bei Matsuda, 1970, t-p7, t-p9); sie setzen in manchen Gruppen (z.B. Pleopteren) noch deutlich am vorderen Basalare basI an (ursprünglicher Fall!)<sup>1)</sup>. Weder bei Ephemeropteren noch bei Odonaten sind Muskeln vorhanden, die von einem zum BAS-Skleritbereich gehörigen Teil aus ans Tergum ziehen; solche Muskeln wären, bei Vorliegen einer Homologie des Flügelabschnittes BAS und der Basalaria (bas I und II), zumindest für die Urform der Pterygota ("TPM + TWM") zu fordern (wo für sie allerdings keine Funktion ersichtlich ist). Interessanterweise besitzen die Ephemeropteren aber noch einen pleurotergalen Muskel (t-p10 bei Matsuda, 1970; Pm<sub>11</sub> bei Brodskyi, 1970), der unterhalb von (a) — also nicht an einem Teil des BAS-Systems — entspringt (vgl. S. 87). Wahrscheinlich wurde ein entsprechender (eventuell homologer) Muskel, der ursprünglich als Verspannmuskel zwischen Pleurum und Tergum vorhanden war, im Verlauf des an der Neopterenbasis ablaufenden Prozesses der Angliederung von bas I an bas II

(den Rest des Sklerits BAS) den primär nur senkend wirksamen BAS-Muskeln "hinzugefügt" (s. Abb. 25).

Im TWM-Antriebssystem der Neopteren verlor der vordere pleurale Gelenkkopf mit der Bildung des Gelenkes f seine Bedeutung — z.T. wohl auch im Zusammenhang damit, daß der vordere Tergalrand in der Tierlängsrichtung gegenüber den Basalaria beweglicher werden mußte (vgl. S. 81). Dabei kam es zu einer Reduktion dorsaler, ursprünglich mit dem Tergalrand in Beziehung stehender Bestandteile des BAS (und evtl. anderer, vermittelnder Sklerite?); nur die Tegula blieb anscheinend, als letzter Rest, bestehen (Abb. 25c<sup>2)</sup>). Die auf die Flügelunterseite gewanderte (bzw. nur dort sklerotisierte) Humeralplatte HP überträgt bei Neopteren, wie in den anderen Gruppen, die Zugkräfte der (abschlagenden) Basalarmuskeln auf den Flügel. Sie kann als Sklerit weitgehend

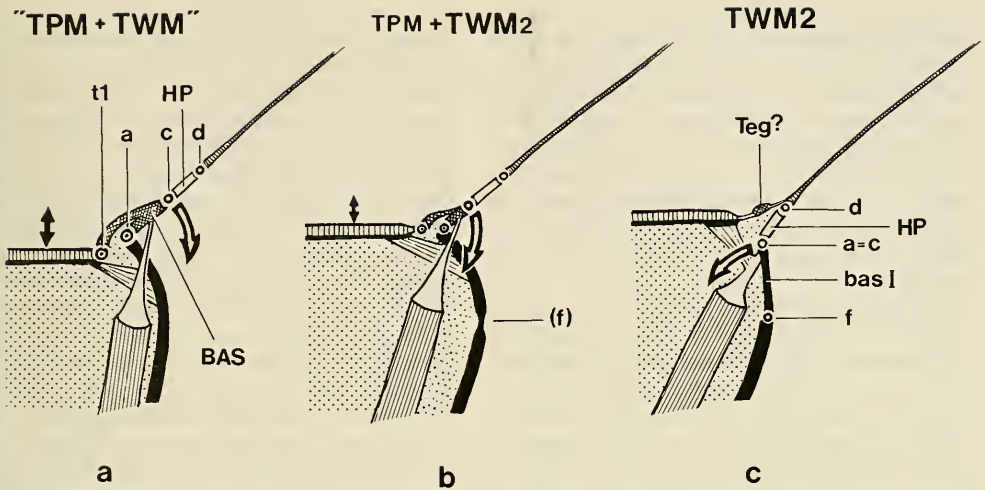
<sup>2)</sup> Dabei muß hier vorerst offenbleiben, ob die Tegula dem dorsalen Bereich vCP-phCP der Odonaten-Costalplatte entspricht oder dem Randsklerit RS (oder einer bei Odonaten vorhandenen Tegula-ähnlichen Struktur; (vgl. Fußnote S. 87<sup>2)</sup>). Die Sub-tegula (= vTS bei Libellen) gibt sich dagegen in allen drei Pterygotengruppen durch ihre Lage und dem Ansatz des Tergopleuralsmuskels (tp) zu erkennen (vgl. S. 87f.).

<sup>1)</sup> Die Beziehung zum basI kann sekundär verwischt sein; die Muskelausätze sind z.B. bei Dipteren auf ein von beiden Basalarskleriten aus ins Körperinneres gewandertes Apodem gelangt.

verschwinden und Sehnencharakter erhalten (z.B. bei Orthopteren). Im ursprünglichen Fall (etwa bei Plecopteren) behielt die Humeralplatte proximal noch eine deutliche Beziehung zum (bei Neopteren vorn sekundär verschmälerten) Sklerit bas II bei (Abb. 24d); in anderen Gruppen besteht dagegen eine Verbindung zum bas I (wie in Abb. 25c) oder zu beiden Skleriten. Im einzelnen haben die Basalaria (wie auch ihre Muskeln) innerhalb der Neoptera starke Abwandlungen erfahren.

Reduktion des TPM (und damit des vorderen, pleuralen Schlaggelenks a), Veränderung des BAS-Systems und Verstärkung des TWM waren wahrscheinlich eng miteinander verknüpft. So konnte die Lage des Sklerits BAS (bzw. seines Restes bas II) z.B. erst nach der Reduktion des Schlagscharniers a/b verändert werden; zu einem früheren Zeitpunkt wäre eine Wanderung des kaudalen bas II-Endes zusammen mit dem Gelenk e vom Fulcrumgelenk b nach ventral ( $\rightarrow e$ ) nicht möglich gewesen, da die unterhalb des Sklerits BAS verlaufende Schlagachse A/B nicht überschritten werden konnte. Diese Entwicklungen standen wahrscheinlich weiterhin in einem Zusammenhang mit der Evolution einer wesentlichen Bewegungsmöglichkeit des Neopterenflügels, der Zurückfaltbarkeit in den Mittelplattengelenken ("Neopterie"). Im Gegensatz zu den Ephemeropteren, bei denen der "Scutellarhebel" weiter kaudal angreift, und der Flügel (infolge der Entlastung des Pterale 1 von der Hebelfunktion) nach vorn "faltbar" werden konnte, liegt die tergale Hebelstelle bei Neopteren auf der Höhe des Schlaggelenkes b, wodurch eine ähnliche Entwicklung von vorn herein verhindert war. Stattdessen wurde in diesem Fall eine Faltmöglichkeit nach hinten evolviert. Die dafür wesentlichen Mittelplattengelenke (zwischen Pterale 2 und Mittelplatte 1 und zwischen Mittelplatte 1 und Mittelplatte 2; in Abb. 24d gestrichelt) entstanden innerhalb des Flügels, was diese Bewegung, verglichen mit der Faltbewegung der Eintagsfliegen, mechanisch unabhängiger vom Schlagantrieb machte. Gleichzeitig wurde die Flügelbasis kaudal-medial membranisiert (vgl. Abb. 22) und gab so dem vorn mit der Mittelplatte 1 in Verbindung stehenden Pterale 3 den notwendigen Bewegungsspielraum.

Obwohl über die ursprüngliche Funktion der Neopteren-Basalaria und ihrer Muskulatur vorerst (ohne eingehenden Vergleich der verschiedenen Gruppen) noch wenig Sicheres ausgesagt werden kann, ist es wahrscheinlich, daß sie

schon früh in einem Zusammenhang mit der Neopterie standen — ohne Veränderung des BAS-Systems (d.h., wenn der Sklerit BAS in der Flügelfläche "liege geblieben" wäre), wäre die Entwicklung der Neopterie wohl nicht möglich gewesen. Die in der Abb. 25 rekonstruierte Evolution der Basalarsklerite der Neoptera zeigt, daß die Krafrichtung der (anfangs reinen) Senkermuskeln des Sklerits BAS (Abb. 25a) allmählich verändert wurde ( $\rightarrow b \rightarrow c$ : Entstehung einer Kraftkomponente nach medial). Die Pterale-3-Muskeln, die den Flügel in den Mittelplattengelenken zu falten vermögen, d.h., nach hinten-innen schwenken, bewegen die (frontal-medial des Falt-Drehpunkts liegende) Gelenkstelle c des Basalarsystems aber zwangsläufig in die entgegengesetzte Richtung, nach vorn-außen, und dehnen somit die vorderen Senkermuskeln. D.h.: die Muskeln des BAS erhielten — zusätzlich zu ihrer persistierenden Funktion als Abschlagsmuskeln — eine Flügelvorziehfunktion. Die Flügelbasis mußte bei der Entwicklung der Neopterie also nicht nur im mittleren bis hinteren Bereich, sondern gleichzeitig auch vorn stärker verändert werden, da ja primär nicht nur zurück-, sondern auch vorziehende Muskeln (wenn dies auch bei einigen rezenten Gruppen nicht mehr zu erkennen ist) beteiligt waren. In der Literatur wird dagegen das Augenmerk hauptsächlich auf die Faltbarkeit des Neopteren-Flügels nach kaudal gerichtet. Als evolutiver Vorteil dieser Fähigkeit wird immer wieder angeführt, daß sie eine Flügel-Ruhelage über dem Abdomen ermöglicht, wodurch ein geringerer Körperrumriß (Tarnung) und eine bessere "Versteckschlüpfbarkeit" erreicht würden (Feindschutz). Ein Selektionsdruck in dieser Richtung kann jedoch anfangs noch gar keine Rolle gespielt haben, da die Fähigkeit zur Flügelfaltung sicher sukzessiv entwickelt wurde und daher zunächst nur geringfügig war. Wahrscheinlich entstand die Neopterie dagegen als eine Möglichkeit, den Schlagbahn-Spielraum zu erweitern (nach vorn, d.h. zu horizontalen Schlagbahnen hin, durch Basalarmuskeln — nach hinten, zu steileren Schlagbahnen hin, durch Pterale-3-Muskeln). Sie diene so primär einer Verbesserung der Manövrierfähigkeit; die Funktion "Ruhelage" (= Extremstellung der Flügel) konnte der ursprünglichen Funktion erst später (als bereits eine weit entwickelte Neopterie vorlag) hinzugefügt werden.

Da der Flügel bei seiner Faltung nach kaudal gleichzeitig eine pronatorische Drehung



durchführt — seine (distale) Vorderkante wird bei der Bewegung in den sich vorn in einem Punkt treffenden Mittelplattengelenken zwangsläufig nach unten bewegt (in der Ruhelage ist der Flügel daher maximal proniert) — ist er bei steileren Schlagbahnen automatisch stärker proniert als bei flacheren. Dies stellte wahrscheinlich (im Zeitraum der Herausbildung der Neopterie) eine wesentliche, aerodynamisch günstige Funktionskopplung dar. Bei den rezenten Neopteren findet sich das Schlagbahn-Stellsystem (= Faltgelenk-, Pterale-3- + Basalar-System) jedoch in vielfältiger Weise abgewandelt, so daß auch einzelne Funktionen oder Funktionskopplungen sekundär entfielen. Während die ursprüngliche Funktion (Veränderung der Schlagbahn) etwa noch bei Hymenopteren, Dipteren und Lepidopteren vorhanden ist, wurde sie in anderen Gruppen (z.T. nur in einem der beiden Flügelpaare) wieder reduziert (vgl. Pfau, 1977b, 1978a; Pfau & Honomichl, 1979); die Möglichkeit der Ruhefaltung der Flügel über dem Abdomen blieb in den meisten Gruppen erhalten (Ausnahme Tagfalter). Die als ursprünglich anzusehende phasische Abschlags-Teilfunktion der Basalarmuskeln wurde in mehreren Gruppen der Neoptera beibehalten, entweder zusammen mit der Vorziehfunktion (z.B. Hinterflügel der Caelifera) oder — bei mechanischer Festlegung einer vorgezogenen Schlaglage des Flügels — als Hauptfunktion (Coleoptera). Sie konnte auch mit anderen (wahrscheinlich neuen) Funktionen kombiniert werden (z.B. im Vorderflügel der Caelifera; vgl. unten). Toni-sche Basalarmuskeln können dagegen als sekundäre reine Stellmuskeln mit reduzierter Antriebsfunktion, die den Flügel v.a. in einer Schlaglage halten, angesehen werden; Schlagbahnveränderungen werden in diesem Fall anscheinend durch die zum Tergum ziehende Basalar-Muskulatur (Muskeln des bas I, s. weiter oben) erreicht (vgl. Pfau, 1977 a).

Die Basalarmuskeln der Neopteren wurden bisher, aufgrund ihres vor dem Fulcrum liegenden Zugpunktes, v.a. als Pronatoren gedeutet und als solche für die Pterygoten verallgemeinert (Snodgrass, 1929, 1935). Eine pronatorische Funktion der Muskeln des BAS-Systems war nach dem hier Dargelegten aber ursprünglich in keiner der drei Pterygoten-Hauptgruppen entwickelt (und damit auch nicht bei der postulierten Ausgangsform "TPM + TWM"). Die Existenz pronatorischer Basalarmuskeln, etwa beim Feldheuschrecken-Vorderflügel (vgl. Abb. 22), kann als eine Sonderentwicklung in-

nerhalb der Neopteren angesehen werden. Auch bei den Heuschrecken läuft der Flügel-Drehmechanismus jedoch nicht (wie Snodgrass annahm) als Antagonismus pronatorischer Basalarmuskeln und supinatorischer Subalarmuskeln, die den Flügel (als Ganzes) um das Fulcrum drehen, ab (einer solchen Bewegung steht bei Neopteren das Tergum/Pterale-1-Längsgelenk entgegen), sondern als Verwindungsmechanismus innerhalb des Flügels. Dafür mußten neue Gelenke evoluiert werden; außerdem mußte die Flügelschlagbahn (durch elastische Mechanismen) festgelegt werden, so daß die aerodynamisch ungünstige Kombination einer flachen Schlagbahn mit einer (beim Abschlag) verstärkten Pronation vermieden wurde (zu Einzelheiten der Vorderflügelmechanik der Feldheuschrecken vgl. Pfau, 1977b, 1978a, 1983; Pfau & Nachtigall, 1981).

#### 4. DISKUSSION UND ERGÄNZUNGEN

##### FLÜGELMECHANIK, MUSKELFUNKTIONEN UND AERODYNAMISCHER EFFEKT

Einige Muskeln des Flugapparates der Libellen können als weitgehend reine Muskeln des Schlagantriebssystems, mit nur einer Funktion, angesehen werden. Dies gilt für den 1. Basalarmuskel bas1 (vgl. S. 50) und den 1. Dorsoventralmuskel dvm1 (mit einer Einschränkung, vgl. S. 60). Auch die zugfederartig wirkenden "Einstellmuskeln" bas2, dvm2 und tp (s.S. 45f.) sind "monofunktionell". Unter den Muskeln für Flügeldrehbewegungen und Schlagbahnänderungen sind der Fulcroalarmuskel fa (s.S. 54ff.) und der dorsale Längsmuskel dlm (S. 60f.) als weitgehend monofunktionelle Stellmuskeln anzusehen (der dlm hätte jedoch — wenn er auch außerhalb des hier postulierten Einsatzbereichs kontrahiert wäre — eine weitere Wirkung; vgl. S. 100).

Andere Muskeln sind gleichzeitig mehreren mechanischen Systemen zugeordnet ("polyfunktionelle" Muskeln). Bei zwei dieser Muskeln (sub1 und sub2; s.S. 50f.) kann man — wenn man die Hebelarme vergleicht — relativ leicht zwischen einer Haupt- und einer Nebenfunktion unterscheiden: der 1. Subalarmuskel ist in erster Linie ein Senker (mit supinatorischer Nebenfunktion), der 2. Subalarmuskel supiniert den Flügel dagegen hauptsächlich (und ist mit Nebenfunktion Senker). Schwieriger ist die Unterscheidung von Haupt- und Nebenfunktion beim vorderen und hinteren Coxoalar- und beim 3. Subalarmuskel (vca, hca, sub3). Die



beiden Coxoalarmuskeln werden hier (trotz ihrer deutlichen Aufschlagswirkung) v.a. als spezialisierte Supinations- bzw. Pronationsmuskeln der Schlagwendepunkte angesehen (andere Muskeln kommen nicht in Frage bzw. erscheinen weniger geeignet; vgl. S. 50ff.). Der wohl tonische sub3 könnte als Supinator sowohl beim Aufschlag (S. 56) als auch an der unteren Schlagwendedrehung beteiligt sein (s.S. 98); als Flügelsenker arbeitet er beim Aufschlag außerdem den Antriebsmuskeln entgegen.

Im Libellenflugapparat existieren demnach zwar mechanisch weitgehend unabhängige Bewegungssysteme für die Schlag- und Stellbewegungen (s.S. 34ff.), die vorhandene Muskulatur ist jedoch z.T. zwischen den Systemen angeordnet und bewirkt zwangsweise gekoppelte Bewegungen. Im weiteren soll zunächst die Bedeutung der funktionellen Trennung der Bewegungssysteme allgemeiner diskutiert werden (dabei werden auch die verschiedenen Möglichkeiten zur Beeinflussung der Flügelgeschwindigkeit erörtert); auf die Funktions-„Überschneidungen“ der Systeme wird dann v.a. in den folgenden Diskussionskapiteln eingegangen. An verschiedenen Stellen wird auch die aerodynamische Wirkung bestimmter Muskeln diskutiert. Zu diesen (hypothetischen) Folgerungen muß gesagt werden, daß sie von einer „stationären Aerodynamik“ und den dabei üblichen Kräfteparallelogrammen (vgl. Weis-Fogh & Jensen, 1956; Nachtigall, 1968; Nachtigall in Kaestner, 1972; Dubs, 1979) ausgehen; instationäre Effekte, die z.B. bei raschen Anstellwinkeländerungen auftreten können, spielen wahrscheinlich zusätzlich eine nicht geringe Rolle — ihr Anteil kann vorerst höchstens geschätzt werden (vgl. z.B. Norberg, 1975). Auch die wechselseitige aerodynamische Beeinflussung der Vorder- und Hinterflügel, neuerdings von Azuma et al. (1985) für den langsamen, stetigen Steigflug von *Sympetrum frequens* analysiert, kann hier keine Berücksichtigung finden.

#### Funktionelle Trennung von Flugmotor und Stellmechanismen

Zur Veranschaulichung der Bedeutung voneinander unabhängiger Antriebs- und Stellsysteme sei zunächst einmal angenommen, ein Insekt könne nur die Leistung des Schlagantriebs („Flugmotors“) durch unterschiedlich starke Muskelkontraktionen verändern. Dadurch könnte zwar die Anströmung am Flügel (die sich aus Schlagwind und Fahrtwind ergibt) und auch die am Flügel angreifende Luftkraft (L)

verändert werden, jeder Schlaggeschwindigkeit käme aber nur eine bestimmte Luftkraft zu. Vortrieb (V) und Auftrieb (A), in die sich die Luftkraft zerlegen läßt, würden sich damit zwar bei einer Veränderung der Schlaggeschwindigkeit vergrößern oder verkleinern, könnten jedoch nicht unabhängig voneinander variiert werden. Das Tier wäre in seinen Flugfähigkeiten stark begrenzt, vergleichbar etwa einem einfachen Gummimotor-Flugmodell, das bei Konstanthaltung des Auftriebs (horizontaler Geradeausflug) weder beschleunigt noch verlangsamt fliegen kann. Andererseits wäre bei einem Insekt, welches nur die Flügelanstellung aktiv zu variieren vermag, und dessen Schlagantrieb konstant ist, eine ähnlich eingeschränkte Flugfähigkeit zu erwarten. Sind Flügel-Antrieb und -Anstellung dagegen beide unabhängig voneinander veränderlich — d.h., der Flügel kann in einer bestimmten Anstellung mit verschiedener Geschwindigkeit geschlagen werden und umgekehrt bei einer bestimmten Schlaggeschwindigkeit unterschiedlich angestellt sein — so erweitert sich der Spielraum der Luftkrafterzeugung beträchtlich. Größe und Richtung der Luftkraft werden weitgehend frei wählbar, die Luftkraftkomponenten A und V dadurch (bis zu einem gewissen Grad) voneinander unabhängig. Dieser Gesichtspunkt ist bisher (sicher auch wegen der nur unzureichend untersuchten Mechanik der Flügel-Stellbewegungen) kaum beachtet worden: Wilson & Weis-Fogh (1962) sahen z.B. bei *Schistocerca* (Orthoptera) die mesothorakalen Basalar- und Subalarmuskeln gleichzeitig als Abschlags-„Powermuskeln“ und antagonistische Einstellmuskeln der Flügelanstellung an (gemäß Snodgrass, 1929; vgl. auch S. 91). Sie fanden also bei den direkten Senkern eine Zwangskopplung einer Antriebsfunktion mit einer Stellfunktion vor. Pronation und Supination laufen jedoch im Vorderflügel der Feldheuschrecken als Flügel-Verwindungen im Flügel, unabhängig von der Antriebsmechanik, ab und können durch einen (weitgehend) schlagneutralen Muskel (den Pterale-3-Muskel = M85) eingestellt werden (vgl. Abb.22 und Pfau, 1977b, 1978a). Auch für die Feldheuschrecken ergäbe sich demnach (bei Berücksichtigung der Vorderflügel allein) die Möglichkeit der unabhängigen Variation von Vortrieb und Auftrieb. Vom Antrieb unabhängige Systeme zur Veränderung der Flügelanstellung sind bei den besser fliegenden Pterygoten anscheinend die Regel (s. auch Abb.22; und Pfau, in Vorb.).

Libellen haben mehrere Möglichkeiten, die Schlaggeschwindigkeit ihrer Flügel zu steuern: Steigerungen der vom Flugmotor abgegebenen Leistung können z.B. durch kräftigere Kontraktion der Antriebsmuskeln und/oder Verstärkung durch weitere, synergistische Muskeln erreicht werden. Beim Abschlag steht allerdings nur ein einziger "reiner" Senker zur Verfügung, der *bas1*, während eine Kontraktion des *sub1* oder *sub2* gleichzeitig eine Flügel-Supination mit sich bringt. Infolge dieser Funktionskopplung erscheinen die beiden Muskeln *sub1* und *sub2* für eine Steigerung der aerodynamischen Abschlagswirkung in doppelter Hinsicht geeignet — sie erhöhen einerseits die Abschlagsgeschwindigkeit (v.a. der *sub1*) und wirken andererseits gleichzeitig der (dadurch verstärkten — s.S. 51) passiven Pronation entgegen (v.a. der *sub2*), wodurch der aerodynamische Anstellwinkel vergrößert oder gleichgehalten wird (vgl. Abb.26a). Theoretisch könnte die Libelle daher entweder mit dem einen direkten (reinen) Senker *bas1* (und mehr oder weniger großem aerodynamischen Anstellwinkel, bestimmt durch den *sub2*) oder allein mit dem anderen, starken Senker *sub1* (der den Anstellwinkel selbst, "automatisch", groß hält) fliegen. Eine Erhöhung der Geschwindigkeit des aufschlagenden Flügels kann wohl nur durch eine stärkere Kraftentwicklung im *dvm1* erreicht werden (der teil-synergistische *hca* kommt wahrscheinlich, aufgrund seiner Drehwirkung im Abschlagsdrehbereich, erst am oberen Schlagwendepunkt ins Spiel — der *vca* aus entsprechenden Gründen am unteren; vgl. S. 50f., S. 95 und S. 97f.). Drosselungen des Flugmotors sind andererseits durch kleine, tonische Zusatzmuskeln ("Zugfeder"-Antagonisten) möglich (S. 45f.). Eine Verringerung der Flügel-Abschlagsgeschwindigkeit kann durch den *dvm2* bewirkt werden; der *bas2* (und auch der *sub3*) wirkt entsprechend auf den aufschlagenden Flügel. Die Schlagamplitude wird durch diese Muskeln demnach entweder oben oder unten gekürzt; außerdem könnten Phasenverschiebungen zwischen dem rechten und linken Flügel entweder erzeugt oder ausgeglichen werden. Die Wirkung der *tp* auf die Flügelgeschwindigkeit ist dagegen komplexer. Diese Muskeln beeinflussen sowohl den Aufschlag als auch den Abschlag; sie sind jeweils in der ersten Schlagphasenhälfte Antagonist, in der zweiten Synergist der (jeweiligen) Antriebsmuskeln. In welcher Weise dies äußerlich zum Ausdruck kommt, hängt sicher we-

sentlich von der zeitlichen Entwicklung der Kraft in den Powermuskeln ab.

Diese Steigerungs- und Drosselungsmöglichkeiten des Libellen-Flugmotors ergeben einen weiten Spielraum der Luftkraftherzeugung nach beiden Seiten hin, einerseits bei der symmetrischen Kraftherzeugung, andererseits auch (bis zu einem gewissen Grad; vgl. S. 43 und S. 45f.) bei rechts-linksseitig asymmetrischen Steueraktionen. Das sind Möglichkeiten, die für derartig hoch spezialisierte Lufträuber sicher von größter Bedeutung sind.

#### Veränderung der Flügelanstellung in den beiden Schlagphasen

Die beiden mechanisch ganz unterschiedlichen Drehbereiche des Flügels sind in der mittleren Anstellung durch Anschläge voneinander getrennt (s.S. 46ff.). Die Supinatoren des Abschlagsdrehbereichs können daher nicht in den Aufschlagsdrehbereich "hinüberwirken" und umgekehrt der Pronator des Aufschlagsdrehbereichs nicht in den Abschlagsdrehbereich. Es ist andererseits (aus energetischen und — da ungünstige Flügelverformungen die Folge wären — wohl auch aerodynamischen Gründen) nicht wahrscheinlich, daß den Flügel entgegengesetzt verwindende Muskeln gleichzeitig aktiv sind, da der Flügel dabei von vorn und hinten unter Spannung gesetzt würde (eine bereits vorhandene Verwindung würde jedoch nicht rückgängig gemacht). Drehungen in Richtung Anstellxtrem können demnach erst dann beginnen, wenn die Verwindung im anderen Drehbereich bis zum Anschlag (0°) zurückgenommen ist. Diese Rückdrehungen im einen Drehbereich, und anschließenden Vorwärtsdrehungen im anderen, spielen sich an den Schlagwendepunkten ab und werden z.T. durch spezielle Muskeln, z.T. aber auch durch passive Kräfte, beeinflusst (s.S. 97f.). Innerhalb der Schlagphasen werden wahrscheinlich andere Muskeln für Anstelländerungen eingesetzt, wobei jedoch für einzelne Muskeln vorerst nicht klar entschieden werden kann, ob sie mehr der Einstellung der Flügelanstellung in der Schlagphase oder mehr der Beeinflussung der Drehgeschwindigkeit am Schlagwendepunkt dienen. Für diese Muskeln sollen daher beide Möglichkeiten erörtert werden.

Muskeln zur Vergrößerung des aerodynamischen Anstellwinkels. — Der 2. Subalarmuskel (*sub2*) wird wahrscheinlich (in Anbetracht seiner gleichzeitigen Abschlagsfunktion) phasisch

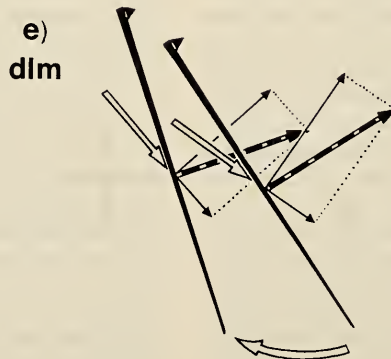
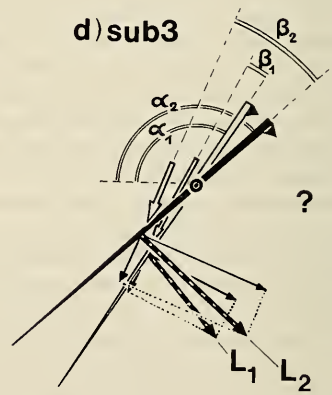
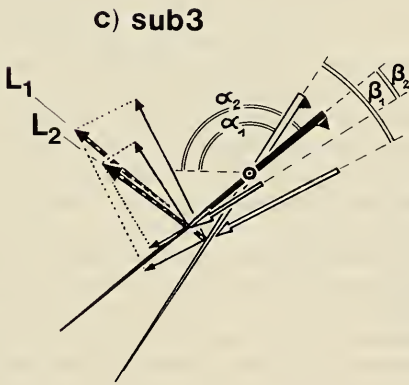
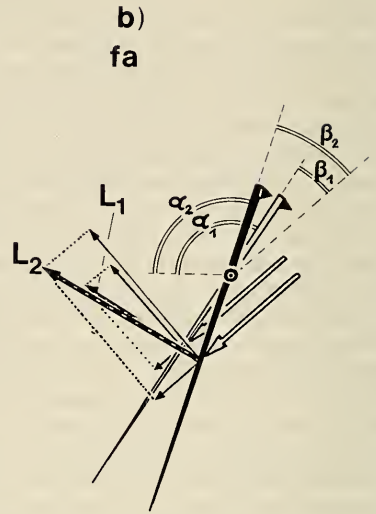
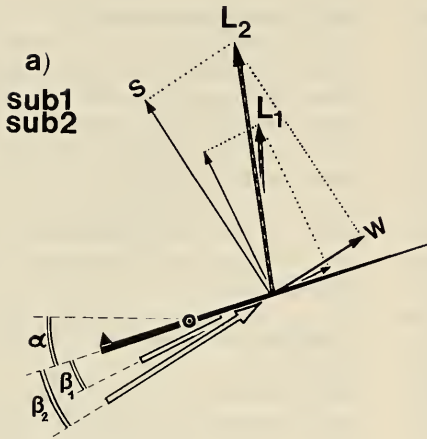



beim Abschlag eingesetzt. Theoretisch könnte er auch phasisch beim Aufschlag kontrahiert werden; er wäre dann aber lediglich ein Synergist des *bas2* (s.S. 45), da er die Flügelanstellung im Aufschlagsdrehbereich wohl nicht zu beeinflussen vermag (s.S. 56)<sup>1)</sup>. Der 2. Subalarmuskel besitzt einen großen Hebelarm zur Drehachse des Abschlagsdrehbereichs und einen kleinen zur Schlagachse. Da bei einer Kontraktion des Muskels beim Abschlag eine Flügel-Supination mit einer Erhöhung der Flügelgeschwindigkeit einhergeht, wird die aerodynamische Wirkung des Abschlags in zweifacher Hinsicht gesteigert (vgl. S. 93 und Abb. 26a). Zusammen mit dem 1. Subalarmuskel eingesetzt (bei dem die Abschlagswirkung größer, die Supinationswirkung dagegen kleiner ist als beim *sub2*), ergibt sich eine Möglichkeit zur Erweiterung des Bereichs der Luftkrafterzeugung (vgl. S. 92f.).

Im Gegensatz zum *sub1* und *sub2* erscheint der *vca* für eine positive Veränderung der Luftkraft in einem mittleren Abschlagsabschnitt weniger geeignet zu sein, da er den Flügel gleichzeitig abbremsen und den Effekt des vergrößerten aerodynamischen Anstellwinkels vermindern (oder aufheben) würde (vgl. auch S. 51). Der vierte Flügel-Supinator, der *sub3*, könnte theoretisch (phasisch kontrahiert) den aerodynamischen Anstellwinkel beim Abschlag vergrößern und würde dabei (wie der *sub1* und

*sub2*) gleichzeitig die Schlaggeschwindigkeit erhöhen. Dieser Muskel ist jedoch vergleichsweise schwach und wird hier — da er mit großer Wahrscheinlichkeit tonisch ist und (als einziger Muskel) den Cubitalsektor supinatorisch zu bewegen vermag — der Aufschlagsphase und dem Aufschlagsdrehbereich zugeordnet (vgl. S. 56 und weiter unten).

Der Fulcroalarmuskel (*fa*) vergrößert den aerodynamischen Anstellwinkel beim Aufschlag. Ein Hinüberwirken in den Aufschlagsdrehbereich wird als unwahrscheinlich angesehen, da die Muskelwirkung durch den pronatorischen Anschlag des Cubitalsektors begrenzt ist; im Aufschlagsdrehbereich wird der RAP-interne Muskel (infolge der beweglichen Aufhängung seines Ursprungs — genau am Gelenk *p2* der RAP-Drehachse *P2/C4*) als Ganzes zusammen mit der RAP bewegt, so daß hier den Muskel dehrende Gegenkräfte fehlen (vgl. S. 55f.). Im Gegensatz zum *sub2* des Aufschlagsdrehbereichs ist der *fa* schlagneutral. Möglicherweise muß daher bei einer Änderung seiner Kontraktionsstärke auch die Schlaggeschwindigkeit des Flügels verändert werden (entsprechend wie beim *sub2*, der die Geschwindigkeit "automatisch" vergrößert); bei Zunahme der *fa*-Kraft könnte dies z.B. durch *dvm1*-Verstärkung (oder schwächere Kontraktion des *bas2*) erreicht werden.

Muskeln zur Verkleinerung des aerodynamischen Anstellwinkels. — Der 3. Subalarmuskel (*sub3*) ist als tonischer Muskel in der Aufschlagsphase wirksam und beeinflusst die Flügel-

<sup>1)</sup> Auf eine phasische Kontraktion des *sub2* beim Abschlag deutet auch ein Ausschalt-Experiment von Neville (1960) hin.

Abb. 26. Schemata zur Luftkrafterzeugung. — (a) Vergrößerung des aerodynamischen Anstellwinkels ( $\beta$ ), des Anström-Vektors und der Luftkraftresultierenden (L) bei Kontraktionsverstärkung des *sub1* oder *sub2* in der Aufschlagsphase. Der geometrische Anstellwinkel  $\alpha$  wurde hier unverändert belassen. Dies beinhaltet die Annahme, daß (v.a. im Falle einer *sub1*-Kontraktion) das passiv-pronatorische Drehmoment (hervorgerufen durch den größeren Windfahneffekt bei größerer Flügelgeschwindigkeit) das supinatorische Drehmoment (bedingt durch die Muskelkontraktion) gerade kompensiert (vgl. auch S. 50f.); (b) Verkleinerung von  $\alpha$  und damit verbundene Vergrößerung von  $\beta$  und L bei Kontraktionsverstärkung des *fa* in der Aufschlagsphase. Der Anströmvektor wurde unverändert belassen; (c) Verkleinerung von  $\beta$ , L und Anström-Vektor (bei gleichzeitiger Richtungsänderung desselben — als Folge der Schlagverlangsamung) durch verstärkte *sub3*-Kontraktion in der Aufschlagsphase; (d) Möglichkeit der Rücktriebssteigerung bei sehr starker *sub3*-Kontraktion und Anströmung der Flügelunterseite in der Aufschlagsphase. Dabei wurde angenommen, daß die Luftkraft L, trotz verringerter Anströmgeschwindigkeit, durch die Vergrößerung von  $\beta$  größer wird. Die Vergrößerung von  $\beta$  ist sowohl durch die supinatorische Flügeldrehung als auch durch die Richtungsänderung der Anströmung bedingt. Wegen der Erzeugung von Abtrieb ist es fraglich, ob (d) beim Flug zum Einsatz kommt; (e) Zwei Phasen der Vorschwingbewegung (des Anisopteren-Vorderflügels) am Ende des Abschlags. Die Abb. verdeutlicht die Möglichkeit der Erzeugung von Rücktrieb durch den *dlm*.

$\alpha$  geometrischer Anstellwinkel (Winkel zwischen einer Frontalebene und dem Flügel);  $\beta$  aerodynamischer Anstellwinkel (Winkel zwischen Luftanströmung und Flügel); L Luftkraftresultierende; S Seitkraft; W Widerstand. Das schwarze Dreieck an den Flügelquerschnitten kennzeichnet die Vorderkante und Oberseite.

anstellung dort (sobald der 0°-Anschlag des Abschlagsdrehbereichs erreicht ist — vgl. S. 98) durch eine supinatorische Bewegung des Cubitalsektors (s.S. 56). Theoretisch wäre der Muskel damit als Antagonist des *fa* anzusehen; es ist jedoch fraglich, ob er als solcher auch eingesetzt wird (d.h., ob er zu gleicher Zeit wie der *fa* kontrahiert wird), da er den Flügel ja vor allem dann zu supinieren vermag, wenn die pronatorischen Gegenkräfte gering sind. Der *sub3* verwindet den Flügel in Richtung zur aerodynamischen Null-Anstellung (tangentiale Anströmung) hin, vielleicht sogar darüber hinaus (→ Anströmung der Flügelunterseite). Während durch den *fa* (v.a.) die Vortriebswirkung vergrößert wird (s. Abb. 26b und weiter unten), wird sie durch den *sub3* verkleinert — bei gleichzeitiger Verringerung der Aufschlagsgeschwindigkeit (vgl. S. 56; Abb. 26c)! Erreicht der Flügel, bei Anströmung der Flügelunterseite, negative Anstellwinkel, so kann evtl. sogar Rücktrieb erzeugt werden (Abb. 26d). Da Flügelaufschläge mit wenig oder ohne Vortriebswirkung (oder mit Rücktrieb) wahrscheinlich beim langsamen Flug und Rüttel- bis Rückwärtsflug eingesetzt werden, ist zu erwarten, daß der *sub3* v.a. in diesen Flugsituationen kontrahiert wird (zusammen mit dem *dlm*? Vgl. S. 100).

Bei Libellen liegt damit eine getrennte Einstellmöglichkeit der Flügelanstellung in der Ab- und Aufschlagphase vor, die für die Manövrierfähigkeit der Tiere sicher von großer Bedeutung ist. Da die Grundschlagbahnebene des Flügels durch ein Scharniergelenk (*p1/p2*) festgelegt ist, wird der Flügel beim Ab- und Aufschlag in der weitgehend gleichen Bahn bewegt (vgl. S. 43f.). Daraus ergibt sich für die beiden Schlagphasen (bei positivem aerodynamischem Anstellwinkel) eine ganz unterschiedliche Ausrichtung der auf dem Flügel stehenden Luftkraftresultierenden (s. Kräfteparallelogramm der Abb. 26a und b); bei Zerlegung von *L* in *A* und *V* wird ersichtlich, daß beim Abschlag mehr Auftrieb als Vortrieb erzeugt wird, beim Aufschlag dagegen mehr Vortrieb als Auftrieb. Ausgestattet mit der Fähigkeit, die Flügelanstellung in den beiden Schlagphasen unabhängig zu bestimmen, können Libellen daher entweder die Auftriebs- oder die Vortriebserzeugung betonen (oder natürlich auch beide zugleich, und dies entweder rechts-linksseitig symmetrisch oder asymmetrisch<sup>1)</sup>) — wiederum eine wesentliche Möglichkeit zur Erweiterung

des Spielraums der Luftkraftherzeugung!

Die den aerodynamischen Anstellwinkel vergrößernden Muskeln *sub2* und *fa* besitzen beide (im mittleren Abschnitt ihrer Schlagphase) anscheinend keinen Muskel-Antagonisten — ihr "Gegenspieler" ist jeweils die den Flügel (passiv) zur Anströmung hin drehende Luft (vgl. S. 51, 55). Diesem Gesichtspunkt wurde wohl bisher deshalb keine Beachtung geschenkt, weil die Verwindungsmechanik (und -muskulatur) bei keiner Gruppe genauer untersucht war und somit auch Informationen über die genaue Lage der Flügeldrehachse(n) fehlten. Die in der vorliegenden Arbeit dargestellten Befunde zeigen, daß im Odonatenflügel die Achsen beider Drehbereiche so liegen, daß sich die Hauptflügelfläche — und damit (wie bei einer Wetterfahne) auch der aerodynamische Druckpunkt — jeweils hinter der Achse befindet. Aufgrund dieses "Wetterfahneffekts" wird der aerodynamische Anstellwinkel des Flügels bei Änderung der Anströmung gewissermaßen selbsttätig in einem günstigen Bereich gehalten. Größere Anstellwinkel müssen jeweils aktiv, mit Muskelkraft (gegen die Luft), erzeugt werden.

In beiden Schlagphasen ist der Flügel verwunden, und zwar so, daß er distal stärker proniert oder supiniert angestellt ist als proximal. Hierin könnte eine Anpassung an die sich von proximal nach distal ändernde Richtung und Geschwindigkeit der anströmenden Luft gesehen werden: Da die Flügel-Umfangsgeschwindigkeit nach distal zunimmt, ändern sich auch Winkel und Stärke der aus Fahrtwind und Schlagwind resultierenden Anströmung zur Flügelspitze hin; dies wird durch die Verwindung des Flügels möglicherweise (zumindest zum Teil) kompensiert, so daß der aerodynamische Anstellwinkel unterkritisch bleibt. Im Abschlagsdrehbereich wird der Flügel deutlich geringer verwunden als im Aufschlagsdrehbereich. In Übereinstimmung damit scheint zu

1) Für unilaterale Veränderungen der Flügelanstellung scheint v.a. der schlagneutrale *fa* geeignet zu sein, da bei einer einseitigen Kontraktionsänderung der Flügelschlag des anderen Flügels nicht beeinflusst wird. Jedenfalls nicht direkt: wird durch die Korrektur der Flügelanstellung gleichzeitig die Flügelschwindigkeit (passiv, durch die geänderte Anströmung) verändert, so ist natürlich der andere Flügel — indirekt, über die tergeale Kopplung — mitbetroffen.



stehen, daß die Abschlagsgeschwindigkeit des Flügels kleiner ist als die Aufschlaggeschwindigkeit (vgl. den Film von v. Holst, 1950; Nachtigall in Kaestner, 1972; Savage et al., 1979, nach Daten von Norberg, 1975).

Da das Ausmaß der Flügelverwindung von zahlreichen Kräften abhängt (von den Stellmuskeln und von der Luftanströmung direkt — von den Antriebsmuskeln, welche über die Veränderung der Flügel- und Fluggeschwindigkeit die Anströmung verändern, indirekt), läßt das äußerliche Bild eines mehr oder weniger verwundenen Flügels (Abb. 27) für sich keine Rückschlüsse auf den Kontraktionszustand der Muskeln zu. Es ist außerdem noch völlig offen, in welcher Weise sich der Flügel genau bei unterschiedlichen aktiven und passiven Kräften verwindet (und sonst verformt). Hier können in Zukunft nur experimentelle Untersuchungen, die zahlreiche Faktoren berücksichtigen, eine weitere Aufklärung erbringen.

#### Schlagwendepunkte

Norberg (1975) kam zu dem Ergebnis, daß ein großer Teil der Auftriebskräfte beim Libellen-Rüttelflug von den Wendepunktsdrehungen des Flügels herrührt. Der aerodynamische Mechanismus ist jedoch bisher weitgehend unbekannt. Möglicherweise wird der sog. "flip mechanism" (Weis-Fogh, 1973) genutzt<sup>1)</sup>. Savage et al. (1979) wiesen dagegen auf andere Mechanismen hin: die Autoren zeigten anhand von

Modellexperimenten, daß bei rüttelfliegenden Libellen die Supination der unteren Schlagwendepunktsdrehung — über Wirbelbildung bzw. Sogwirkung an der hinteren und vorderen Flügelkante — einen großen Anteil an der Auftriebserzeugung hat.

Aktive Wendepunktsdrehungen haben wohl zumindest die Bedeutung, daß der Flügel möglichst rasch in eine der Abschlags- oder Aufschlaganströmung "angepaßte" Anstellung geschwungen wird und so schon von Beginn an in der Schlagphase Luftkräfte erzeugen kann — ein rein passives Umschwingen würde wahrscheinlich Verluste mit sich bringen. Andererseits kann die Flügeldrehgeschwindigkeit durch eine spezialisierte "Wendepunktmuskulatur" variiert werden, so daß Phasenunterschiede der Flügel beider Seiten erzeugt (oder ausgeglichen) werden können; dies dürfte für Steueraktionen von Bedeutung sein.

Für die Pronation der oberen Schlagwende steht den Libellen (nach Ausschluß des bas1 — vgl. S. 50) nur der im Abschlagsdrehbereich pronatorische, wahrscheinlich phasisch-aktive

<sup>1)</sup> Dabei könnten elastische Verspannungen im Flügel (z.B. bei früher Kontraktion des hea) eine Rolle spielen. Ein in beiden Hälften der Schlagwendedrehung den Flügel entgegengesetzt verwindender, einen bistabilen Effekt erzeugender Muskel (vgl. Pfau & Nachtigall, 1981: Subalararmuskel im Vorderflügel von *Locusta*) war bei Libellen jedoch nicht nachweisbar.



Abb. 27. Männchen von *Aeshna cyanea* im Rüttelflug. Man beachte den stark supinatorisch verwundenen, aufschlagenden rechten Hinterflügel sowie den weit vorgeschwungenen, am Abschlagsende befindlichen rechten Vorderflügel.



hca zur Verfügung (s.S. 44, 50). Der Muskel besitzt zusätzlich eine Aufschlagwirkung. Am Auf-Abschlags-Umkehrpunkt kontrahiert, bewirkt er demnach — da er auch die Aufschlagbewegung des Flügels fortsetzt und die obere Amplitude vergrößert — für sich wohl keine wesentlich beschleunigte Pronationsdrehung<sup>1)</sup>. Schnellere Drehbewegungen des Flügels sind deswegen aber nicht ausgeschlossen; sie könnten durch einen (gegenüber der hca-Kontraktion) verfrühten Einsatz der Abschlags-Antriebsmuskeln erreicht werden. Dabei würde der aufschlagende Flügel zunächst abgebremst und dann abgeschlagen; der sich (spät) kontrahierende hca würde weniger schnell verkürzt (isometrische Kontraktion), so daß der Flügel rascher ("auf der Stelle") proniert würde. Wahrscheinlich wird der Muskel sub2 erst nach dem hca, innerhalb der Abschlagsphase, kontrahiert (vgl. S. 93ff.); bei frühzeitigem Einsatz könnte er allerdings ebenfalls an der Wendepunktsdrehung beteiligt sein — er würde in diesem Fall den Drehwinkel und die Drehgeschwindigkeit (im Abschlagsdrehbereich) verkleinern.

Der vca wird hier als Supinator der unteren Schlagwende betrachtet (s.S. 51). Da der Muskel (der wie der hca medial von der Schlagachse am Flügel angreift) zusätzlich eine Aufschlagfunktion besitzt, bremst er den Flügel bei seiner Kontraktion ab (im Gegensatz zum hca, s. oben). Der Flügel wird dadurch schnell, praktisch auf der Stelle, bis zum 0°-Anschlag des Abschlagsdrehbereichs hin supiniert (die Muskelwirkung wird wohl dadurch noch gesteigert, daß der vca bis zum Ende der Schlagphase durch die Abschlagsbewegung gedehnt wird — dies steht wiederum im Gegensatz zum hca). Eine verlängerte Wendedrehung (bei gleichzeitig weiter fortgesetztem Flügelschlag — wie sie der hca allein bewirken kann, s. oben) kann durch einen schwächeren Einsatz des vca und wohl auch durch stärkere (bzw. späte) Kontraktion von Abschlagsmuskeln erreicht werden. Der Muskel sub3 vermag (als tonischer Muskel) die Supination des unteren Schlagumkehrpunktes fortzusetzen (Zugfederwirkung mit beginnendem Aufschlag; vgl. S. 56). In diesem Fall wären die Kräfte zweier gleichsinnig drehender Muskeln aus verschiedenen Drehbereichen (vca,

sub3) hintereinandergeschaltet. Würde der Supinator des Abschlagsdrehbereichs (vca) dagegen nicht kontrahiert, so würde der sub3 — infolge seines Hebelarms zur Drehachse P2/C4 — zu Beginn des Aufschlags auch den ersten Teil der Drehung übernehmen. Für den Muskel fa muß ebenfalls eine Beeinflussung der unteren Wendepunktsdrehung erwogen werden: der Muskel würde (bei tonischer Kontraktion oder im Falle eines frühen phasischen Einsatzes) entsprechend wie der sub2 (vgl. oben) den Drehwinkel und die Drehgeschwindigkeit des Flügels (in diesem Fall im Aufschlagsdrehbereich) verkleinern. Setzt der Muskel fa dagegen phasisch erst sehr spät ein, so wäre er an der oberen Wendepunktsdrehung — wiederum nur in dem zum Aufschlagsdrehbereich gehörigen Teil der Drehung — pronatorisch beteiligt.

Demnach besitzen die Odonaten mit den Muskeln hca und vca eine spezialisierte Muskulatur für die Flügeldrehbewegungen des oberen und unteren Schlagwendepunkts. Da außer diesen Muskeln aber noch weitere beteiligt sein können (fa, sub2, sub3), und auch passive Kräfte sicher eine nicht unwesentliche Rolle spielen, kann im einzelnen mit sehr komplexen Kraftbeziehungen und vielfältigen Bewegungsabläufen gerechnet werden.

Funktionsmorphologische und experimentelle Untersuchungen weisen neuerdings auch für andere Insektengruppen darauf hin, daß den Schlagwendepunktsdrehungen (oder zumindest einer von beiden, also entweder der pronatorischen oder der supinatorischen Drehung) eine größere Bedeutung zukommt. Bei *Locusta* ist z.B. die Pronation des oberen Schlagumkehrpunktes in vielfältiger und komplexer Weise aktiv beeinflussbar (Pfau, 1977b, 1978a, 1983; Pfau & Nachtigall, 1981, s. Fußnote S. 97). Hier spielen drei Muskeltypen (Basalarmuskeln, Subalarmmuskel und Pterale-3-Muskel) eine Rolle und können, je nach Kontraktionskraft und -zeitpunkt, die Drehbewegung modifizieren; die als wesentliche "Initiator"-Pronatoren eingesetzten Basalarmuskeln sind in diesem Fall gleichzeitig starke Senker des Flügelantriebssystems (vgl. dazu auch S. 91 und Abb. 22). Die Supination des unteren Schlagwendepunkts läuft dagegen bei *Locusta* (und auch bei *Cetonia* und *Geotrupes*; vgl. Pfau & Honomichl, 1979) in relativ einfacher Weise, weitgehend passiv, ab: sowie der Flügel langsamer wird und pronierende Kräfte abnehmen, schwingt er in eine elastisch bedingte supinierte Grundanstellung zurück. Demgegenüber sind die Dipteren (*Cal-*

<sup>1)</sup> Im Insekten-Flugfilm von v. Holst (1950) zeigt der linke Vorderflügel der Libelle (anscheinend *Aeshna juncea* L.) eine solche, einen größeren Abschnitt der Aufschlagphase einnehmende "verlängerte" pronatorische Wendepunktsdrehung.



Abb. 28. Grunds Schlagbahnebene und Möglichkeiten zur Schlagbahn-Veränderung beim Vorderflügel der Anisopteren (a,b) und der Zygopteren + Anisozygopteren (c). In (a) und (b) wurde die postulierte "Vorbereitung" der Vorschwingbewegung — durch Kontraktion des vca vor dem dlm (s. S. 60f.) — illustriert; (a) Schwache Kontraktion des dlm (evtl. zusätzlich schwache vca-Kontraktion) → großer Schlagbahnwinkel  $\lambda_1$  am Ende des Abschlags (der Flügel schwingt etwa in der Fortsetzung der Grunds Schlagbahn aus); (b) Starke Kontraktion des dlm (und vca) → kleiner Winkel  $\lambda_2$  am Abschlagsende; (c) Schema der Wirkung des dlm und pa bei Zygopteren und Anisozygopteren (vgl. S. 61).

*liphora*) anscheinend wie die Libellen in der Lage, auch am unteren Umkehrpunkt des Schlags einen Wendepunktswinkel (Supinator) einzusetzen (pt<sub>4</sub> in Abb. 22); bei rein tonischer Kontraktion würde dieser Muskel allerdings — entsprechend wie der sub<sub>3</sub> der Odonaten — erst zu Beginn des Aufschlags wirksam (vgl. Pfau, in Vorb.). Die bisherigen Befunde zeigen also, daß bei den Pterygoten mehrere, ganz unterschiedliche Wendepunktswinkelmechanismen evolviert wurden.

#### Veränderung der Schlagbahn

Das Flügel-Vorschwingen ist von anderen Bewegungen abhängig (vgl. S. 57ff.). Es kann z.B. erst dann beginnen, wenn der Flügel sich in einer bestimmten Anstellung ( $0^\circ$  = "zwischen" den Drehbereichen) befindet. Ist er proniert angestellt, muß dem Vorschwingen demnach eine Supination vorausgehen; ein Überlappen der Vorgänge würde beide Bewegungen "schwierig" (weniger effektiv) machen. Die Funktion der tergalen Hebelkette ist andererseits von der sich im Schlagablauf verändernden Ausrichtung der Scharnierachse C2/C4 abhängig und kann erst in der unteren Hälfte des Schlags

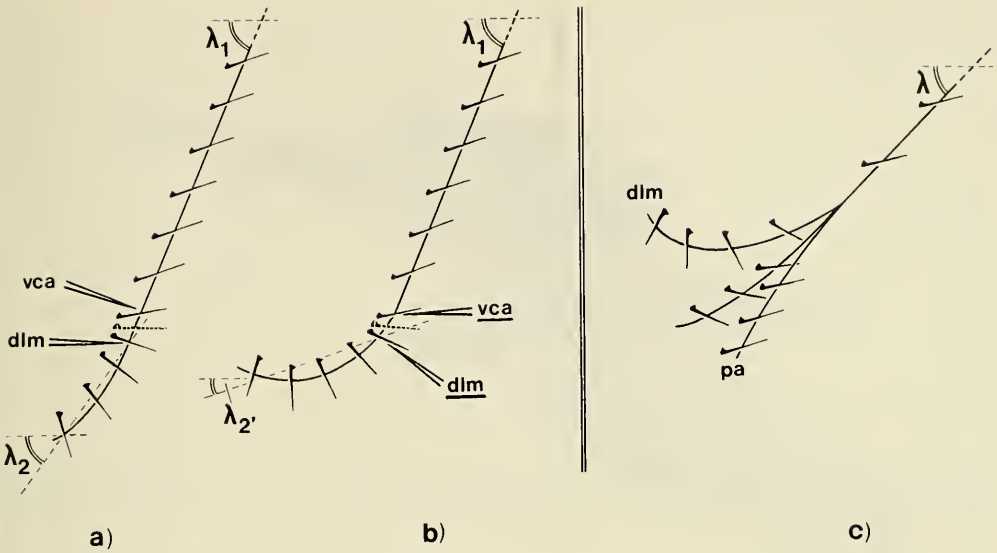
"ablaufen"; vorher ist ein vollständiges Vorschwingen des Flügels, bis hin zum Anschlag der dhCP an der phCP, nicht möglich. Beim Aufschlag schließlich verhindert der starke indirekte Heber dvm1 ein Vorschwingen — ein (phasischer) Einsatz des dlm kann daher in dieser Phase als unwahrscheinlich angesehen werden. Der Kontraktions-Zeitpunkt der dorsalen Längsmuskeln läßt sich also auf den unteren Abschlagsabschnitt, anschließend an eine supinatorische Drehung bis  $0^\circ$  (vca), eingrenzen; dabei ist zu erwarten, daß die durch den dlm bewirkte Schlagbahnänderung je nach der Kontraktion des Supinators verschieden ausfällt (vgl. S. 60f. und Abb. 28a, b). Dieses (aus der Mechanik erschlossene) zeitlich enge Zusammenwirken der beiden Muskeln dlm und vca erklärt möglicherweise einen Irrtum Neville's (1960): Neville beobachtete, daß die Flügelbasisplatten RAP und CP am Abschlagsende auseinanderweichen und schrieb dies (aufgrund der etwa gleichzeitig stattfindenden, die vca-Kontraktion anzeigenden Bewegung des Randsklerits RS nach ventral) einer Kontraktion des Muskels vca zu (wobei er sich allerdings z.T. widersprüchlich äußert — s. Anm. 17, S. 116).



Abb. 29. Flügel-Vorschwingen bei *Aeshna cyanea* (nach einer Sequenz des Films von G. Rüppell, 1981; Tier in Großaufnahme, Abdomenende außerhalb des Bildes). Eineinhalb aufeinanderfolgende Schläge des linken Vorderflügels eines rüttelfliegenden Männchens sind dargestellt: ▼ Aufschlag 1, △ Aufschlag 1, ● Aufschlag 2 (Flügelspitzenbahn). Da das Tier danach eine Roll- und Gierbewegung durchführte, konnte der folgende Aufschlag nicht mehr verfolgt werden. Der Flügelumriß wurde nur für beide Aufschlags-Endpunkte (für denselben Vorderflügel) ausgezeichnet, der Hinterflügel wurde weggelassen. Die Pfeile kennzeichnen den jeweiligen Beginn der Supinationsdrehung. Die Abstände zwischen den letzten vier Punkten des 2. Aufschlags sind perspektivisch verkürzt, da der vorschwingende Flügel schließlich nach innen-oben (vom Betrachter weg) ausschwingt. Die in diesem Fall einseitig (links) durchgeführte Steueraktion wirkte anscheinend einem Wegdrehen des Tiers nach rechts entgegen (die dorsalen Längsmuskeln dlm sind bei nur einseitig weit abschlagendem Flügel v.a. auf der Seite der großen Amplitude wirksam; vgl. S. 58). Schlagfrequenz ungefähr 31 Hz; Bildfrequenz 460 Bilder/sec.

Der dlm, der ein Auseinanderweichen der Basisplatten allein zu bewirken vermag, wurde von Neville jedoch nicht berücksichtigt.

Die aerodynamische Wirkung einer am Abschlagende zunehmend horizontal und dann auch nach oben führenden Flügelbahn könnte in einer Veränderung der Ausrichtung der Luftkraftresultierenden  $L$ , die mehr und mehr nach oben und dann auch nach hinten zeigt, gesehen werden (Abb. 26e). Dadurch würde zunehmend Rücktrieb erzeugt, was bedeuten würde, daß der dlm beim Abbremsen des schnellen Vorwärtsflugs oder beim Rüttel- und Rückwärtsflug eingesetzt wird; die in der Abb. 30 nach Schnappschüssen umgezeichneten Momentaufnahmen freifliegender Tiere, sowie Abb. 29, eine Szene aus einem Libellenflugfilm von Rüppell, können als Belege dafür angesehen werden. Das Flügel-Vorschwingen ist, aufgrund der schräg zur Flügelfläche stehenden Achse C2/C4, mit einer supinatorischen Bewegungs-

Komponente verknüpft, die dafür sorgt, daß die Anstellung im Verlauf der Vorschwing-Bewegung allmählich verändert wird (vgl. Abb. 26e und 28 und S. 59). Dies könnte als eine automatische Anpassung an die sich gleichzeitig ändernde Richtung der Luftanströmung interpretiert werden. Das auf das Vorschwingen folgende Zurückschwingen des Flügels soll hier nicht näher untersucht werden; in diesem Fall ist die weniger stabile Flügelhinterkante "führend". Für die Beurteilung des daran anschließenden (eigentlichen) Aufschlags ist wesentlich, ob der dlm phasisch kontrahiert wurde oder tonisch ist. Ein tonischer dlm würde beim Aufschlag (v.a. zu Beginn, da die dlm-Wirkung später "gesperrt" ist) dem dvm1 antagonistisch gegenüberstehen (vgl. S. 60; Abb. 9e, f); er würde die Aufschlagsgeschwindigkeit verringern, da ein Teil der dvm1-Kraft gegen den dlm aufgewandt werden müßte. Auf einen Schlagabschnitt mit Rücktriebserzeugung (Vorschwin-

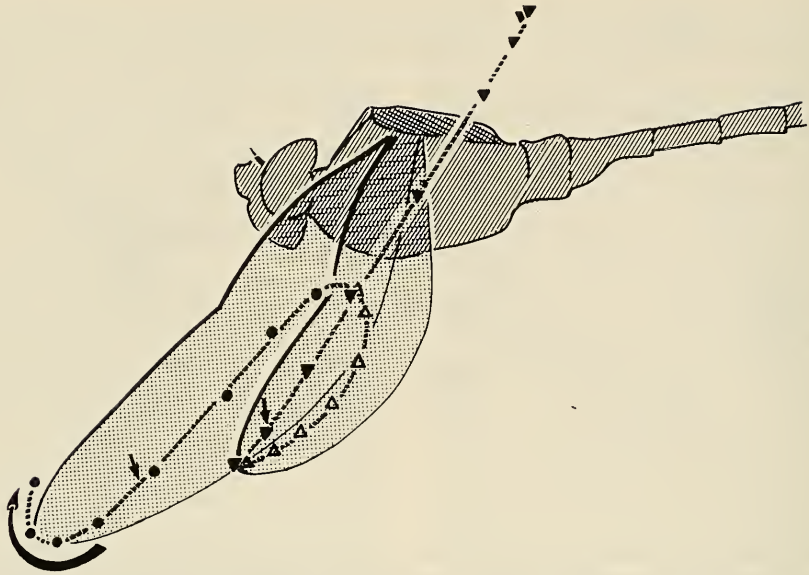



Abb. 30. Eierlegende *Sympetrum striolatum* — langsamer Manövrierflug auf engem Raum (nach geblitzten Aufnahmen). Beim oberen Paar zeigt das Männchen, beim unteren das Weibchen weit vorgeschwungene Vorderflügel.

gen) würde also eine Phase mit verminderter Vortriebswirkung (Aufschlag) folgen.

Verglichen mit Zygopteren und Anisozygopteren (vgl. S. 61f.) sind die Anisopteren sicher darin als abgeleitet zu betrachten, daß Veränderungen der Schlagbahn nur beim Vorderflügel stattfinden können; nur der Mesothorax besitzt einen kräftigen dlm, nur beim Vorderflügel ist im Gelenk c2/c4 ein weites Vorschwingen möglich. Im Metathorax ist der dlm bis auf ein winziges Längsmuskel-Rudiment, das an einem sehr kurzen Hebelapodem angreift, reduziert; das Metatergum ist außerdem kaum verformbar, die Beweglichkeit des Flügels im c2/c4-Gelenk stark eingeschränkt. Der Muskel pa fehlt bei Anisopteren in beiden Segmenten. Bei den Zygopteren und bei der Gattung *Epiophlebia* können dagegen Vorder- und Hinterflügel eine Vor-Zurückschwingbewegung ausführen, der Hinterflügel allerdings mit einer stark abweichenden Mechanik und einem gegenüber dem Mesothorax "umgekehrten" Muskelantagonismus. In beiden Thoraxsegmenten stehen pro Flügel (den dvm1 nicht gerechnet) zwei antagonistische Muskeln zur Verfügung (dlm und pa). Dies deutet darauf hin, daß bei diesen Libellen der Schlagbahnwinkel  $\lambda$  der Vorder- und Hinterflügel — ausgehend von einer gegenüber Anisopteren mehr horizontal stehenden Grund-Schlagbahnebene (vgl. S. 43f.; Abb. 28) — nach beiden Seiten hin verändert werden kann. Eine Vergrößerung des Winkels würde mehr Vortrieb erbringen, eine Verkleinerung mehr Auftrieb bis Rücktrieb. Beim Anisopteren-Vor-

derflügel, dessen Grund-Schlagbahnebene steiler steht, ist dagegen nur eine Verkleinerung von  $\lambda$  möglich (vgl. auch S. 109f.<sup>1)</sup>).

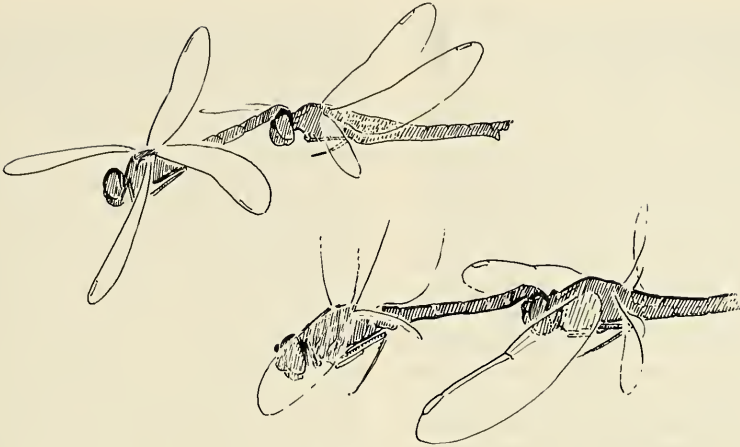
#### SENSORISCHE KONTROLLE UND FLUGSTEUERUNG

Über die Sinnesorgane des Flug-Steuerungssystems der Libellen existieren bisher nur wenige experimentelle Untersuchungen. Sie betreffen v.a. Rezeptoren aus nicht-thorakalen Körperbereichen, z.B. Rezeptoren im Halsbereich und Augen (Mittelstaedt, 1950), Windrezeptoren am Kopf (Sveshnikov, 1973) und Antennen (Gewecke et al., 1974).

Im folgenden sollen einige Überlegungen zur funktionellen Bedeutung der hier untersuchten Flügel-Mechanorezeptoren angeschlossen werden. Da diese bis jetzt nur auf die funktionsanatomische Analyse und relativ wenige elektrophysiologische Ableitungen (v.a. Summenableitungen) gegründet werden können, müssen sie als vorläufig angesehen werden. Für weitere Aufschlüsse sind v.a. Untersuchungen an ein-

<sup>1)</sup> Der Muskel fa kann nicht als ein Antagonist des dlm betrachtet werden, da er beim Vorschwingen (ähnlich wie beim Flügelschlag oder bei der Pronation im Abschlagsdrehbereich, vgl. 55f.) als Ganzes zusammen mit der RAP bewegt wird (auch die Auslenkung des Fulcrum — vgl. S. 58 f. — dehnt den Muskel höchstens minimal). Der fa ist bei Anisopteren außerdem im Metathorax (in dem der Vorschwing-Mechanismus reduziert ist!) normal entwickelt.

zelen Sensillen notwendig; auch Ableitungen an vor dem Windkanal fliegenden Tieren müßten durchgeführt werden.

Die im Kapitel 2 (S. 62ff.) dargestellten Befunde zur Beanspruchung der Mechanorezeptoren lassen darauf schließen, daß sowohl das Chordotonalorgan als auch die beiden Reihen campaniformer Sensillen für die Kontrolle der Flügeldrehbewegungen um die Längsachse eingesetzt werden; andere Bewegungen zeigen dagegen keinen Einfluß auf die Rezeptoren, jedenfalls keinen direkten. Beide Rezeptorsysteme werden in beiden Drehbereichen zugbeansprucht, das CH bei den Drehungen von den Anstellextremen ( $S_{\max}$  oder  $p_{\max}$ ) zur mittleren Anstellung ( $0^\circ$ ) hin, die Kutikula der CF1,2-Gebiete dagegen bei Flügeldrehungen in die entgegengesetzte Richtung (CF1:  $0^\circ$  nach  $p_{\max}$ ; CF2:  $0^\circ$  nach  $S_{\max}$ ). Die elektrophysiologischen Untersuchungen ergaben, daß im Falle der campaniformen Sensillen anscheinend nur diese Zugbeanspruchungen der Kutikula (in Längsrichtung der Kutikulargruben) zur Erregung führen, während für das CH sowohl Dehnungen als auch Entdehnungen reizwirksam sind. Das deutet (ebenso wie auch das stark unterschiedliche Erregungsmuster der CH- und CF-Sensillen) darauf hin, daß sich die beiden Rezeptorsysteme funktionell ergänzen (jedoch nicht auf einfache Weise, d.h. nach Drehbereich und Drehrichtung).

Die Ableitungen weisen auf eine unterschiedliche Spezialisierung der etwas 50 Einzelscolopidien des Chordotonalorgans hin. Da das Organ in den beiden Drehbereichen nicht symmetrisch beansprucht wird (s. Abb. 16, 17), könnten die verschiedenen großen Dehn-Entdehnungsgeschwindigkeiten zur Erregung unterschiedlicher Einzelsensillen führen und damit eine sensorische Trennung der Drehbereiche ermöglichen. Vielleicht sind die Drehbereiche aber auch dadurch getrennt, daß der ventrale CH-Ansatz im Abschlagsdrehbereich in einer etwas anderen Ebene bewegt wird als im Aufschlagsdrehbereich (vgl. Abb. 17a), so daß — je nach Ausrichtung — nur ganz bestimmte Einzelscolopidien oder Scolopodialbündel gedehnt bzw. entdehnt werden<sup>1)</sup>. Weiterhin kann man annehmen, daß durch die Dehnungen andere Sensillen erregt werden als durch die Entdehnungen (u.U. eine zweite Sinneszelle im selben Scolopidium<sup>2)</sup>), wodurch auch der Dreh-sinn kodiert wäre. Einige Ableitungen deuten sogar darauf hin, daß bestimmte Sensillen (oder

Sensillengruppen) nur in relativ kleinen Winkelabschnitten innerhalb der Drehbereiche ansprechen (Abb. 19f) oder nur durch ganz bestimmte Dehn- bzw. Entdehnungsgeschwindigkeiten erregt werden (s. die "on-off"-Spikes in den Abb. 18c—e und 19b).

Zur Aufklärung der unterschiedlichen Sensillen-Spezialisierungen müßten Untersuchungen durchgeführt werden, die auch die komplizierte Transformation des Reizes zum CH berücksichtigen, d.h., die tatsächliche jeweilige Einwirkung auf das CH in Rechnung stellen. Selbst bei äußerlich einfachen Reizen kann aus der Drehgeschwindigkeit ja keinesfalls direkt auf die Dehn- bzw. Entdehnungsgeschwindigkeit des Rezeptors geschlossen werden (s. Abb. 17b). So wird die Flügel-Drehbewegung im Abschlagsdrehbereich nur stark unteretzt auf den (kleineren!) Hebel  $v_{\text{CH}}$  weitergegeben — sie wird nicht 1:1 in die für die CH-Beanspruchung wesentliche CoS-Bewegung umgesetzt, da Flügel und RAP auch als Ganzes bewegt werden (vgl. S. 47ff.). Elastische Kräfte wirken zusätzlich modifizierend; die Flügelverwindungen werden z.B. zu den Extremen  $p_{\max}$  und  $S_{\max}$  hin zunehmend durch in der Kutikula entstehende Gegenkräfte erschwert (s.S. 49f., 53f.). Aus diesen Gründen ist zu erwarten, daß das CH (unter der Voraussetzung einer konstanten Drehkraft) bis  $p_{\max}$  relativ langsam und geringfügig entdehnt wird und von da an, bis  $0^\circ$  zurück, eine etwas schnellere Dehnung (bis hin zum Längen-Maximum) erfährt. Die Entdehnung im Aufschlagsdrehbereich ist wohl anfangs noch schneller, wird aber dann zum Verwindungsextrem  $S_{\max}$  hin wieder langsamer; hier ist das Organ am Endpunkt stärker verkürzt als bei  $p_{\max}$  im Abschlagsdrehbereich. Bei der Zurückdrehung zur  $0^\circ$ -Anstellung beschleunigen dann wieder, wie im Abschlagsdrehbereich, elastische Kräfte. Nicht nur die Drehbereiche wären demnach verschieden ("asymmetrisch"), sondern in ihnen jeweils auch die Dehn- und Entdehnvorgänge der Hin- und Zurückdrehung. An den Stellen maximaler äußerer Geschwindigkeit der Sinusdrehungen ( $0^\circ$ , Abb. 17b) gehen die Längenänderungen des

<sup>1)</sup> Eine elektronenmikroskopische Untersuchung (Risler in Vorb.) ergab inzwischen, daß die Scolopidien in verschiedenen Bündeln zusammengefaßt vorliegen. Es zeigten sich dabei auch morphologische Unterschiede zwischen den Scolopidien, die meist nur eine, in einigen Fällen aber auch zwei Sinneszellen enthalten.



Rezeptors jeweils auf Null zurück. Für die natürlichen  $0^\circ$ -Durchgänge der Schlagwendepunkte ist außerdem zu erwarten, daß dort auch die Drehkräfte klein werden; die Anschläge zwischen den Drehbereichen bedingen ja, daß verschiedene Muskeln nacheinander kontrahiert werden müssen, wenn die ganze Drehung aktiv vollzogen werden soll<sup>1)</sup> (vgl. S. 46f.). Möglicherweise sind dies Eigenschaften des Systems, die zur Schonung des bei  $0^\circ$  maximal gedehnten CH beitragen.

Die stark phasischen Sensillen des Chordotonalorgans sind (nach dem oben Dargestellten) nicht nur in der Lage, anzuzeigen, daß Anstellwinkeländerungen stattfinden, sondern könnten darüber hinaus auch Informationen über Drehbereich und -richtung sowie Geschwindigkeit und Dauer liefern. Damit würden sowohl Änderungen der Kontraktion der Drehmuskeln (Pronatoren, Supinatoren) als auch Änderungen der Luftanströmung (auftretende Wirbel beim Abreißen der Strömung etc.!) registriert. Diese Informationen des CH sind im gedehnten Zustand des Organs (um  $0^\circ$ ) anscheinend besonders genau — hier werden die meisten Impulse abgegeben, das Organ reagiert auch äußerst empfindlich. Möglicherweise ist der  $0^\circ$ -Durchgang der Schlagwendepunkte demnach ein wesentlicher Bezugspunkt für die Muskeleinsätze. Da die schnellen Schlagwendepunktsdrehungen des Flügels andererseits wie es scheint an der Luftkrafterzeugung beteiligt sind (Norberg, 1975; Savage et al., 1979), wäre ihre sensorische Kontrolle auch direkt für die Steuerung der Luftkräfte von Bedeutung. Genauere Messungen der Anstellung im  $0^\circ$ -Bereich könnten außerdem beim Segeln wesentlich sein (s. weiter unten). Die große Bedeutung der Flügel-Chordotonalorgane für den Flug konnte durch Ausschaltexperimente, die an frisch gefangenen Tieren im Freiland durchgeführt wurden, demonstriert werden: Bei diesen Versuchen wurden die CH bei verschiedenen Großlibellen (*Aeshna cyanea*, *Anax imperator*, *Orthetrum cancellatum*) in allen vier Flügeln durch Abtrennung von ihren ventralen kutikulären Ansatzstiftchen außer Funktion gesetzt. Die mit einer feinen Nadel vorgenommenen Eingriffe, die nur winzige äußere Verletzungen (fast ohne Austritt von Gewebsflüssigkeit) mit sich bringen, hatten deutliche Veränderungen des Flugvermögens zur Folge: entweder stürzten die Tiere beim

Abflug sofort in Spiralen zu Boden oder sie waren (zwei von insgesamt sechs Exemplaren) nur noch zu einem langsamen, stetigen Steigflug in der Lage.

Die langen Reihen der dicht aneinanderschließenden campaniformen Sensillen auf der Oberseite der RAP, über die bei den Flügel-drehungen von  $0^\circ$  nach  $S_{\max}$  bzw.  $p_{\max}$  Zugspannungen anscheinend von proximal nach distal hinweglaufen (s.S. 64ff. und S. 72ff.), könnten genauere Informationen über Drehbereich, Drehablauf und geometrische Flügelanstellung (im ganzen Winkelbereich) liefern. Wahrscheinlich werden die einzelnen Sensillen nacheinander und jeweils nur in einem kleinen Winkelabschnitt der Drehung erregt. Der Drehbereich würde durch die betroffene Reihe (CF1 oder CF2) angezeigt, die Geschwindigkeit der Drehung durch die Abfolge des Erregungsbeginns der Sensillen, wobei das zuletzt gereizte Sensillum den erreichten Winkelort wiedergeben würde<sup>2)</sup>. Bei den Rückdrehungen zur  $0^\circ$ -Anstellung werden die (nur bei Drehung nach  $p_{\max}$  bzw.  $S_{\max}$  erregten) Sensillen wohl in umgekehrter Folge "abgeschaltet" — mit ähnlichen Möglichkeiten des Informationsgewinns. Das (im Gegensatz zum CH) phasisch-tonische Muster der Einzelsensillen enthält jedoch wahrscheinlich noch weitere Informationen. So bleiben die den Drehvorgängen und erreichten Anstellungen entsprechenden Sensillenerregungen für eine bestimmte Zeit "stehen", wodurch statische Anstellungen — Flügelanstellungen beim Segeln (s. weiter unten) oder auch die Ruhe- und Startbereitschafts-Anstellung (s.S. 56) — perzipiert werden könnten. Darüber hinaus ist evtl. sogar die Messung der aktiven und passiven Kräfte möglich, die — je nachdem, ob sie von proximal oder distal aus, oder auch von beiden Seiten (entgegengesetzt oder gleichsinnig), wirken — unterschiedliche Zugspannungen in der RAP erzeugen<sup>3)</sup>. Ausgangs- und Endzustand und zeitliche Entwicklung der bei einer Flügel-drehung auftretenden kutikulären Spannungen (und der sie verursachenden Kräfte) würden

<sup>2)</sup> Das (schmale) CH erscheint dagegen für genaue Winkelmessungen der Flügelanstellung wenig geeignet.

<sup>3)</sup> Dadurch könnten z.B. auch Überbeanspruchungen der Kutikula angezeigt werden: bei stärkerem Wind stellen Libellen, v.a. die großflügeligen Aeshniden, das Fliegen ein oder weichen in ruhigere Zonen aus.

<sup>1)</sup> Dieser Gesichtspunkt wurde in der Abb. 17b nicht berücksichtigt.



sich im Verhalten der einzelnen Sensillen und im Gesamtverhalten der Reihen ausdrücken (vgl. dazu auch Pfau, 1983, S. 75). Die große Anzahl und enge Stellung der Sensillen und ihre wahrscheinlich überlappenden Bereiche deuten dabei auf einen großen Dynamikbereich für geringe Anstellwinkel- bzw. Kraftänderungen und auf eine hohe Meßgenauigkeit hin. Proximal sind beide Sensillenreihen deutlich verbreitert (Abb. 11, 12). In dieser Region, die hier dem 0°-Anstellbereich zugeordnet wird, liegen die meisten Sensillen; sie adaptieren anscheinend weniger rasch als die distal liegenden Sensillen der extremen Anstellungen (vgl. S. 73). Dies könnte für eine genauere (feiner gestufte) Registrierung mittlerer Flügelanstellungen (und ihrer Kräfte), etwa beim Segelflug, sprechen; die längere "Gebrauchszeit" der Information würde damit übereinstimmen. (Die extremen Flügelanstellungen,  $p_{\max}$  oder  $S_{\max}$ , treten dagegen sicher nur innerhalb der Schlagphasen auf und sind — verglichen mit statischen Anstellungen des Segelflugs — von kurzer Dauer.) Außerdem sind — ähnlich wie beim CH — im 0°-Bereich der Schlagwendepunktsdrehungen besonders genaue Messungen möglich.

Funktionsmorphologische und elektrophysiologische Untersuchungen an *Locusta* haben ergeben, daß auch hier die Flügeldrehbewegungen durch Dehnungsrezeptoren (im Mesothorax ein Streckrezeptor und ein Chordotonalorgan) perzipiert werden können (vgl. Pfau, 1978b, 1983). Beide Rezeptoren sind in einer mittleren Flügelanstellung maximal gedehnt (für den Streckrezeptor konnte dies durch Längenmessungen und elektrophysiologische Ableitungen belegt werden). Die Dehnungsrezeptoren des Vorderflügels von *Locusta* stimmen also in dieser Hinsicht mit dem CH der Libellen auffallend überein (der Streckrezeptor feuert allerdings nur bei Dehnung) — beide sind aber mit Sicherheit nicht dem Libellen-CH homolog! Für die Felder campaniformer Sensillen in der Flügelbasis anderer Pterygoten ergab sich aus funktionsmorphologischen Untersuchungen, daß sie ebenfalls als Meßsysteme der Flügelanstellung eingesetzt werden könnten (vgl. Pfau & Honomichl, 1979: verschiedene Felder in der Flügelbasis von *Cetonia* und *Geotrupes*; Pfau, 1983: Sensillen in der ventralen Basis der Subcosta von *Locusta*<sup>1)</sup>). Ein elektrophysiologischer Nachweis war in diesen Fällen jedoch noch nicht möglich.

## EVOLUTION

### Evolution der Flugapparate und Cladogenese der Pterygoten

Die Flügel-Antriebssysteme der drei Pterygoten-Hauptgruppen konnten zwanglos (d.h. über funktionsfähige Zwischenstadien) von einer Ausgangskonstruktion abgeleitet werden, welche die beiden rezent verwirklichten Antriebsprinzipien TWM und TPM noch in sich vereinte (Kap. 3; Abb. 24). Von diesem Urflugapparat "TPM+TWM" ausgehende Effektivierungen des Flügelantriebs erscheinen nur möglich, wenn entweder der TWM- oder der TPM-Anteil seine Antriebsfunktion verliert, das verbleibende System dagegen weiterentwickelt wird. Damit einhergehend konnten einzelne Bestandteile des von der Antriebsfunktion "befreiten" Teilsystems — in allen drei Pterygotenlinien — für die Entwicklung von Stellmechanismen genutzt werden. Sie wurden wohl (da eine Antriebssteigerung nur dann vorteilhaft ist, wenn auch die Manövrierfähigkeit verbessert wird) gleichzeitig und in wechselseitiger Abstimmung mit dem jeweiligen Antriebssystem evolviert. Bei der Reduktion (bzw. Transformation) des einen Teilmechanismus, und der Effektivierung des anderen, wurde in allen drei Entwicklungslinien nur eine der beiden ursprünglichen Schlagachsen in das neue Antriebssystem einbezogen, die andere wurde entweder aufgegeben oder (modifiziert) in das Stellsystem übernommen.

Odonata. — Bei den Odonaten wurde der TPM-Flügelantrieb weiterentwickelt und der TWM-Anteil reduziert; Vorder- und Hinterflügel konnten damit unabhängig werden. Der Vor- und Zurückschwingmechanismus ging (mit unterschiedlichem Ergebnis in beiden Segmenten) aus dem TWM hervor; er ist damit — ebenso wie der Flügelverwindungsmechanismus im Abschlagsdrehbereich (s.S. 83) — als eine Autapomorphie der Odonaten zu betrachten. Dagegen handelt es sich beim Verwindungsmechanismus des Aufschlagsdrehbereichs möglicherweise um eine Plesiomorphie.

<sup>1)</sup> Gettrup (1966) konnte bei *Schistocerca* einen Einfluß entsprechender (in der Subcosta-Basis liegender) Sensillen des Hinterflügels auf die Anstellung des Vorderflügels nachweisen (intersegmentaler Reflex).

Ephemeroptera. — Die Ephemeropteren effizientierten den TWM, bei gleichzeitiger Reduktion des TPM. Da der TWM hier weit kaudal am Flügel angreift und zu einer steilen Grundscharfbahnene führt, mußte in dieser Gruppe gleichzeitig eine Flügelbeweglichkeit nach vorn (für flachere Schlagbahnen) entwickelt werden: Die Zugrichtung der Basalarmuskeln wurde verändert; im Zusammenhang damit wurde die (ursprünglich einheitliche) Unterseite des Sklerits BAS zweigeteilt — dabei verloren beide Teile (BAS<sub>a</sub> und BAS<sub>b</sub>) ihre Verbindung zum vorderen Gelenkkopf. Die vor dem verbleibenden Schlagelenk b (und proximal vom tergalen Schlagscharnier) liegenden Pteralia 1 konnten als Führungselemente der Schlagbahn-Stellbewegung eingesetzt werden.

Neoptera. — Die Neopteren beschränkten ebenfalls den Weg der TWM-Weiterentwicklung; die tergale Hebelstelle des Flügels wurde jedoch weiter vorn (auf der Höhe des Fulcrum) ausgebildet. Da ein effektiver Flügelschlag bei dieser Anordnung eine geringere Hebelbewegung des Tergum als bei den Ephemeropteren erfordert, war die Entwicklung einer mehr horizontal stehenden Grundscharfbahn der Flügel von vornherein begünstigt. Im Zusammenhang damit (und wohl auch mit der Reduktion des TPM, welcher primär steilere Schlagbahnen ermöglichte; vgl. S. 80f.) wurde die Neopterie, die Beweglichkeit des Flügels nach kaudal, zur Erzeugung steilerer Schlagbahnen evoluiert. Das BAS-System des "TPM+TWM" wurde (durch Einbeziehung eines pleuralen Elements und Reduktion der tergalen Verbindungen) stark abgewandelt; die Antriebsmuskeln des BAS (die vorderen direkten Senker) erhielten eine zusätzliche Funktion als Vorziehmuskeln im Schlagbahn-Stellsystem.

Für die drei rezenten Pterygotengruppen ergeben sich drei verschiedene systematische Gliederungsmöglichkeiten (vgl. etwa Hennig, 1969). Es wurde der Versuch unternommen, synapomorphe Gemeinsamkeiten der Flugapparate zu finden, die eine nähere Verwandtschaft zweier Gruppen belegen könnten. Die Schlag- und Stellsysteme erwiesen sich jedoch in den drei Gruppen als grundsätzlich verschieden und alternativ — es war nicht möglich, zwei Gruppen von einer nur ihnen gemeinsamen Ausgangsform abzuleiten oder Gründe dafür zu finden, daß ein rezenter Flugapparat-Typ selbst als präadaptiv für die Entwicklung eines anderen

anzusehen ist. So spricht z.B. gegen die zunächst naheliegende Ableitung der Ephemeroptera und Neoptera (beide mit TWM-Antrieb) von einer nur ihnen gemeinsamen Ausgangsform, daß in beiden Gruppen unterschiedliche Gebiete des Tergalrandes für die Flügelhebelung spezialisiert sind<sup>1)</sup>. Es ist daher anzunehmen, daß der TWM-Anteil ursprünglich (beim Ausgangsmechanismus "TPM+TWM") noch relativ schwach entwickelt und ineffektiv war; die Hebelzone des Tergum für den TWM war wahrscheinlich zu Beginn noch langgestreckt, so daß beide Entwicklungslinien (und auch die zu den Odonaten führende Linie) unabhängig davon ausgehen konnten.

Dagegen war die Rekonstruktion eines allen drei Gruppen gemeinsamen "Urflugapparates" durchführbar. Daraus kann man den Schluß ziehen, daß die effektiveren Flugapparate (TPM, TWM1 und TWM 2; Abb. 24) in den drei Pterygotenlinien getrennt (unabhängig) entwickelt wurden; d.h., die Evolution ging in den einzelnen Stammgruppen jeweils von einem noch ähnlichen System ("TPM+TWM") aus. Das stark umstrittene Problem der stammesgeschichtlichen Aufspaltung der Pterygoten (vgl. etwa Hennig, 1969; Kristensen, 1975; Matsuda, 1981) erscheint demnach mit Hilfe des Flugapparates nicht lösbar. Die Möglichkeit, alle rezenten Flugapparate von einer Ausgangskonstruktion abzuleiten, spricht aber andererseits für die Monophylie der \*Pterygota (\*vgl. Fußnote S. 76f.), und somit dafür, daß die Flugfähigkeit der Insekten nur einmal entstanden ist!

Die von Matsuda (1981) vorgebrachten Argumente für eine polyphyletische Entstehung der Pterygota und ihrer Flugfähigkeit beruhen größtenteils auf Voraussetzungen, die (nach den hier vorgelegten Ergebnissen) einer Korrektur bedürfen (vgl. dazu auch S. 35f.). In seiner ablehnenden Einstellung gegenüber Verfechtern monophyletischer Gruppenbildungen und hypothetischen Rekonstruktionen von Ahnformen übersieht Matsuda auch, daß selbst di- oder polyphyletische Systeme, falls sie sich begründen lassen, in jeder einzelnen Linie wieder monophyletisch sind, was bedeutet, daß jetzt Rekon-

<sup>1)</sup> Die Konvergenz der beiden TWM-Systeme läßt sich mit Hilfe der Hebel-Pteralia ("Pt4" bzw. Pt1) begründen: die Sklerite liegen verschiedenen Bereichen der Flügelbasis an und sind durch direkt oder in ihrer Nähe ansetzende, nicht-homologe (!), Muskeln gekennzeichnet (s. auch S. 85 und S. 86f.).



struktionen von mehreren "hypothetical common ancestors" notwendig werden. Die Argumente Matsuda's (auf die ich im weiteren eingehen möchte) vermögen eine polyphyletische Entstehung der Pterygota jedoch nicht zu sichern, so daß die Frage nach den verwandtschaftlichen Beziehungen der Pterygoten-Hauptgruppen (also nach der Abfolge der ersten Aufspaltungen) immer noch offen ist.

Im Gegensatz zur Ansicht Matsuda's existieren keine prinzipiellen Schwierigkeiten, die Flugapparate der Odonaten, Ephemeropteren und Neopteren von einer gemeinsamen Ausgangskonstruktion abzuleiten. Die Merkmale, die Matsuda zur Begründung einer getrennten Evolution der Odonata aus Machiliden-ähnlichen Vorfahren anführt (1981, S. 391), stellen, wie er selbst weiß (l.c. S. 391 unten), vorerst reine Ähnlichkeiten dar; es konnten keine Argumente dafür angeführt werden, daß sie echte Synapomorphien sind, also auf einen nur diesen beiden Gruppen (den Machiliden und Odonaten) gemeinsamen Vorfahren zurückgehen. Das als besonders wesentlich erachtete Merkmal "large compound eyes" (l.c. S. 391) erscheint z.B. wenig überzeugend (nicht überzeugender jedenfalls als etwa die borstenförmige Fühlergeißel der Palaeoptera, s. Hennig, 1969); andere Merkmale ("four intratergal apophyses", "pseudoprescutum", "median lobe of labium") müssen — im Hinblick auf ihre Homologie und Verbreitung — überprüft werden (vgl. dazu auch Kristensen, 1975). Die von Matsuda auf Seite 390f. aufgeführten, die Odonaten allein auszeichnenden Merkmale des Flugapparates (die nach seiner Ansicht für eine unabhängige Entwicklung der Libellen sprechen) sind nur zum Teil als autapomorph anzusehen, so etwa das Merkmal "Synthorax"<sup>1)</sup> oder auch das Merkmal Nr. 2: "dorsal extension of the mesepisternum...". Dagegen beruht die Annahme, daß nur bei den Odonaten zwei "Humeralplatten" existieren, auf nicht korrekten Homologisierungen (s. dazu auch S. 41), bzw. darauf, daß offensichtlich nicht damit gerechnet wurde, daß ein Teil des Basalare ursprünglich im Flügel "inkorporiert" vorgelegen haben könnte. Über das Vorhandensein eines dem Pterale 1 homologen Sklerits äußert sich Matsuda widersprüch-

lich (vgl. 1981, S. 391 oben und S. 392 oben; oder 1970, 1979)<sup>2)</sup>. Das Fehlen des 2. und 3. Axillarsklerits bei Odonaten erscheint andererseits nicht verwunderlich; diese Sklerite sind erst mit dem Entstehen der Neopterie in "typischer" Ausprägung zu erwarten — sie fehlen damit bei Odonaten und Ephemeropteren von vornherein (vgl. S. 83f., 86f., 90). Die von Matsuda weiter angeführten Autapomorphien sind entweder problematisch (die hintere Kappensehne und das Fehlen des Subalare; vgl. dazu S. 41) oder können, wie die doppelte pleurale Flügelartikulation (vgl. S. 78ff. und 82ff.) oder das Vorhandensein bzw. Fehlen verschiedener Muskeln, als Plesiomorphien angesehen werden. Zur Beurteilung der Thorax-Muskulatur der Odonaten äußert sich Matsuda allerdings nur vage. Einige dieser Muskeln sind (bei Berücksichtigung der in der vorliegenden Arbeit begründeten neuen Homologievorstellungen) nicht mehr als Odonaten-autapomorph anzusehen, bei anderen ist die Homologie noch unklar (dies betrifft auch einige der auf S. 393 bei Matsuda aufgeführten, die Ephemeropteren und Odonaten unterscheidenden Muskeln und Muskelfunktionen, die jetzt durchaus anders interpretiert werden können). Der Verlust mehrerer Muskeln bei Odonaten erscheint mir übrigens nicht verwunderlich — er wird im Zusammenhang mit der Effektivierung und Ökonomisierung des TPM-Flugapparates verständlich (auch innerhalb der Neoptera kam es in mehreren Linien zu Vereinfachungen und Reduktionen!); im einzelnen muß aber noch untersucht werden, welche Muskeln tatsächlich bei den Odonaten fehlen.

Für eine gemeinsame Evolution der Ephemeropteren und Neopteren (in einer unabhängigen Linie) sprechen nach Matsuda mehrere Merkmale, die alle als im Zusammenhang mit der Entwicklung der Flügel "neu" entstandene Strukturen gedeutet werden. Auch diese Merkmale sind jedoch — in einem anderen Licht gesehen — ganz anders interpretierbar: Die vorgenommene Homologisierung dreier Axillarsklerite bei Ephemeropteren und Neopteren (Punkt (1), l.c. S. 392) ist keineswegs gut begründet; die Axillarsklerite 2 und 3 fehlten bei den Ephemeropteren wohl schon primär (s. oben). — Die als Punkt (2) aufgeführte Pleuralleiste (mit dem Fulcrum und dem darauf ruhenden "2. Axillare") ergibt sich als eine Symple-

1) Zum sog. "Synthorax" der Odonata muß angemerkt werden, daß die Verschmelzung der beiden Flugsegmente nur die Pleura und Sterna betrifft — die Schlag- und Stellsysteme der Flügelpaare sind funktionell unabhängig!

2) Zur möglichen Homologie des Sklerits G1 und des Pterale 1 vgl. S. 83 f. und S. 86 f.



siomorphie der Pterygoten. — Die Epipleurite Basalare und Subalare (Punkt (3)) sind wohl keine Synapomorphien der Ephemeropteren und Neopteren, sondern ebenfalls (partiell) symple-siomorph; das BAS-System der Ephemeropteren (dessen vorderer Abschnitt bisher als "Basalare" bezeichnet wurde) kann dabei nur mit einem Teil der Basalaria der Neopteren, dem 2. Basalare (basII), homologisiert werden (vgl. S. 85f. und S. 88f.). — Die nach Matsuda als synapomorph zu wertende Differenzierung der "notal wing processes" (Punkt (4)) erscheint mir schwer belegbar. Da der Flügelantrieb "über einen Scutellarhebel" bei Neopteren (Hymenopteren, Dipteren) als eine späte Errungenschaft (innerhalb der Neoptera) anzusehen ist, kann zumindest dieser spezielle Antrieb als eine Konvergenz der Neoptera und Ephemeroptera betrachtet werden; er läuft bei den Ephemeropteren über das "Pt4" (= posterior notal process; Matsuda, 1970), bei Hymenopteren und Dipteren dagegen über das Pt1 und den "anterior notal process" ab. — Im Punkt (5) wird die Thoraxmuskulatur der Ephemeroptera und Neoptera als weitgehend synapomorph gewertet. Auch diese Übereinstimmungen sind wohl größtenteils Symple-siomorphien (einzelne Muskeln sind wahrscheinlich auch noch bei den Odonaten vorhanden). — Der mit starken dorsalen Längsmuskeln versehene Flügelantrieb (Punkt (6)) unterscheidet sich schließlich bei den Ephemeropteren und Neopteren grundsätzlich (zur Konvergenz der TWM-Systeme bei Ephemeropteren und Neopteren vgl. S. 85 und 88).

Eine der Grundlagen der Argumentation Matsuda's ist noch kritisch zu betrachten. Der Autor schließt aus dem Alter der "Odonata" (die dabei wohl im weiteren Sinne verstanden werden, also nicht als \*Odonata) und anderer fossiler Gruppen ("older than Palaeodictyoptera") auf eine konvergente Entwicklung aus apterygoten Vorfahren (l.c. S. 390). Fossil repräsentierte "Taxa" sind jedoch prinzipiell nur schwer als monophyletische Einheiten zu sichern; ihre Zuordnung zu den rezenten Gruppen ist meistens problematisch und umstritten (vgl. dazu die grundlegenden Gedanken von Hennig, 1969, 1982, oder Schlee, 1971). Die Folgerung Matsuda's erscheint mir daher nicht sehr gewichtig.

In Übereinstimmung mit Matsuda nehme ich an, daß die drei Pterygoten-Hauptgruppen sich früh in der Stammesgeschichte voneinander getrennt haben — im Gegensatz zu Matsuda ist

die unterschiedliche Differenzierung ihrer Flugapparate jedoch nicht auf einer Stufe anzusetzen, auf der die Flügel noch als kleine Anlagen ("rudiments") vorlagen, sondern später, als bereits eine (wenn auch nicht sehr wirkungsvolle) Flugfähigkeit vorhanden war. Größere Veränderungen geschahen wahrscheinlich erst nach der Aufspaltung der Pterygota in ihre Teilgruppen und gingen jeweils von einem ähnlichen (schon flugfähigen) Vorzustand aus. Demnach sind die drei verschiedenen Flugapparate der Pterygota — die keine eindeutigen Synapomorphien aufweisen, die ein "Stück gemeinsamer Evolution" zweier Gruppen begründen könnten — zumindest in ihrem Grundplan als autapomorph anzusehen. Gegen eine unabhängige Entwicklung der Flügel der Odonaten und Ephemeropteren+Neopteren sprechen außerdem auch die bis ins einzelne gehenden Übereinstimmungen zwischen den Ephemeropteren und Odonaten (etwa im dorsalen BAS-Bereich; vgl. S. 87f.), die Matsuda offensichtlich übersah. Die deutlichen Unterschiede zwischen den Flugapparaten sind andererseits nicht so erstaunlich, da in den drei Pterygoten-Linien drei verschiedene (alternative) Möglichkeiten von Antriebs- und Stellsystemen verwirklicht wurden.

Der Beitrag paläontologischer Forschung zu diesen Fragestellungen ist umstritten: 1) können fossile Flügel aus entsprechend weit zurückliegenden erdgeschichtlichen Perioden in der Regel nicht sicher einer der rezenten Hauptgruppen (oder ihrer Stammgruppe) zugeordnet werden — und 2) sind die für die Beurteilung des Flug-Funktionstyps wesentlichen proximalen Bereiche der Flügel nur selten erhalten. In jüngerer Zeit wurden allerdings einige Abdrücke beschrieben, die — nach den Abbildungen zu urteilen — zahlreiche Details der Gelenkregionen erkennen lassen (Kukalová-Peck, 1974, 1978, 1983; Kukalová-Peck & Richardson, 1983; Riek & Kukalová-Peck, 1984); sie verdienen besondere Beachtung, v.a. weil sie evolutionstheoretisch sehr weitgehend interpretiert wurden, wodurch der Eindruck entstand, daß die große Lücke zu den Anfängen des Insektenfluges nun endlich geschlossen werden könne. Die Flügelgelenkbereiche von *Ostrava nigra* und *Mazonopteron wolfforum* (Palaeodictyoptera der Familie Homiopteridae aus dem Ober-Karbon, von Kukalová-Peck 1983 einer monophyletischen Gruppe "Paleoptera" zugeordnet) zeigen nach der Auffassung

der Autorin die primitivsten Skleritanordnungen, die bisher bekannt sind. Sie führten zur Rekonstruktion einer aus 32 (!) Skelettelementen bestehenden ursprünglichen Gelenkregion der Pterygoten. Dieses "Ur-Flügelgelenk" wird seinerseits auf ein proximal der Subcoxa liegendes, zusätzliches Beinglied ("Epicoxa") zurückgeführt, das seinen Exiten, den späteren Flügel, ringförmig umgab (1983, l.c. Fig. 4). Nach der Zergliederung der Epicoxa in die 32 (zunächst gleichartigen, in Längs- und Querreihen angeordneten) Teile seien dann die Gelenkstrukturen der rezenten Pterygoten-Hauptlinien (Odonata+Ephemeroptera und Neoptera) durch unterschiedliche Kombination und Verschmelzung der Sklerite entstanden, wobei die Ur-Sklerite nach der Auffassung Kukulová-Peck's bis ins einzelne gehend mit den Epipleuriten, Axillaria etc. homologisierbar blieben (1983, l.c. Fig. 16). Die wenigen (und vagen) Aussagen zur Funktionsweise der Teile lassen die postulierten Entwicklungswege jedoch keineswegs "durchgängig" erscheinen. Es bleibt z.B. unklar, ob (und in welcher Ausprägung und Funktion) der Flügel seine Beweglichkeit überhaupt stets beibehielt, oder ob er nicht doch zeitweise eine Art unbewegliches "Paranotum" bildete (1983, l.c. S. 1634f.). Außerdem werden Muskulatur und Mechanik der rezenten Flugapparate zu wenig berücksichtigt. Wann und wie kamen die wesentlichen dorsalen Längsmuskeln (indirekten Senker), die das Tergum verwölben, in's Spiel? Wie erklären sich die indirekten und direkten coxalen Flugmuskeln (die "bifunktionellen" Muskeln Wilson's, 1962), die doch auf schon an der Pterygoten-Basis vorhandene, Insekten-typische Laufbeine schließen lassen und damit ein stabiles Pleurum-Widerlager erforderten? Kukulová-Peck muß (notgedrungen) bei ihren Aussagen zur Evolution der rezenten Konstruktionen sehr unbestimmt bleiben und sich auf die allerersten Anfänge der Flügelentwicklung beschränken — die große Kluft zu den rezenten Apparaten bleibt offen. Ihre Hypothese beinhaltet im Grunde die Annahme einer di-phyletischen Evolution der Flugfähigkeit (1983, l.c. S. 1638, 1645) — und ähnelt darin der Hypothese von Matsuda (1981), nur mit einer anderen Kombination der Gruppen<sup>1)</sup>. Gerade weil aber ein funktioneller Brückenschlag zu den rezenten Gruppen fehlt,

sind die vorgenommenen Sklerit-Abgrenzungen und "Homologisierungen" (1983, Fig. 16) zweifelhaft und eigentlich beliebig; sie sind — in Ermangelung wesentlicher Anhaltspunkte für die Homologisierung (z.B. der Muskulatur) — kaum zu belegen. Selbst bei den rezenten Insekten (die sich bis in winzigste Details studieren lassen) bieten die Gelenksklerite erhebliche Homologisierungs-Schwierigkeiten; eine genaue Abgrenzung ist (infolge sekundärer Abgliederungen, Zerteilungen und Verschmelzungen) oft sehr schwierig, oder vorerst noch gar nicht möglich. Die durch "Nahtlinien" angedeuteten Grenzen und Schein-Grenzen der äußeren Morphologie lassen ja keine sicheren Rückschlüsse auf die Lage von Gelenkstellen und damit auf funktionelle Bewegungseinheiten zu (das gilt natürlich insbesondere für Fossilien). Gelenke können außerdem durch eine versteckte, z.B. versenkte Lage leicht übersehen werden; v.a. aber liegen über die (für das Verständnis besonders wesentlichen) Gelenke der Flügel-Unterseite bisher keine Fossildokumentationen vor. In Anbetracht dieser Sachlage erscheint es sehr wesentlich, daß bei der Beschreibung fossiler Flügel-Gelenkregionen äußerst vorsichtig vorgegangen wird und nur die wirklich eindeutig erkennbaren Teile dokumentiert werden. Da sowohl die Bildung monophyletischer fossiler Gruppen als auch ihre Zuordnung zu rezenten Einheiten auf große Schwierigkeiten stößt, ist zudem eine begriffliche Klarheit unbedingt erforderlich (darauf geht Hennig, 1969, v.a. im Teil I, in dem er die Möglichkeiten und Grenzen der Paläontologie analysiert, ausführlich ein). Die Widerlegung der von Hennig (1969) angeführten synapomorphen Merkmale der \*Palaeoptera durch Kukulová-Peck (1983, S. 1661) scheint mir aus diesem Grund nicht fundiert zu sein, da \*-Gruppen und (echte) Stammgruppen von der Autorin nicht klar unterschieden werden (übrigens auch nicht bei Riek & Kukulová-Peck, 1984).

Verschiedene Annahmen und Folgerungen Kukulová-Peck's lassen eine vorsichtig-kritische Einstellung etwas vermissen. Zu der (anscheinend nicht in ihr Bild passenden) Tegula bemerkt die Autorin z.B. (1983, S. 1636): "The tegula is a trichobothrium, not a sclerite (E. L. Smith, personal communication)...". Nicht einmal bei den rezenten Gruppen ist jedoch eine zweifelsfreie Homologisierung der "Tegulae" möglich (vgl. S. 89)! Oder: Gleitflieger, die am Vorhandensein einer "starrten" (hinteren) Axillarplatte (= RAP) zu erkennen seien, "never

<sup>1)</sup> Auch Matsuda (1981) lehnt übrigens eine monophyletische Entstehung der Flügel (als Stummel) nicht kategorisch ab!



flap their gliding planes while gliding" (1983, S. 1665). Zeigen segelnde Aeshniden (*Aeshna grandis*, *Anax imperator*) nicht sogar das Gegenteil, nämlich alle Übergänge zum Schlagflug? Außerdem besitzen auch die sicher höchst selten segelnden, wahrscheinlich plesiomorphen (!) Zygopteren eine Radioanalplatte, die (wie bei Anisopteren) jedoch keineswegs starr ist.

Eine genauere Zuordnung und Bewertung der fossilen Flügelgelenke (von denen man sich so viel versprochen hat) wird auch in Zukunft mit großen Schwierigkeiten verbunden sein. Ihre Interpretation wird z.B. entscheidend vom Kenntnisstand der Funktionsmorphologie der rezenten Gruppen und von der Existenz einer Ausgangsbasis gesicherter Homologievorstellungen abhängen. Dies kann am Beispiel von *Ostrava nigra* noch einmal illustriert werden. Hennig vermutete (1969, l.c. S. 145; unter Bezug auf eine frühere Arbeit Kukalová's), daß das Flügelgelenk aller rezenten Pterygota "aus einem Vorzustand, wie ihn Kukalová bei *Ostrava* beschreibt, ..., hervorgegangen sein muß". Er ordnet *Ostrava* damit sogar weiter basal im System ein als Kukalová. Hennig empfindet allerdings das Fehlen der Costalplatte bei diesem Fossil als etwas verwunderlich, wobei er davon ausgeht (l.c. Abb. 25), daß die ganze Odonaten-Costalplatte (incl. der dhCP) der Humeralplatte der übrigen Pterygoten homolog ist (in der vorliegenden Arbeit wird dagegen nur die dhCP der Humeralplatte gleichgesetzt). Neuere Abbildungen von *Ostrava* (Kukalová-Peck & Richardson, 1983, Fig. 20) zeigen im vorderen Basisbereich des Flügels einen weiteren Skleriten, der in der Abb. 25 von Hennig noch fehlt. Dieser könnte (s. Kap. 3) mehrere Deutungen erfahren: Er könnte z.B. einer Humeralplatte (dhCP) entsprechen (die proximale Costalplatte, bzw. der Sklerit BAS, würde dann in einem basalen, nicht fossil erhaltenen Abschnitt liegen — sie könnte auch mehr oder weniger reduziert sein), oder der proximal davon liegenden Struktur BAS homolog sein. Der ursprünglich an der Pterygotenbasis vorhandene Hauptteil der Costalplatte (BAS) wäre also bei *Ostrava* entweder noch vorhanden oder schon teilweise bis ganz reduziert. Die Humeralplatte könnte sogar auf die Flügelunterseite gewandert sein (vgl. S. 89f.). Eine genaue Zuordnung des (in wesentlichen Bereichen nicht erhaltenen) Flügelgelenks zu einer bestimmten Gruppe (oder Stammgruppe) der Pterygota bleibt daher weiterhin problematisch.

Evolution des Flugapparates innerhalb der Odonaten und funktionelle Deutung einiger Merkmale des Flügelgeäders

Die Zygoptera und Anisozygoptera (mit der einzigen, durch zwei Arten vertretenen rezenten Gattung *Epiophlebia*) zeigen einige gemeinsame Merkmale des Flugapparates, die auf eine ähnliche Flug-Spezialisierung (d.h. einen ähnlichen Flugtyp) hinweisen. So ist der Winkel  $\lambda$  der Grundschißbahnebene des Flügels kleiner als bei den Anisoptera; er kann (beim Vorder- und Hinterflügel!) zur Vertikalen oder zur Horizontalen hin verändert, also vergrößert oder verkleinert werden. Da die Anisozygoptera + Anisoptera eine monophyletische Gruppe bilden (beide Gruppen besitzen einige abgeleitete, wahrscheinlich synapomorphe, Merkmale: Kiemenenddarm der Larven, s. Asahina, 1954; dreiarmlige abdominale Haltezange der Männchen, s. Hennig, 1969, l.c. S. 321ff.), sind diese Übereinstimmungen der Zygoptera und Anisozygoptera als Symplesiomorphien anzusehen (die Möglichkeit einer Konvergenz wird ausgeklammert, s. unten). Dafür sprechen auch Merkmale im Flugapparat der Anisoptera (welche selbst eine sichere monophyletische Gruppe darstellen — vgl. z.B. Fraser, 1957 und Pfau, 1971), die deutliche Anzeichen sekundärer Veränderung aufweisen: als Folge der Reduktion verschiedener Muskeln des Schlagbahn-Stellsystems — der pa fehlt in beiden Segmenten, der dlm wurde im Metathorax reduziert (vgl. S. 61f.) — zeigen die Flugsegmente der Anisopteren insgesamt eine stärker ausgeprägte Heteronomie. Da es unwahrscheinlich ist, daß die homonome Ausprägung des Thorax bei Zygopteren und Anisozygopteren konvergent entstanden ist, kann gefolgert werden, daß der Pterothorax des letzten gemeinsamen Vorfahren der Odonata zygopteroid-anisozygopteroid beschaffen war (vgl. dazu auch S. 82ff.).

Interessant ist, daß bestimmte Teilstrukturen des Vor-Zurückschwingsystems innerhalb der Zygoptera (deren Monophylie nicht gesichert ist; vgl. Fraser, 1957) und bei *Epiophlebia* in unterschiedlicher Ausprägung auftreten: Während im Mesothorax bei allen Gruppen zwei Tergalsklerite (vTS und hTS) vorhanden sind, fand sich im Metathorax bei den meisten untersuchten Zygopterenfamilien (Calopterygidae, Epalagidae, Chlorocyphidae, Platycnemididae, Coenagrionidae und Protoneuridae) nur ein Sklerit, der vergrößerte vTS — der hTS ist reduziert, d.h. durch Membran ersetzt. Bei den Les-



tiden und auch bei den Hemiphlebiiden<sup>1)</sup> ist der hTS dagegen auch im Metathorax noch weitgehend erhalten, was als ursprünglicher Zustand aufgefaßt werden kann. *Epiophlebia* besitzt im Metathorax ebenfalls beide Teile, gegeneinander noch beweglich, jedoch schon weitgehend anisopteroïd verschmolzen (s.S. 62). Es erscheint lohnend, den Vergleich dieser Strukturen — die zwar funktionell relativ unbedeutend erscheinen, aber auf eine monophyletische Teilgruppe der "Zygoptera" hinweisen (die einer Aufspaltung der Zygopteren, wie sie Fraser, 1957, vorschlug, widerspricht!) — auf alle Gruppen auszudehnen.

Aufgrund der mehr horizontal ausgerichteten Grundschlagbahnebene, und der Möglichkeit zur Schlagbahnveränderung bei Vorder- und Hinterflügel durch je zwei Stellmuskeln, sind die Zygopteren (und wohl auch die Anisozygopteren) auf engem Raum außerordentlich manövrierfähige Flieger, die in der Lage sind, auch den dichteren Bewuchs des Uferbereichs von Gewässern zu besiedeln (der primitive, noch sehr feindanfällige Kopulationsmechanismus ist in diesem Lebensraum anscheinend noch "tragbar"; vgl. Pfau, 1971). Die strukturellen und funktionellen Abwandlungen des Flugapparates in der Stammgruppe der Anisoptera — die Verstellung der Grundschlagbahnebene und die Einengung des Schlagbahn-Stellbereichs der Flügel — verändern diesen ursprünglichen Flugtyp wesentlich. Sie können als eine Anpassung an eine neue ökologische Zone interpretiert werden: Die rezenten Anisopteren stellen robustere, schnellere Flieger dar, die auch besser in der Lage sind, Dauer- und Streckenflüge zu vollbringen. Sie haben den Luftraum über der freien Wasseroberfläche erobert. Infolge der vertikaler stehenden Grundschlagbahnebene ihrer Flügel wird (beim Auf- und Abschlag) mehr Vortrieb erzeugt, was den besonders "reißenden" Flug erklärt. Anscheinend wurden verschiedene Muskeln (die "Rückschwing"-Muskeln pa im Mesothorax und dlm im Metathorax; vgl. S. 61f.) mit der Verstellung der Schlagbahnebene in der Stammgruppe der Anisoptera überflüssig und konnten reduziert

werden. Damit ging auch eine Vereinfachung der Flugmechanik einher, was wiederum den Flügelantrieb effizienter machte. Im Metathorax wurde zusätzlich der Flügel-Vorschwingmechanismus (und sein Muskel, der pa) reduziert. Dieses Segment wurde so im Zuge der Spezialisierung der Anisoptera zu "Vortriebsfliegern" zu einem weitgehend reinen Antriebssegment (die tergalen Mechanik konnte in diesem Zusammenhang besonders stark vereinfacht werden! Vgl. S. 62). Die Veränderung der Grundschlagbahnebene beider Flügel bedingte jedoch gleichzeitig einen Verlust an Auftrieb, der anscheinend dadurch aufgefangen werden konnte, daß die Flügelspannen — v.a. im Hinterflügel, in dem der Anateil besonders vergrößert ist — verbreitert wurden.

Man könnte erwarten, daß der pronatorisch-supinatorische Drehspielraum der Flügel bei den Anisoptera mit der Einschränkung des Schlagbahnspielraums verkleinert werden konnte. Bestimmte, gegenüber den Zygopteren abgewandelte Merkmale des Flügelgeäders deuten jedoch sogar eher auf eine erweiterte Verwindungsfähigkeit der Flügel hin; sie stehen wahrscheinlich im Zusammenhang mit der Verbreiterung der Flügel oder/und der Verstärkung des Flügelantriebs. (Da diese Geäder-Veränderungen v.a. den Aufschlagsdrehbereich betreffen, erweitern sie möglicherweise in erster Linie den Spielraum der Vortriebserzeugung; s. oben und S. 93ff.) So ist bei den Anisopteren das Flügel-dreieck (die Discoidalzelle) sekundär vergrößert, zweigeteilt und durch zusätzliche Adern stabilisiert (vgl. Fraser, 1957). Dadurch wird ein größerer distaler und kaudaler Flügelbereich an die Cubitalsektor-Basis angekoppelt, wodurch sowohl die Übertragung der aktiven Kräfte nach distal (auf die größere Flügelfläche) wie auch der passiven Kräfte nach proximal (zur Flügelbasis) gesichert oder verbessert wird. Wahrscheinlich ist außerdem die Verlagerung des Ursprungsorts der Flügeladern "IR<sub>3</sub>" und "R<sub>4+5</sub>" (Abb. 8) zur Flügelbasis hin (vgl. Fraser, 1957) in einem Zusammenhang mit der Verwindungsfähigkeit größerer (breiterer) Flügel zu sehen, da auch dadurch die von diesen Adern "getragenen" Flügelbereiche enger an den Arculus und die Cubitalsektor-Basis angeschlossen werden (vgl. auch Pfau, 1975). Dieses Merkmal tritt allerdings auch bei bestimmten Teilgruppen der Zygoptera (und bei den Anisozygoptera) auf, und zwar v.a. dort, wo breitere, weniger "gestielte" und dichtere geaderte (schwerere!) Flügel vorhanden sind. Fraser (1957) stellt diese Grup-

<sup>1)</sup> *Hemiphlebia mirabilis* Selys (die einzige rezente Hemiphlebiide) besitzt im Meso- und Metathorax außerordentlich ähnlich ausgebildete Sklerite vTS und hTS — wahrscheinlich ein sehr ursprünglicher Zustand. Für die Überlassung eines Exemplars von *Hemiphlebia* sei Herrn Dr. J. A. L. Watson an dieser Stelle herzlich gedankt.

pen in die Nähe der Anisoptera (+Anisozygoptera) und betrachtet die Zygoptera daher als uneinheitliche (paraphyletische) Gruppe. Wenn sich diese Hypothese erhärten ließe, hätte man gleichzeitig ein gewichtiges Argument dafür, daß der gestielte, schmale ("typische") Zygopterenflügel als der ursprüngliche Flügel der Odonata (\*Odonata! Vgl. Fußnote S. 76f.) anzusehen ist. Der nähere Anschluß von "IR<sub>3</sub>" und "R<sub>4+5</sub>" an den Arculus (und die dadurch erreichte Erhaltung oder Verbesserung der Verwindungsfähigkeit im Aufschlagsdrehbereich) könnte bei Zygopteren jedoch auch konvergent entstanden sein. Dafür spricht z.B., daß innerhalb verschiedener Zygopterenfamilien noch Übergänge der Aderverlegung erhalten sind. In einigen Gruppen (Epallagidae, Calopterygidae) ist die Merkmalsevolution sogar weiter vorgeschritten als bei den Anisoptera: "R<sub>4+5</sub>" entspringt dort beinahe direkt vom Arculus.

In einem funktionellen Zusammenhang mit der Pronations-Supinations-Drehmechanik des Flügels stehen sicher noch zahlreiche weitere Merkmale des Flügelgeäders. Die Stabilisierung des Costalsektors durch verstärkte Costa-Radius-Queradern ("antenodal primaries", vgl. Fraser, 1957; pan<sub>1</sub> und pan<sub>2</sub>, Abb. 3) spielt z.B. im Aufschlagsdrehbereich eine wichtige Rolle, da der Cubitalsektor ein solides Verwindungs-Widerlager benötigt. In den breiteren Flügeln der Anisoptera+Anisozygoptera (und einiger Gruppen der Zygoptera!) ist der Costalsektor durch weitere Queradern zusätzlich verstärkt. Auffallend ist dabei, daß der Arculus am Costalsektor meist in der Mitte zwischen den beiden (durch ihre besondere Dicke hervorgehobenen) "primaries" artikuliert — manchmal ist die Gelenkstelle des Arculus auch der ersten oder zweiten Hauptquerader genähert, die dann besonders verstärkt ist. Die genauere Kenntnis der Flügelmechanik ermöglicht jetzt sogar die funktionelle Interpretation einiger ganz unbedeutend erscheinender Merkmale des Odonaten-Flügelgeäders: Der schräge Verlauf des Arculus (Abb. 3 und 8) ist z.B. wohl v.a. der "Distal-Komponente" der supinatorischen Bewegung des CuS (s.S. 53) "angepaßt" — eine entgegengesetzte Schrägstellung des Arculus würde die Verwindung behindern. Die Ausrichtung der kurzen, ebenfalls besonders kräftigen (aber in den Abbildungen von Odonatenflügeln meist nicht berücksichtigten) proximalen Costa-Radius-Querader cr<sub>2</sub> (etwa senkrecht zur Achse E1, s. Abb. 3 und 7) steht dagegen in einem Zusammenhang mit dem Flügeldreh- und Verwin-

dungsmechanismus des Abschlagsdrehbereichs; auch hier würde eine andere Ausrichtung der Ader (und eine andere Lage des Gelenkpunkts c3, an dem die Ader vorn endet) die Verwindungsbewegung beeinträchtigen.

Weitere vergleichend-morphologische wie auch biomechanische Untersuchungen sind für eine bessere Beurteilung der Flügelgeäder-Merkmale notwendig. Sie könnten nicht nur unser Verständnis der Funktionsweise der Flügel der rezenten Pterygoten (und ihrer mannigfaltigen Funktionswechsel) erweitern, sondern würden gleichzeitig auch Einblicke in die Biologie der ausgestorbenen Gruppen vermitteln, von denen wir, als einzige Reste, oft nur Flügelgeäderteile kennen.

#### DIE MUSKELFUNKTIONEN IM TABELLARISCHEN VERGLEICH

Die Komplexität der thorakalen und pteralen Mechanik macht es in vielen Fällen schwer, Muskelfunktionen durch einfache Zugexperimente an den Sehnen auf Anhieb zu erkennen; die zahlreichen Irrtumsmöglichkeiten können erst bei genauer Kenntnis aller Einzelmechanismen und ihrer wechselseitigen Abhängigkeit reduziert werden. Entsprechend vielfältig ist das Bild, das sich beim Studium der Literatur ergibt. Selbst die Autoren, die sich eingehender mit dem Flugapparat der Libellen beschäftigten, Tannert (1958) und Russenberger & Russenberger (1959/60), weichen in ihren Ergebnissen zur Skelettmechanik — und in den davon ausgehenden Interpretationen der Muskelfunktion — stark voneinander ab. Neville (1960) unternahm den Versuch, die Wirkungen der Muskeln durch Beobachtung von Skelettbewegungen und durch Muskelausschaltexperimente bei vor dem Windkanal fliegenden Libellen direkt zu erkennen. Dabei ergaben sich jedoch offenbar Widersprüche, die (ohne genauere Kenntnis der Skelettmechanik) nicht aufzulösen waren. Außerdem ist es Neville wohl nicht gelungen, die Bewegungen der Skelett-Teile tatsächlich meßbar zu machen. Da seine Meßpunkte in Wirklichkeit sehr komplizierte Raumbahnen beschreiben (die Bewegungen stehen in Abhängigkeit von mehreren Kräften und können sich zusätzlich überlagern), erfordert die Erfassung der Bewegung eines Punktes (in Bezug auf eine Kraft) nicht nur perspektivische Korrekturverfahren, sondern die gleichzeitige Berücksichtigung aller anderen wirkenden Kräfte. Es ist daher nicht gerechtfertigt, daß Neville seine Ergebnisse als exakt (weil "quantitativ") von



“nur” qualitativen Befunden positiv abhebt.

In der Tabelle 1 sind die Muskel-Termini und -Funktionen verschiedener Autoren zusammengefaßt. Dabei mußten manche Funktionsbezeichnungen in den hier verwandten Begriffsgebrauch “übersetzt” werden. In den anschließend unter 1. bis 23. angefügten Bemerkungen zur Tabelle wird versucht, einige abweichende Ergebnisse zu erläutern und bis zu ihren theoretischen Voraussetzungen (die manchmal allerdings schwer ersichtlich waren) zurückzuverfolgen.

1. — Clark (1940) geht nicht näher auf die Skelettmechanik ein, so daß die Muskelfunktionen z.T. nicht erklärt sind. Die Basalarmuskeln ( $dvm_{3,4}$ ) werden den “Subalarmuskeln” ( $pm_{1-4}$ ) als antagonistische Muskeln der Flügeldrehbewegungen gegenübergestellt: bei zeitlich verschiedenem Einsatz (“alternate action”) würde entweder der vordere Teil des Flügels (Pronation) oder der hintere (Supination) gesenkt; gleichzeitige Aktion beider Muskelgruppen würde dagegen zur Senkung des ganzen Flügels führen (l.c. S. 556). Die mit diesen Angaben nur angedeutete (einfache) Flügeldrehmechanik konnte nicht bestätigt werden.

Tabelle 1

CLARK, 1940		TANNERT, 1958		RUSENBERGER und RUSENBERGER, 1959/60	
$dvm_1$	Heber		Hebermuskel (2-geteilt)	<sup>2)</sup>	$dvm$ Heber, Supinator-Promotor (bzw. Pronator-Remotor)
$dvm_3$	Senker Pronator	<sup>1)</sup>	vorderer Senkermuskel Pronator	<sup>2)</sup>	$bm1$ Senker, Pronator (-Remotor)
$pm_1$	Senker Supinator	<sup>1)</sup>	mittlerer Senkermuskel	<sup>2)</sup>	$sm1$ Senker (Supinator-Promotor)
$dvm_2$	Heber		—		—
$dvm_5$	Heber? Beinbeweger?		—		—
$dvm_4$	Senker Pronator	<sup>1)</sup>	Steuermuskel Costa Pronator, Senker	<sup>3) 7)</sup>	$bm2$
$pm_5$	Pronator		Steuerm. Ventralausläufer Pt1 (Mesothorax Anisoptera), Pronator <sup>4)</sup> Seitl. Verspannerm. d. Mesoscutum (Zygoptera) u. Metascutum (Zygoptera + Anisoptera) <sup>5)</sup>		$Tpm$ (1, 2)
$dvm_6$	Heber		Steuermuskel Lateralausläufer Pt1 Supinator	<sup>3) 4)</sup>	$axm$ Remotor (Pronator)
$dvm_7$	Heber		Steuermuskel r + m - c Heber, Supinator	<sup>2)</sup>	$sm2$ Supinator (Promotor) <sup>10)</sup>
$pm_2$	Senker Supinator	<sup>1)</sup>	hinterer Senkermuskel (etc. s. l.c. S. 411, 422)	<sup>2)</sup>	$dml$ Supinator (Promotor)
$pm_{4a}$	} (Senker) Supinator	<sup>1)</sup>	Steuermuskel Analis 1a, Pronator	<sup>6)</sup>	$dml$ Supinator (Promotor)
$pm_{4b}$			Steuermuskel Analis 1b, Supinator	<sup>6)</sup>	
$pm_3$	Senker Supinator	<sup>1)</sup>	Steuermuskel Analis 2 Senker (etc. s. l.c. S. 411, 422)	<sup>2) 7)</sup>	$sim$ Supinator (Promotor)
$dml_1$	Senker		hinterer Verspanner des Mesoscutum	<sup>8)</sup>	$dim$ Pronator-Remotor (bzw. Supinator-Promotor) <sup>9)</sup>
—			—		$sm3$ Remotor (Pronator)

<sup>1)–23)</sup> vgl. S. 112 — 117



2. — Costal- und Radioanalplatte werden von Tannert (1958) als funktionell scharf getrennte Flügelbereiche betrachtet (s. zum Beispiel l.c. S. 423). Die Flügelverwindung kann daher nach Tannert durch alle diejenigen Muskeln beeinflusst werden, welche eine Basisplatte, relativ zur anderen, auf- oder abwärts bewegen können. Tannert nimmt dies für fast alle Muskeln an, auch für die Haupt-Heber und -Senker (l.c. S. 424; für den bas1, und für den als antagonistisch angesehenen hca, wird die Verwindungsfunktion z.B. auf S. 419 näher ausgeführt). Dabei wird zwischen einer Hauptfunktion (Antrieb) und einer Nebenfunktion (Verwindung) unterschieden. Es wird jedoch nicht

näher erläutert, wie sich die zahlreichen, und zudem auf ganz verschiedene Weise (vgl. auch Anmerkung 3 und 4) den Flügel verwindenden Einflüsse distal im Flügel auswirken und gegenseitig beeinflussen.

Auch Hatch (1966) nimmt offensichtlich eine unabhängige Auf- und Abschlagsbewegung der CP relativ zur RAP (und umgekehrt) als Ursache der Pronation und Supination an (l.c. S. 709). Hatch und Tannert kommen jedoch z.T. zu entgegengesetzten Ergebnissen. Ein (distales) Senken der Costa durch den bas1 ergibt bei Tannert eine pronatorische Drehung, welcher der hca (durch Heben der Costa) entgegenarbeiten könne (l.c. S. 410, 419); bei Hatch sind diese Mus-

EVILLE, 1960	HATCH, 1966		PFAU, 1986	
tergosternal Heber, Pronator <sup>15)</sup>	dvm1	Heber	dvm1	Aufschlagsm. (Antrieb) (Rückschwungm.)
cond basalar Heber, Pronator <sup>15) 16) 18)</sup>	dvm3	Senker, Pronator	<sup>20) 22)</sup> bas 1	Abschlagsm. (Antrieb)
subalar Heber	pm1	Senker	<sup>20)</sup> sub1	Abschlagsm. (Antrieb), Supinator
	dvm2		<sup>21)</sup> dvm2	Einstellm. (Abschlag)
	dvm5		<sup>21)</sup> (tc; s. Fußnote S. 45)	
basalar Heber, Pronator <sup>15) 16) 18)</sup>	dvm4	Pronator	<sup>20) 21)</sup> bas2	Einstellm. (Aufschlag)
	pm5	Promotor (?)	tp	Einstellm. ("Klickmech.")
anterior coxoalar Heber, Remotor, Heber <sup>17)</sup>	dvm6	Heber, Supinator	<sup>20)</sup> vca	Supinator der unteren Schlagwende (Heber)
posterior coxoalar Heber (l.c. S. 639)	dvm7	Heber, Pronator	<sup>20)</sup> hca	Pronator der oberen Schlagwende (Heber)
cond subalar Heber, Supinator <sup>15) 18)</sup>	pm2	Senker, Supinator	<sup>20) 22)</sup> sub2	Supinator (Abschlag), Senker
	pm4 a,b	(Funktion s.b. Tannert)	fa	Pronator (Aufschlag)
cond subalar Heber, Supinator <sup>15) 19)</sup>	pm3	Supinator	<sup>20) 21)</sup> sub3	Supinator + Einstellm. (Aufschlag)
	d1m1	Promotor (?)	<sup>23)</sup> d1m	Vorschwingm. (Mesothorax) Rückschwungm. (Metathorax)
	—		pa	Rückschwungm. (Mesothorax) Vorschwingm. (Metathorax)

keln dagegen (bezüglich der Flügeldrehung) Synergisten (zu Hatch vgl. auch Anm. 20—23).

3. — Tannert's Bewegungsanalysen sind anscheinend durchweg auf mazeriertes Tiermaterial gegründet. Beim Mazerieren wird das Resilin aus den Gelenkverbindungen (wie z.B. dem Pleuralgelenk p1) herausgelöst; diese zeigen anschließend einen viel weiteren Bewegungs-(Membran-)Spielraum als beim lebenden oder frischtoten Tier. Das Pleuralgelenk p1 ("Unterstützungsgelenk der proximalen Cp" bei Tannert) wurde sicher aus diesem Grund als "Schlittengelenk" verkannt (l.c. S. 404, 418, 420; Abb. 12, 13). Damit wohl zusammenhängend ist nach Tannert die gesamte CP (bei Tannert: proximale Cp+distale Cp; hier, etwas verändert: vCP+mCP+phCP+dhCP, vgl. S. 41) um eine Achse drehbar, die vom "vorderen Scuto-Alargelenk" (t1) durch das vordere Pleuralgelenk (p1) zum "Bereich des distalen Verwindungsgelenks" (bei c3) läuft (l.c. Abb. 5, 18, 36; der distale "Angelpunkt" dieser Achse wird dabei offensichtlich vom Gelenk c3 unterschieden — l.c. S. 418, 423, 432 — ein zweites Gelenk konnte von mir jedoch an dieser Stelle nicht aufgefunden werden). Diese Verwindungsachse existiert jedoch in Wirklichkeit nicht; eine Drehung der gesamten Costalplatte (relativ zur RAP+"c-RAP-Brücke", l.c. S. 418) kann nicht stattfinden (zur Achsen-Anordnung und -Funktion vgl. auch Abb. 7 und S. 47ff.). Der bas2 ist damit kein Drehmuskel der CP (Pronator); bas2 und vca (die sich bei Tannert — an einem zwei-armigen Hebel angreifend — zu beiden Seiten der "Verwindungsachse" gegenüberstehen) sind außerdem nicht als Antagonisten zu betrachten (vgl. auch Anm. 4).

4. — Nach Tannert ist der vordere Tergalsklerit vTS (den er, zusammen mit dem Randsklerit, als "Pterale 1" bezeichnet — zur Homologisierung des Pterale 1 vgl. jedoch S. 83f.) um eine in Tierlängsrichtung verlaufende Drehachse schwenkbar (l.c. Abb. 14b). Der Tergopleuralmuskel tp ("Steuerm. Ventralausläufer Pt1") soll nun durch Anhebung des Randsklerits (RS — bei Tannert "Lateral ausläufer Pt1") indirekt (durch Schub von ventral her auf die CP) eine pronatorische Drehung der gesamten CP (vgl. Anm. 3) bewirken; der Muskel ist bei Tannert somit ein Antagonist des vca und ein Synergist des bas2. Eine Bewegung des vTS durch den tp nach lateral-ventral (zur Anhebung des Randsklerits; vgl. l.c. Abb. 14b) ist jedoch nicht möglich. Der RS ist außerdem als ein-armiger, am vTS gelenkig ansitzender Hebel zu betrachten, über den bei Kontraktion des vca — durch Zug an der hinteren Costalplatte hCP — eine Supination erreicht wird; der tp wird dabei nicht gedehnt. Vorderer Tergalsklerit und Randsklerit bilden demnach keinen zwei-armigen Hebel, wie Tannert annimmt. Eine Schubwirkung des wenig harten (biegbaren) RS kann — auch aufgrund der Zwischenmembran zur phCP — ausgeschlossen werden.

5. — Die genaue Muskelwirkung wurde nicht erläutert (zu der nach Tannert abweichenden Funktion des mesothorakalen tp der Anisoptera s. Anm. 4). Nach der vorliegenden Arbeit haben die tp-Muskeln im Meso- und Metathorax (bei Zygoteren und Anisozygoteren+Anisopteren) die gleiche Funktion (s. S. 45f.).

6. — Die beiden Muskeln arbeiten nach Tannert antagonistisch und heben bzw. senken das "Analfeld" (l.c. Abb. 28). Die "Verwindungsachse" würde dabei proximal durch die Mitte des Ansatzgebietes der beiden Muskeln, distal mitten durch den Arculus verlaufen (l.c. Abb. 5, 36). Diese Ausrichtung der Drehachse und die antagonistische Funktion zweier Muskelteile des fa (von den beiden Seiten eines zwei-armigen Hebels aus) konnte nicht bestätigt werden (vgl. S. 53ff.); das "Analfeld" Tannert's entspricht daher auch nicht dem Cubitalsektor. Eine Zweiteilung des fa wird (wie im Falle des dvm1, vgl. Fußnote S. 60) durch die ein-tretende Trachee, und eine dafür vorhandene Einbuchtung im Apodem, vorgetäuscht.

7. — Tannert nimmt anscheinend eine "Steuerung" der großen Hauptmuskeln durch die kleinen (als synergistisch interpretierten) Nebenmuskeln an (l.c. S. 424f.) — sowohl bezüglich der Schlagfunktion als auch der (für fast alle Muskeln postulierten) Verwindungsfunktion (s. Anm. 2). Vor allem für die Paare bas1—bas2 und sub2—sub3 wird dies genauer erklärt (s. z.B. l.c. S. 411). Nach der hier dargestellten Auffassung (S. 45) "steuern" die kleinen, tonisch aktiven Muskeln dagegen die Kraftwirkung des jeweils antagonistischen Hauptmuskels (der bas2 also z.B. den dvm1; für den sub3 vgl. S. 56).

8. — Der Muskel wird bei Tannert nur auf S. 409 (für den Mesothorax) ohne nähere Erklärung seiner Funktion erwähnt.

9. — Russenberger & Russenberger (1959/60) nehmen eine kombinierte Flügel-Pronation und -Remotion durch die Muskeln sm3, axm und dim beim Abschlag an; entgegengesetzt (supinierend und vorziehend) wirken beim Aufschlag der dvm (s. aber weiter unten) und auch der dim (zur indirekten Wirkung des dim s. auch Anm. 13). Diesen Flügelbewegungen wird eine komplizierte Mechanik (u.a. Kippung des Tergum "in der Medianebene", d.h. um eine Querachse, und Annäherung der pleuralen "Schwingenpfeiler") zugrundegelegt (l.c. Abb. 31a,c). Fast alle Muskeln (auch die direkten Antriebs-Senker) spielen, dieser Mechanik zufolge, eine Rolle als Pronatoren-Remotoren bzw. Supinatoren-Promotoren (einige Funktionen wurden in der Tabelle — der von Russenberger & Russenberger postulierten Mechanik entsprechend — in Klammern ergänzt). Die beiden Autoren betrachten den dvm (ähnlich wie Tannert) als 2-köpfigen Doppelmuskel, wobei sie im dorsalen An-

satzapodem ein Quergelenk (zwischen den beiden Muskelteilen) annehmen (vgl. l.c. S. 23f., 48). Bei Kontraktion würde der dvm entweder Pronation-Remotion oder Supination-Promotion bewirken, je nachdem welcher Teil des Muskels stärker arbeitet. Die in Abb. 31a, c bei Russenberger & Russenberger dargelegte Mechanik konnte nicht bestätigt werden (zur Zweiteilung des dvm vgl. Fußnote S. 60).

10. — Russenberger & Russenberger diskutieren für diese Muskeln, die nach ihrer Ansicht kaum als Senker von Bedeutung sein können, die Möglichkeit einer "Rücksteuerung" des Thorax-Resonanzsystems (vgl. l.c. S. 80ff.).

11. — Die Autoren erwägen eine rechts-linksseitig unterschiedliche Kontraktion dieser Muskeln und nehmen (sehr allgemein) eine Beeinflussung der "Stellung der einzelnen, am Flugmechanismus beteiligten Sklerite" (l.c. S. 28) an. Sie diskutieren auch die Möglichkeit einer gegenläufigen Bewegung des rechten und linken Flügels, u.a. bewirkt durch die Tpm (l.c. S. 47 und Abb. 31b; eine ähnliche Funktion der Tpm = pm5 nimmt auch Hatch, l.c. S. 713, an). Der dafür als Beweis angesehene Hochschulfilm von v. Holst, 1950, zeigt diese Gegenläufigkeit jedoch nicht (vgl. dazu S. 43f. und S. 45f.). Obwohl Russenberger & Russenberger auf die doppelfrequente Bewegung der Pleuren hinweisen (l.c. S. 46f.), erkannten sie die Bedeutung der Tpm für die Einstellung eines bistabilen Flügelschlagmechanismus anscheinend nicht.

12. — Russenberger & Russenberger untersuchten offensichtlich die Muskulatur subadulter (aus Larven gezogener) Exemplare von *Aeshna cyanea* (l.c. Abb. 18). Darauf weisen die Muskelproportionen und auch der (im adulten Tier reduzierte) Muskel sm3 (s. auch Anm. 14) hin. Einige Fehleinschätzungen sind wohl darauf zurückzuführen: der sm3 wird anscheinend mit dem Illism, von Clark (1940) verwechselt (einem zum Abdomenrand führenden, intersegmentalen Muskel, der entgegen Clark's Annahme ohne Bedeutung für den Flügelschlag ist), den die beiden Autoren nun auch im Mesothorax aufzufinden meinen; vca und hca (=axm) werden nicht unterschieden (s. l.c. S. 28), der Ursprungsort außerdem nicht richtig beschrieben (Verwechslung mit anderen Muskeln?); der von Russenberger & Russenberger als dlm bezeichnete Muskel (fa der vorliegenden Arbeit) wird im Metathorax anscheinend mit dem (dort bei juvenilen Tieren noch größeren) dim vermergt und als ein Muskel betrachtet; etc.

13. — Russenberger & Russenberger beschreiben eine (auf dem Schlagphasen-Unterschied zwischen Vorder- und Hinterflügel beruhende) unterschiedliche, d.h. pronatorische (beim Abschlag) oder supinatorische (beim Aufschlag) Drehwirkung dieses Muskels in den beiden Schlagphasen (l.c. S. 77f.; s. dazu auch Anm. 9). Sie nehmen außerdem an, daß der Muskel dim die "Phasenverschiebung zwischen Vorder-

und Hinterflügel" beeinflusst (l.c. S. 26, 49: "Koppelmuskel zwischen den Flügelsegmenten"). Die segmentkoppelnde Kraft der dim ist jedoch infolge der starken Spreizung der Muskeln nach kaudal wahrscheinlich sehr gering (vgl. S. 61).

14. — Dieser Muskel, von Russenberger & Russenberger als "3. Subalarmmuskel" bezeichnet, ist wohl mit dem Pleuroalarmmuskel pa (dem Muskel Nr. 31 bei Asahina, 1954 — im Metathorax Nr. 53) identisch. Er läuft bei Zygopteren (und bei der Gattung *Epiophlebia*) vom kaudalen Innenrand der RAP (oder der Membran medial davon) nach vorn-seitlich-unten an die Pleuralleiste (Abb. 2). Bei adulten Anisopteren ist der Muskel reduziert (nur eine Sehneinstülpung zeigt noch seine dorsale Ansatzstelle) — bei subadulten kann er dagegen in beiden Segmenten noch mehr oder weniger gut entwickelt aufgefunden werden (vgl. dazu Anm. 12). Asahina (1954) beschreibt den Muskel auch für *Davidius* (möglicherweise untersuchte er ein subadultes Exemplar); ich konnte ihn jedoch bei anderen (adulten) Gomphiden (*Ictinogomphus*, *Onychogomphus*, *Gomphus*) nicht mehr auffinden.

15. — Zur Erklärung der Drehwirkung der Flügel-senker und -heber bezieht sich Neville (1960, S. 631, 653) auf eine Hypothese von Weis-Fogh (1956). Danach stehen sich bei *Schistocerca* im Mesothorax vor und hinter dem Fulcrum Antriebsmuskeln gegenüber (die Basalar- und Subalarmmuskeln), die als Antagonisten (durch verschieden starken Einsatz oder unterschiedlichen Kontraktionszeitpunkt — s. auch Anm. 1 zu Clark, 1940) die Flügelanstellung, durch Drehung des Flügels um das Fulcrum, bestimmen sollen. Der sub1 wird von Neville dementsprechend — aufgrund seiner angenommenen "neutralen Lage" zwischen den vor dem Fulcrum befindlichen Basalarmuskeln (die als Pronatoren angesehen werden) und den dahinter liegenden Subalarmmuskeln sub2 und sub3 (welche den Flügel supinieren) — als reiner Abschlagsmuskel betrachtet (l.c. S. 649). Nach der in der vorliegenden Arbeit beschriebenen Verwindungsmechanik trifft das jedoch nicht zu (vgl. S. 47ff.). Auch bei Heuschrecken hat sich gezeigt, daß der Flügel nicht einfach als Ganzes um das Fulcrum drehbar ist (— diese Bewegung würde mit dem Auf-Abschlagsmechanismus des TWM in Konflikt geraten), sondern daß eine die Antriebsmechanik "umgehende", flügelinterne Verwindungsmechanik vorliegt (vgl. Pfauf, 1977b, 1978a; s. dazu auch S. 91, 92).

16. — Unglücklicherweise wird der 1. Basalarmmuskel (first basalar bzw. dvm<sub>1</sub> bei Clark) von Neville als "second basalar", der 2. Basalarmmuskel (second basalar Clark's oder dvm<sub>2</sub>) dagegen als "first basalar" bezeichnet. Beide Basalarmmuskeln werden als phasische Muskeln betrachtet, die schon am Ende des Aufschlags (l.c. S. 649; evtl. sehr frühzeitig, s. Fig. 19f — vgl. aber Anm. 18) eingesetzt werden können. Zum Nachweis ihrer pronatorischen Wirkung (die in der vorliegenden Arbeit nicht bestätigt werden kann; vgl.



S. 50) durchtrennte Neville beide Basalarmuskeln und beobachtete die Flügelanstellung bei vor dem Windkanal fliegenden Tieren. Da die Flügelschlagfrequenz nach Ausschaltung um etwa ein Drittel zurückging, ist die beobachtete veränderte Flügelanstellung (i.c. Fig. 19e) jedoch für eine Pronationsfunktion der Basalarmuskeln nicht unbedingt beweiskräftig: mit einer geringeren Flügelgeschwindigkeit wird ja gleichzeitig die passive Pronation verringert bzw. ist auch eine Zunahme der supinierenden Wirkung der Muskeln sub1 und sub2 zu erwarten (ganz abgesehen von der Möglichkeit, daß die Libelle bei Kappung von Muskeln den Einsatz anderer Muskeln zum Ausgleich verändert hat).

17. — Der Muskel kann nach Neville seine Supinations-Wirkung schon vor dem Abschlagsende (i.c. Fig. 13 und v.a. Fig. 21) und dann auch in der 1. Hälfte und fast ganzen 2. Hälfte der Aufschlagsphase (i.c. S. 643, 653, 655) entfalten. (Neville's Fig. 9 und 13 stimmen jedoch damit und untereinander nicht ganz überein.) Bei der Erklärung der vermuteten zusätzlichen Funktion des vca als Remotor (i.c. S. 653) treten Widersprüche auf: wenn eine Flügel-Vorbewegung (nach Neville durch den vca, gegen Ende des Abschlags) mit einem abrupten Auseinanderweichen von RAP und CP einhergeht (i.c. Fig. 11d, 14, 15; S. 640f.; vgl. dazu aber S. 99f. der vorliegenden Arbeit), dann kann der vca kurz danach, an der Schlagwende, nicht auf einmal die entgegengesetzte Bewegung verursachen und zu einem Remotormuskel werden. Das erneute Schließen des Spaltes zwischen den beiden Flügelbasisplatten (i.c. Fig. 11e) wird von Neville anscheinend damit erklärt, daß der vca, nach einer nur anfänglich starken Kontraktion, sich (plötzlich) nur noch schwach weiter kontrahiert (i.c. S. 655) und dadurch (und durch seine Aufschlagsfunktion? s. unten) eine Flügel-Remotion bewirkt.

Neville nimmt außerdem eine "automatische" Rückziehung der Aufschlagsmuskeln, und eine entsprechende, passive Vorziehung der Abschlagsmuskeln, an (i.c. S. 652f., 641), wobei er jedoch nicht zwischen der Schlagbewegung in der (festliegenden) Grundschlagbahnebene und der (davon weitgehend unabhängig möglichen) Vor-Zurückschwing-Bewegung unterscheidet. Zur Erklärung einiger Phänomene mußte Neville dann zu komplizierten Zusatzhypothesen greifen (i.c. S. 652f.).

Der Autor beobachtete eine Diskrepanz zwischen natürlichen und manipulierten Flügelschlägen (i.c. S. 641f., 653) und zog diese z.T. zur Erklärung der vca-Funktion heran. Die beobachteten Unterschiede können jedoch anders gedeutet werden. Sie beruhen wohl darauf, daß Neville den Vorderflügel bei seiner künstlichen Imitierung des Schlags supiniert angestellt abwärts bewegte: der supiniert angestellte Vorderflügel schwingt am Abschlagsende (ausweichend) nach vorn (und "supiniert" dabei weiter, vgl. S. 59) und dann am Beginn des Aufschlags sofort wieder zurück, wobei sich RAP und CP abrupt nähern (entsprechend

Neville's Fig. 14, 15). Dieses Vor- und Zurück-schwingen ist jedoch keinesfalls die zwangsläufige Folge der geneigten Flügelschlagbahnebene (i.c. S. 641), sondern ergibt sich (zufällig) aus der unnatürlichen Flügelmanipulation und der (nur am Abschlagsende und Aufschlagsbeginn vorhandenen) Flügelbeweglichkeit nach vorn und zurück. Daß sich der Randsklerit (der Ansatzzipfel des vca, bei Neville "anterior lobe of the lateroprescutum") bei einem manipulierten Flügelschlag im Unterschied zum natürlichen Schlag nicht abrupt nach ventral bewegt, ist andererseits nicht verwunderlich.

18. — Der sub2 kann nach Neville supinierend in die Auf-Abschlagswende eingreifen (i.c. Fig. 19f.; S. 649) und dabei, und dann v.a. beim Abschlag (Fig. 19e), die pronierende Wirkung der Basalarmuskeln kontrollieren. Der Autor übersah jedoch andere pronierende Kräfte (die pronierende Wirkung des hca; die beim Abschlag passiv-pronierende Luft); die Pronationsfunktion der Basalarmuskeln trifft nach der vorliegenden Arbeit andererseits nicht zu. Die von Neville aus den Experimenten abgeleitete antagonistische Beziehung bas1,2—sub2,3 kann somit nicht bestätigt werden. Ein früher Einsatz der Muskeln sub2 und bas1 ("second basalar" bei Neville) an der Auf-Abschlagswende ist zwar wahrscheinlich möglich, wurde jedoch durch das Ausschaltexperiment (i.c. Fig. 19f) nicht erwiesen (zur Beweiskraft der Basalarmuskel-Durchtrennungen für die von Neville postulierte pronatorische Funktion der Muskeln vgl. Anm. 16).

Der 2. Subalarmuskel wird in der vorliegenden Arbeit als der wesentliche Gegenspieler der passiv-pronierenden Luft in der Abschlagsphase betrachtet (s.S. 50f., 93ff.), der bas1 ist dagegen als reiner Senker anzusehen (s.S. 50).

19. — Nach Weis-Fogh (unpubliziert, s. Neville, i.c. S. 648) ist dieser Muskel tonisch aktiv (vgl. dazu auch S. 44). Neville beschreibt mehrere Funktionen: 1) eine (kombinierte) Abschlags- und Supinationsfunktion innerhalb der Abschlagsphase (i.c. S. 648, 654) sowie 2) eine Supinationsfunktion (zeitlich nach der Supination durch den vca) in der zweiten Hälfte der Aufschlagsphase (s. i.c. Fig. 19 und S. 647, 655). Bedenkt man jedoch die hier dargelegte zugfederähnliche Wirkung tonischer, mit der Antriebsmechanik in Beziehung stehender Muskeln, so wird der sub3 beim Abschlag entlastet und ist somit in dieser Phase "ausgeschaltet" (vgl. S. 56).

20. — Den Text erklärende Funktionsskizzen fehlen leider. Aus der Beschreibung (v.a. i.c. S. 709, 713) geht hervor, daß Hatch (1966) das Zustandekommen der Pronations-Supinations-Bewegungen auf verschiedene Weise erklärt: a) Durch proximales Heben bzw. Senken der CP und RAP, die (voneinander unabhängig) um ihre pleuralen Auflagepunkte schwenken und den distal der Gelenkpunkte liegenden, dazugehörigen Flügelteil entweder senken oder

heben. Senkt sich z.B. die CP proximal, wird der Flügel supiniert, senkt sich die RAP proximal, dann wird er proniert. Diese Mechanik erinnert an Tannert (s. Anm. 2). b) Durch Kippung des Tergum um eine Querachse: senkt sich das Tergum-Vorderende, wirkt dies nach Hatch auf die CP und ergibt (s. a)) eine Supination; senkt sich das Hinterende, wirkt dies auf die RAP und hat (s. a)) eine Pronation des Flügels zur Folge. Diese Annahme einer tergalen Beweglichkeit um eine Querachse erinnert an Russenberger & Russenberger, führt aber zu gerade entgegengesetzten Flügeldrehungen (vgl. auch Anm. 9, sowie Abb. 31c bei Russenberger & Russenberger). c) Durch pronatorische oder supinatorische Drehungen der RAP, die proximal mit entsprechenden Verkippungen des Tergum (etc. s. b) und a)) einhergehen.

Die pronatorische Wirkung des *dvm7* (*hca*) wird nach Hatch anscheinend auf zweierlei Weise erreicht: durch (distales) Heben und durch Supinieren (!) der RAP (l.c. S. 713); die letztere Bewegung verstellt dann wohl das Tergum so, daß die CP proximal angehoben wird, was nach a) ebenfalls eine Pronation ergibt (? — oder es handelt sich hier um einen Druckfehler, s. auch weiter unten). Da der *dvm7* die RAP jedoch eindeutig pronatorisch dreht, kann Hatch's Mechanik schon aus diesem Grund nicht zutreffen. Auch der bei Hatch beschriebene Supinations-Mechanismus des *dvm6* (*vca*) — durch distales Heben der CP (s. a)) — kann in Wirklichkeit nicht stattfinden: da CP und RAP über zwei distal der Schlagachse liegende Gelenkpunkte miteinander verbunden sind (vgl. S. 50), würde durch ein distales Anheben der CP der ganze Flügel nur aufgeschlagen.

Ausgehend von der postulierten CP-RAP-Unabhängigkeit, nach der Unterschiede in der normalen Schlagbewegung der beiden Basisteile zu Änderungen der Flügelanstellung führen, betrachtet Hatch die vorderen direkten Senker (*dvm3* und *dvm4*) als Pronatoren, die hinteren (*pm2* und *pm3*) als Supinatoren (die letzteren sollen jedoch auch die RAP supinieren können, was im Widerspruch zum oben beschriebenen *dvm7*-Mechanismus steht). Der *pm1* (l.c. Fig 6A) wird in dieser Hinsicht als neutral betrachtet (was aber anderen Aussagen widerspricht; s. a)).

21. — Für die als tonisch eingeschätzten Muskeln *dvm2*, *dvm4*, *dvm5* (?) und *pm3* nimmt Hatch an, daß sie den Flügel beim Gleitflug in ihrer Stellung (und z.T. auch in der Anstellung) stabilisieren. Sie sollen außerdem für die Flügel-Ruhehaltung bedeutsam sein.

22. — Der *pm2* steht dem *dvm3* nach Hatch beim Abschlag antagonistisch gegenüber (vgl. dazu auch Anm. 18 zu Neville).

23. — Hatch nimmt außerdem an, daß die (ebenfalls als tonisch eingeschätzten) mesothorakalen *dm1* die Vorder- und Hinterflügel beim Flug voneinander entfernt halten.

## DANKSAGUNG

Die Untersuchungen wurden durch die Deutsche Forschungsgemeinschaft finanziert (Ri 57/18, Ri 57/20-3 und Pf 174/1-1). Für ihre Ermöglichung und geduldige Förderung danke ich Herrn Prof. Dr. H. Risler herzlich, für wertvolle Diskussionen und Durchsicht des Manuskripts v.a. Herrn Prof. Dr. D. Bilo (Saarbrücken) und Frau Dr. B. Schroeter. Zu besonderem Dank bin ich außerdem Herrn Dr. S. Asahina (der mir fixierte Exemplare der außergewöhnlichen Libelle *Epiophlebia superstes* überließ), Herrn Prof. Dr. G. Rüppell (der mir eine Kopie seines hervorragenden Filmes über das Flugverhalten von *Aeshna cyanea* zur Auswertung zusandte) und Frau K. Rehbinder (die verschiedene Abbildungen überaus sorgfältig "ins Reine" zeichnete) verpflichtet.

## ZUSAMMENFASSUNG

Der Libellenflügel wird beim Schlag in einem (durch zwei pleurale Gelenklager gebildeten) Scharniergelenk bewegt — dadurch ist eine Grund-Schlagbahnebene festgelegt. Drei starke Muskeln treiben den Flügel an, die direkten Senker *bas1* und *sub1* und der indirekte Heber *dvm1*. Schwächere, tonische Muskeln (*dvm2*; *bas2*, *sub3*) können entweder den Abschlags- oder den Aufschlagsmuskeln entgegenwirken, so daß der "Flugmotor" in beiden Schlagphasen (auch unilateral) "gedrosselt" werden kann. Der Muskel *tp* vermag eine elastische, bistabile Komponente des Flügelschlags — durch Veränderung der Rückstellkraft der Pleuralleiste, die in beiden Schlagphasen zunächst nach lateral ausgelenkt wird — einzustellen.

Die Drehungen des Flügels um die Längsachse (Pronation, Supination) laufen in zwei mechanisch unterschiedlichen Drehbereichen, die den beiden Schlagphasen zugeordnet werden können, ab. Bei einer Pronation im Abschlagsdrehbereich wird der "Verstellflügel" sowohl als Ganzes (in zwei proximalen Scharniergelenken) proniert als auch gleichzeitig unter Spannung gesetzt und pronatorisch verwunden; die Verwindung wird dabei durch die Schubbewegung eines vorderen Flügelteils (Costalsektor) gegen den dahinter liegenden Hauptteil der Flügelspreite (Cubitalsektor) bewirkt. Bei einer Supination im Aufschlagsdrehbereich bewegt sich dagegen der Cubitalsektor gegen den Co-



stalsektor. Der Flügel wird dadurch ebenfalls verwunden. Diese Verwindung ist jedoch (im Gegensatz zur pronatorischen Verwindung im Abschlagsdrehbereich) eine "reine" Flügelverwindung — sie geht mit keiner Drehung des ganzen Verstellflügels einher. Die beiden Drehbereiche grenzen in einer mittleren Anstellung (0°) aneinander; sie sind dort durch mechanische Anschläge (die ein "Überlappen" verhindern) voneinander getrennt. Die verschiedenen pronatorischen bzw. supinatorischen Stellmuskeln sind somit entweder dem einen oder dem anderen Drehbereich zuzuordnen. Einzelne dieser Muskeln können als Muskeln der Schlagwendepunktsdrehungen angesehen werden (hca; vca), andere als Einstellmuskeln der Flügelanstellung. Unter den letzteren vergrößern bestimmte Muskeln den aerodynamischen Anstellwinkel und arbeiten dabei gegen die anströmende Luft (sub1 und v.a. sub2 beim Abschlag, fa beim Aufschlag); nur ein Muskel, der sub3, vermag den Anstellwinkel zu verkleinern und verringert gleichzeitig die Aufschlagsgeschwindigkeit.

Die Kontraktion der mesothorakalen dorsalen Längsmuskeln (dlm) bewirkt eine Schubbewegung des Tergum nach kaudal-dorsal und führt — in einem flügelinternen, aus zwei Gelenken zusammengesetzten Scharniergelenk — zu einem Vor-Schwingen des Flügels (Änderung der Schlagbahn). Dieser Bewegungsablauf kann jedoch erst gegen Ende des Abschlags, und nach Erreichen des 0°-Anschlags des Abschlagsdrehbereichs, stattfinden. Der dvm1 (der Heber des Flügelantriebs) schwingt den Flügel zu Beginn des Aufschlags (automatisch) wieder zurück. Die bei Zygoteren und Anisozygoteren (*Epiophlebia*) gegenüber den Anisopteren (v.a. im Metathorax) abweichenden Verhältnisse des "Vor-Zurückschwing-Systems" werden beschrieben und diskutiert.

Die dargelegten Ergebnisse zur Skelettmechanik unterscheiden sich von älteren Befunden in wesentlichen Punkten und führen dementsprechend zu neuen Interpretationen der Flug- und Stellmuskel-Funktionen. Die Hypothesen der verschiedenen Autoren werden verglichen.

Bestimmte Mechanorezeptoren in der Flügelbasis — ein Chordotonalorgan (CH) und zwei Reihen von campaniformen Sensillen (CF1, CF2) — werden durch die Verwindungsbewegungen des Flügels beansprucht: das CH wird sowohl bei pronatorischer als auch supinatori-

scher Verwindung über kleine Hebelelemente der Flügelunterseite entdehnt (gedehnt wird der Rezeptor jeweils bei den Rückdrehungen zur 0°-Anstellung hin); in der Kutikula der Felder campaniformer Sensillen treten bei den Flügelverwindungen Zugspannungen (quer zum Flügel) auf. Elektrophysiologische Ableitungen (bei Drehung des Flügels um die Längsachse) ergeben, daß die Sensillen des CH stark phasisch sind und Flügeldrehungen in beiden Drehbereichen (und dort in beiden Richtungen) anzeigen. Die campaniformen Sensillen, die ein phasisch-tonisches Zeitverhalten aufweisen, werden dagegen nur bei Drehbewegungen zu den Anstellextremen hin erregt — CF1 anscheinend bei Pronation, CF2 bei Supination. Diese Rezeptoren könnten zur Messung der geometrischen Flügelanstellung und (indirekt — über den jeweiligen Spannungszustand in der Kutikula und dessen zeitliche Änderung) zur Registrierung der die Flügelanstellung verändernden Luft- und Muskelkräfte eingesetzt werden.

Der Vergleich der Flugapparate der Odonaten, Ephemeropteren und Neopteren führt zu neuen Homologievorstellungen und zur Rekonstruktion eines "Ur-Flugapparates" der Pterygoten (mit zwei Schlagachsen); die rezenten Flugapparate können davon ausgehend in drei alternativen Linien abgeleitet werden. Damit kann der Hypothese einer polyphyletischen Entstehung der Pterygota widersprochen werden — das Problem der Aufspaltung der Pterygota bleibt jedoch ungeklärt. Evolutive Veränderungen innerhalb der Odonaten betreffen v.a. die Ausrichtung der Grundschlagbahnebene und das Vor-Zurückschwing-System (das nur bei Zygoteren und Anisozygoteren in beiden Pterothorax-Segmenten entwickelt ist); die Anisoptera werden als sekundär vereinfachte "Vortriebsflieger" angesehen.

#### SUMMARY

During the wing stroke the dragonfly wing moves up and down on a hinge joint formed by two pleurum-to-wing articulations, which determines the stroke plane angle of the wing. The wing is driven by strong direct depressor muscles (bas1, sub1) and indirect levators (dvm1), which provide motor power for flight. Certain tonic muscles, which are comparatively weak (dvm2, bas2, sub3), are able to counteract either the downstroke (dvm2) or the upstroke (bas2, sub3) power muscles; thus the flight motor can be throttled back in both stroke phases. A ter-



gopleural muscle (tp) is able to vary the recoil of the pleural ridge, which is bent outwards and loaded in the first part of both the downstroke and the upstroke, and swings back inwards (and is unloaded) in the second part. In this way a bistable mechanism, superimposed on each wingstroke phase, is adjustable by the muscle tp.

The mechanics of the wing movements along its long axis (pronation, supination) are different in two ranges of rotation ("Abschlagsdrehbereich", "Aufschlagsdrehbereich"), which presumably correspond to the ranges of geometrical angle of attack used within the two stroke phases. During pronation in the "Abschlagsdrehbereich" a major part of the wing ("Verstellflügel") is pronated as a whole. Since this movement is determined by two proximal hinge joints, the wing is additionally put under pressure and also pronated by twisting; the twisting is caused by the pressure of the frontal sector of the wing ("Costalsektor") against the caudal sector ("Cubitalsektor"). During supination in the "Aufschlagsdrehbereich" it is the cubital sector, which is pressed against the costal sector; this again causes a twisting (supination-twisting in this case), but is not associated with a movement of the "Verstellflügel" as in the "Abschlagsdrehbereich". The two different ranges of rotation border on each other at 0°, the mean geometrical angle of attack, at which the wing is not twisted. Mechanical stops prevent overlapping of the ranges of rotation. Therefore the muscles of pronation and supination can be assigned to either the "Abschlagsdrehbereich" or the "Aufschlagsdrehbereich".

Different types of pronator and supinator muscles are described: (a) muscles that rotate the wing at the turning-points of the stroke (upper turning-point: hca; lower one: vca) and (b) muscles that are able to adjust the angle of attack mainly within the upstroke or downstroke phase. Among these latter muscles some exert force against the airflow (rotating the wing into the opposite direction), increasing the aerodynamical angle of attack either in the upstroke (fa) or downstroke (sub1, sub2) phase. Only one muscle (sub3) is able to reduce the angle of attack during the upstroke — at the same time reducing the speed of the wing (see above).

Contraction of the dorsal longitudinal muscles (dlm) causes the tergum to shift in a caudal and dorsal direction, resulting in a forward

swinging of the wing; most important for this movement is a hinge joint consisting of two single joints both lying at the base of the wing. For mechanical reasons the resulting alteration of the stroke plane angle can only occur at the end of the downstroke — after the 0°-stop of the "Abschlagsdrehbereich" has been reached. The muscle dvm1 (main levator of the flight motor) is able to swing the wing backwards (automatically) at the beginning of the upstroke. Zygoptera and Anisozygoptera (*Epiophlebia*) differ from the Anisoptera in some details (mainly in the metathorax) of this "Vor-Zurückschwing-System" of the wings. In particular they possess direct antagonistic muscles (dlm—pa) in both segments of the pterothorax (in this regard they are considered plesiomorphous). Surprisingly, these muscles show opposite functions in the mesothorax and the metathorax.

Previous studies of skeletal mechanics show widely differing results (compared to one another and to the present study). Various conclusions of these studies concerning the functions of musculature are compared and discussed.

Certain mechanoreceptors, lying in the base of the wing — a chordotonal organ (CH) and two rows of campaniform sensilla (CF1, CF2) — are mechanically stressed during the pronation and supination movements. For example, during pronation-twisting as well as during supination-twisting (beginning at 0°) CH is shortened via two small levers on the underside of the wing, which are in contact with the costal sector or cubital sector respectively. The receptor is stretched during opposite movements, i.e. during supination in the "Abschlagsdrehbereich" and pronation in the "Aufschlagsdrehbereich", and reaches its maximum length at the 0°-stops. In the cuticular zone of the campaniform sensilla (CF1 and CF2) tension stresses (transverse to the long axis of the wing) increase when the wing is twisted (pronated or supinated) and decrease as the geometrical angle of attack falls to 0°. Electrophysiological investigations reveal a strongly phasic response of the CH in both directions of movement for both ranges of rotation. The campaniform sensilla however, which are phasic-tonic, only spike if the wing is twisted. CF1 presumably records the pronation-twisting and CF2 the supination-twisting. These latter receptors could therefore measure the geometrical angle of attack and also indirectly, via the specific patterns and courses of cuticular tensions, provide information con-

cerning the aerodynamical and muscular forces that affect the angle of attack of the wing.

A comparison of the flight apparatus of Odonata, Ephemeroptera and Neoptera reveals possible new homologies and allows of the reconstruction of an ancient flight system of the Pterygota ("Ur-Flugapparat"), which possessed two main axes of wing stroke. The modern forms of the flight apparatus can be derived from this in three functionally differing lines of evolution, which are exclusive of one another. This contradicts the hypothesis of a polyphyle-

tic origin of the Pterygota. However, the problem of the phylogenetic splitting of the Pterygota into three main groups remains unsolved. Within the group \*Odonata, evolutionary developments have mainly concerned the stroke plane angle and the "Vor-Zurückschwingsystem". The latter is present in both mesothorax and metathorax only in the Zygoptera and Anisozygoptera. It is almost entirely lacking in the metathorax of the Anisoptera, which are considered as specialized for forward-thrust flight.

## ABKÜRZUNGEN

A	Analís	hca	hinterer Coxoalarmuskel
a	vorderes pleurales Flügelschlag-Gelenk (p1 bei Odonaten)	hCH	hinterer Hebelsklerit des Chordotonalorgans
A/B	1. Flügel-Schlagachse (durch a und b bestimmt; P1/P2 bei Odonaten)	hCP	hintere Costalplatte
ac <sub>III</sub>	Antecosta des Metatergum	HP	Humeralplatte (dhCP bei Odonaten)
Arc	Arculus (Querader R + M/CuP)	hTS	hinterer Tergalsklerit
arc	Gelenk des Arculus am Radius	kMB	kaudale Media-Basis
B	2. Flügel-Schlagachse (verläuft durch b)	M	Media
B', B"	"Abkömmlinge" der Achse B bei Odonaten (entsprechen P2/C4 und C2/C4)	m	Membranzone in der (medialen) Wand des dvm1-Apodems
b	hinteres pleurales Flügelschlag-Gelenk (p2 bei Odonaten)	mCP	mittlere Costalplatte
BAS	Basis-Sklerit (s. S. 79f.)	MP1	Mittelplatte 1 der Neopteren
BAS <sub>a,b</sub>	Teile des BAS bei Ephemeropteren	ms	Membranspalt am CuSH
basI, II	Basalarklerite der Neopteren	n	Nodus-Gelenk
basI, 2	Basalarmuskeln	P <sub>max</sub>	extrem pronierte Anstellung (Abschlagsdrehbereich)
BF1, 2	Sinnesborstenfelder	p1	vorderes pleurales Flügelschlag-Gelenk, zwischen vGK und CP (mCP)
C	Costa	p2	hinteres pleurales Flügelschlag-Gelenk, zwischen Fulcrum und RAP (Ef)
c	proximales Gelenk der HP (c2 bei Odonaten)	P1/P2	Schlagachse des Flügels (verläuft durch p1 und p2)
c1 (C1)	Gelenk 1 in der CP (zwischen mCP und phCP) — Großbuchstabe kennzeichnet die Drehachse	P2/C4	2. Hauptachse des Abschlagsdrehbereichs (verläuft durch p2 und c4)
c2 (C2)	Gelenk 2 in der CP (zwischen phCP und dhCP) — Großbuchstabe kennzeichnet die Drehachse	pa	Pleuroalarmuskel
c3	Gelenk 3 der CP (zwischen dhCP und CoSB bzw. RAP)	pan <sub>1,2</sub>	primäre Antenodal-Queradern ("primaries")
c4	Gelenk 4 der CP (zwischen dem mCP-Kaudalfortsatz und der RAP; Flügelunterseite)	phCP	proximale hintere Costalplatte
C2/C4	durch die Gelenke c2 und c4 laufende Scharnierachse der Vor-Zurückschwingbewegung	PN	Postnotum
CF1, 2	Felder campaniformer Sensillen	Pt1	Pterale 1
CH	Chordotonalorgan	Pt1 <sub>1,2</sub>	möglicherweise (gemeinsam) dem Pt1 homologe Sklerite bei Ephemeropteren
CoS	Costalsektor	"Pt4"	"Pterale 4" der Ephemeropteren (vgl. S. 85)
CoSB	Costalsektor-Basis	R	Radius
CP	Costalplatte	r	Resilin
CP*	Costalplatte ohne dhCP	RAP	Radioanalplatte
cr <sub>1,2</sub>	Costa-Radius-Queradern	RS	Randsklerit
CuP	Cubitus posterior	S <sub>max</sub>	extrem supinierte Anstellung (Aufschlagsdrehbereich)
CuS	Cubitalsektor	Sc	Subcosta
CuSB	Cubitalsektor-Basis	"ScH"	"Scutellarhebel" der Ephemeropteren (vgl. S. 85)
CuSH	Cubitalsektor-Hebel	sub1-3	Subalarmuskeln
d	distales Gelenk der HP (c3 bei Odonaten)	T	mittlere Tergalregion
dhCP	distale hintere Costalplatte	t1	vorderes Tergalgelenk des Flügels (zwischen Tb und vCP)
dIm	dorsaler Längsmuskel	t2	hinteres Tergalgelenk des Flügels (zwischen TZ und RAP)
dvm1, 2	Dorsoventralmuskeln	T1/T1	Scharnierachse der Tb-Bewegung
e	kaudales Gelenk der Ventralseite des BAS nach distal (in den Flügeln) versetztes Gelenk e bei Odonaten (entspricht c4)	Tb	Tergalbrücke
e'	nach ventral (ins Pleurum) versetztes Gelenk e bei Neopteren	tp	Tergopleuralmuskel
e"	nach ventral (ins Pleurum) versetztes Gelenk e bei Neopteren	"TPM+TWM"	"Ur-Antriebsmechanismus" der Flügel (vgl. S. 78ff.)
e1, 2 (E1, 2)	Scharniergelenke des Epifulcrum — große Buchstaben kennzeichnen die Drehachsen	TPM	Tergalplatten-Mechanismus, Flügelantrieb der Odonaten
Ef	Epifulcrum	TWM1	Tergalwölbungs-Mechanismus (1), Flügelantrieb der Ephemeropteren
F	Fulcrum (hinterer pleuraler Gelenkkopf)	TWM2	Tergalwölbungs-Mechanismus (2), Flügelantrieb der Neopteren
f	ventrales Gelenk des bas I der Neopteren (Kap. 3)	TZ	Tergalzapfen
f	Falz in der RAP-Oberseite (nicht Kap. 3)	vca	vorderer Coxoalarmuskel
fa	Fulcroalarmuskel	vCH	vorderer Hebelsklerit des Chordotonalorgans
tu	basales Biegeelenk des Fulcrum	vCP	vordere Costalplatte
G1, G2	1. und 2. Gelenksklerit der RAP	vGK	vorderer (pleuraler) Gelenkkopf
g	Gelenk zwischen Tb und T	vTS	vorderer Tergalsklerit
HA	Hebelapodem der Tergalbrücke	z	Zone verstärkter Kutikula in der kaudalen RAP



## LITERATUUR

- Asahina, S., 1954. A morphological study of a relic dragonfly *Epiophlebia superstes* Selys (Odonata, Anisozygoptera): 1—153, 70 plates. — Japan. Soc. Promotion Sci., Tokyo.
- Azuma, A., Azuma, S., Watanabe, I., & T. Furuta, 1985. Flight mechanics of a dragonfly. — J. Exp. Biol. 116: 79—107.
- Boettiger, E. G., & E. Furshpan, 1952. The mechanics of flight movements in Diptera. — Biol. Bull. 102: 200—211.
- Brodskyi, A. K., 1970. Organization of the flight system of the mayfly *Ephemera vulgata* L. (Ephemeroptera). — Ent. Rev. Wash. 49: 184—188.
- Chao, H.-F., 1953. The external morphology of the dragonfly *Onychogomphus ardens* Needham. — Smithsonian. misc. Collns 122: 1—56.
- Clark, H. W., 1940. The adult musculature of the anisopterous dragonfly thorax (Odonata, Anisoptera). — J. Morph. 67: 523—565.
- Dubs, F., 1979. Aerodynamik der reinen Unterschallströmung: 1—323. — Birkhäuser Verlag, Basel.
- Erhardt, E., 1916. Zur Kenntnis der Innervierung und der Sinnesorgane der Flügel von Insecten. — Zool. Jb. Anat. 39: 293—334.
- Fraser, F. C., 1957. A reclassification of the order Odonata: 1—133. — R. zool. Soc. New South Wales, Sydney.
- Gettrup, E., 1966. Sensory regulation of wing twisting in locusts. — J. Exp. Biol. 44: 1—16.
- Gewecke, M., Heinzel, H.-G., & J. Philippen, 1974. Role of antennae of the dragonfly *Orthetrum cancellatum* in flight control. — Nature 249: 584—585.
- Hadorn, E., & R. Wehner, 1974. Allgemeine Zoologie: 1—553. — Georg Thieme, Stuttgart.
- Hamilton, K. G. A., 1971. The insect wing, part. I. Origin and development of wings from notal lobes. — J. Kansas Entomol. Soc. 44: 421—433.
- Hatch, G., 1966. Structure and mechanics of the dragonfly pterothorax. — Ann. Ent. Soc. Amer. 59: 702—714.
- Heide, G., 1971. Die Funktion der nicht-fibrillären Flugmuskeln von *Calliphora* (Teil I und II). — Zool. Jb. Physiol. 76: 87—138.
- Hennig, W., 1950. Grundzüge einer Theorie der phylogenetischen Systematik: 1—370. — Deutscher Zentralverlag, Berlin.
- Hennig, W., 1969. Die Stammesgeschichte der Insekten: 1—436. — Waldemar Kramer, Frankfurt/Main (Senckenberg-Buch 49).
- Hennig, W., 1972. Wirbellose II (Gliedertiere): 1—199. — Harri Deutsch, Frankfurt/Main und Zürich.
- Hennig, W., 1982. Phylogenetische Systematik: 1—246. — Paul Parey, Berlin.
- Holst, E. v., 1950. Flugbewegungen bei Insekten. — Hochschulfilm C 575, Inst. f. d. Wiss. Film, Göttingen.
- Kaestner, A., 1972. Lehrbuch der Speziellen Zoologie (Bd. I, Wirbellose 3. Teil, Insecta: A): 1—272. — G. Fischer, Stuttgart.
- Kristensen, N. P., 1975. The phylogeny of hexapod "orders". A critical review of recent accounts. — Z. Zool. Syst. Evolutionsforschung 13: 1—44.
- Kukulová-Peck, J., 1974. Pteralia of the paleozoic insect orders Palaeodictyoptera, Megasecoptera and Diaphanopteroidea (Paleoptera). — Psyche, Camb. 81: 416—430.
- Kukulová-Peck, J., 1978. Origin and evolution of insect wings and their relation to metamorphosis, as documented by the fossil record. — J. Morph. 156: 53—126.
- Kukulová-Peck, J., 1983. Origin of the insect wing and wing articulation from the arthropodan leg. — Can. J. Zool. 61: 1618—1669.
- Kukulová-Peck, J., & E. S. Richardson, Jr., 1983. New Homiopteridae (Insecta: Paleodictyoptera) with wing articulation from Upper Carboniferous strata of Mazon Creek, Illinois. — Can. J. Zool. 61: 1670—1687.
- Matsuda, R., 1970. Morphology and evolution of the insect thorax. — Memoirs of the Entomological Society of Canada, 76: 1—431. — Ottawa.
- Matsuda, R., 1979. Morphologie du thorax et des appendices thoraciques des insectes. — In: P. Grassé (ed.), Traité de Zoologie 8, fasc. 8. Masson, Paris: 1—289.
- Matsuda, R. 1981. The origin of insect wings (Arthropoda: Insecta). — Int. J. Insect Morphol. & Embryol. 10: 387—398.
- Mickoleit, G., 1969. Vergleichend-anatomische Untersuchungen an der pterothorakalen Pleurotergalmuskulatur der Neuroptera und Mecoptera (Insecta, Holometabola). — Z. Morph. Tiere 64: 151—178.
- Mittelstaedt, H., 1950. Physiologie des Gleichgewichtssinnes bei fliegenden Libellen. — Z. vergl. Physiol. 32: 422—463.
- Möhl, B., 1979. High-frequency discharge of the locust wing hinge stretch receptor during flight. — Naturwissenschaften 66: 158.
- Nachtigall, W., 1968. Gläserne Schwingen: 1—158. — H. Moos, München.
- Nachtigall, W., & D. M. Wilson, 1967. Neuro-muscular control of dipteran flight. — J. Exp. Biol. 47: 77—97.
- Neville, A. C., 1960. Aspects of flight mechanics in anisopterous dragonflies. — J. Exp. Biol. 37: 631—656.
- Norberg, R. Å., 1975. Hovering flight of the dragonfly *Aeschna juncea* L., kinematics and aerodynamics. — In: Wu, T.Y.-T. et al. (ed.): Swimming and flying in nature, 2. Plenum Publ. Corp., New York: 763—781.
- Pfau, H. K., 1971. Struktur und Funktion des sekundären Kopulationsapparates der Odonaten (Insecta, Palaeoptera), ihre Wandlung in der Stammesgeschichte und Bedeutung für die adaptive Entfaltung der Ordnung. — Z. Morph. Tiere 70: 281—371.

- Pfau, H. K., 1973. Fliegt unsere Schmeißfliege mit Gangschaltung? — *Naturwissenschaften* 60: 160.
- Pfau, H. K., 1975. Zwei neue Kleinlibellen (Odonata, Zygoptera — möglicherweise Platynemididae) aus dem baltischen Bernstein. — *Stuttgarter Beitr. Naturk., Ser. A*, 270: 1—7.
- Pfau, H. K., 1977a. Funktion einiger direkter, tonischer Flügelmuskeln von *Calliphora erythrocephala* Meig. — *Verh. Dtsch. Zool. Ges.* 1977: 275. — Stuttgart.
- Pfau, H. K., 1977b. Zur Morphologie und Funktion des Vorderflügels und Vorderflügelgelenks von *Locusta migratoria* L. — *Fortschr. Zool.* 24: 341—345.
- Pfau, H. K., 1978a. Funktionsanatomische Aspekte des Insektenflugs. — *Zool. Jb. Anat.* 99: 99—108.
- Pfau, H. K., 1978b. Bedeutung des Vorderflügel-Streckrezeptors und -Chordotonalorgans für die Registrierung der geometrischen Flügelanstellung bei *Locusta migratoria* L. — *Verh. Dtsch. Zool. Ges.* 1978: 247. — Stuttgart.
- Pfau, H. K., 1983. Mechanik und sensorische Kontrolle der Flügel-Pronation und -Supination. — In: W. Nachtigall (ed.), *Biona-report 1*. G. Fischer, Stuttgart: 61—77.
- Pfau, H. K., in Vorb. Vergleichende Untersuchung der Flügel-Pronation und -Supination bei vier neopteren Insekten (*Locusta*, *Cetonia*, *Apis*, *Calliphora*).
- Pfau, H. K., Schroeter, B., & E. Steitz, 1977. Der Klickmechanismus der Fliege — ein Demonstrationsmodell. — *Biologie in unserer Zeit* 6: 188—190.
- Pfau, H. K., & K. Honomichl, 1979. Die campaniformen Sensillen des Flügels von *Cetonia aurata* L. und *Geotrupes silvaticus* Panz. (Insecta, Coleoptera) in ihrer Beziehung zur Flügelmechanik und Flugfunktion. — *Zool. Jb. Anat.* 102: 583—613.
- Pfau, H. K., & W. Nachtigall, 1981. Der Vorderflügel großer Heuschrecken als Luftkraftezeuger. II. Zusammenspiel von Muskeln und Gelenkmechanik bei der Einstellung der Flügelgeometrie. — *J. Comp. Physiol.* 142: 135—140.
- Pringle, J. W. S., 1957. *Insect Flight*: 1—133. — University Press, Cambridge.
- Riek, E. F., & J. Kukulová-Peck, 1984. A new interpretation of dragonfly wing venation based upon Early Upper Carboniferous fossils from Argentina (Insecta: Odonatoidea) and basic character states in pterygote wings. — *Can. J. Zool.* 62: 1150—1166.
- Risler, H., in Vorb. Das Chordotonalorgan im Flügel von *Anax imperator* Leach (Insecta, Odonata).
- Rüppell, G., 1981. *Aeschna cyanea* (Aeschnidae), Flugverhalten. — Hochschulfilm E 2712, Inst. f. d. Wiss. Film, Göttingen.
- Russenberger, H., & M. Russenberger, 1959/60. Bau und Wirkungsweise des Flugapparates von Libellen mit besonderer Berücksichtigung von *Aeschna cyanea*. — *Mitt. naturf. Ges. Schaffhausen* 27: 1—88.
- Savage, S. B., Newman, B. G., & D. T.-M. Wong, 1979. The role of vortices and unsteady effects during the hovering flight of dragonflies. — *J. Exp. Biol.* 83: 59—77.
- Schlee, D., 1971. Die Rekonstruktion der Phylogenese mit Hennig's Prinzip: 1—62. — Waldemar Kramer, Frankfurt/Main.
- Schneider, P., & I. Günther, 1978. Präzisionsarbeit der Natur—Flugmaschine Insekt. — *Bild der Wissenschaft* 3: 60—70.
- Seifert, G., 1975. *Entomologisches Praktikum*: 1—430. — Georg Thieme, Stuttgart.
- Simmons, P. J., & I. 1978. Crevice organs: Sensory structures on the wings of dragonflies (Insecta, Odonata). — *Zoomorphologie* 89: 251—255.
- Snodgrass, R. E., 1929. The thoracic mechanism of a grasshopper, and its antecedents. — *Smithson. misc. Collns* 82 (2): 1—111.
- Snodgrass, R. E., 1935. *Principles of insect morphology*: 1—667. — McGraw-Hill, New York and London.
- Snodgrass, R. E., 1958. Evolution of arthropod mechanisms. — *Smithson. misc. Collns* 138 (2): 1—77.
- Sveshnikov, V. G., 1973. Structure and functional characteristics of head receptors controlling the operation of the wing muscles in the dragonfly *Aeschna grandis*. — *J. evol. Biochem. Physiol.* 8: 466—471.
- Tannert, W., 1958. Die Flügelgelenkung bei Odonaten. — *Dtsch. ent. Z. (N.F.)* 5: 394—455.
- Weber, H., 1933. *Lehrbuch der Entomologie*: 1—726. — G. Fischer, Stuttgart.
- Weis-Fogh, T., 1956. *Biology and physics of locust flight*. IV. Notes on sensory mechanisms in locust flight. — *Philos. Trans. R. Soc. Lond. (Biol.)* 239: 553—584.
- Weis-Fogh, T., 1973. Quick estimates of flight fitness in hovering animals, including novel mechanisms for lift production. — *J. Exp. Biol.* 59: 169—230.
- Weis-Fogh, T., & M. Jensen, 1956. *Biology and physics of locust flight*. I. Basic principles in insect flight. A critical review. — *Philos. Trans. R. Soc. Lond. (Biol.)* 239: 415—458.
- Wilson, D. M., 1962. Bifunctional muscles in the thorax of grasshoppers. — *J. Exp. Biol.* 39: 669—677.
- Wilson, D. M., & T. Weis-Fogh, 1962. Patterned activity of co-ordinated motor-units, studied in flying locusts. — *J. Exp. Biol.* 39: 643—667.
- Zill, S. N., & D. T. Moran, 1981. The exoskeleton and insect proprioception. I. Responses of tibial campaniform sensilla to external and muscle-generated forces in the American cockroach, *Periplaneta americana*. — *J. Exp. Biol.* 91: 1—24.















QL  
461  
T568  
Ent.

# TIJDSCHRIFT VOOR ENTOMOLOGIE

UITGEGEVEN DOOR

DE NEDERLANDSE ENTOMOLOGISCHE VERENIGING



## INHOUD

- J. C. ROSKAM. — Biosystematics of insects living in female birch catkins. IV. Egg-larval parasitoids of the genera *Platygaster* Latreille and *Metaclisis* Förster (Hymenoptera, Platygastridae), pp. 125—140, figs. 1—44.





# BIOSYSTEMATICS OF INSECTS LIVING IN FEMALE BIRCH CATKINS. IV. EGG-LARVAL PARASITIDS OF THE GENERA *PLATYGASTER* LATREILLE AND *METACLISIS* FÖRSTER (HYMENOPTERA, PLATYGASTRIDAE)

by

J. C. ROSKAM

*Division of Population Biology, University of Leiden, The Netherlands*

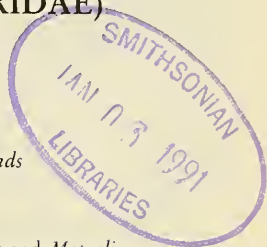

## ABSTRACT

Adult and larval stages of *Platygaster betularia* Kieffer, *P. betulae* (Kieffer) and *Metaclisis phragmitis* Debauche are described. These species are egg-larval parasitoids of three gall midge species, which belong to the genus *Semudobia* Kieffer (Diptera, Cecidomyiidae), in fruit catkins of *Betula* (Betulaceae). The various developmental stages of the *Platygaster* species are discriminated with the help of multivariate methods. Phenology, host specificity and effects upon host density have been investigated. All platygastroid parasitoids develop highly synchronized with their hosts. *Platygaster betularia* and *P. betulae* have mutually exclusive host preferences. Both *Platygaster* species are important mortality factors particularly able to eliminate moderate host densities. Speciation patterns in *Semudobia* and *Platygaster* have no parallel traits and can, therefore, not be regarded as results of a co-evolutionary process. Some notes are included about platygastroid parasitoids of Nearctic *Semudobia* species and of inquiline *Dasineura* gall midges in birch catkins.

## INTRODUCTION

Gall midges allied with female birch catkins are frequently attacked by parasitoids belonging to the hymenopterous superfamilies Scelionioidea and Chalcidoidea. The scelionoid representatives are the object of this study. They are egg-larval endoparasitoids: the eggs are laid in the host egg, but further development does not occur before the host is in its final instar. Until then parasitized hosts can not be distinguished from healthy ones. Parasitized early final instar hosts become inert and further development eventually ceases. One, or sometimes two larvae are visible inside the host, consuming all of the host's body contents within a few days. The skin of the host larva remains as a "cocoon", providing an extra protection for the mature parasitoid larva, in which it pupates.

Kieffer (1916) described two platygastroid parasitoids of *Semudobia betulae* (Winnertz) s.l., viz., *Platygaster betularia* Kieffer and *Misocyclops betulae* Kieffer. According to current opinion, also adopted in this paper, *Platygaster* Latreille and *Misocyclops* Kieffer are synony-

mous, because male diagnostic characters do not allow a grouping of the involved species into two genera<sup>1</sup>). Fulmek's (1968) compilation excepted, later reports on egg-larval parasitoids of *Semudobia* mention only *P. betularia* (Barnes, 1951; Bachmaier, 1965). Hodges (1969) treated the life-history of this parasitoid. All these authors considered the gall midge fauna of female birch catkins as relatively simple: *Semudobia betulae*, the gall maker, is accompanied by a saprophagous and a predaceous gall midge species, viz., *Clinodiplosis cilicrus* (Kieffer) and *Lestodiplosis* cf. *vorax* (Rübsaamen), respectively. Roskam (1977, 1979) and Roskam & van Uffelen (1981), however, arrived at the conclusion that at least five gall inducing *Semudobia* species and two inquiline *Dasineura* species are specialized on female birch catkins. *Clinodiplosis cilicrus* and *Lestodiplosis* cf. *vorax* are frequently present in this biocoenosis. The advancement of knowledge at the gall midge level provided a basis for further research of the parasitoids and the results of this study are now presented for the egg-larval parasitoids.

*Platygaster betularia* and *P. betulae* are both abundant in the Palaearctic entomofauna of female birch catkins. Among other things they are

<sup>1</sup>) A formal synonymy will be proposed by Mr. H. J. Vlug, Wageningen (pers. comm.).

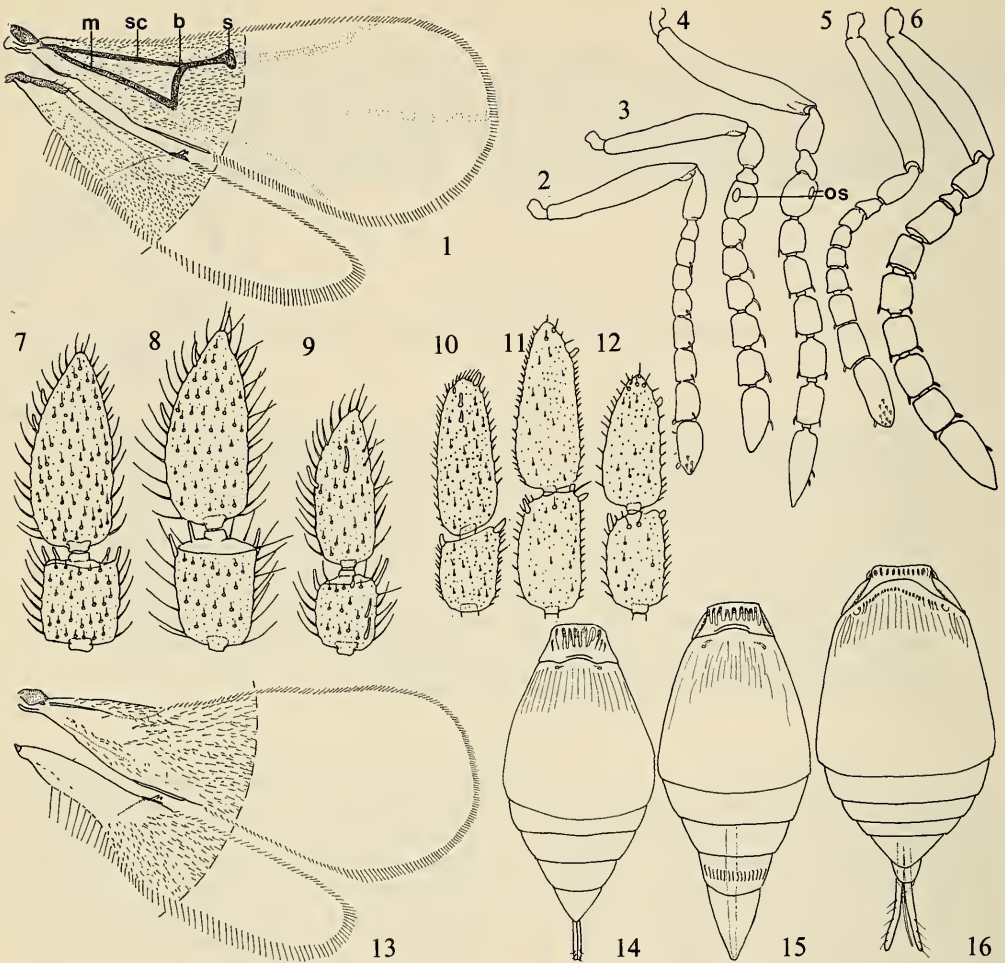

Figs. 1—16. Adult platygastroid characters. 1, 13, fore and hind wing, female; 2, 5, antenna, female; 3, 4, 6, antenna, male; 7—9, ultimate and penultimate antennal segments, male; 10—12, ditto, female; 14—16, gaster, female. 1, 5—7, 10, 16, *Metaclisis phragmitis*; 2, 3, 9, 12—14, *Platygaster betularia*; 4, 8, 11, 15, *P. betulae*. b, basal vein; m, medial vein; os, oval sensilla; s, stigma; sc, subcostal vein. 1, 13—16,  $\times 60$ ; 2—6,  $\times 96$ ; 7—12,  $\times 240$ .

characterized by different host associations: *P. betularia* has only been reared from *S. betulae* (Winnertz) s.s. and *S. skuhravae* Roskam, whereas *P. betulae* is restricted to *S. tarda* Roskam. *Metaclisis phragmitis* Debauche has been reared from both *S. betulae* and *S. tarda*. Also the Nearctic gall midge *S. brevivalpis* Roskam is attacked by a platygastroid: mature larvae have been found in one collection. These larvae are very aberrant in shape and belong to an undescribed genus.

*Dasineura* species have other platygastroid parasitoids. Because mature *Dasineura* larvae drop to the ground for hibernation, it was not

possible to rear parasitoid full grown larvae and adults from these inquilines. However, in *Dasineura* larvae two different forms of platygastroid larvae have been observed: the first putatively belongs to *Piestopleura* cf. *mamertes* (Walker), the second could not be combined with adult platygastroids frequenting female birch catkins. No platygastroid parasitoids have been found in *Clinodiplosis* and *Lestodiplosis* larvae.

#### MATERIAL AND METHODS

Immature stages. — Galls of different *Semudobia* species have different shapes and can therefore be sorted according to the gall induc-

ing midge species (Roskam, 1977). In order to detect the parasitoids, the host larvae were dissected from identified galls and macerated in warm 80% lactic acid. *Platygastrid* larvae were taken from opened hosts and slide-mounted in polyvinyl-lactophenol. Galls were also collected from dry herbarium material. Then 10% KOH was used for maceration.

Adults. — Adults were collected by rearing them from samples of identified galls, and by collecting ovipositing females from female catkins with an exhauster. This material was either stored in 80% ethanol, or mounted on tags, or dissected and slide-mounted in euparal. Specimens representing all stages of the studied species have been deposited in the collection of the Rijksmuseum van Natuurlijke Historie, Leiden.

Phenological observations on immature stages were made by analyzing samples of ten fruit catkins each. The samples were collected weekly from the beginning of March until the end of September. Adults were caught from mid-April until the end of May. Every day, during a period of ca. 30 min. around noon, about twenty female wasps and a similar sample of gall midges were collected and subsequently identified.

Host-parasitoid specificity was determined by rearing adult parasitoids from gall samples sorted according to the gall maker. Mortality caused by parasitoids was defined by dissecting gall samples that had been collected in December. All seasonal activities have then ended, but many fruit catkins are still complete and can be collected from the trees.

An extensive description of the study-areas Meijendel (52.08N 4.20E), Duivenvoorde (52.06N 4.24E), Kootwijk (52.11N 5.46E), Ilperveld (52.29N 4.58E) and Nieuwkoop (52.10N 4.50E) was given in Roskam (1977); Hulshorst (52.22N 5.44E) and Kootwijk are dry areas on sand.

#### ADULTS

Adults of species belonging to *Platygaster* were described by Kieffer (1926) and those of *Metaclisis phragmitis* by Debauche (1947). Therefore, attention will be paid here only to some differential characters.

*Metaclisis*. — (figs. 1, 5—7, 10, 16). Fore wing with subcostal and medial vein, basal vein indicated by a more or less distinct dark streak, subcostal vein terminated by a distinct stigma, which does not reach the front margin of the wing. Second (sex) flagellomere in male as wide

as third, without large, oval sensilla. Proximal part of female second gastral tergite broad, about  $\frac{2}{3}$  as wide as distal part. Sheaths of ovipositor exposed.

*Platygaster*. — (figs. 2—4, 8, 9, 11—15). Wing venation reduced. Second (sex) flagellomere of male wider than third, with large, oval sensilla. Proximal part of female gastral tergite about half the width of the distal part.

*P. betularia*. — Males. Flagellomeres subquadrate, length of fifth flagellomere less than 1.4 times its width in lateral view (fig. 3). Proximal part of scutellum rather dull, due to relatively rich setation (fig. 37).

Females. Scutellum as in male (fig. 39). Gaster twice as long as wide, gradually narrowing towards its apex (fig. 14); exposed part of fifth and sixth segments about a fifth (0.19—0.22,  $n=5$ ) the length of the gaster without ovipositor; surface of fifth segment shiny, without any sculpture.

*P. betulae*. — Males. Flagellomeres oblong, length of fifth flagellomere more than 1.4 times its width in lateral view (fig. 4). Proximal part of scutellum shiny, due to relatively sparse setation (fig. 38).

Females. Scutellum as in male (fig. 40). Gaster

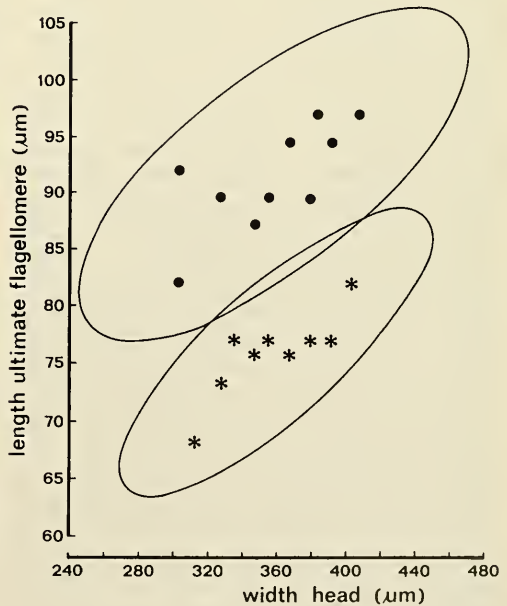

Fig. 17. Species differences in *Platygaster* females. The ellipses indicate 95% confidence limits. Dots, *P. betulae*; asterisks, *P. betularia*.



Table 1. Mean values ( $\bar{x}$ ) and standard deviations (s) of adult characters, measurements in  $\mu\text{m}$ .

CHARACTER	MALES							FEMALES						
	<i>P. betularia</i>		<i>S. skuhravae</i>		<i>P. betularia</i>		% overlap <i>P. betulae/b-aria</i>	<i>P. betularia</i>		<i>S. skuhravae</i>		<i>P. betularia</i>		% overlap <i>P. betulae/b-aria</i>
	$\bar{x}$	s	$\bar{x}$	s	$\bar{x}$	s		$\bar{x}$	s	$\bar{x}$	s	$\bar{x}$	s	
width head	366.6	31.9	369.0	22.2	377.5	25.0	42.9	336.1	23.4	358.7	28.4	357.4	35.5	49.2
length gaster	557.2	55.9	550.8	35.4	544.4	19.5	47.4	590.9	49.1	633.1	60.1	736.0	89.2	24.9
length ult. flagellomere	92.0	6.1	90.8	4.1	106.6	6.1	6.7	75.9	2.9	76.4	3.8	92.0	4.6	3.3
length 4 <sup>th</sup> flagellomere	47.8	5.4	44.7	4.3	58.8	5.5	7.7	45.4	3.5	46.1	5.1	52.7	6.6	28.8
width 4 <sup>th</sup> flagellomere	36.6	3.2	35.6	4.2	37.4	7.4	35.7	28.3	1.7	27.8	2.4	29.0	3.1	41.3

more than twice as long as wide (5:2), distinctly narrowed between fourth and fifth segment (fig. 15); exposed part of fifth and sixth segments about 0.3 times (0.26—0.31, n=5) the length of the gaster without ovipositor; surface of fifth gastral segment with band of longitudinal striae.

Means and standard deviations of five variates for different host species of *Platygaster*, as well as for different host groups of *P. betularia*, are presented in table 1. Interspecific percentages of overlap, or percentages of misclassification, are lowest for the length of the ultimate flagellomere, as well in males, as in females. This character provides therefore the best univariate discrimination of *P. betularia* and *P. betulae*. A more powerful interspecific discrimination is obtained by various combinations of character pairs: (width head — length ultimate flagellomere), (width head — length fourth flagellomere), (length gaster — length ultimate flagellomere) and (length fourth flagellomere — width same segment) in males; (width head — length ultimate flagellomere) in females. All these combinations provide amounts of misclassification below 1%. The latter combination is plotted in fig. 17. For explanation of the technique, univariate as well as bivariate, see Lubischew (1962). In order to obtain the best separation between the two *Platygaster* species, a multivariate function, viz., discriminant analysis, was carried out. This technique has been explained by Pimentel (1979) and was applied by Roskam (1982). Percentages of misclassification after application of discriminant analysis remained 0.02 in males and 0.17 in females. In table 2 the values of the character set are summarized. In males, the length of the fourth flagellomere contributes most to discrimination, whereas in females, as

was expected on results of univariate analysis, the length of the ultimate flagellomere is most important for species discrimination: these characters scored the highest values as coefficients for the canonical variates, 0.5198 and 0.2914, respectively. The canonical score Z (sum of the products of character values and corresponding coefficients for canonical variates, table 2) is plotted in fig. 41. Identification of new specimens is possible by calculating their canonical score Z (Bigelow & Reimer, 1954; Roskam, 1982). Such identification runs then as follows:

- Z males = (length fourth flagellomere) + 0.32 (length ultimate flagellomere) - 0.21 (width head) < 4  
..... *P. betularia*
- Z males = Idem > 4 ..... *P. betulae*
- Z females = (length ultimate flagellomere) + 0.47 (length fifth flagellomere) - 0.68 (width fourth flagellomere) < 84  
..... *P. betularia*
- Z females = Idem > 84 ..... *P. betulae*

*P. betularia* has been reared in considerable numbers from two different hosts, *Semudobia skuhravae* and *S. betulae*. No discrimination between specimens reared from different hosts was possible in an univariate way (table 1). Also in a multivariate way, viz., discriminant analysis, no discrimination was possible between subgroups of *P. betularia* which developed in different host species: in males misclassification remained 40.5%; in females 32.3%. Hence, the influence of the host on the adult morphology of *P. betularia*, if present, is very small and remains below the resolving power of even this sophisticated technique.

Table 2. Summary of discriminant analyses. Values in brackets not used for calculation of canonical score Z. For further explanation, see text.

CHARACTER	coefficients for canonical variates	percentage of contribution	percentage of variation load
<b>LARVAE</b>			
length mandible	0.0995	18.10	8.63
diameter stigma Th 2	-0.1446	38.20	4.18
height tergal gland	-0.1547	43.70	97.32
<b>MALES</b>			
width head	-0.1080	3.72	3.60
length gaster	(-0.0116)	(0.04)	(0.51)
length ult. flagellomere	0.1666	8.84	75.55
length 4 <sup>th</sup> flagellomere	0.5198	86.10	73.93
width 4 <sup>th</sup> flagellomere	(-0.0638)	(1.30)	(14.03)
<b>FEMALES</b>			
width head	(-0.0833)	(4.53)	(0.04)
length gaster	(-0.0192)	(0.25)	(36.01)
length ult. flagellomere	0.2914	56.75	84.43
length 4 <sup>th</sup> flagellomere	0.1358	12.33	27.46
width 4 <sup>th</sup> flagellomere	-0.1974	26.04	5.44

## IMMATURE STAGES

The larval phase of many *Platygastridae* is characterized by hypermetamorphosis: there are two distinct larval stages, which are very different in shape (Leiby & Hill, 1924).

First instar larvae of forms in which hypermetamorphosis occurs have a cyclopid shape (figs. 21—23). They consist of a cephalothorax with huge mandibles to which a slender, 5—7 segmented abdomen is attached. Antennae are simple, conical. The surrounding of the mouth is sclerotized and differently shaped in the various forms (figs. 18—20). Maxillary sensillae are only distinct in the form attributed to *Piostopleura* (fig. 22). In this form the cephalothorax bears two pseudopodia. In *Metaclisis* the abdominal segments are simple, whereas in cf. *Piostopleura* they seem to be secondarily subdivided. The final segment of *Metaclisis* is bilobed,

in cf. *Piostopleura* it is simple, with its surface covered with small spinules. Stigmata are lacking.

*Platygaster* does not pass a cyclopid stage. In this genus, the final larval stage is preceded by a peculiar V-shaped structure (fig. 25). In the central "nodule" of this structure the embryo apparently develops, whereas the two arms of the "V" may function as teratocytes, structures immobilizing the endocrine system of the host and/or immunizing its encapsulating relations (Salt, 1968; Vinson & Iwantsch, 1980). The evidence, that these V-shaped structures do not belong to the normal development of the host *Semudobia* is that in some instances the nodule becomes encapsulated by melanin. Although some extensive reports on early developmental stages of *Platygaster* exist (Marchal, 1906; Silvestri, 1916; Leiby & Hill, 1924; Hill & Emery,

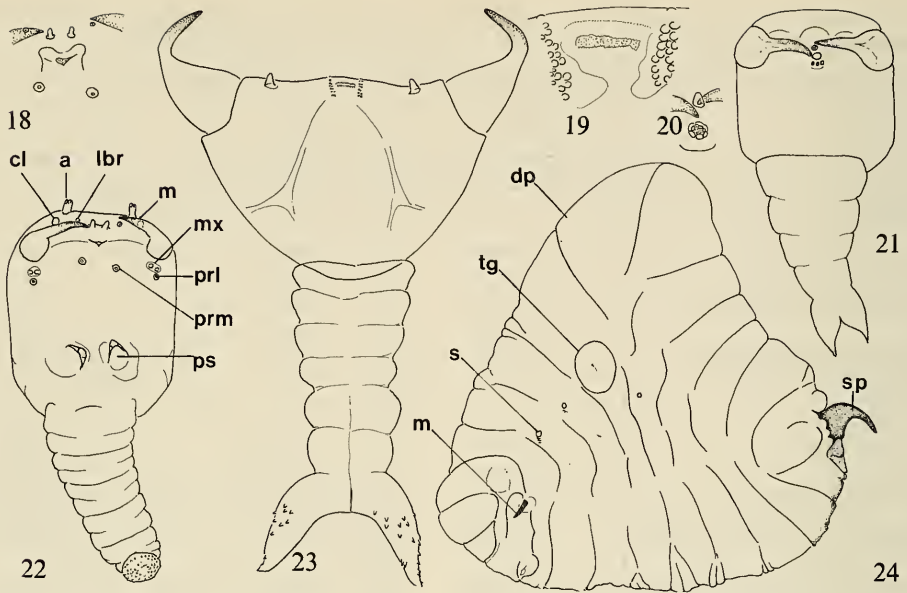

Figs. 18—24. Larval platygastroid characters. 18—20, detail of oral region; 21—23, cyclopid larval stage, ventral aspect; 24, full grown larval stage, lateral aspect. 18—22, endoparasitoids of *Dasineura interbracta*; 23, *Metaclisis phragmitis*; 24, endoparasitoid of *Semudobia brevipalpis*. a, antenna; cl, clypeal sensilla; dp, dorsal protuberance; lbr, labral sensilla; m, mandible; mx, maxillary sensilla; prl, lateral prelabial sensilla; prm, median prelabial sensilla; ps, pseudopodium; s, stigma; sp, spine-like outgrowth. 23, 24  $\times 100$ ; 21, 22,  $\times 240$ ; 18—20,  $\times 400$ .

1937; Clausen, 1956), V-shaped structures, in connexion to platygastroid parasitation, remained unobserved.

After a moulting, final instar larvae develop from these primary stages. The terminology of the structures has been treated by Roskam (1982). The final larval stage is apodous and consists of a head, three thoracic segments (Th 1—3) and seven or eight abdominal segments (A 1—8) of which the final one is the anal segment (AS). The antennae are simple and inconspicuous. The clypeus bears one pair of papillae on which a seta may be developed. Mandibles are distinct. No sensillae are visible on the underlip complex.

Second and third thoracic segments, and the second abdominal segment bear a pair of functional stigmata (figs. 26—27); the first abdominal segment, and in *Metaclisis* also the abdominal segments A 3—5, bear an oval, shallow, plate-like structure, in the centre of which a vestigial stigma is present (fig. 31). Silvestri (1916) made histological cross sections of these structures and named them tergal glands. He supposed these glands to have a function during pupation of the parasitoid. Rows of papillae are

present on dorsal, pleural and ventral surfaces of the body segments. Final instar larvae of *Metaclisis*, the two *Platygaster* species and the Nearctic form differ as follows.

*Metaclisis phragmitis* (figs. 26, 30, 33, 35—36). — Clypeal papillae with short seta. Mandibles small and curved (fig. 30). Eight abdominal segments present, with tergal glands on A 1, A 3—5. Papillary pattern rather complete, with one pair of rows of dorsal papillae, one pair of rows of pleural papillae and one pair of rows of sternal papillae (on thoracic segments) and ventral papillae (on abdominal segments). Two pairs of terminal papillae on dorsal surface of the anal segment. Dorsal papillae lacking on A 6 and A 7, pleural papillae sometimes doubled on Th 2 and Th 3. Ventral body surface with rounded verrucae.

*Platygaster* (figs. 27, 28, 31, 32, 34). — Clypeal papillae without seta. Mandibles straight and about twice as large as those of *Metaclisis* (fig. 28). Seven abdominal segments present, with tergal glands on A 1 only. Papillary pattern reduced and variable. Dorsal papillae usually absent. Pleural papillae only on Th 2 and Th 3 and, two pairs, on A 7. Sternal papillae,



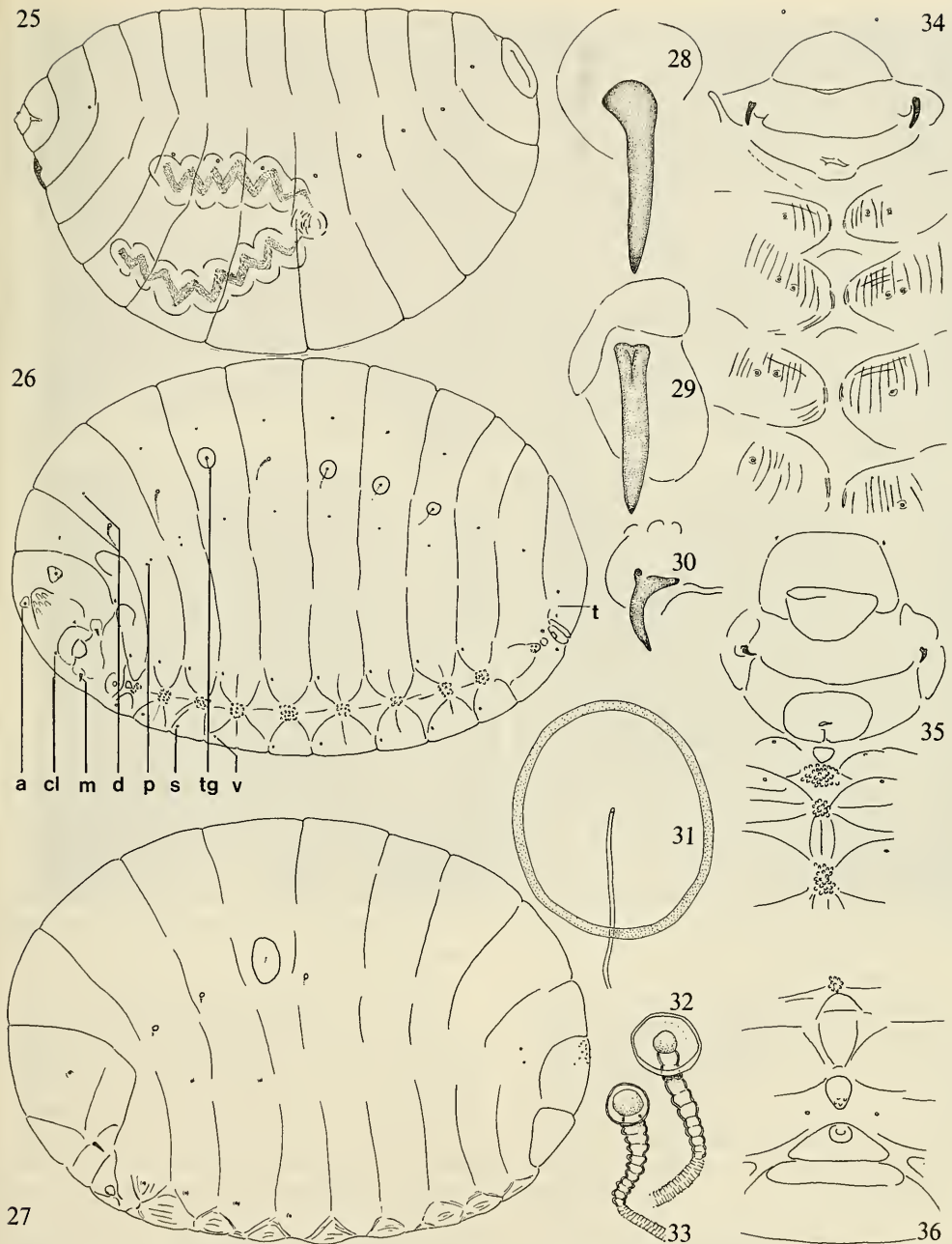

Figs. 25—36. Larval platygastroid characters. 25, third instar host larva with V-shaped endoparasitoid stage, lateral aspect; 26, 27, full grown endoparasitoid larva, latero-ventral aspect; 28—30, mandible of full grown endoparasitoid larva; 31, tergal gland on first abdominal segment of full grown larva; 32, 33, stigma on second thoracic segment of full grown larva; 34, 35, head and sternal aspect of full grown larva; 36, ultimate and penultimate segments of full grown larva, ventral aspect. 26, 30, 33, 35, 36, *Metaclisis phragmitis*; 25, 27, 28, 31, 32, 34, *Platygaster betularia*; 29, platygastroid endoparasitoid of *Semudobia brevipalpis*. a, antenna; cl, clypeal sensilla; d, dorsal papilla; m, mandible; p, pleural papilla; s, sternal papilla; t, terminal papilla; tg, tergal gland; v, ventral papilla. 25,  $\times 50$ ; 26, 27,  $\times 60$ ; 34—36,  $\times 150$ ; 28—33,  $\times 720$ .

Table 3. Mean values ( $\bar{x}$ ) and standard deviations (s) of larval characters, measurements in  $\mu\text{m}$ . *Metaclisis*, *Platygaster* and a Nearctic platygastrid.

CHARACTER	METACLISIS		PLATYGASTER		NEARCTIC FORM	
	$\bar{x}$	s	$\bar{x}$	s	$\bar{x}$	s
length mandible	19.5	1.4	41.1	3.5	35.7	3.5
diameter stigma Th 2	8.7	0.8	13.0	1.6	10.4	1.4
height tergal gland	43.9	4.8	94.2	13.0	70.2	4.7
n	15		24		9	

sometimes doubled (fig. 34), on all thoracic segments, ventrals only on A 1. Scattered spinules developed on dorsal surface of AS. Ventral surface of body segments with longitudinal striae.

Nearctic form (figs. 24, 29). — No papillae visible, neither on clypeus, nor on body segments. Mandibles straight and resembling those of *Platygaster* (fig. 29). Seven abdominal segments present, with tergal glands on A 1 only. Anal segment with a huge, heavily sclerotized spine-like outgrowth (fig. 24: sp). In lateral aspect the larvae are triangular, by a bizarre, allometric enlargement of the median protuberance between A 1 and A 2. Body surface without cuticular sculptures as verrucae and striae; ventral surface of A 5 slightly sclerotized.

Means and standard deviations of the length of mandibles, the diameter of the stigma of Th 2 and the height of the tergal gland of A 1 are presented for *Metaclisis*, *Platygaster* and the Nearctic form in table 3. Table 4 presents the same variates for larvae of *Platygaster*, dissected from *Semudobia betulae* (= *P. betularia*) and *S. tarda* (= *P. betulae*). Contrary to the results regarding intergeneric discrimination, only the height of the tergal gland provides discrimination at the species level. As in adults, discriminant analysis provides the best separation between larvae

of *P. betulae* and *P. betularia*, although some overlap (6.36%) remains. In table 2 a summary of values of the character set is given. The height of the tergal gland contributes most to the discrimination of the two species. In other words, specimens with high values for the height of the tergal gland and low values for the length of the mandibles belong to *P. betulae*, whereas specimens with the inverse combination of values belong to *P. betularia*. The canonical score from the discriminant analysis is plotted in fig. 41. New specimens may be identified by calculating their canonical score Z as follows:

$$Z \text{ larvae} = (\text{height tergal gland}) + 0.94 (\text{diameter stigma Th 2}) - 0.64 (\text{length mandible}) > 80 \quad P. betulae$$

$$Z \text{ larvae} = \text{Idem} < 80 \dots\dots\dots P. betularia$$

Because no discrimination was possible between adult subgroups of *P. betularia* that developed in the different host species *S. betulae* and *S. skubravae*, such an analysis for the larval stages was omitted.

#### PHENOLOGY, GEOGRAPHICAL DISTRIBUTION AND FURTHER BIOLOGICAL NOTES

Phenological observations were made during 1972 and 1985 (figs. 42 and 43, respectively). Because the early larval stages of *Semudobia*

Table 4. Mean values ( $\bar{x}$ ) and standard deviations (s) of larval characters, measurements in  $\mu\text{m}$ . *Platygaster* species. (nd), overlap very large, not defined.

CHARACTER	<i>P. betularia</i>		<i>P. betulae</i>		% overlap
	$\bar{x}$	s	$\bar{x}$	s	
length mandible	40.4	4.8	42.3	2.4	40.3
diameter stigma Th 2	12.8	1.0	13.4	2.1	(nd)
height tergal gland	81.6	8.3	105.6	5.7	4.8
n	9		10		





Figs. 37—40. Adult scutellum, propodeum and first gastral tergite. 37, *Platygaster betularia*, male; 39, ditto, female; 38, *P. betulae*, male; 40, ditto, female.  $\times 250$ .

species and *Platygaster* species are difficult to identify during mass inspections, the 1972 results are not presented for the separate species. The 1985 results, specified for the species involved, show that the interspecific differences concerning the flight period are small, for *Semudobia*, as well as for *Platygaster*. *P. betularia*, the most abundant parasitoid in Meijndel, appeared first, followed by *P. betulae*. *M. phragmitis* is the last one, but differed only five days with *P. betularia*. All parasitoid species have a considerably longer flight period than their hosts. The slight difference between *P. betularia* and *P. betulae* is corresponding to the difference of maximum activity of their respective hosts, *S. betulae* and *S. tarda*.

Adult stages of gall midges, as well as of para-

sitoids, appeared about a fortnight earlier in 1972 than in 1985, probably due to the very cold spring of the latter year. Furthermore, adult gall midge activity lasted considerably longer in 1972 than in 1985, as did, to a lesser extent, the activity of the platygastriids. A possible explanation for the latter difference may be the great variation of the maximum temperature in 1985: a short period of very warm weather (17—19 May;  $t_{\max} = 25^{\circ}\text{C}$ ) was followed by an extraordinarily cold period (23—24 May;  $t_{\max} = 12^{\circ}\text{C}$ ).

*Platygaster* — In the field, adult emergence coincides with the appearance of *Semudobia* females. Ovipositing gall midges and parasitoids frequently occur together on the same flowering birch catkin, but in other instances *Platygaster*



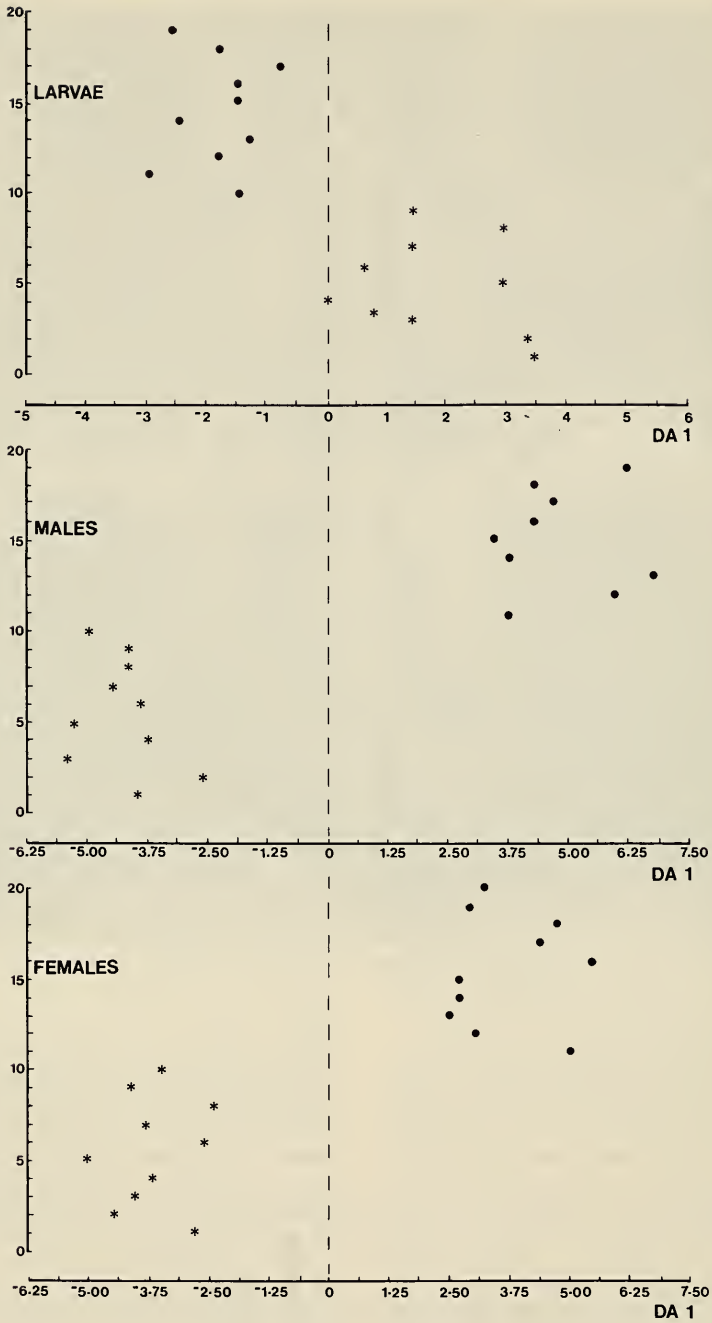

Fig. 41. Two group discriminant space. Y-axis represents only the sequence of specimens. DA 1, first discriminant axis; dots, *Platygaster betulae*; asterisks, *P. betularia*.

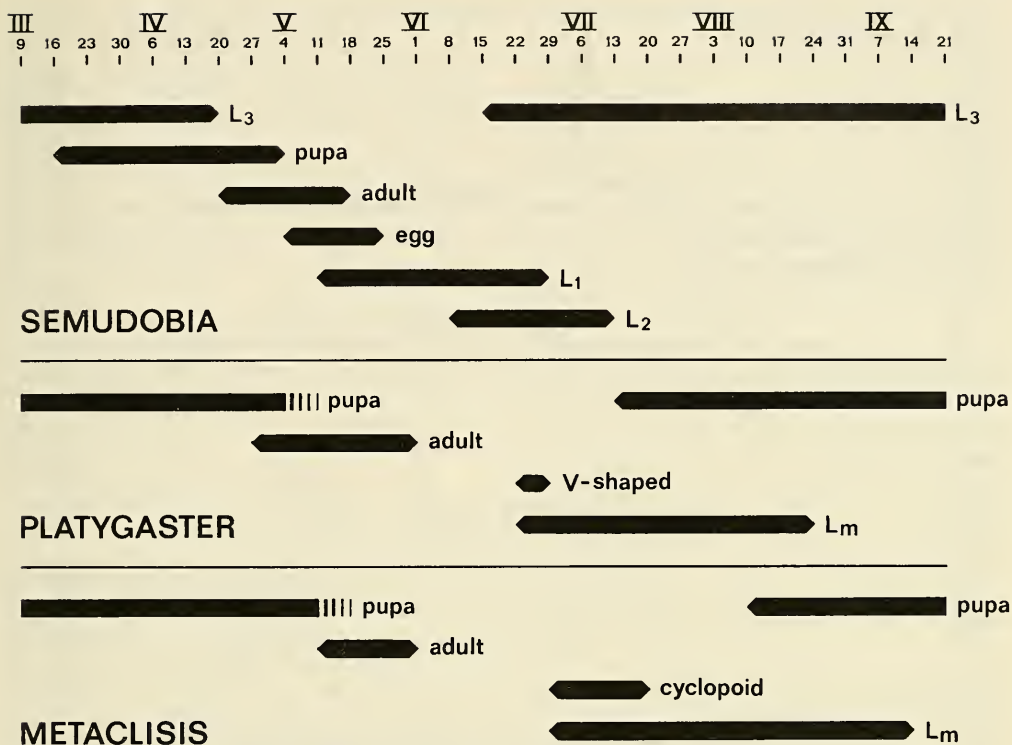

Fig. 42. Phenology of platygastroid parasitoids, Meijndel, 1972. L1, L2, L3, Lm: first, second, third, full grown larval instar, respectively.

females search for host eggs in absence of *Semudobia*. Adult parasitoid activity ceases when most of the host eggs have been eclosed in the last week of May. Parasitized gall midge embryo's apparently develop in a normal way. Hatched host larvae with dormant parasitoids mine into ovaries of *Betula* and induce galls as do healthy larvae. Not before the host reaches its early third instar, signs of parasitization appear. The host becomes less mobile and looses its bright orange colour. In this stage the V-shape "teratocyte stage" becomes apparent. From the end of June until mid-August the final instar larva fills about the whole body content of its host. From the end of July parasitoids pupate, remaining within the host skin and filling about half the room with meconium. In the second half of August the pupa is dark, fully sclerotized and looses its exuviae. The adult overwinters in a quiescent condition and leaves the gall when the temperature rises at the end of April of the following year.

*Metaclisis*. — This parasitoid is about a week later in development than *Platygaster*. The peri-

od of adult flight is somewhat shorter than that of both *Platygaster* species; it lasts only two to three weeks. Cyclopid larvae of *Metaclisis* become visible when the host is in its early third (final) instar, as does the V-shaped stage of *Platygaster*. The cyclopid stage, however, lasts considerably longer than the V-shaped one.

*Platygaster* and *Metaclisis* were present in all samples collected in North-Western Europe, Switzerland and Poland. *Platygaster* was also reared from samples collected in Wladiwostok, U.S.S.R. and Sapporo, Japan. The lack of *Metaclisis* in these samples may be attributed to small sample sizes. Parasitoids belonging to *Platygaster* and *Metaclisis* are absent from the Nearctic: over 70 samples collected in Canada (Alberta and Quebec) and U.S.A. (Pennsylvania, Ohio, Illinois, South Dakota, Montana, Wyoming and Colorado) contained abundant *Semudobia* galls, but were free from these parasitoids. The undescribed platygastroid endoparasitoid was dissected from galls induced by *S. brevipalpis* Roskam in fruit catkins of *Betula populifolia* Marsh. (Pennsylvania, Catskill formation, Long Pond,

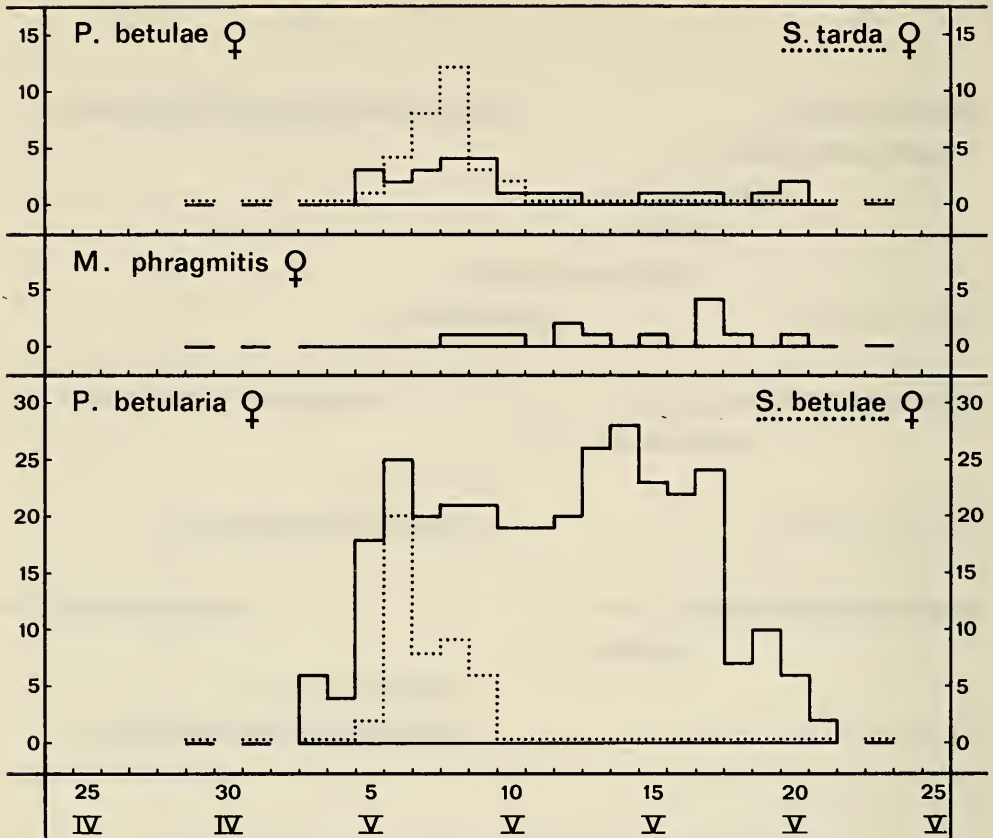

Fig. 43. Field captures of adult platygastid parasitoids, Meijndel, 1985. Drawn lines, parasitoid females; dotted lines, host females.

Luzerne County, Leg. A. A. Heller & E. Gertrude Halbach, 16—17.ix.1892). Not only egg-larval parasitoids, one sample with the undescribed form excepted, but also inquiline gall midges are absent from Nearctic samples (Roskam, 1979). Hence, Nearctic insect communities centered upon *Semudobia* are less diverse than Palaearctic ones: two complete segments of the food web, including important mortality factors in the Palaearctic, are missing in the Nearctic.

Endoparasitoids of *Dasineura*. — Two gall midge species, viz., *D. fastidiosa* Roskam and *D. interbractea* Roskam occur frequently in birch catkins. They are inquilines (food parasitoids) of *Semudobia* species (Roskam, 1979). Cyclopid stages of platygastid endoparasitoids (figs. 21, 22) were dissected from *Dasineura* larvae collected from 7.vi.—3.vii.1978, Meijndel, and on 20.vii.1977, Norway, Åseral. Because *Dasineura* larva drop onto the ground

before the parasitoids reach the full grown instar, this stage has not been observed and adults could not be reared.

In each parasitized *Dasineura* larva usually two parasitoids, attributed to *Piestopleura*, are present. The pairs of parasitoids are supposed to be twins as the result of polyembryonic development. A twinning development was earlier reported for another platygastid, namely, *Platygaster hiemalis* Förster (Leiby & Hill, 1923).

#### PARASITOID SPECIFICITY

In order to determine host — parasitoid specificity, adult parasitoids have been reared from sorted samples. The results are presented in table 5.

*Metacalis phragmitis*, although less common than both *Platygaster* species, is a regular parasitoid of *S. betulae* and *S. tarda*, but could only be reared once from *S. skubravae*. *Platygaster*



*betularia* is a common parasitoid of *S. skuhravae* and *S. betulae*, whereas *P. betulae* is only abundant on *S. tarda*. Because egg sizes of the various host species are different (Roskam, 1977), parasitoids might be able to discriminate between host eggs. Furthermore, host preference might also have a phenological basis, because small, but consistent differences exist between the phenologies of the host species (Roskam, 1977): *S. skuhravae* emerges first, followed by *S. betulae*; *S. tarda* is usually the latest. *Metaclisis* does not emerge before the second week of May; eggs of *S. skuhravae* may not be appropriate then anymore for oviposition of this parasitoid. For the same reason the phenologies of *P. betularia* and *S. tarda* may not match and, on the other hand, those of *P. betulae*, *S. skuhravae* and *S. betulae*.

Within the large genus *Platygaster*, *P. betulae* and *P. betularia* belong to different species groups, which Kieffer (1926) considered as different genera. This implies that the closest relatives of both species did develop on other hosts than *Semudobia*. Therefore, the ecological association between *Semudobia* and *Platygaster* did not affect their respective speciation patterns and a co-evolutionary process cannot be responsible for host- and egg-larval parasitoid diversity. This is probably in contrast with the speciation patterns of the food parasitoids, viz., *Dasineura interbracta* and *D. fastidiosa* (Roskam, 1979), and some of the chalcidoid parasitoids (Roskam, in preparation).

HOST MORTALITY

Host mortality has been determined by dis-

secting three samples of galls, collected in December, 1975 and 1983. The results are presented in table 6.

As a rule, mortality caused by *Metaclisis phragmitis* remains low; only in 1983, Meijndel, mortality of *Semudobia betulae* approached 10%. *Platygaster*, however, contributed considerably to gall midge mortality. In Duivenvoorde, 1975, and Meijndel, 1983, *P. betulae* alone caused a higher mortality than all chalcidoid parasitoids (about four species, belonging to three genera) together.

Densities (numbers of specimens per unit of area) of hosts and parasitoids may be interrelated. Whether density-dependent effects exist and how to determine these effects has been treated by Southwood (1978). Many reports on this subject have been discussed by Stubbs (1977). Southwood (1978, and references therein) supposed an exponential interdependence between the original density of host population  $N_t$  and the density of survivors  $N_s$  of a particular mortality factor according the function.

$$N_s = A(N_t)^B \tag{1}$$

where A and B are constants that define the relationships between mortality and density. In logarithmic form the equation is linear

$$\log N_s = \log A + B \log N_t \tag{2}$$

where B defines the slope of the regression line of  $\log N_s$  over  $N_t$ . When B does not depart significantly from 1, a density-dependent effect is absent. However, when  $B < 1$ , the mortality factor has a positive density-dependent effect: high host densities (aggregated situations) suffer proportionally more than low densities.  $B > 1$

Table 5. Parasitoid specificity regarding various *Semudobia* hosts.

AREA	YEAR	SEMUDOBIA SKUHRVAE										SEMUDOBIA BETULAE										SEMUDOBIA TARDA													
		HOST		<i>M. phragmitis</i>		<i>P. betulae</i>		<i>P. betularia</i>		CHALCIDOID PARASITIDS		TOTAL		HOST		<i>M. phragmitis</i>		<i>P. betulae</i>		<i>P. betularia</i>		CHALCIDOID PARASITIDS		TOTAL		HOST		<i>M. phragmitis</i>		<i>P. betulae</i>		<i>P. betularia</i>		CHALCIDOID PARASITIDS	
Hulehorst	1979	-	-	-	-	-	-	-	-	-	4	4	7	-	-	-	-	15	31	153	206	1	-	-	-	-	-	1	-	-	-	-	44	46	
Kootwijk	1979	2	-	-	-	-	-	-	2	7	11	8	-	2	-	-	-	1	9	69	89	-	-	-	-	-	-	-	-	-	-	2	2		
Meijndel	1977	146	-	1	-	-	12	7	134	300	156	13	17	-	-	21	57	213	477	101	44	32	71	80	-	3	148	479							
Meijndel	1979	13	-	-	1	1	22	59	19	115	43	1	3	-	-	15	46	303	411	93	3	8	17	60	1	5	140	327							
Duivenvoorde	1979	2	-	-	-	-	2	7	22	33	21	5	7	-	-	4	5	76	118	2	-	2	7	16	-	1	122	145							
IJperveld	1979	4	-	-	-	-	-	-	4	8	21	4	3	-	-	8	29	73	138	14	1	3	-	13	-	-	164	195							
Nieuwkoop	1979	-	-	-	-	-	-	4	107	111	38	11	11	-	-	26	116	186	398	6	1	2	2	13	-	-	110	134							
TOTAL		187	-	1	1	1	38	79	297	582	294	34	43	-	-	90	293	1073	1827	217	49	47	92	183	1	9	730	1328							

Table 6. Mortality (%) caused by parasitoids. —, not defined.

HOST	AREA	YEAR	NR. of GALLS	PLATYGASTER	METACLISIS	CHALCIDOIDS	INQUILINES
<i>S. skuhravae</i>							
	Duivenvoorde	1975	16	6.3	0	6.3	-
	Meijendel	1975	1	0	0	0	-
	Meijendel	1983	78	14.1	0	19.1	0
<i>S. betulae</i>							
	Duivenvoorde	1975	133	11.3	2.3	25.6	-
	Meijendel	1975	1019	12.9	0	46.0	-
	Meijendel	1983	231	9.1	9.5	26.8	10.4
<i>S. tarda</i>							
	Duivenvoorde	1975	534	24.3	2.6	7.3	-
	Meijendel	1975	399	6.3	1.5	28.1	-
	Meijendel	1983	894	22.7	3.8	19.2	18.5

represents the inverse situation: density dependence is negative, low host densities (segregated situations) become proportionally more severely attacked. The intercept of the regression line,  $\log A$ , is not further considered; the meaning of this constant is discussed by Hassell (1975).

In order to determine the density-dependent

effect of *Platygaster*, two samples of catkins (ten per tree) were collected in Meijendel, December 1982 and 1983. Because each catkin was considered a functional unit of area, a patch, the numbers of galls ( $N_i$ ) and of galls without *Platygaster* parasitation ( $N_s$ ) were defined per catkin. Interference between *Platygaster* and other parasitoids was not considered because chalcidoid

Table 7. Density-dependent host mortality. (★), significant,  $p < 0.05$ .

HOST	YEAR	MEAN NR. of GALLS per CATKIN	NR. of CATKINS with GALLS	NR. of CATKINS with PLATYGASTER	NR. of GALLS in EMPTY PATCHES	NR. of GALLS in LOCALIZED PATCHES	B-VALUE
<i>S. skuhravae</i>	1982	0.16	25	4	45	7	-
	1983	1.52	17	7	33	45	-
<i>S. betulae</i>	1982	1.01	77	25	184	148	1.13★
	1983	4.62	37	12	117	114	0.97
<i>S. tarda</i>	1982	1.52	69	40	145	357	1.05
	1983	17.88	43	29	48	846	1.12★

parasitoids either refuse host larvae with *Platygaster* parasitoids (adults), or perish on such hosts (larvae). Galls attacked by inquiline *Dasi-neura*, which indeed may contain parasitized *Semudobia* larvae, have not been considered too, because it appeared impossible to determine parasitization of such hosts.

Two aspects become distinct from an analysis of the results (table 7). First, gall midge densities vary considerably among different years. *S. skuhrauae*, as well as *S. tarda*, caused in 1983 a tenfold of the galls of the preceding year and *S. betulae* produced four times more. Large differences among generations of different years have also been found for other gall midge species and may occur commonly (Skuhrová et al., 1984). The mechanisms that cause such large fluctuations are not well understood.

Second, *Platygaster* species indeed have different effects upon different gall midge densities. Only about one third, or less, of catkins with galls in low densities (those of *S. skuhrauae* and *S. betulae*, 1982), but about two third of catkins with galls in high densities (*S. tarda*, 1983) contained parasitized gall midge larvae. This means that many low density patches remained unnoticed („not localized”) by ovipositing parasitoids and may therefore function as escape possibilities for the midges. In high density situations (*S. tarda*, 1983), almost all galls occur in catkins found by parasitoids. If B-values are defined for patches, visited by parasitoids, a rather surprising result emerges: either B does not significantly depart from 1 (*S. betu-*

*lae* — *P. betularia*, 1983; *S. tarda*—*P. betulae*, 1982), which means that the parasitoids are unable to regulate the host densities; or B is significantly larger than 1 (*S. betulae*—*P. betularia*, 1982; *S. tarda*—*P. betulae*, 1983; fig. 44), which means that in those cases the parasitoids have a negatively density-dependent impact on their hosts. Moderate (and, when localized, low) host densities suffer more than high ones. Hence, in localized catkins, escape possibilities for the midges are larger in patches with high densities.

Combining the outcome for localized and not localized catkins, the conclusion is that *Platygaster* parasitoids may be able to eliminate moderate host densities. Escape possibilities for the gall midges remain in both tails of their density distribution: in highly segregate, as well as in highly aggregate situations.

#### CONCLUSIONS

1. Adult *Platygaster betularia* and *P. betulae* can be distinguished by a combination of antennal characters; larvae by a combination of characters regarding the height of the tergal gland, the diameter of the stigma on the second thoracic segment and the length of the mandibles.

2. No discrimination is possible between subgroups of a parasitoid species that developed in different host species (e.g. *P. betularia* reared from *S. skuhrauae* or *S. betulae*).

3. All platygastriid egg-larval parasitoids develop highly synchronized with their hosts. *Metaclisis phragmitis* develops about one week later than both *Platygaster* species. This pheno-

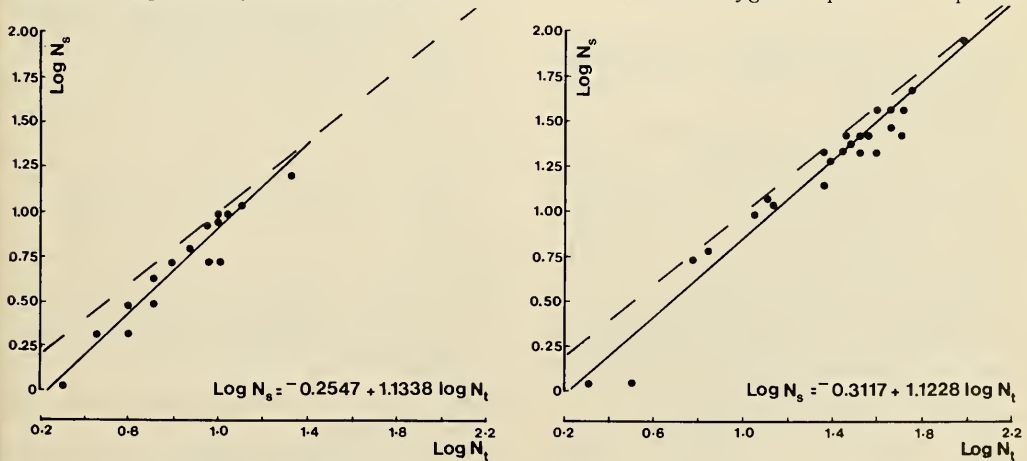

Fig. 44. Density-dependent host mortality. B, slope of the regression line; N<sub>s</sub>, density of survivors; N<sub>t</sub>, original density of host population. Drawn line, regression of N<sub>s</sub> over N<sub>t</sub>; dashed line B = 1. Left graph, *Platygaster betularia* on *Semudobia betulae*, Meijendel, 1982; right graph, *P. betulae* on *S. tarda*, Meijendel, 1983. For further explanation, see text.



logical difference might explain the absence of *Metaculis phragmitis* from *S. skubravae*.

4. *Platygaster* has been reared from Western and Eastern Palaearctic localities. *Platygaster* and *Metaculis* are absent from Nearctic *Semudobia* galls. One Nearctic collection of an unknown egg-larval parasitoid excepted, the whole guild of egg-larval parasitoids is absent from this region, as is the guild of inquilines.

5. Almost complete separation exists in the host preference of the two *Platygaster* species: *P. betularia* is a common parasitoid of *S. skubravae* and *S. betulae*, whereas *P. betulae* is common on *S. tarda*. *Metaculis phragmitis*, one collection excepted, has not been reared from *S. skubravae*.

6. Diversity of egg-larval parasitoids and their hosts is not a result of co-evolution, because *P. betularia* and *P. betulae* belong to different species groups, whereas *Semudobia* species are close relatives.

7. *Platygaster* species are important mortality factors of *Semudobia* species and may have a density-dependent impact on their hosts. Escape possibilities for *Semudobia* are largest in highly aggregate situations, as well as in highly segregate ones.

#### ACKNOWLEDGEMENTS

I thank Mr. H. J. Vlug, Wageningen, for confirming the identifications and for critical reading of a draft of this paper. Dr. M. Zandee, Leiden, provided the statistical advice and Mr. K. Jalink prepared the SEM photographs.

#### REFERENCES

Bachmaier, F., 1965. Die Insekten- und Milbenfauna der Zwergbirke. — Veröff. zool. St. Samml., Münch. 9: 55—158.  
 Barnes, H. F., 1951. Gall midges of economic importance. V. Trees: 270 pp. — London.  
 Bigelow, R. S., & C. Reimer, 1954. An application of the linear discriminant function to insect taxonomy. — Can. Ent. 86: 69—73.  
 Clausen, C. P., 1956. The egg-larval host relationship among the parasitic Hymenoptera. — Boll. Lab. Zool. Gen. Agr. Portici 23: 119—133.  
 Debauche, H. R., 1947. Scelionidae de la faune belge. — Bull. Annl. Soc. r. ent. Belg. 83: 255—285.  
 Fulmek, L., 1968. Parasitinsekten der Insektengallen Europas. — Beitr. Ent. 18: 719—952.  
 Hassell, M. P., 1975. Density-dependence in single-species populations. — J. Anim. Ecol. 44: 283—295.  
 Hill, C. C., & W. T. Emery, 1937. The biology of *Platygaster herrickii*, a parasite of the hessian fly. — J. Agric. Res. 55: 199—213.  
 Hodges, S., 1969. Gall midges (Diptera-Cecidomyiidae)

dae) and their parasites (Hymenoptera) living in female birch catkins. — Trans. Soc. Br. Ent. 18: 195—266.  
 Kieffer, J. J., 1916. Beitrag zur Kenntnis der Platygasterinae und ihrer Lebensweise. — Centralbl. f. Bakt. 46: 547—592.  
 Kieffer, J. J., 1926. Scelionidae. — Das Tierreich 48: 1—885.  
 Leiby, R. W., & C. C. Hill, 1923. The twinning and monembryonic development of *Platygaster hie-malis*, a parasite of the hessian fly. — J. Agric. Res. 25: 337—350.  
 Leiby, R. W., & C. C. Hill, 1924. The polyembryonic development of *Platygaster vernalis*. — J. Agric. Res. 28: 829—840.  
 Lubischew, A. A., 1962. On the use of discriminant functions in taxonomy. — Biometrics 18: 455—476.  
 Marchal, P., 1906. Recherches sur la biologie et le développement des Hyménoptères Parasites. II. Les Platygasteres. — Arch. Zool. Exp. Gén. (4<sup>e</sup> Sér.) 4: 485—640.  
 Pimentel, R. A., 1979. Morphometrics: 276 pp. — Dubuque, Iowa.  
 Roskam, J. C., 1977. Biosystematics of insects living in female birch catkins. I. Gall midges of the genus *Semudobia* Kieffer (Diptera, Cecidomyiidae). — Tijdschr. Ent. 120: 153—197.  
 Roskam, J. C., 1979. Biosystematics of insects living in female birch catkins. II. Inquiline and predaceous gall midges belonging to various genera. — Neth. J. Zool. 29: 283—351.  
 Roskam, J. C., 1982. Larval characters of some eurytomid species (Hymenoptera, Chalcidoidea). — Proc. Kon. Ned. Ak. Wet. (Ser. C) 85: 293—305.  
 Roskam, J. C., & G. A. van Uffelen, 1981. Biosystematics of insects living in female birch catkins. III. Plant-insect relation between white birches, *Betula* L., Section *Excelsae* (Koch) and gall midges of the genus *Semudobia* Kieffer (Diptera, Cecidomyiidae). — Neth. J. Zool. 31: 533—553.  
 Salt, G., 1968. The resistance of insect parasitoids to the defence reactions of their hosts. — Biol. Rev. 43: 200—232.  
 Silvestri, F., 1916. Contribuzioni alla conoscenza biologica degli Imenotteri Parasiti. V. Sviluppo del *Platygaster dryomyiae* Silv. (Fam. Proctotrupidae). — Boll. Lab. Zool. Gen. Agr. Portici 11: 299—326.  
 Skuhřavá, M., V. Skuhřavý, & J. W. Brewer, 1984. The distribution and long-term changes in population dynamics of gall midges on cereals in Europe (Cecidomyiidae, Diptera). — Cecid. Internationale 5: 1—5.  
 Southwood, T. R. E., 1978. Ecological methods: 524 pp. — London.  
 Stubbs, M., 1977. Density dependence in the life-cycles of animals and its importance to K- & r-strategies. — J. Anim. Ecol. 46: 677—688.  
 Vinson, S. B., & G. F. Iwantsch, 1980. Host regulation by insect parasitoids. — Quart. Rev. Biol. 55: 143—165.







QL  
461  
568  
Ent.

# TIJDSCHRIFT VOOR ENTOMOLOGIE

UITGEGEVEN DOOR

DE NEDERLANDSE ENTOMOLOGISCHE VERENIGING

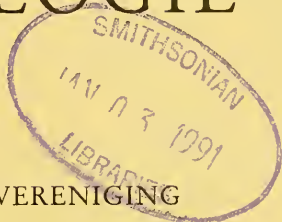

## INHOUD

M. R. DE JONG. — Taxonomy and biogeography of Oriental Prasiini. 2. The *foliata* group of the genus *Lembeja* Distant, 1892 (Homoptera, Tibicinidae), pp. 141—180, figs. 1—146.



# TAXONOMY AND BIOGEOGRAPHY OF ORIENTAL PRASIINI. 2. THE *FOLIATA* GROUP OF THE GENUS *LEMBEJA* DISTANT, 1892 (HOMOPTERA, TIBICINIDAE)

by

M. R. DE JONG

Zoölogisch Museum (Entomologie), University of Amsterdam, The Netherlands

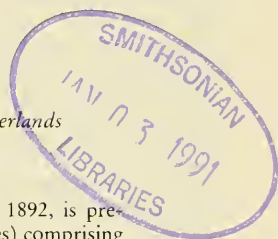

## ABSTRACT

A tentative concept for the *foliata* group of the genus *Lembeja* Distant, 1892, is presented. This group consists of two subgroups: the *foliata* subgroup (11 species) comprising *L. foliata* (Walker, 1858), *L. dekkeri* n.sp., *L. elongata* n.sp., *L. hollowayi* n.sp., *L. incisa* n.sp., *L. majuscula* n.sp., *L. minahassae* n.sp., *L. mirandae* n.sp., *L. oligorbanta* n.sp., *L. pectinulata* n.sp., all from Sulawesi, and *L. sangihensis* n.sp. from Sangihe island, about 200 km north of Manado (Sulawesi Utara), and the *distanti* subgroup (2 species) comprising *L. brendelli* n.sp. and *L. distanti* n.sp., both from Sulawesi. Some comments on characters and various character states, in connection with the supposed monophyletic status of the species-group, are given. All species are (re)described and structures of taxonomic importance as well as the whole insects are depicted. A key to all males and some females is presented.

## INTRODUCTION

The present study of the genus *Lembeja* Distant, 1892, is a further contribution to a revision of the Oriental Prasiini, started by De Jong and Duffels (1981) and continued by De Jong (1982, 1985).

Within the Oriental Prasiini, *Lembeja* is the most diversified and by far the most widespread genus. It is distributed over the Philippines (Mindanao), Sangihe island, Sulawesi, Lesser Sunda islands, New Guinea, Torres Strait islands and northern Queensland. The genus is tentatively divided in several species-groups by the present author on the basis of what are considered synapomorphic characters. These groups will be defined in this and forthcoming publications. Consequences for the taxonomy of the Oriental Prasiini as a whole will be discussed in a final paper, dealing with phylogenetic relationships of the *Lembeja* species-groups and the other taxa of the tribe.

One species-group and an assemblage of species have already been mentioned, though superficially, in previous publications, viz. the *faticilqua* group (see De Jong, 1985) and an assemblage of species similar to *Lembeja robusta* Distant, 1909 (see De Jong & Duffels, 1981; De Jong, 1982).

The group dealt with here, the *foliata* group, is distributed over Sulawesi and Sangihe island, 200 km north of Manado (Sulawesi Utara).

## HISTORY OF THE GENUS

*Lembeja* (originally described as *Perisoneura* Distant, 1883 (nom. preocc.)), was erected for *Lembeja maculosa* (Distant, 1883). Other species originally described in *Lembeja* or *Perisoneura* and not yet synonymized are *L. paradoxa* (Karsch, 1890) (see for synonymies De Jong, 1982), *L. fruhstorferi* Distant, 1897, *L. papuensis* Distant, 1897 (see for synonymies De Jong & Duffels, 1981), *L. sanguinolenta* Distant, 1909, *L. robusta* Distant, 1909, *L. roebli* Schmidt, 1925, and *L. harderi* Schmidt, 1925. The first species transferred to *Lembeja* is *Cephaloxys foliata* Walker, 1858 (see Distant, 1905). Stål had already referred this species to *Prasia* Stål, 1863 in 1862, thus erecting *Prasia* by indication (International Code of Zoological Nomenclature, 1985: Chapter iv, Article 12b 5). However, as it is common usage to regard *Prasia faticina* Stål, 1863, as the type-species of *Prasia*, the accepted concepts of *Prasia* and *Lembeja* would be at stake when the Rules would be followed strictly (see also De Jong, 1985). Other attributions are *Prasia fatiloqua* Stål, 1870 (see Horvath, 1913; Myers, 1928, 1929), *P. vitticollis* Ashton, 1912 (see De Jong, 1982) and *P. tincta* Distant, 1909 (see De Jong, 1985).

Since attributions of species to *Lembeja* or *Prasia* were often based upon obscure reasons, an attempt has been made recently (De Jong, 1985) to define characters that separate *Prasia*



from *Lembeja*, in addition to those presented with a new concept for *Prasia*.

#### INFRAGENERIC RELATIONSHIPS

In spite of the heterogeneity of *Lembeja* in its present concept, some distinctly separable species-groups can be recognized. One group has been mentioned above: the *fatioqua* group. Furthermore, an assemblage of species similar to *L. robusta* has been recognized.

The *fatioqua* group is characterized by a median longitudinal dentation of the male tergite 1, and the capability of males to inflate their bodies to a great extent, so that the large intersegmental membranes become visible. This feature is also displayed by the African genus *Iruana* Distant, 1905 (Boulard, 1976, 1981). Species attributed to the *fatioqua* group are *L. fatioqua*, *L. fruhstorferi*, *L. maculosa*, *L. paradoxa*, *L. roehli*, *L. sanguinolenta* and *L. tincta*.

The species similar to *L. robusta*, share a more or less strongly developed trilobate structure of the uncus in ventral view. Species attributed to this assemblage are, apart from some undescribed ones, *L. papuensis*, *L. robusta* and *L. vitticollis*.

A third group, the monophyletic *foliata* group, is defined here.

#### The *foliata* group

The *foliata* group is a monophyletic group, defined here by one presumed synapomorphy: the median longitudinal ridge on the male tergite 1 (fig. 32).

Tentatively, two subgroups are recognized, the *foliata* subgroup, comprising *L. dekkeri* n.sp., *L. elongata* n.sp., *L. foliata* (Walker, 1858), *L. hollowayi* n.sp., *L. incisa* n.sp., *L. majuscula* n.sp., *L. minabassae* n.sp., *L. mirandae* n.sp., *L. oligorhanta* n.sp., *L. pectinulata* n.sp. and *L. sangihensis* n.sp., and the *distanti* subgroup, with *L. brendelli* n.sp. and *L. distanti* n.sp. These two groups can be separated on account of different states of characters mainly found in the dorsal aedeagal appendage, the lateral part of the pygofer, the 3rd and 4th antennal segment and the ovipositor sheath. These differences are exemplified below.

The *foliata* subgroup is recorded from Sangihe island and North and Central Sulawesi, the *distanti* subgroup from Central and South-east Sulawesi. Neither of these subgroups have been found in South-west Sulawesi.

Some characters of the *foliata* group were studied in detail to investigate their significance for the reconstruction of a phylogeny of this species-group and of the Prasiini as a whole. These characters will be discussed here pending their eventual application in the classification of the Prasiini.

Base of dorsal aedeagal appendage. — In almost all species, the base of the dorsal aedeagal appendage is very broad and sturdy and nearly always sclerotized. In other genera and species-groups of the Oriental Prasiini the base is more narrow and usually not sclerotized.

Apex of dorsal aedeagal appendage. — The dorsal aedeagal appendage either bears two apical hook-shaped processes (*distanti* subgroup), or broadens towards the apex, which may be more or less incised (*foliata* subgroup). The appendage is absent in *L. pectinulata* n.sp. When present in other species of oriental Prasiini, the appendage is usually weakly sclerotized, and splits into two slender to broad processes of variable length.

Antennal combs. — Combs of hairs on the 3rd antennal segment (and usually onwards on the 4th segment) are hardly developed in the *distanti* subgroup and very distinct in almost all species of the *foliata* subgroup. The *foliata* group is the only one known within the Cicadoidea that displays this character.

Lateral pygofer lobe. — A flat enlargement of the lateral part of the pygofer in the *foliata* subgroup is situated between each of the edges running from the caudal dorsal beak to the lateral lobes, and a ridge-like structure running from the base of the lateral pygofer-lobe in posterior direction. This ridge is also more or less present in some species of the *fatioqua* group, where they do not form a flat enlargement as in the *foliata* subgroup. The species of the *distanti* subgroup have thick lateral lobes.

Spotting of tegmina. — This is usually red in the cells of the tegmina in the *foliata* subgroup, more brownish in the *distanti* subgroup. Pigmentation of the tegmina in other species of the Oriental Prasiini is still under study.

Mesostigma. — Large within the *foliata* group. Outside the *foliata* group this character is also found in *L. papuensis* and in two undescribed species from New Guinea.

Ovipositor sheath. — Long (sometimes very long) in the *foliata* subgroup and relatively short in the *distanti* subgroup, as in almost all

species of the Oriental Prasiini. A long ovipositor sheath is also found in *Jacatra typica* Distant, 1905, and, to an even greater extent, in an undescribed species of this genus from Jawa and Sumatera.

#### DEPOSITORIES

The abbreviations given below are used in the lists of material and throughout the text.

BIN	Koninklijk Belgisch Instituut voor Natuurwetenschappen, Brussel.
BMNH	British Museum (Natural History), London.
CNMW	Collection Naturhistorisches Museum, Wien.
DEI	Deutsches Entomologisches Institut, Eberswalde.
MHNG	Muséum d'Histoire Naturelle, Genève.
MSNG	Museo Civico di Storia Naturale "G. Doria", Genova.
MZB	Museum Zoologicum Bogoriense, Bogor.
RMNH	Rijksmuseum van Natuurlijke Historie, Leiden.
SMD	Staatliches Museum für Tierkunde, Dresden.
ZMA	Instituut voor Taxonomische Zoölogie, Zoölogisch Museum, Amsterdam.

#### ACKNOWLEDGEMENTS

I am very obliged to Dr J. P. Duffels, Dr P. Oosterbroek and Prof. Dr J. H. Stock for their critical reading of the manuscript.

The material studied was gratefully received from Mr R. Detry (BIN); Dr W. J. Knight, Mr M. D. Webb and Mr P. S. Broomfield (BMNH); Dr A. Kaltenbach c.s. (CNMW); Prof. Dr H. J. Müller, Dr G. Petersen and Dr A. Täger (DEI); Dr B. Hauser (MHNG); Dr R. Poggi (MSNG); Dr S. Adisoemarto (MZB); Dr P. H. van Doesburg (RMNH); Dr R. Emmrich (SMD). Most valuable material was gratefully received from the "Project Wallace" expedition and some of its participants, among which Dr H. S. Barlow, Mr M. J. D. Brendell, Dr J. P. Duffels, Dr T. W. Harman, Dr J. D. Holloway, Dr B. Pitkin, Dr G. Robinson, Dr J. van Stalle and Dr M. R. Wilson. This paper is based in part on material collected whilst the author was a participant on Project Wallace, sponsored by the Royal Entomological Society of London and the Indonesian Institute of Sciences (Results of Project Wallace No. 19).

I am indebted to Mr G. Verlaan and Mr J.

Zaagman for technical assistance, to Mr L. v. d. Laan for the photographs and to Dr W. N. Ellis for help with nomenclatorial problems.

The participation of Dr J. P. Duffels to the "Project Wallace" expedition was supported by the Netherlands Foundation for the Advancement of Tropical Research (WOTRO: WR85—197).

The present investigations were supported by the Foundation for Fundamental Biological Research (BION), which is subsidized by the Netherlands Organization for the Advancement of Pure Research (ZWO).

Part of the material from the Rijksmuseum van Natuurlijke Historie at Leiden (RMNH) mentioned in this publication will be deposited eventually in the Museum Zoologicum Bogoriense at Bogor (MZB).

#### TAXONOMY

A short characterization of the species-group as a whole is presented here, whilst some details of each subgroup will precede the descriptions of the species, included in the subgroup.

All methods of investigation follow De Jong (1985), with the exception of the measurements taken of the abdomen length (and consequently the body length) and the ovipositor sheath length of the females, which is exemplified in fig. 4.

The female genitalia have not been studied yet, since I intend to publish separately a paper dealing with the female genital characters of the Oriental Prasiini.

#### The *Lembeja foliata* group

Head triangular protruding in dorsal view. Antennal segment 1 clearly visible; segment 3 and 4 mostly provided with comb(s) of hairs.

Mesostigma large. Male opercula small, just extending over tymbal cavities.

Tegmina hirsute, always with small spots combined to somewhat larger patches along the veins in a regular pattern, and with small spots inside the tegmen areas. Third apical area 0.78—1.05 × as long as 4th apical area.  $Cu_2$  and  $A_1$  veins fused up to the tegmen border. Wing with anal field enclosed by a fusion of the  $Cu_2$  and  $A_1$  veins between 69—95% of their length.

Male abdomen carinate along tergites 3—7. Laterally tergites 3—8 strongly folded, forming a lateral ridge on each side of the sternites. Tergite 1 bulbous with two short lateroproximal flaps, each continued into a weakly sclerotized flap; medially a longitudinal ridge present, end-

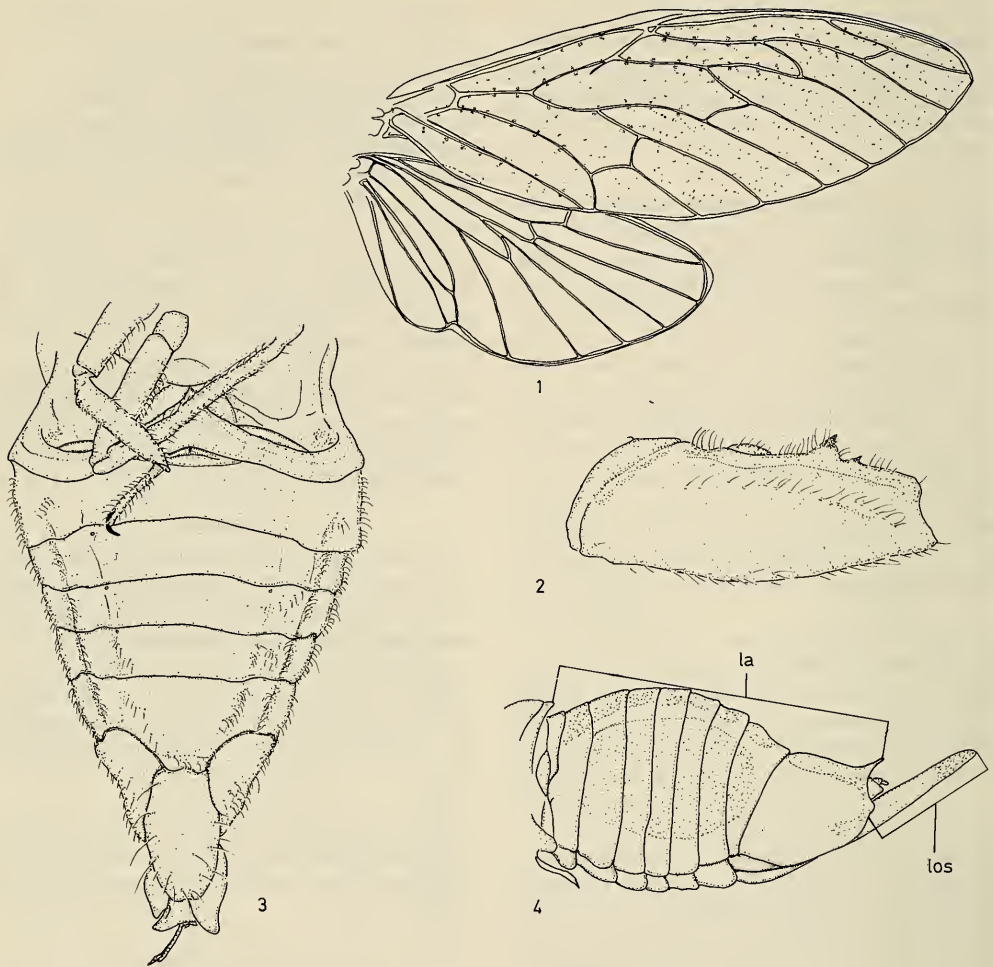

Figs. 1—4. Semischematic figures of the *L. foliata* group: 1, right tegmen and wing, *Lembeja elongata*; 2, female femur, lateral view, *L. elongata*; 3, male abdomen, ventral view, *L. elongata*; 4, female abdomen, lateral view, *L. majuscula* (la= length abdomen; los= length ovipositor sheath).

ing in a more or less triangular shaped bulb, often attached to tergite 2. Triangularly shaped sternite 1 small, blunt at apex. Folded membranes and mirrors medium-sized. Sternite 8 usually short; broad at base.

Tymbals with 14—23 long ridges, alternating with usually the same number of short ridges.

Female abdomen slender, carinate dorsally; in lateral view convex along tergites 3—8. Ovipositor sheath extending beyond caudal dorsal beak.

Lateral lobes of the pygofer fairly long, but mostly not extending beyond anal valves. Caudal dorsal beak broad and long. Claspers broad at base, tapering towards apex, which often has

a small apical protrusion. Median uncus part more or less pointed. Aedeagus fairly stout, dentate apex usually rounded. All species (except *L. pectinulata* n.sp.) provided with a more or less broadly attached dorsal aedeagal appendage.

Key to the species of the *foliata* group  
(species marked with an asterisk are keyed out for the males only)

1. Antennal segment 3 with distinct comb (sometimes also on segment 4) (fig. 23). ♂: tergite 1 distally not, or slightly, depressed on both sides of the triangular shaped bulb (fig. 22); dorsal aedeagal appendage, when



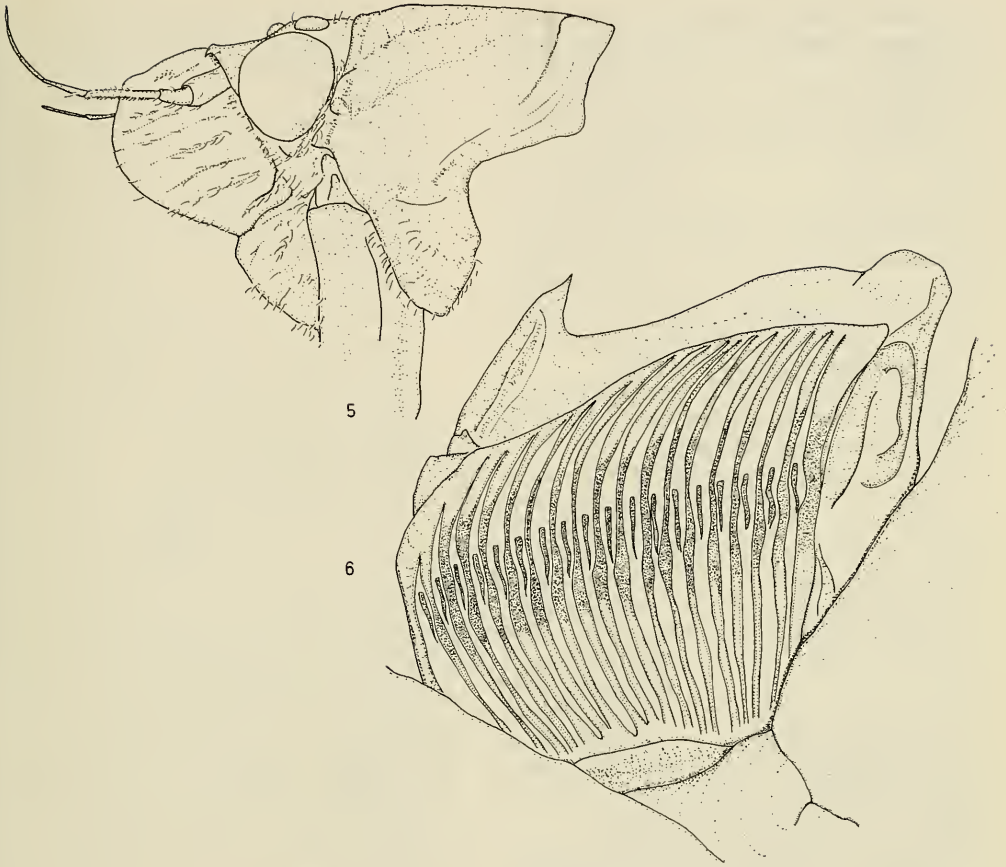

Figs. 5, 6. *L. foliata* group: 5, head and pronotum, lateral view, *Lembeja minahassae*; 6, left tymbal, lateral view, *L. mirandae*.

- present, unpaired, broad with sometimes slightly incised apex (fig. 9). ♀: ovipositor sheath relatively long (fig. 4) . . . . . *foliata* subgroup 2
- Antennal segment 3 without or with weakly developed comb. ♂: tergite 1 distally clearly depressed on both sides of the triangular bulb (fig. 127); dorsal aedeagal appendage with two hook-shaped processes (fig. 120). ♀: ovipositor sheath, though extending beyond caudal dorsal beak, relatively short . . . . . *distanti* subgroup 12
2. Tegmina more or less opaque, usually green . . . . . 3
- Tegmina (sub)hyaline, sometimes greenish or with large spots . . . . . 6
3. Tymbal with 19—22 long ridges . . . . . 4
- Tymbal with 14 long ridges, alternating with an equal number of short ridges. North Sulawesi . . . . . *foliata* (p. 149)\*
4. Medium-sized species (body length ♂: 18.3—22.7 mm, ♀: 19.1—22.4 mm). ♂: tymbal with 19—22 long ridges; base of weakly sclerotized dorsal aedeagal appendage relatively narrow, apex of appendage round or only slightly incised; apex of aedeagus with a more or less dorsal projection. ♀: abdomen rather sturdy; tegmina weakly opaque. Altitude ≥ 1000 m. North Sulawesi . . . . . 5
- Relatively small species (body length ♂: 14.8—17.5 mm, ♀: 19.1—20.8 mm). ♂: tymbal with 21 long ridges; dorsal aedeagal appendage weakly to fairly sclerotized and with a relatively sturdy base, apex medially incised; apex of aedeagus ovally shaped. ♀:

- abdomen rather slender; tegmina fairly opaque. Altitude  $\leq 800$  m. North Sulawesi . . . . . *minahassae* (p. 151)
5. Body length: 18.3—21.7 mm. Apex of aedeagus with a long dorsal projection. Altitude 1000—1200 m. North Sulawesi . . . . . *elongata* (p. 153)\*
- Body length: 21.1—22.7 mm. Apex of aedeagus without or with a short dorsal projection. Altitude ca. 1600 m. North Sulawesi . . . . . *dekkeri* (p. 155)\*
6. Tegmina (sub)hyaline (may be greenish tinged) with small red spots along the veins and inside the cells of the tegmen . . . . . 7
- Tegmina hyaline with medium-sized to large brown or dark-red spots inside the cells of the tegmen . . . . . 10
7. Dorsal aedeagal appendage absent; aedeagus with large tooter-shaped apex. North Sulawesi . . . . . *pectinulata* (p. 158)\*
- Dorsal aedeagal appendage present; apex of aedeagus different . . . . . 8
8. Body brownish coloured. Aedeagus broadened laterally at apex (fig. 58); clasper broad in lateral view. Sangihe island . . . . . *sangihensis* (p. 160)\*
- Body green to greenish-yellowish, sometimes with a brown patch on the cruciform elevation. Aedeagus not broadened laterally; clasper apically swollen in lateral view. North and Central Sulawesi . . . . . 9
9. Red spots inside cells and along veins on the whole of the tegmina. Small species (body length  $\delta$ : 13.4—15.5 mm,  $\eta$ : 14.6—16.8 mm).  $\delta$ : apex of dorsal aedeagal appendage as in fig. 67. North and Central Sulawesi . . . . . *hollowayi* (p. 162)
- Red spots only conspicuous along veins in basal part of tegmen, sometimes also slightly in apical part. Medium-sized species (body length  $\delta$ : 18.4 mm,  $\eta$ : 18.4—19.1 mm).  $\delta$ : apex of dorsal aedeagal appendage as in fig. 80. Central Sulawesi . . . . . *oligorhanta* (p. 164)
10. Small, heavily pigmented species with hardly any spots inside the cells of the tegmen. Body size  $\delta$ : 14.2—15 mm,  $\eta$ : 15.1—16.7 mm. Central Sulawesi . . . . . *incisa* (p. 171)
- Large, heavily pigmented species with more or less brown spotted cells of the tegmen. Body size  $\delta$ : 22.8—25.5 mm,  $\eta$ : 20.4—21.6 mm. Central Sulawesi . . . . . 11
11. Tegmina heavily spotted with brown in the cells of the tegmen.  $\delta$ : median black spots on the carinated tergites 3—7; dark coloration onwards to the caudal dorsal beak; apex of aedeagal appendage as in fig. 98.  $\eta$ : caudal dorsal beak dark coloured. Central Sulawesi . . . . . *majuscula* (p. 170)
- Tegmina less heavily spotted with brown in the cells of the tegmen.  $\delta$ : black spots on the carinated tergites 3—7 absent; apex of aedeagal appendage as in fig. 91.  $\eta$ : medio-dorsal black coloration on segment 9 not reaching the caudal dorsal beak. Central Sulawesi . . . . . *mirandae* (p. 166)
12. Antennal comb on segment 3 may be present. Distance between lateral ocelli 0.83—0.97  $\times$  distance lateral ocellus and eye.  $\delta$ : pygofer without distinct ridge from the base of each lateral lobe downwards. Central and South-East Sulawesi . . . . . *distanti* (p. 175)
- Antennal comb on segment 3 when present, only very slightly. Distance between lateral ocelli 1.0—1.6  $\times$  distance lateral ocellus and eye.  $\delta$ : distinct ridge on the pygofer from base of each lateral lobe downwards. Central Sulawesi . . . . . *brendelli* (p. 178)

The material studied contains several unidentified females of the *foliata* group that probably represent undescribed species, of which no males have been found. Three large females (body length: 23.5—24.5 mm) from Sangihe island (BMNH; RMNH) and four smaller females (body length: 16.5—17.4 mm) from Morowali (Sulawesi Tengah) (BMNH) represent two species of the *foliata* subgroup with opaque tegmina. Three small females (body length: 15.2—17.3 mm) from Morowali (BMNH) represent one species with (sub)hyaline tegmina of the same subgroup. One female (body length: 20.2 mm) from Mt. Tambusisi (Morowali N.P.) (BMNH) represents a species that has brown and/or dark-red spots in the cells of the tegmina, and still belonging to the same subgroup. Finally, one female (body length: 24.7 mm) from Mt. Tambusisi (Morowali N.P.) (BMNH) represents a species belonging to the *distanti* subgroup.

#### The *foliata* subgroup

The *foliata* subgroup is characterized by the presence of distinct combs on the 3rd, and sometimes 4th, antennal segment. Eyes small, width 0.43—0.67  $\times$  as wide as width of vertex between eyes. Tegmina opaque or (sub)hyaline. Spots on the tegmina always red, deep-red to brown in *L. majuscula* n.sp., *L. mirandae* n.sp. and *L. incisa* n.sp. Aedeagal appendage (lacking in *L. pectinulata* n.sp.) usually sclerotized and



Map 1. Distributions of *L. brendelli*, *L. dekkeri*, *L. distanti*, *L. elongata*, *L. foliata* and *L. minahassae*.



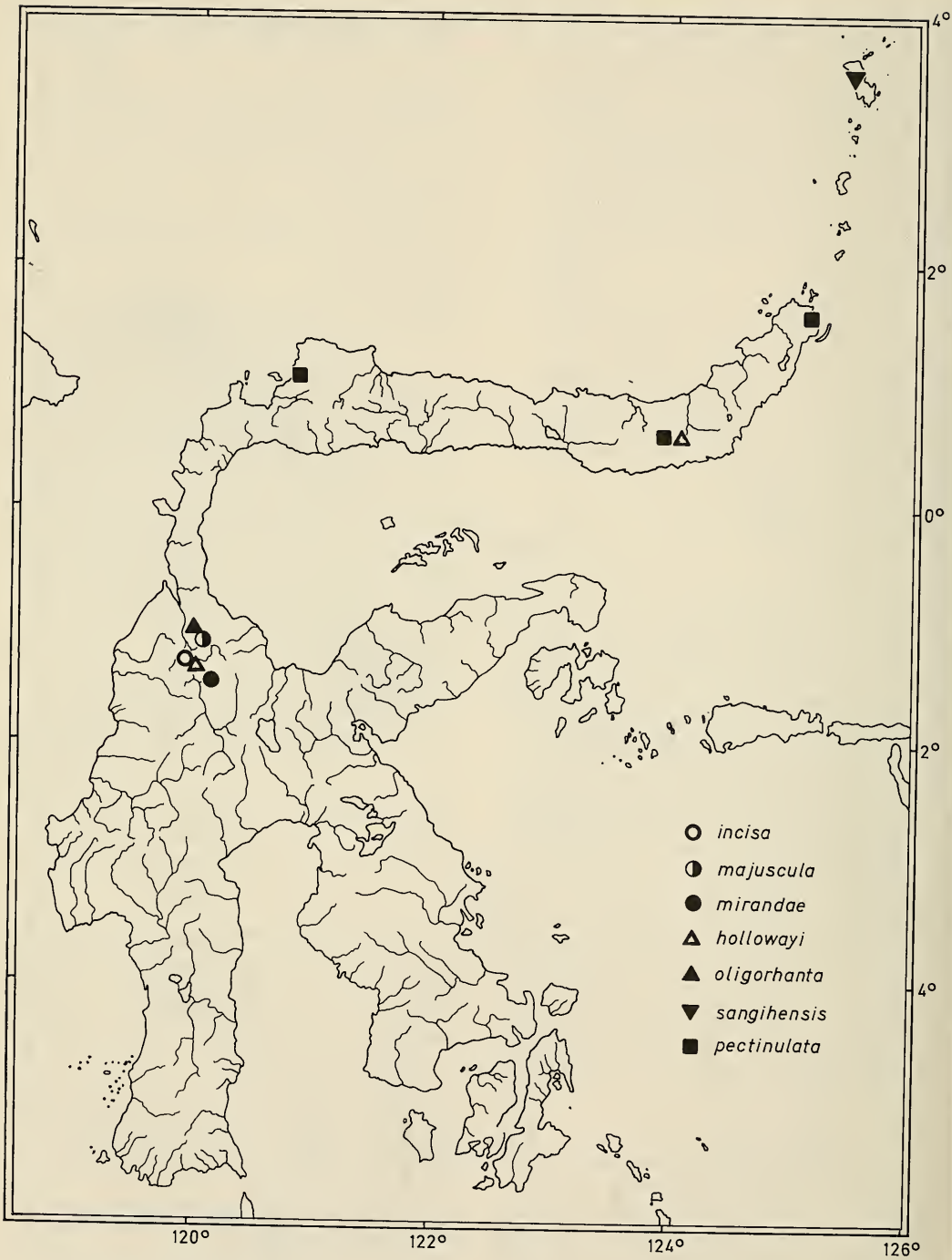

Map 2. Distributions of *L. hollowayi*, *L. incisa*, *L. majuscula*, *L. mirandae*, *L. oligorhanta*, *L. pectinulata* and *L. sangihensis*.

slightly incised at its broad apex. Lateral part of pygofer provided with a flat enlargement between the edge of the caudal dorsal beak, running to each lateral lobe, and the ridge running backwards from the base of each lateral lobe. Lateral lobe somewhat recurved at its apex (fig. 20). Median uncus part with a smooth, pointed projection. Ovipositor sheath extending relatively far beyond caudal dorsal beak.

***Lembeja foliata*** (Walker, 1858)  
(figs. 7—14, map 1)

*Cephaloxys foliata* Walker, 1858: 37.

*Prasia foliata*; Stål, 1862: 483; Distant, 1892: xiv (in partim: specimens from Sulawesi (= Celebes) only): 146: pl. 15 figs. 12, 12a—b (equals *Cephaloxys foliata* Walk.); Breddin, 1901: 28.

*Lembeja foliata*; Distant, 1906: 185 (equals *Prasia foliata* equals *Cephaloxys foliata*); Kato, 1932: 189; Metcalf, 1963: 430, 431; De Jong, 1985: 165, 166.

The following references were found to relate to other species:

*Prasia foliata*; Distant, 1892: xiv (in partim: specimens from Sangihe island belong to *Lembeja sangihensis* n.sp.); Breddin, 1901: 153 (specimens from Sangihe belong to *Lembeja sangihensis* n.sp.); Lallemand, 1935: 677 (Flores specimens belong to a yet undescribed species related to *L. harderi*).

*Lembeja foliata*; Lallemand and Synave, 1953: 233 (Flores specimens belong to a yet undescribed species related to *L. harderi*; Sumba specimens belong to *L. harderi* and to a yet undescribed relative to this species).

My knowledge of the species is based on two specimens only, viz. the male holotype, whose genitalia are damaged, and a male from an unknown locality in bad condition, but its genitalia fairly intact (only the apex of the caudal dorsal beak missing).

**Description of the male.**

Body testaceous. Head and pronotum together 1.14—1.34 × as long as meso- and metanotum together. Thorax and head together 1.09 × as long as abdomen. Greatest width of body at the height of abdominal segment 3.

Head.—Postclypeus strongly protruding in dorsal view. Antennal combs on 3rd and 4th segments. Eye small, in dorsal view 0.43—0.49 × as wide as width of vertex in between eyes. Ocelli raised. Distance between lateral ocelli 0.9—1.2 × as long as distance between lateral ocellus and eye. Head 1.54—1.82 × as long, 1.85—1.98 × as wide as width of vertex in be-

tween eyes. Postclypeus in ventral view strongly laterally compressed, in lateral view transverse ridges distinct, concolorous. Rostrum with dark apex reaching trochanter of middle leg.

Thorax.—Pronotum collar 1.61 × as wide as head including eyes, 1.75 × as wide as length of head. Pronotum weakly domed. Mesonotum dark on its lateral parts and in front of cruciform elevation, thus indicating four obconical areas. Length of cruciform elevation about 1/3 of mesonotum length. Metanotum projecting distinctly from under mesonotum.

Legs.—Concolorous, fore femora bearing three spines. Basal one very long and pointed apically; middle spine triangularly shaped, about half as long as basal one; most apical spine very small. Fore tibiae with a brown patch apically.

Tegmina and wings.—Costa of tegmen very finely hirsute. Subhyaline, testaceous. Spotted with red along veins in a very regular pattern, small red punctations inside tegmen cells. Transverse vein of 2nd ulnar area extending into 3rd one; continued by a fold, up to the fusion of the  $Cu_{1b}$  and the transverse vein of the 8th apical area. Node in  $M_{3+4}$  at about 3/5 of its length. Third ulnar area 1.09 × as long as 1st ulnar area; 4th ulnar area 0.97 × as long as radial area. Wings pale hyaline. Veins milky white coloured.  $A_1$  and  $Cu_2$  fused at 75% of their own length.

Operculum.—Distal part of operculum very small. Meracanthus large, reaching more than halfway over tymbal cavity.

Abdomen.—Broadly shaped. Medial ridge on tergite 1 ending in a triangularly shaped bulb, broadly attached to tergite 2. Folded membrane dark coloured.

Tymbals.—Relatively large, 14 long ridges alternating with an equal number of short ridges.

Genitalia.—Pygofer with a medium-sized, apically rounded, broad caudal dorsal beak. Lateral lobes long, but not extending beyond anal valves, somewhat concave at outside, convex at inside. Edge running downwards from lateral lobe to base of pygofer slightly rounded. Median part of uncus small, weakly pointed. In lateral view claspers broad, apically tapering, with a small nail-shaped protrusion; median part narrow in dorsal view. Aedeagus with apex as in fig. 11, dentate. Flat dorsal aedeagal appendage medio-apically weakly sclerotized, broadening towards its apex, consisting of

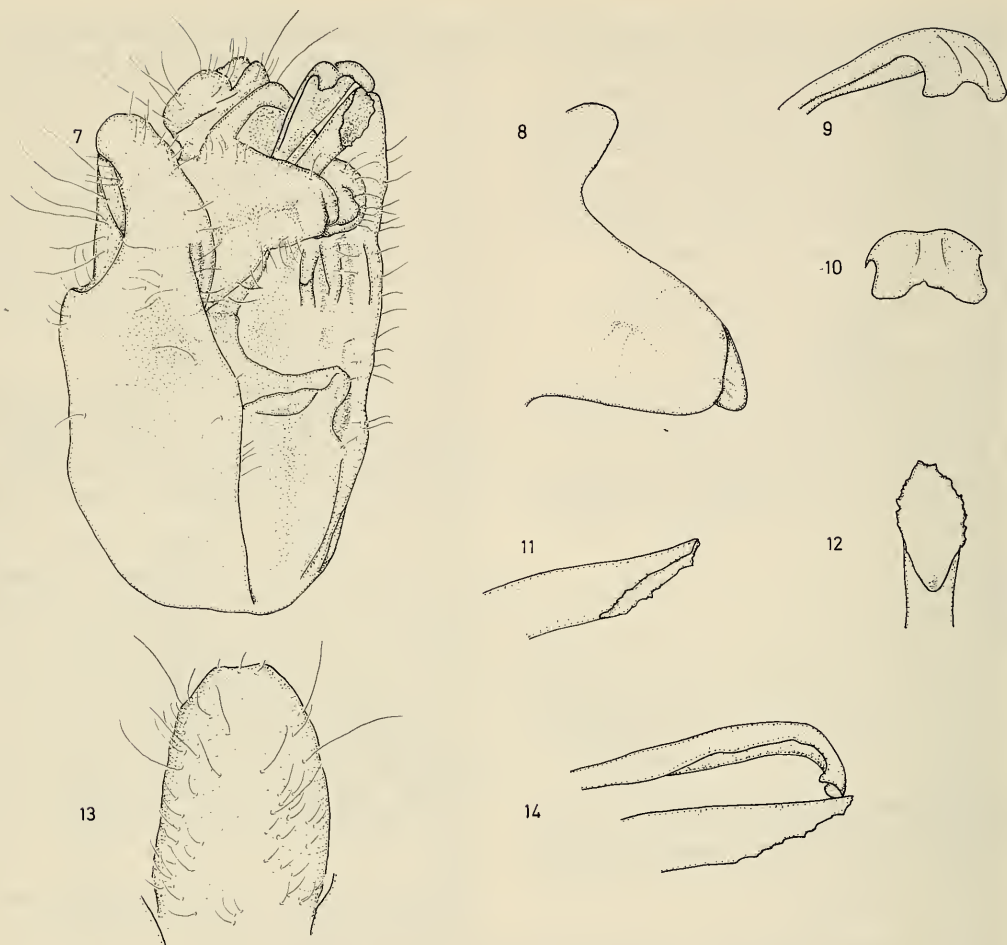

Figs. 7—14. *Lembeja foliata*, unknown locality. 7, pygofer, ventrolateral view; 8, clasper, lateral view; 9, aedeagal appendage ventrolateral view; 10, apex of aedeagal appendage, ventral view; 11, 12, apex of aedeagus, 11, ventrolateral view, 12, ventral view; 13, sternite 8, ventral view; 14, apex of aedeagus with appendage, lateral view.

a medial incision and reaching apex of aedeagus.

Measurements of the material studied: body length 17.8 mm; width of pronotum collar 5.7 mm; tegmen length 22.1—23.2 mm.

Distribution. — North Sulawesi: Manado (map 1).

Material examined. — Indonesia, Sulawesi: Manado “Celebes” (with on leaf-over)<sup>55/22</sup> (round label, handwritten; according to the acquisition books of the BMNH “<sup>55/22</sup>” stands for Manado), “Prasia” (handwritten), “*Cephaloxys foliata*” (with on leaf-over) “gineis, tibiis tarsisque/areolis margin alibus fus” (print), “Type” (round label, green edged, print), “Brit. Mus”

(print), ♂ holotype of *Cephaloxys foliata* (BMNH). Specimen without locality: 1 ♂ (RMNH).

#### Remarks.

*L. foliata* closely resembles *L. minabassae* n.sp., *L. elongata* n.sp. and *L. dekkeri* n.sp. in the opaque tegmina and the clasper which is fairly broad in lateral view. Some females in the material studied may be attributed to *L. foliata*, but the identification is uncertain so that they remain unidentified. As far as known the species was not collected during the “Project Wallace” Expedition in the Dumoga-Bone N.P. (Sulawesi Utara). It is distinct for its relatively low num-



ber of alternating pairs of ridges on the tymbal and its apex of the dorsal aedeagal appendage.

**Lembeja minahassae** n.sp.

(figs. 15—25, 139, 140, map 1)

The description of this new species is based upon specimens collected during the "Project Wallace" Expedition in the Dumoga-Bone N.P. (Sulawesi Utara), primarily by Dr J. P. Duffels (ZMA) and Dr J. D. Holloway (Commonwealth Institute of Entomology). The species is described in comparison with *L. foliata*.

**Description.**

Coloration of most males studied suggesting immaturity. Smaller than *L. foliata*, yellowish green coloured. Head and pronotum 0.98—1.2 × as long as meso- and metanotum together. Thorax and head together in males 0.72—0.88 ×, in females 0.83—0.89 × as long as abdomen. Greatest width of body at the height of abdominal segment 3.

Head. — Yellowish green. Antennal combs as in *L. foliata*. Eye small to medium-sized in dorsal view, 0.46—0.6 × as wide as width of vertex in between eyes. Ocelli raised. Distance between lateral ocelli in males 0.82—1.0 ×, in females 1.08—1.28 × distance between lateral ocellus and eye. Head 1.53—1.74 × as long, 1.92—2.2 × as wide as vertex width between eyes. Postclypeus ventrally green. Rostrum as in *L. foliata*.

Thorax. — Pronotum collar 1.55—1.97 × as wide as width of head, 1.94—2.29 × as wide as length of head. Four, green to yellow, obconical areas indicated by patches; median obconical areas being less than half as long as paramedian ones, the latter reaching cruciform elevation. Hind edge of cruciform elevation somewhat darker coloured. Metanotum as in *L. foliata*.

Legs. — Spines on fore femora as in *L. foliata*. Fore femora darker green than remaining part of legs. All legs darkening towards claws.

Tegmina and wings. — Tegmina opaque green (more conspicuous in females), extreme base milky white. Costa somewhat amplified. Spotting similar to *L. foliata*. Veins yellowish green to green. Third ulnar area 0.93—1.16 × as long as 1st one; 4th ulnar area 0.85—1.0 × as long as radial area. Transverse vein and corial fold as in *L. foliata*. Wings milky, fusion of  $Cu_2$  and  $A_1$  at 72—83% of their length.

Male: Operculum. — Small. Meracanthus broad at base, long and pointed, extending well over tymbal cavity.

Abdomen. — Yellowish green coloured. Generally as in *L. foliata*, but distally more slender. Folded membrane white.

Tymbals. — Twenty-one long ridges alternating with an equal number of short, slightly brownish coloured ridges.

Genitalia. — Generally as in *L. foliata*. Lateral lobes rather swollen. Median part of uncus slender and somewhat more pointed. Edge of pygofer just below each lateral lobe more outcurved than in *L. foliata*. Weakly sclerotized apex of dorsal aedeagal appendage incised; just reaching apex of aedeagus.

Female: Operculum. — Small and rounded. Meracanthus reaching just over sternite 3.

Abdomen. — Yellowish green coloured. Slender, slightly carinate in lateral view. Ovipositor sheath 0.36—0.51 × length of abdomen.

Measurements of the types: body length ♂: 14.8—17.5 mm,  $\bar{x}$  = 16.7 ± 1.0 mm, ♀: 19.1—20.8,  $\bar{x}$  = 19.9 ± 0.5 mm; width of pronotum collar ♂: 4.8—5.4 mm,  $\bar{x}$  = 5.1 ± 0.2 mm, ♀: 5.9—6.6 mm,  $\bar{x}$  = 6.3 ± 0.2 mm; tegmen length ♂: 19.4—21.5 mm,  $\bar{x}$  = 20.2 ± 0.8 mm, ♀: 22.9—24.8 mm,  $\bar{x}$  = 23.8 ± 0.7 mm.

Distribution. — North Sulawesi (map 1).

Types. — Indonesia, Sulawesi: Holotype: "Stat. 16/Lowland rainforest/light-trap, site 1+2/understorey/canopy" (print), "Toraut/7—13.ii.1985/H. S. Barlow" (print), "Indonesia/Sulawesi Utara/Dumoga-Bone N.P./Project Wallace" (print), 1 ♂ (MZB). Paratypes: Sulawesi Utara, Dumoga-Bone N.P.: st. 9, lowl. rainf., MV light-trap, Page (= Barney's) Camp 302 m, 4—8.ii.1985, J. P. Duffels & J. D. Holloway, 1 ♂ (ZMA); st. 15, lowl. rainf., understorey/canopy, MV light-trap, Hog's Back Camp 492 m, 12—13.ii.1985, J. P. Duffels & J. D. Holloway, 1 ♀ (MZB), 1 ♀ (ZMA); same data as holotype, 1 ♀ (MZB); st. 24, lowl. rainf., light-trap site 1, understorey, Toraut, 23—26.ii.1985, H. S. Barlow, 1 ♀ (MZB), 1 ♂ 1 ♀ (ZMA); st. 27, lowl. rainf., MV light-trap, understorey/canopy, Edwards Camp 664 m, 20.ii.1985, J. P. Duffels & J. D. Holloway, 1 ♀ (MZB), 1 ♀ (ZMA); Edwards Camp, iv.1985, J. H. Martin, 1 ♂ (BMNH); Kosingolan, guest-house P.P.A. headquarters, at lighth, 13.iv.1985, Charlotte Vermeulen, 1 ♀ (ZMA); Toraut, Rothamsted light-trap, site 1, 200 m, v.1985, 1 ♂ 1 ♀ (BMNH); surroundings Tumpah River, iii.1985, J. H. Martin, 1 ♀ (BMNH).

Etymology. — The species is named after its distributional area, the Minahassa Peninsula (Sulawesi Utara).

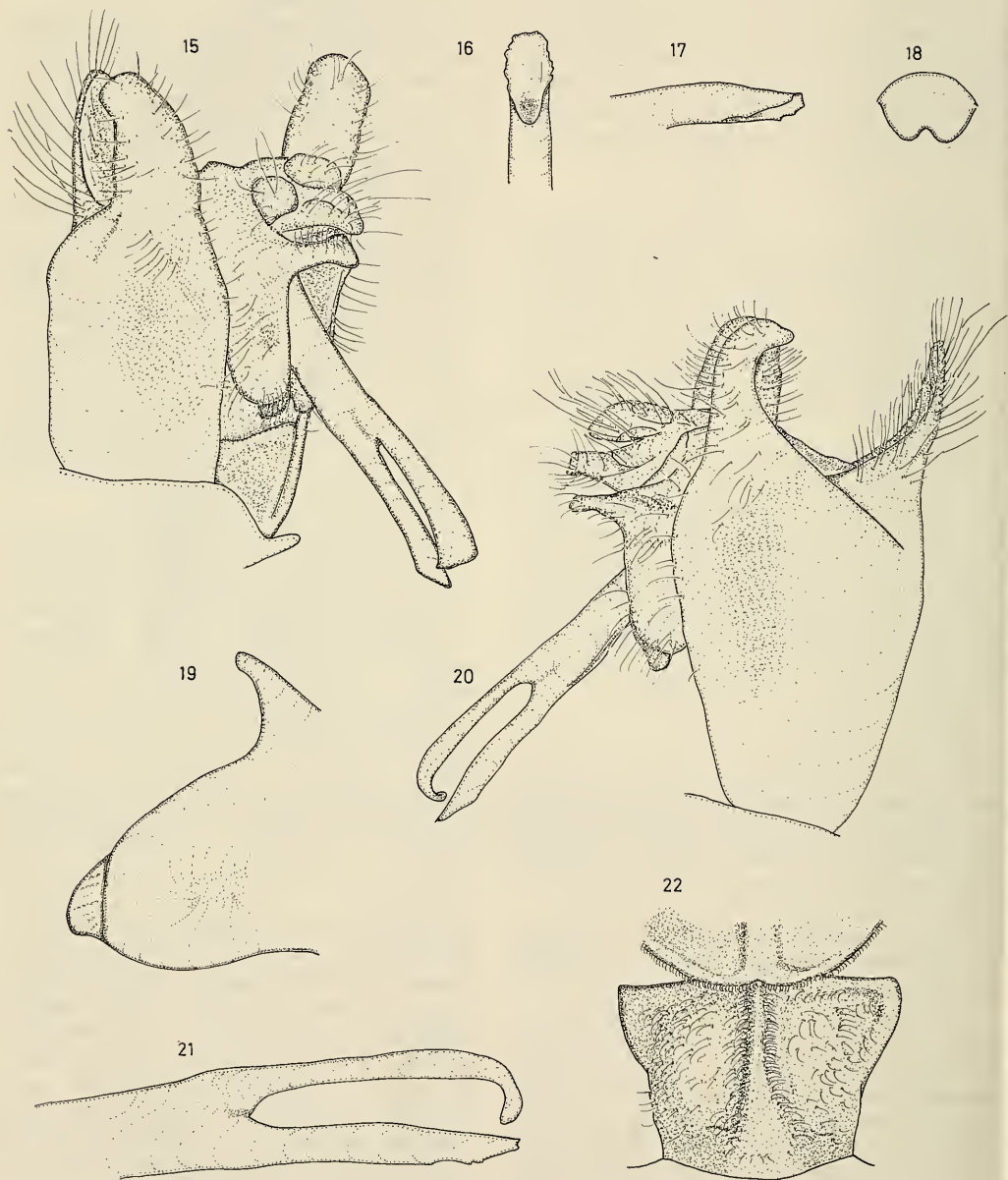

Figs. 15—22. *Lembeja minahassae*, ♂. 15, pygofer, ventrolateral view, paratype Toraut; 16, 17, apex of aedeagus, paratype Toraut, 16, ventral view, 17, ventrolateral view; 18, apex of aedeagal appendage, ventral view, paratype Toraut; 19, clasper, lateral view, paratype Toraut; 20, pygofer, lateral view, paratype Toraut; 21, aedeagus with appendage, lateral view, paratype Toraut; 22, tergite 1, dorsal view, paratype Hog's Back Camp.

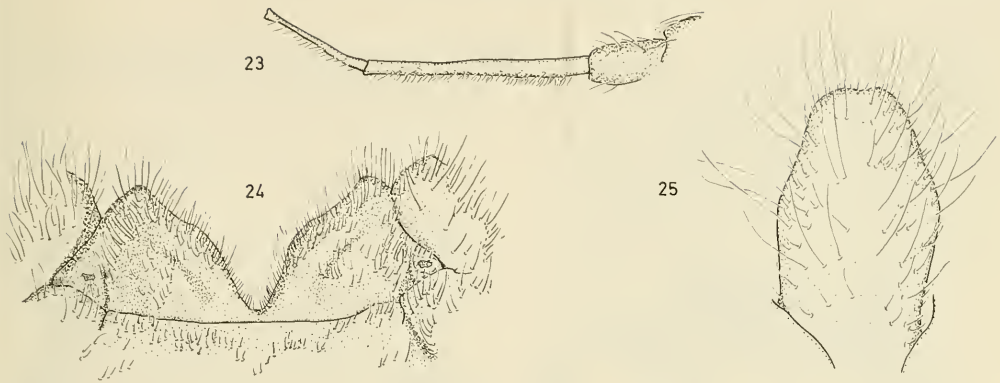

Figs. 23—25. *Lembeja minabassae*; 23, 25, ♂, paratype Toraut; 24, ♀, paratype Hog's Back Camp. 23, left antenna segm. 1—4, lateral view; 24, sternite 7, ventral view; 25, sternite 8, ventral view.

#### Remarks.

*L. minabassae* is very much alike the somewhat larger *L. foliata* but can be distinguished by the number of ridges but on the tymbal, details in the genitalia and the distally more slender male abdomen.

#### *Lembeja elongata* n.sp. (figs. 26—35, map 1)

The species is described in comparison with *L. foliata* and *L. minabassae* after a series of specimens collected during the "Project Wallace" Expedition in the Dumoga-Bone N.P. (Sulawesi Utara). Relative sizes are based upon 10 male and 10 female type-specimens.

#### Description.

Somewhat larger than *L. foliata*, greenish abdomen may be more slender distally. Tegmina opaque. Head and thorax greenish. Head and pronotum together  $1.0\text{--}1.21\times$  as long as meso- and metanotum together. Head and thorax together in males  $0.73\text{--}0.82\times$ , in females  $0.74\text{--}1.0\times$  as long as abdomen. Greatest width of body at the height of abdominal segment 3.

Head. — Generally as in *L. foliata*, though with somewhat larger eyes, each being  $0.52\text{--}0.67\times$  as wide as width of vertex in between eyes. Half of antennal segment 2 and onwards to apex of antennae dark coloured, combs on segments 3 and 4 not as dense as in *L. minabassae*. Distance between lateral ocelli  $0.78\text{--}1.37\times$  distance between lateral ocellus and eye. Head  $1.52\text{--}1.79\times$  as long as,  $2.04\text{--}2.36\times$  as wide as width of vertex in between eyes. Transverse ridges unicolorous.

Thorax. — Pronotum collar  $1.56\text{--}1.80\times$  as wide as width of head including eyes,  $2.01\text{--}2.45\times$  as wide as length of head. Four obconical areas clearly recognizable by light coloured patches, filled with some dark spots. Sometimes double-axed shaped dark-coloured mark on mesonotum. Sometimes dark median spot on cruciform elevation.

Legs. — As in *L. foliata*. All legs slightly darkening towards apex.

Tegmina and wings. — Tegmina only slightly greenish opaque, extreme base white with a slight red infuscation. Transverse vein of 2nd ulnar area just extending into the 3rd one. Third ulnar area  $0.85\text{--}1.23\times$  as long as 1st one; 4th ulnar area  $0.89\text{--}1.10\times$  as long as radial area. Veins of the wing whitish or greenish tinged.  $Cu_2$  and  $A_1$  fused at  $69\text{--}83\%$  from their origin.

Male: Operculum. — Compared to *L. foliata* only a little larger. Meracanthus as in *L. foliata*.

Abdomen. — Generally shaped as in *L. minabassae*. Folded membrane only slightly brownish tinged. Triangular shaped bulb on tergite 1 more narrowly attached. Proximal edge of tergite 1 sturdy and sometimes whitish coloured.

Tymbals. — Twenty-two long ridges alternating with an equal number of short ridges.

Genitalia. — Generally as in *L. foliata*. Lateral lobes of pygofer much more erect. Edge of lateral lobe running straightly downwards to base of pygofer. Claspers long and broad. Apex of aedeagus dorsally elongated by a slender, pointed projection. Dorsal aedeagal appendage weakly sclerotized, slightly incised at its round apex.



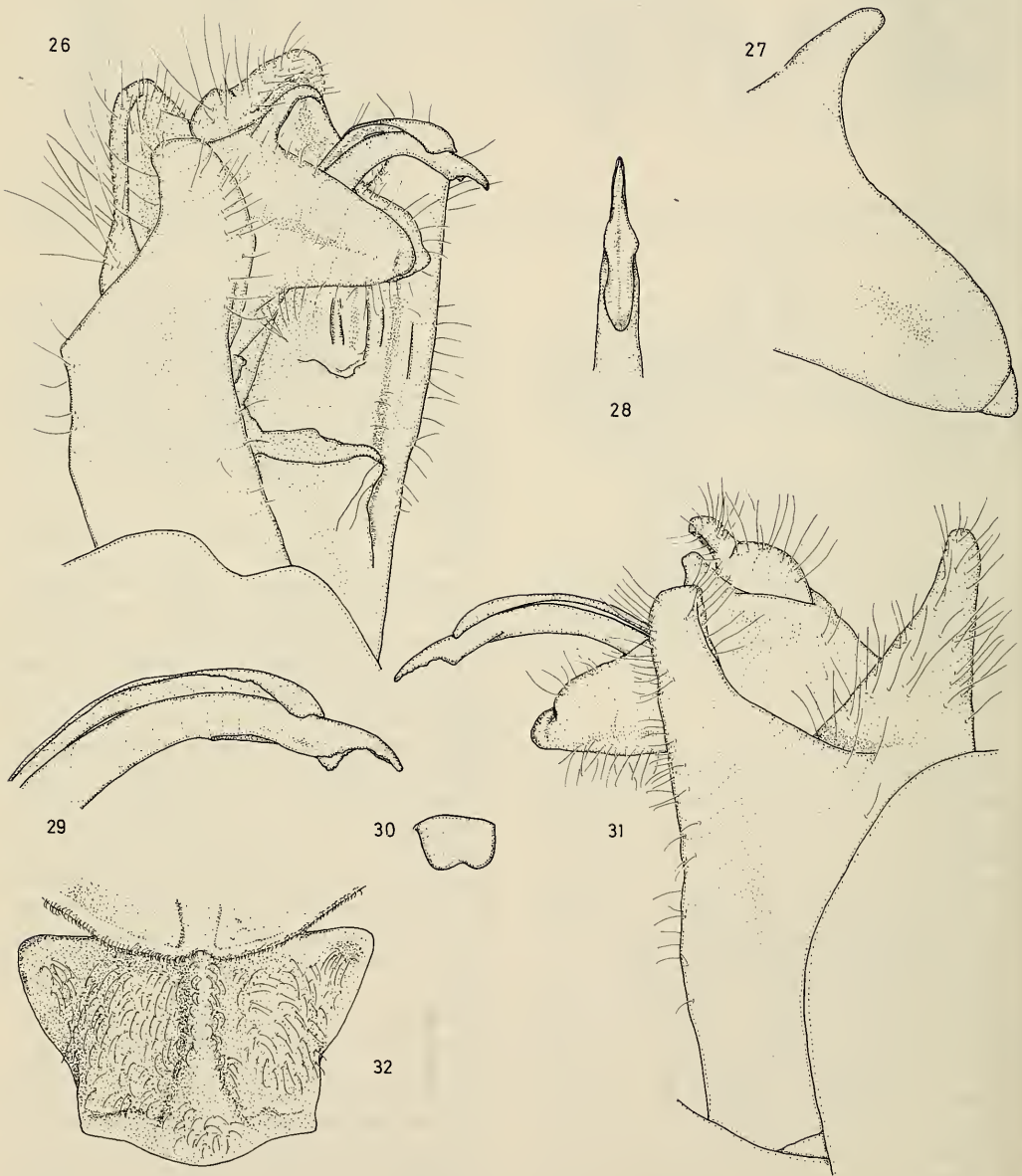

Figs. 26—32. *Lembeja elongata*, holotype. 26, pygofer, ventrolateral view; 27, clasper, lateral view; 30, apex of aedeagal appendage, ventral view; 31, pygofer, lateral view; 32, tergite 1, dorsal view.

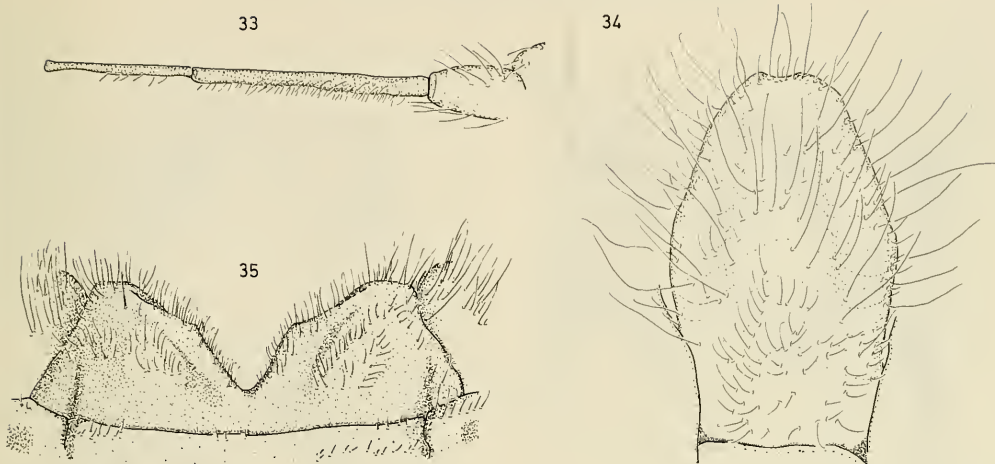

Figs. 33–35. *Lembeja elongata*; 33, 34, ♂, holotype; 35, ♀, paratype Clarke's Camp. 33, left antenna segm. 1–4, lateral view; 34, sternite 8, ventral view; 35, sternite 7, ventral view.

Female: Operculum. — Small. Meracanthus reaching over sternite 3.

Abdomen. — Slender, carinate. Ovipositor sheath 0.43–0.53 × as long as abdomen.

Measurements of the types: body length ♂: 18.3–21.7 mm,  $\bar{x}$  = 19.5 ± 0.9 mm, ♀: 19.1–22.2 mm,  $\bar{x}$  = 20.7 ± 0.8 mm; width of pronotum collar ♂: 5.5–6.6 mm,  $\bar{x}$  = 6.0 ± 0.3 mm, ♀: 6.2–7.5 mm,  $\bar{x}$  = 6.8 ± 0.3 mm; tegmen length ♂: 21.4–24.2 mm,  $\bar{x}$  = 22.7 ± 0.8 mm, ♀: 24.2–27.3 mm,  $\bar{x}$  = 25.3 ± 0.8 mm.

Distribution. — North Sulawesi (map 1).

Types. — Indonesia, Sulawesi: Holotype: "Stat. 19/Gardens/PPA rest-house/at light" (print), "Danau Moat/E of Kotamobagu/1200 m/18.ii.1985/J. P. Duffels" (partly handwritten, partly print; correct height: 1080 m), "Indonesia/Sulawesi Utara/Project Wallace" (print), 1 ♂ (MZB). Paratypes: Sulawesi Utara: Danau Moat, 22–25.iii.1985, 1 ♂ (BMNH), same locality, 20–22.x.1985, G. Robinson, 1 ♂ (ZMA); Dumoga-Bone N.P., Clarke's Camp (= "1440"), 1140 m, lightsheet, iii. 1985, J. H. Martin, 1 ♂ (BMNH), same data but: iv.1985, 2 ♂ (BMNH), v.1985, 1 ♂ 8 ♀ (BMNH), same locality but: 25.iii.1985, T. W. Harman, 1 ♂ 1 ♀ (MZB), 19–25.iii.1985, M. Allen, 1 ♀ (MZB), same locality but: 13–14.x.1985, B. Pitkin, 1 ♂ (MZB), 1 ♂ 2 ♀ (ZMA); Gunung Ambang, near Danau Moat, iv.1985, J. H. Martin, 3 ♂ (BMNH), same locality but: 11.xi.1986, M. J. D. Brendell, 3 ♂ 3 ♀ (ZMA); Gunung Mogogonipa, 1008 m, lightsheet, 20–22.v.1985, J. H.

Martin, 1 ♂ 1 ♀ (BMNH), same locality but with, 12.vi.1985, lightsheet, M. R. Wilson, 1 ♂ (BMNH), same locality but with, 18–20.x.1985, K. Tuck, 1 ♂ 1 ♀ (MZB), 2 ♂ 1 ♀ (ZMA).

Etyymology. — The species is named after its elongated apex of the aedeagus.

Remarks.

*L. elongata* is very distinct by its typical apex of the aedeagus. The species is recorded only from an altitude of 1000–1200 m. It is very similar to the somewhat larger *L. dekkeri* n.sp. from which it can be distinguished only by characters of the male genitalia. They are probably confined to different altitudes.

***Lembeja dekkeri* n.sp.**  
(figs. 36–45, map 1)

This relatively large species (body length: 21.1–22.7 mm) is described after four male and two female specimens; the description has been made in comparison with that of *L. elongata*.

Description.

Green, relatively hairy, large species. Head and pronotum together 0.98–1.08 × as long as meso- and metanotum together. Head and thorax together in males 0.70–0.76 ×, in females 0.86 × as long as abdomen. Greatest width of body at the height of abdominal segment 3.

Head. — Antennae from 2nd segment to apex dark-coloured, 4th segment with a weakly de-

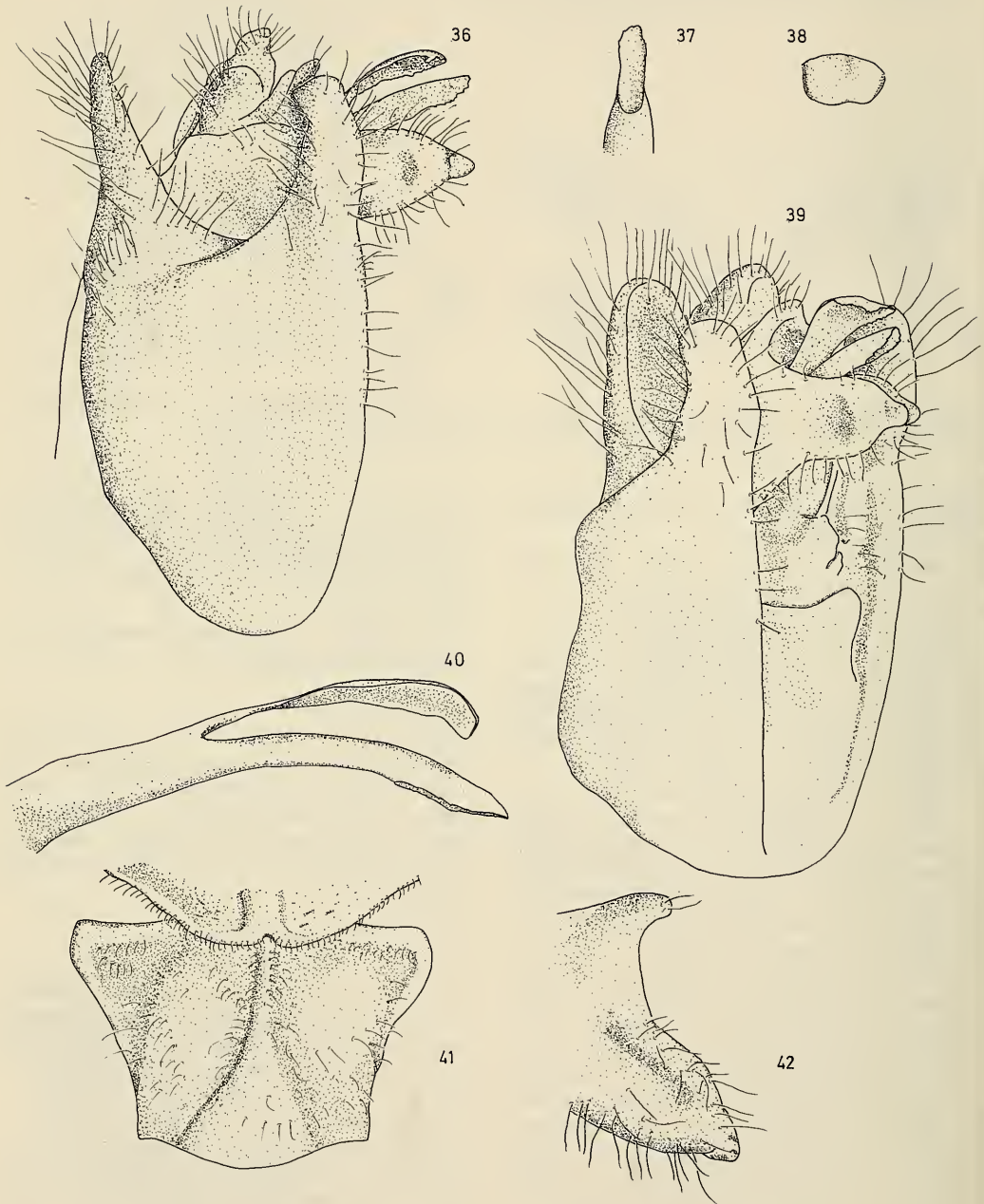

Figs. 36—42. *Lembeja dekkeri*. 36, pygofer, lateral view, paratype; 37, apex of aedeagus, ventral view, paratype; 38, apex of aedeagal appendage, ventral view, holotype; 39, pygofer, ventrolateral view, paratype; 40, aedeagus with appendage, lateral view, holotype; 41, tergite 1, dorsal view, holotype; 42, clasper, lateral view, paratype.



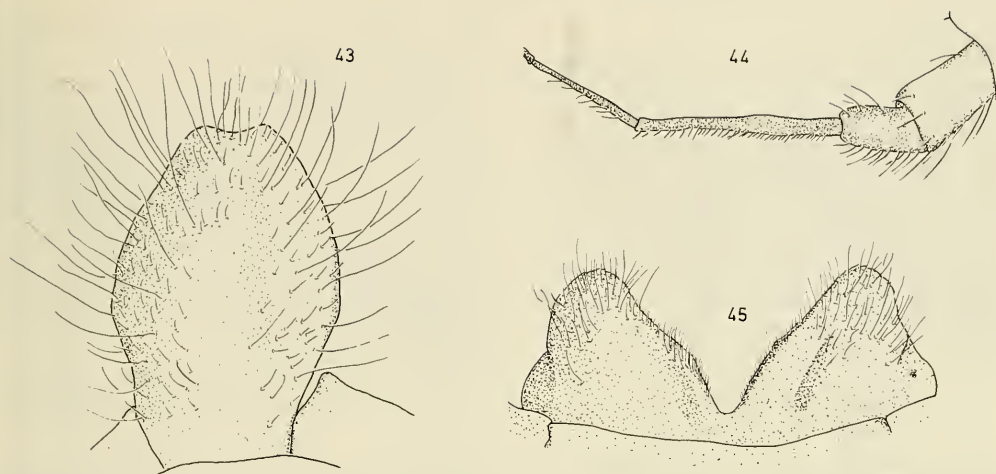

Figs. 43—45. *Lembeja dekkeri*; 43, 44, ♂; 45, ♀, paratype. 43, sternite 8, ventral view, holotype; 44, left antenna segm. 1—4, lateral view, paratype; 45, sternite 7, ventral view.

veloped comb. Eyes  $0.56\text{--}0.62 \times$  as wide as width of vertex between eyes. Distance between lateral ocelli  $0.98\text{--}1.20 \times$  distance between lateral ocellus and eye. Head  $1.50\text{--}1.72 \times$  as long as,  $2.12\text{--}2.24 \times$  as wide as width of vertex in between eyes. Transverse ridges of postclypeus concolorous. Rostrum with dark apex reaching trochanter of middle leg.

Thorax. — Pronotum collar  $1.67\text{--}1.84 \times$  as wide as width of head including eyes,  $2.26\text{--}2.64 \times$  as wide as length of head. Four obconical areas on mesonotum slightly recognizable. Paratype with a black-coloured mark covering the two small median obconical areas.

Legs. — Legs darker coloured towards claws. Tibiae and pretarsi with apical dark patches.

Tegmina and wings. — Tegmina greenish opaque. Extreme base whitish with a slight red infuscation. Transverse vein of 2nd ulnar area extending just into 3rd ulnar area; continued by a distinct fold. Third ulnar area  $1.03\text{--}1.20 \times$  as long as 1st one; 4th ulnar area  $0.84\text{--}1.04 \times$  as long as radial area. Veins of the wings whitish and greenish tinged. Fusion of the  $Cu_2$  and  $A_1$  at  $85\text{--}91\%$  of their length.

Male: Operculum. — Very small. Meracanthus reaching halfway over tymbal cavity.

Abdomen. — Large, light-greenish coloured. Tergite 1 as in *L. elongata*. Folded membranous white. Sternite 8 broad and distally rounded, only slightly incised.

Tymbals. — Nineteen to 22 long greyish

brown ridges alternating with 19—21 short orange brown ridges.

Genitalia. — Generally as in *L. elongata*. Mainly differing in the more pointed median part of uncus, the apex of the aedeagus not being prolonged, and the relatively larger dorsal aedeagal appendage.

Female: Operculum. — Small. Meracanthus reaching over sternite 3.

Abdomen. — Generally as in *L. elongata*. Ovipositor sheath  $0.39 \times$  as long as abdomen.

Measurements of the types: body length ♂:  $21.1\text{--}22.7$  mm, ♀:  $21.7\text{--}22.4$  mm; width of pronotum collar ♂:  $5.9\text{--}6.7$  mm, ♀:  $7.4\text{--}7.8$  mm; tegmen length ♂:  $23.3\text{--}24.8$  mm, ♀:  $26.2\text{--}27.6$  mm.

Distribution. — North Sulawesi (map 1).

Types. — Indonesia, Sulawesi: Holotype: "stat.20/lower montane/rainforest/MV light" (print), "Ice Station Zebra/Gn. Poniki-trail,  $\pm 1520$  m/23.x.1985/M. R. de Jong & M. J. D. Brendell" (print), "Indonesia:/Sulawesi Utara/Dumoga-Bone N.P./Project Wallace" (print) 1 ♂ (ZMA). Paratype: Sulawesi Utara: Dumoga-Bone N.P., stat. 19, lower montane rainforest, Ice Station Zebra, Gn. Poniki-trail,  $\pm 1570$  m, 23.x.1985, R. W. R. J. Dekker, 1 ♂ (MZB), same locality but: 3.xi.1985, station: 081, R. Bosman & J. van Stalle, 2 ♂ 2 ♀ (BIN).

Etymology. — The species is named after Mr René Dekker, who captured the first specimen, after it flew against his throat.

## Remarks.

There is an apparent correlation between body length, especially in the males, and altitude among *L. minabassae*, *L. elongata*, and *L. dekeri*. Within this small set of closely related species, which all are recorded from a different altitude, the species recorded from the lowest altitude (*L. minabassae*) is the smallest, while the one recorded from the highest altitude (*L. dekeri*) is the largest. Other small sets of species within the *foliata* group appear to show the same correlation (see also remarks on *L. oligorantha* n. sp. and *L. incisa* n. sp.).

***Lembeja pectinulata* n.sp.**

(figs. 46—55, map 2)

This small species is described after four males and three females.

## Description.

Body pale brownish yellow (fresh specimens green, ventrally a little paler; one female in the material studied is deep chocolate-brown, including the tegmina and wings, which is probably an artifact). Head and pronotum together 1.03—1.19 × as long as meso- and metanotum together. Thorax and head together in males 0.79 ×, in females 0.87—1.19 × as large as abdomen. Greatest width of body at the height of abdominal segment 3. It is the only species of the *L. foliata* group missing a dorsal aedeagal appendage.

Head. — Antennae dark from segment 2 to apex and with combs on segment 3. Eye small, in dorsal view 0.48—0.55 × as wide as vertex width in between eyes. Ocelli slightly raised, distance between lateral ocelli 0.96—1.30 × distance between lateral ocellus and eye. Head 1.50—1.59 × as long as, 1.97—2.10 × as wide as width of vertex in between eyes. Transverse ridges of postclypeus distinct in lateral view, concolorous. Rostrum with dark apex reaching trochanter of middle legs.

Thorax. — Pronotum collar 1.56—1.70 × as wide as width of head including eyes, 1.94—2.35 × as wide as length of head. Four pale obconical spots can hardly be discerned on the mesonotum; specimen from Tangkoko with large double-axe shaped, brown mark situated medially.

Legs. — Concolorous with underside of thorax. Fore femora bearing three spines: basal one longest and blunt, middle and distal small spines both acutely pointed. Fore tibiae with a brown

patch apically, and a somewhat paler brown patch at 1/3 of its length.

Tegmina and wings. — Tegmina subhyaline to slightly greenish opaque; spotted with red along veins and inside cells of the tegmen (basically as in *L. foliata*). Venation whitish, extreme base white, costa milky. Transverse vein of 2nd ulnar area just extending into the 3rd one; continued by a fold. Node halfway  $M_{3+4}$ . Third ulnar area 0.93—1.0 × as long as 1st one; 4th ulnar area 0.94—1.0 × as long as radial area. Wings pale-hyaline, fusion of  $Cu_2$  and  $A_1$  at 85—91% of their length.

Male: Operculum. — Extremely small and narrow. Meracanthus reaching over tymbal cavity.

Abdomen. — Medial ridge of tergite 1 ends distally in a small triangular bulb. Two lateral sclerotized flaps of tergite 1 not acutely pointed. Sternite 8 very short and broadly rounded.

Tymbals. — Twenty-three long ridges alternating with short brown ridges.

Genitalia. — Caudal dorsal beak relatively short and broadly rounded. Lateral lobes of pygofer fairly short, apical part of edge running straight downwards from lateral lobe to base of pygofer. Claspers in lateral view straight and narrow, nail-shaped protrusion relatively large. Median uncus part small and pointed medially. Aedeagus with large, tooter-shaped, apex (figs. 48—50), toothed along its edge.

Female: Operculum. — Small, more or less sickle-shaped. Meracanthus reaching sternite 3.

Abdomen. — Slender, carinate. Ovipositor sheath 0.39—0.46 × as long as abdomen.

Measurements of the types: body length ♂: 15.4—16.1 mm, ♀: 14.4—16.0 mm; width of pronotum collar ♂: 4.3—4.5 mm, ♀: 4.9—5.5 mm; tegmen length ♂: 17.1—19.3 mm, ♀: 19.6—20.1 mm.

Distribution. — North Sulawesi (map 2).

Types. — Indonesia, Sulawesi: Holotype: "Nord Celebes/Toli-Toli/Nov.—Dez. 1895/H. Fruhstorfer" (print), "*Lembeja*/n.sp." (handwritten), "Coll. A. Jacobi/1911—5" (print, yellow label), "Staatl. Museum für Tierkunde Dresden" (print), 1 ♂ (SMD). Paratypes: Sulawesi Utara: Dumoga-Bone N.P., Tumpah River, predated by jumping spider, 27.ix.1985, R. Wiles, 1 ♂ (ZMA); Percy, Tangkoko N.P., at light, 2—3.xi.1985, M. J. D. Brendell, 1 ♂ (ZMA); Toli-Toli, xi—xii.1895, H. Fruhstorfer, *Lembeja fruhstorferi*, 1 ♀ (BIN), same data but: Distant coll. 1911—353, 1 ♀ (BMNH), *Lembe-*

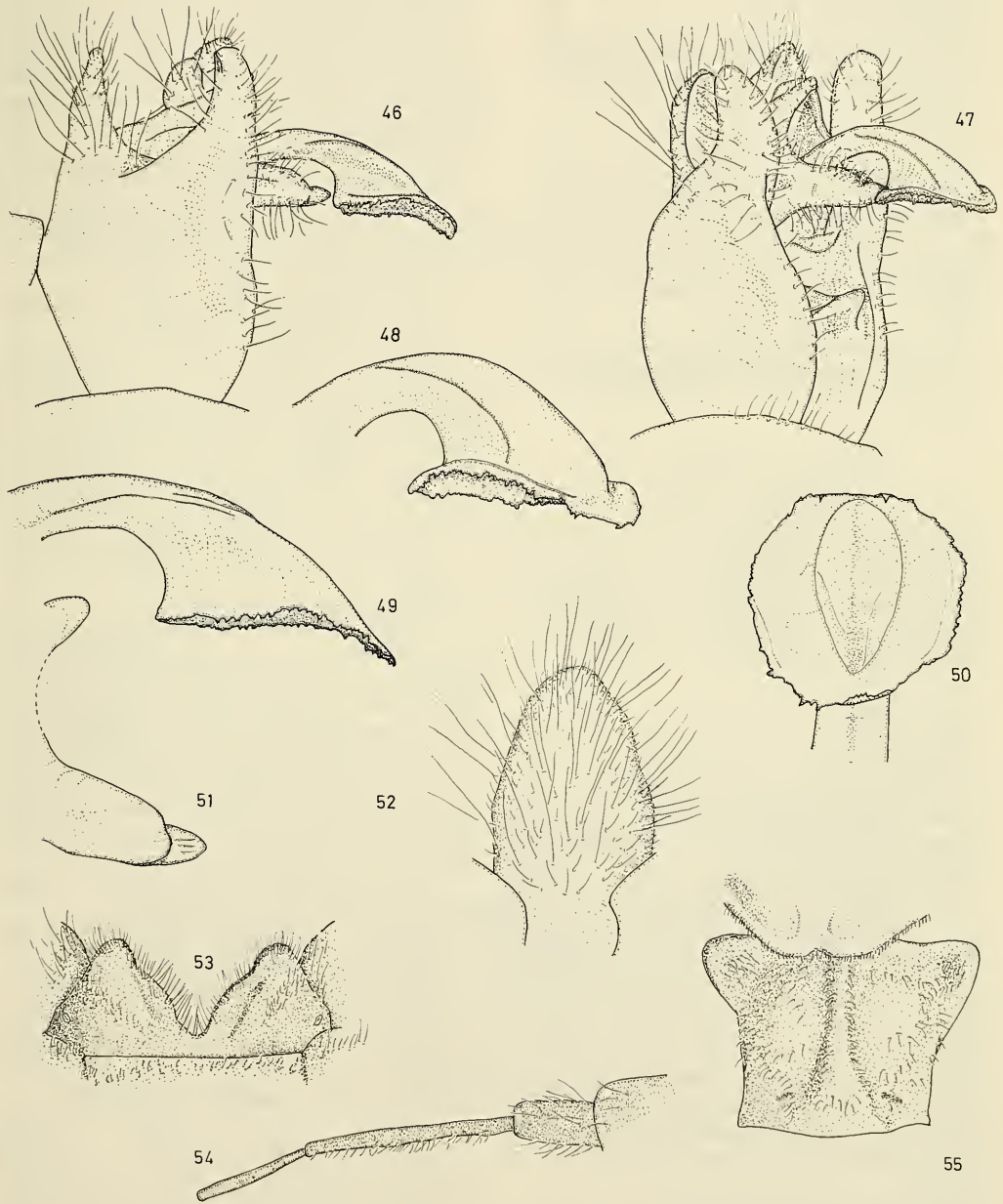

Figs. 46—55. *Lembeja pectinulata*; 46—52, 54, 55, ♂, holotype; 53, ♀, paratype Toli-Toli. 46, 47, pygofer, 46, lateral view, 47, ventrolateral view; 48—50, apex of aedeagus, 48, ventrolateral view, 49, lateral view, 50, ventral view; 51, clasper, lateral view; 52, sternite 8, ventral view; 53, sternite 7, ventral view; 54, left antenna segm. 1—4, lateral view; 55, tergite 1, dorsal view.



*ja maculosa* Distant 147.vii.13 ♀ (= Distant, 1892: p. 147, Pl. 7 fig. 13), 1 ♀ (MHNG). Specimens without precise locality: India Archipel, 1867, 1 ♂ (CNMW).

Etymology. — This is the first species in which the antennal comb on antennal segment 3 has been recognized. Pectinulata stands for "provided with a little comb".

#### Remarks.

*L. pectinulata* is the only species within the *L. foliata* group missing a dorsal aedeagal appendage. Whether this is caused by a fusion of the dorsal aedeagal appendage with the aedeagus itself or the loss of the appendage is still under study.

Furthermore, the tymbals of *L. pectinulata* have the highest number of ridges within the *foliata* group.

#### *Lembeja sangihensis* n.sp.

(figs. 55—56, map 2)

The species is described after two males and one female, which are not in a very good condition. As it is very peculiar in its aedeagal apex and as it is the only species from Sangihe known in the male sex, I believe its description as a separate species is justified.

#### Description.

Body ochraceous brown. Head and pronotum together 1.14—1.18 × as long as meso- and metanotum together. Thorax and head together in males 0.83, in the female 0.88 × as long as abdomen. Greatest width of body at the height of abdominal segment 3.

Head. — Antennae dark coloured from segment 2 to apex; combs present on segment 3 and 4. Eye small, 0.49—0.55 × as wide as vertex width between eyes. Ocelli slightly raised, distance between lateral ocelli in males 0.79—0.91, in the female 1.14 × distance between lateral ocellus and eye. Head 1.50—1.59 × as long as, 1.98—2.10 × as broad as width of vertex between eyes. Concolorous transverse ridges of postclypeus distinct in lateral view. Rostrum with its black apex reaching trochanter of middle leg.

Thorax. — Pronotum collar 1.61—1.67 × as wide as width of head including eyes, 2.12—2.24 × as wide as length of head. Four obconical areas indicated by patches.

Legs. — Concolorous with ventral part of thorax. Fore tibiae with two darker coloured

patches, one basally, one apically, as in *L. pectinulata*. Fore femora with three spines, basal longest one slightly pointed, middle- and small apical one pointed.

Tegmina and wings. — Tegmina subhyaline, yellow-brownish glossy. Venation light-ochraceous. Extreme base whitish. Spotted with red along the veins and inside the tegmen areas (alike *L. foliata*). Transverse vein of 2nd ulnar area slightly extending into the 3rd one, continued by a slight fold. Third ulnar area 0.97—1.02 × as long as 1st one; 4th ulnar area 0.98—1.1 × as long as radial area. Wings pale-hyaline, extreme base whitish. Fusion of the Cu<sub>2</sub> and A<sub>1</sub> at 74—84% from their origin.

Male: Operculum. — Small, meracanthus reaching over tymbal cavity.

Abdomen. — Pale-brownish. Distinctly carinated. Tergite 1 with its medial ridge ending in a triangular shaped bulb of moderate size, attached to tergite 2. Sclerotized flaps not extremely pointed. Proximal border of tergite 1 sturdy and whitish. Sternite 8 about triangular-shaped with a round apex.

Tymbals. — Provided with 21 long ridges alternating with an equal number of short, orange-brown coloured ridges.

Genitalia. — Caudal dorsal beak reaching just beyond anal valves, lateral lobes of pygofer slender. Edge running downwards from lateral lobe to base of pygofer nearly straight. In lateral view claspers fairly short and sturdy. Median uncus part fairly broad and apically pointed. Aedeagus stout, armoured laterally with a distinct ridge (fig. 57). Basally narrow aedeagal appendage unsclerotized, with an almost straight apex, not reaching apex of aedeagus.

Female: Operculum. — About sickle-shaped. Meracanthus just reaching sternite 3.

Abdomen. — Slender, carinate. Ovipositor sheath 0.36 × as long as abdomen.

Measurements of the types: Body length ♂: 15.9—16.5 mm, ♀: 22.6 mm; width of pronotum collar ♂: 5.1 mm, ♀: 6.5 mm; tegmen length ♂: 19.9 mm.

Distribution. — Sangihe island (map 2).

Types. — Indonesia, Sangihe: Holotype: "Sanghir/(Doherty)" (handwritten), "*Jacatra typica?*" (handwritten), "Distant Coll./1911-383" (print), "Brit. Mus." (print) 1 ♂ (BMNH). Paratypes: same data as holotype, 1 ♂ (BMNH); Faroena (= Tahuna?), J. H. Jurriaanse, 1 ♀ (RMNH).

Etymology. — The species derives its name from its distributional area, Sangihe island.

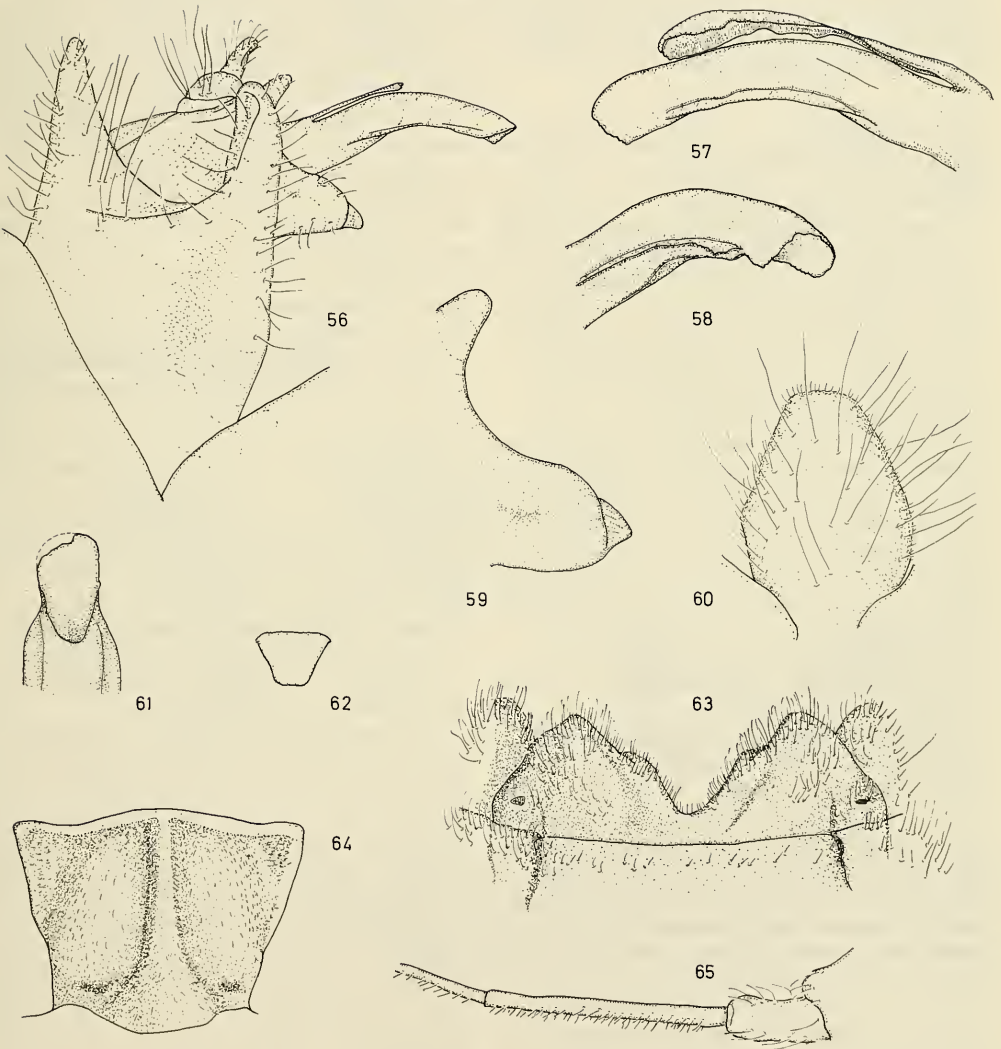

Figs. 56—65. *Lembeja sangihensis*; 56—62, 64, ♂; 63, 65, ♀, paratype. 56, pygofer, lateral view, paratype; 57, aedeagus with appendage, lateral view, paratype; 58, apex of aedeagus, ventrolateral view, paratype; 59, clasper, lateral view, paratype; 60, sternite 8, ventral view, holotype; 61, apex of aedeagus, ventral view, paratype; 62, apex of aedeagal appendage, ventral view, holotype; 63, sternite 7, ventral view; 64, tergite 1, dorsal view, holotype; 65, left antenna segm. 1—4, lateral view.

## Remarks.

*L. sangihensis* is very typical in its aedeagus and its unsclerotized, basally narrow aedeagal appendage.

**Lembeja hollowayi** n.sp.

(figs. 66—76, 141, 142, map 2)

This small species has been collected by Dr J. P. Duffels and Dr J. D. Holloway in the Dumoga-Bone N.P., and by Dr J. P. Duffels and Mrs M. J. Duffels in Central Sulawesi.

## Description.

Body yellowish green, sometimes with black spots. Thorax with black coloration dorsally. Red spots along the tegmen veins conspicuous. Body males more elongate in comparison to all other species of the *foliata* group, that have a more rounded or triangularly shaped body. Head and pronotum  $1.06\text{--}1.26 \times$  as long as meso- and metanotum together. Head and thorax in males  $0.67\text{--}0.88$ , in females  $0.79\text{--}1.0 \times$  as long as abdomen. Greatest width of body at the height of abdominal segment 3.

Head. — Antennae black coloured from 2nd segment to apex; combs present on segments 3 and 4. Females sometimes with black coloration on supra-antennal plates and area between ocelli. Eye rather large,  $0.53\text{--}0.60 \times$  as wide as vertex between eyes. Distance between lateral ocelli  $0.9\text{--}1.6 \times$  distance between lateral ocellus and eye. Head  $1.35\text{--}1.77 \times$  as long as,  $1.99\text{--}2.26 \times$  as wide as width of vertex between eyes. Rostrum with its black apex reaching trochanter of middle leg.

Thorax. — Pronotum collar usually with a black spot, which may continue as a black medial fascia on the pronotum. Pronotum collar  $1.51\text{--}1.74 \times$  as wide as width of head,  $1.98\text{--}2.47 \times$  as wide as length of head. Mesonotum with dark-brown mark on cruciform elevation. Some specimens with a large double-axe-shaped marking between small paramedian obconical areas and cruciform elevation; paramedian areas with a small brown-black spot.

Legs. — Concolorous. Fore tibiae with two conspicuous dark-coloured spots, placed as in *L. pectinulata* and *L. sangihensis*. Armature of fore femora as in *L. sangihensis*.

Tegmina and wings. — Tegmina hyaline. Veins of tegmina yellow to green coloured; costa and extreme base of tegmen whitish. Red spots along veins conspicuous; spots in cells of tegmen relatively faint. Tegmen-border with larger spots placed medially at apex of apical

areas. Large dark red spot at apex of  $Cu_{1b}$ . Third ulnar area  $0.87\text{--}1.13 \times$  as long as 1st one; 4th ulnar area  $0.86\text{--}1.04 \times$  as long as radial area. Wings with yellowish white veins; fusion of the  $Cu_2$  and  $A_1$  at  $78\text{--}90\%$  from their origin.

Male: Operculum. — Small, extending just over tymbal cavity; meracanthus long, may reach sternite 2.

Abdomen. — Green, sometimes slightly pale-green, coloured. Tergite 1 with its medial ridge ending distally in a triangular bulb of relatively moderate size. Sturdy proximal edge slightly concave near each of the hardly pointed, sclerotized flaps. Sternite 8 apically rounded.

Tymbal. — Provided with 18—19 long ridges, alternating with medially short orange-brown ridges.

Genitalia. — Caudal dorsal beak of moderate size, rounded apically. Lateral lobes of pygofer long and slender, in lateral view reaching just beyond caudal dorsal beak, strongly diverging in ventral view. Edge running downwards from lateral lobe to base of pygofer only slightly rounded. Claspers bulbous and sturdy, very conspicuous in ventral view; nail-shaped protrusion very small. Median uncus part smoothly narrowing into a pointed projection. Apex of aedeagus characteristic (fig. 70). Sclerotized dorsal aedeagal appendage with broad, incised apex, reaching apex of aedeagus.

Female: Operculum. — Small, rounded and sickle-shaped. Meracanthus reaching sternite 2.

Abdomen. — Carinate, ovipositor sheath  $0.35\text{--}0.48 \times$  as long as abdomen.

Measurements of the types: body length  $\delta$ :  $13.4\text{--}15.5$  mm,  $\bar{x} = 14.7 \pm 0.6$  mm,  $\text{♀}$ :  $14.6\text{--}16.8$  mm,  $\bar{x} = 15.8 \pm 0.7$  mm; width of pronotum collar  $\delta$ :  $4.2\text{--}4.9$  mm,  $\bar{x} = 4.5 \pm 0.2$  mm,  $\text{♀}$ :  $4.5\text{--}5.7$  mm,  $\bar{x} = 5.2 \pm 0.3$  mm; tegmen length  $\delta$ :  $16.3\text{--}17.9$  mm,  $\bar{x} = 17.2 \pm 0.7$  mm,  $\text{♀}$ :  $17.8\text{--}20.9$  mm,  $\bar{x} = 19.2 \pm 0.8$  mm.

Distribution. — North and Central Sulawesi (map 2).

Types. — Indonesia, Sulawesi: Holotype: "Stat. 15/Lowland rainforest/understorey/canopy/MV light-trap" (print), "Hog's Back Camp/600 m, S-side of/ridge, 12—13.ii.1985/J. P. Duffels & J. D. Holloway" (print), "Indonesia/Sulawesi Utara/Dumoga-Bone N.P./Project Wallace" (print), 1  $\delta$  (MZB). Paratypes: Sulawesi Utara, Dumoga Bone N.P.: Edwards Camp 664 m, st. 27, MV light-trap, understorey/canopy, 22.ii.1985, J. P. Duffels & J. D. Holloway, 1  $\text{♀}$  (ZMA); Hog's Back Camp 492



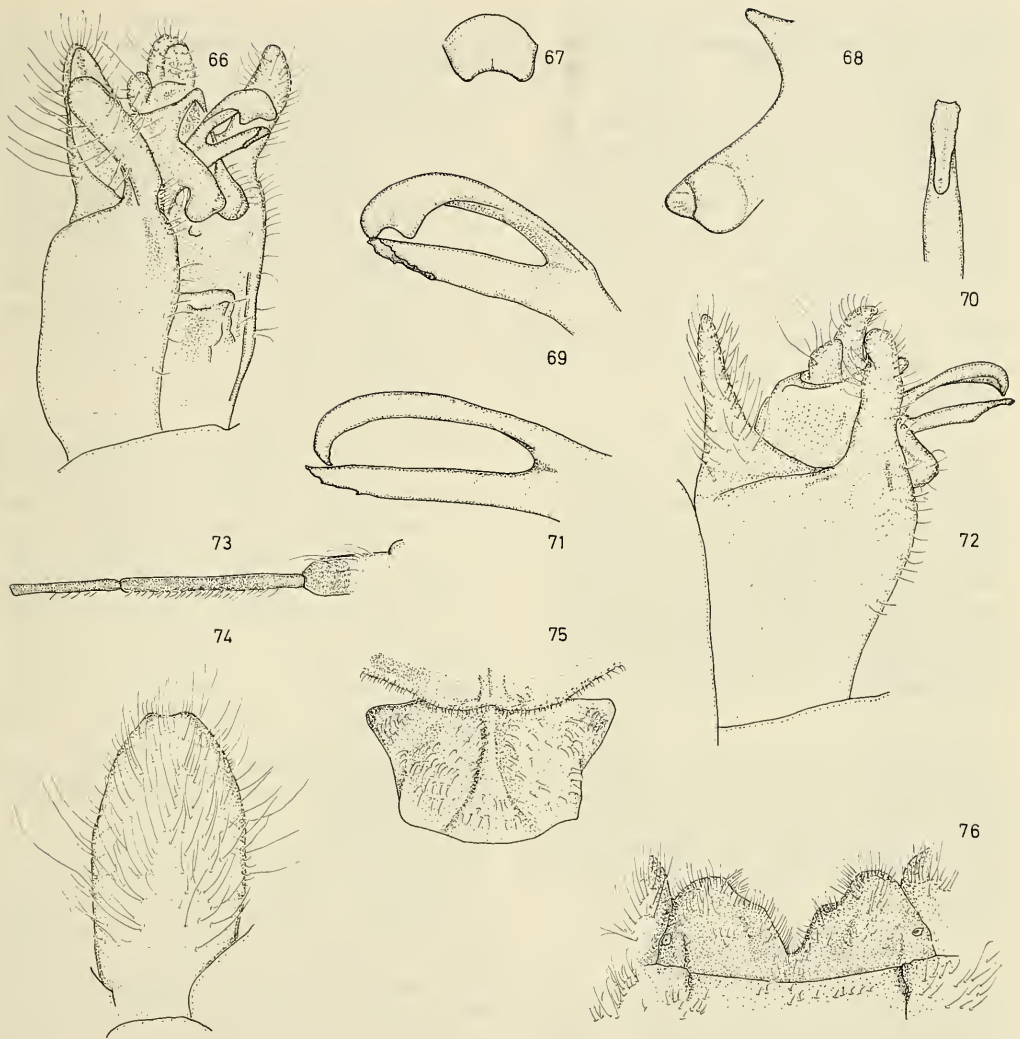

Figs. 66—76. *Lembeja hollowayi*; 66—75, ♂; 76, ♀, paratype Hog's Back Camp. 66, pygofer, ventrolateral view, paratype Toraut; 67, apex of aedeagal appendage, ventral view, paratype Toke Pangana; 68, clasper, lateral view, paratype Toke Pangana; 69, aedeagus with appendage, ventrolateral view, paratype Toke Pangana; 70, apex of aedeagus, ventral view, paratype Toke Pangana; 71, aedeagus with appendage, lateral view, paratype Toke Pangana; 72, pygofer lateral view, paratype Toraut; 73, left antenna segm. 2—4, lateral view, paratype, Toke Pangana; 74, sternite 8, ventral view, holotype; 75, tergite 1, dorsal view, holotype; 76, sternite 7, ventral view.

m, st. 13, lowl. rainf., MV light-trap, canopy, N-side of ridge, 10—11.ii.1985, J. P. Duffels & J. D. Holloway, 1 ♀ (MZB), 2 ♀ (ZMA), same data but: st. 15, understorey/canopy, MV light-trap, S-side of ridge, 12—13.ii.1985, 1 ♀ (MZB), 1 ♂ (ZMA), same data but: st. 30A, MV light-trap, canopy, 14.ii.1985, J. D. Holloway, 1

♀ (MZB), 1 ♂ 2 ♀ (ZMA); Page (= Barney's) Camp 302 m, st. 9, lowl. rainf., MV light-trap, 4—8.ii.1985, J. P. Duffels & J. D. Holloway, 1 ♂ (MZB); Toraut, st. 7, lowl. rainf., MV light-trap, 1—2.ii.1985, J. P. Duffels & J. D. Holloway, 1 ♀ (MZB), 2 ♀ (ZMA), same data but: st. 16, light-trap site 1+2, understorey/canopy,

7—13.ii.1985, H. S. Barlow, 1 ♀ (MZB), 1 ♀ (ZMA), same data but: st. 23, light-trap site 2, 26.ii.1985, 1 ♂ 1 ♀ (MZB), 1 ♂ 2 ♀ (ZMA), same data but: st. 24, light-trap site 1, 15—26.ii.1985, 1 ♀ (MZB), 1 ♂ 2 ♀ (ZMA); Tumpah River; st. 34, secondary forest, 26—29.ii.1985, J. P. Duffels, 1 ♀ (ZMA). Sulawesi Tengah, Lore Lindu N.P.: Marena, Hihia 360 m, 10 km NE Gimpu, st. 48, lowl. rainf. riverbank, ML-light, 19.iii.1985, J. P. & M. J. Duffels, 1 ♂ 1 ♀ (ZMA), same data but: st. 49, 400 m, along narrow stream, 20.iii.1985, 2 ♂ (ZMA); Toke Pangana 700 m, st. 44, 4 km NE Gimpu, 16.iii.1985, J. P. & M. J. Duffels, 1 ♂ 4 ♀ (ZMA).

**Etymology.** — The species is named after the distinguished British lepidopterist Dr J. D. Holloway (Commonwealth Institute of Entomology), the Director of the Diversity and Conservation Programme of the "Project Wallace" Expedition. Dr Holloway has made important contributions to the knowledge and understanding of distribution patterns in the Indo-Pacific. He stimulated the study of the biogeography of cicadas in this region, e.g. by his extensive collecting.

#### Remarks.

*L. hollowayi* and *L. oligorhanta* n.sp., characterized by their bulbous claspers and diverging lateral lobes, are closely related. Differences are found in the shape of the aedeagal appendage, the density of red spots on the tegmina and the body size.

#### *Lembeja oligorhanta* n.sp.

(figs. 77—86, map 2)

The species is described in comparison with *L. hollowayi*, after two males and five females, all from the Lore-Lindu N.P. in Central Sulawesi.

#### Description.

Larger than *L. hollowayi*. Body green, thorax sometimes with black coloration dorsally. Red spots along veins in tegmina usually only present in basal half. Head and pronotum 1.03—1.16 × as long as meso- and metanotum together. Head and thorax in males 0.8—0.9, in females 0.77—1.01 × as long as abdomen. Greatest width of body at the height of pronotum collar.

**Head.** — Antennae black coloured from 2nd segment to apex; combs present on segments 3 and 4. Females sometimes with black coloration

between eyes, on supra-antennal plates and postclypeus. Eyes rather large, 0.53—0.67 × as wide as vertex between eyes. Distance between lateral ocelli 0.90—1.37 × distance between lateral ocellus and eye. Head 1.39—1.77 × as long as, 2.14—2.32 × as wide as width of vertex between eyes. Rostrum as in *L. hollowayi*.

**Thorax.** — Pronotum collar usually with a black spot, which may continue in a broad, black, medial fascia on pronotum. Pronotum collar 1.54—1.78 × as wide as width of head, 2.0—2.63 × as wide as length of head. Mesonotum, and its eventual black markings, as in *L. hollowayi*.

**Legs.** — As in *L. hollowayi*.

**Tegmina and wings.** — Tegmina hyaline. Coloration of venation as in *L. hollowayi*. Red spots along veins usually only conspicuous in basal part of tegmen, spots within cells of tegmen usually not present, except at tegmen-border at the height of apical area 8. Third ulnar area 0.93—1.09 × as long as 1st one; 4th ulnar area 0.88—0.95 × as long as radial are. Wings as in *L. hollowayi*, fusion of  $Cu_2$  and  $A_1$  at 82—91%.

**Male: Operculum.** — Relatively larger than in *L. hollowayi*, meracanthus just not reaching sternite 2.

**Abdomen.** — Green. Tergite 1 with a very small triangular-shaped bulb. Other features as in *L. hollowayi*.

**Tymbal.** — Provided with 21 long ridges alternating with medial short brown ridges.

**Genitalia.** — Caudal dorsal beak of moderate size, rounded apically. Lateral lobes less slender than in *L. hollowayi*, diverging in ventral view. Edge running downwards from lateral lobe to base of pygofer only slightly rounded. Claspers less bulbous than in *L. hollowayi*, nail-shaped protrusion larger than in *L. hollowayi*. Median uncus part less pointed than in *L. hollowayi*. Apex of aedeagus as in fig. 79. Small, tapering apex of sclerotized dorsal aedeagal appendage slightly incised, reaching apex of aedeagus.

**Female: Operculum.** — As in *L. hollowayi*. Meracanthus usually reaching over sternite 3.

**Abdomen.** — As in *L. hollowayi*. Ovipositor sheath 0.38—0.47 × as long as abdomen.

Measurements of the types: body length ♂: 18.4 mm, ♀: 18.4—19.1 mm,  $\bar{x}$  = 18.8 ± 0.3 mm; width of pronotum collar ♂: 4.7—5.5 mm, ♀: 6.1—6.5 mm,  $\bar{x}$  = 6.21 ± 0.2 mm; tegmen length ♂: 20.5—21.3 mm, ♀: 21.7—24.1 mm,  $\bar{x}$  = 22.6 ± 0.8 mm.

**Distribution.** — Central Sulawesi (map 2).

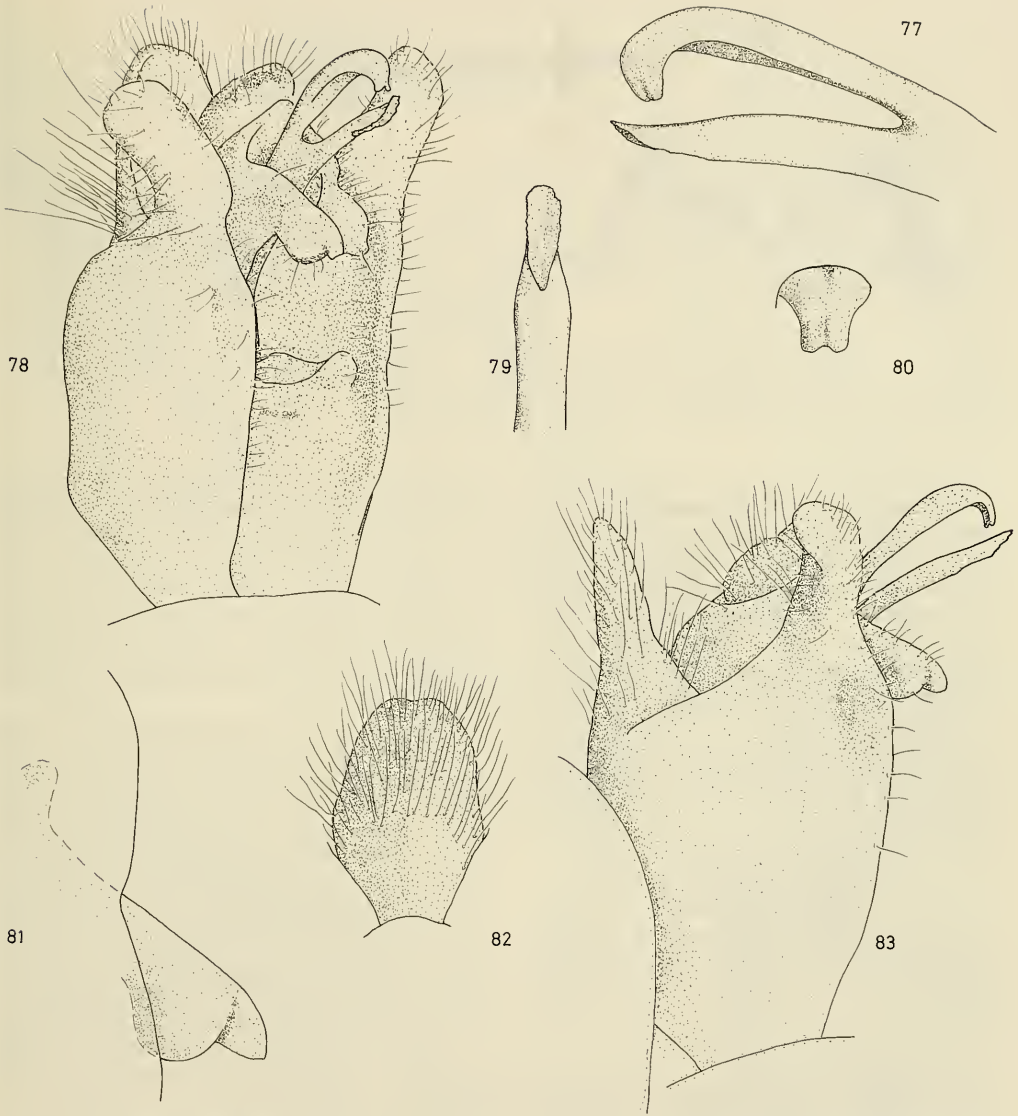

Figs. 77—83. *Lembeja oligorbanta*; 77—81, 83, holotype, 82, ♂, paratype. 77, aedeagus with appendage, ventrolateral view; 78, pygofer, ventrolateral view; 79, apex of aedeagus, ventral view; 80, apex of aedeagal appendage, ventral view; 81, clasper, lateral view; 82, sternite 8, ventral view; 83, pygofer, lateral view.

Types. — Indonesia, Sulawesi: Holotype: "Museum Leiden Sulawesi/Palu, 50 km SE of: Lore/Lindu NP, Dongi Dongi sh./UTM SJ 86; 950 m; 3 Dec. 1985 B/ Van Tol & Krikken" (partly print, partly handwritten), 1 ♂ (RMNH). Paratypes: Sulawesi Tengah, Lore-Lindu N.P.: same data as holotype but: 4.xii.1985, 1 ♂ 1 ♀ (RMNH), same data but:

4—9.xii.1985, 2 ♀ (RMNH), same data but: 7.xii.1985, 1 ♀ (ZMA), same locality but: st. 52, ML-light, 90 km SE of Palu, 23.iii.1985, J. P. & M. J. Duffels, 1 ♀ (ZMA).

Etymology. — The name of the species refers to its sparsely spotted tegmina. "Oligo" (Greek) stands for little, and "rhanta" (Greek) for sprinkled.



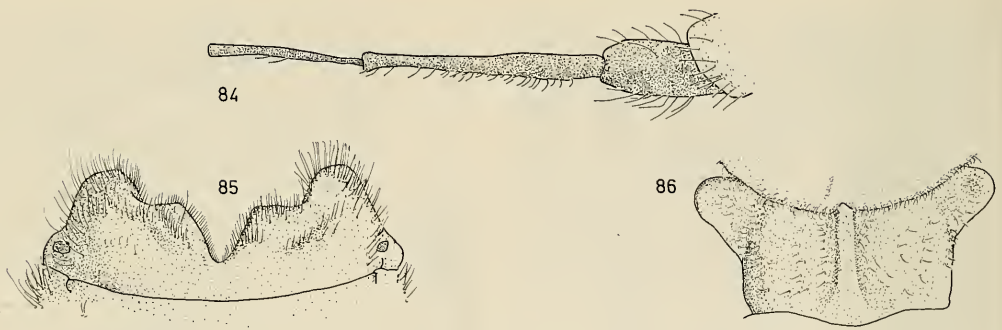

Figs. 84—86. *Lembeja oligorbanta*, 84, 86, holotype, 85, ♀, paratype. 84, left antenna segm. 2—4, lateral view; 85, sternite 7, ventral view; 86, tergite 1, dorsal view.

#### Remarks.

*L. oligorbanta* is easily distinguished from the other species of the *foliata* group, because of its hardly spotted tegmina. It appears to be most closely related to *L. hollowayi*, which is strongly suggested by the shape of the lateral lobes and the claspers. Though both present in Central Sulawesi, they are probably confined to a different altitude, as can be read from the data (*L. hollowayi*: 200—700 m; *L. oligorbanta*: 950 m). A difference in size between the two species is also apparent. A discussion on a possible relation between size and altitude is given in the remarks on *L. incisa* n.sp.

#### *Lembeja mirandae* n.sp. (figs. 87—96, map 2)

This species, one of the largest of the *foliata* group, is described after one male and one female from the Lore-Lindu N.P. in Sulawesi Tengah.

#### Description.

Fairly large and robust species coloured with brown, yellow to pale-ochraceous and black. Ventrally pale-ochraceous. Pigmentation of apical cells of the tegmen with relatively large, dark-red spots. Head and pronotum together 1.15—1.18 × as long as meso- and metanotum together. Head and thorax in the males 0.76 ×, in the females 0.87 × as long as abdomen. Greatest width of body at the height of abdominal segment 3.

Head. — Antennae dark coloured, especially from segment 2 to apex. Combs weakly developed on segment 3, hardly present on segment 4. Eye 0.59 × as wide as width of vertex between eyes. Area between raised ocelli and on

supra-antennal plates slightly darker coloured than rest of head; distance between lateral ocelli 0.93—1.14 × distance between lateral ocellus and eye. Head 1.52—1.68 × as long as, 2.18 × as wide as width of vertex between eyes. Postclypeus very narrow in lateral view, its upper portion slightly darker coloured in lateral view. Rostrum with dark apex reaching coxae of middle legs.

Thorax. — Pronotum collar greenish tinged with a medially placed pale-brown spot, widely amplified at lateral corners; 1.69—1.81 × as wide as width of head including eyes, 2.34—2.41 × as wide as length of head. Ochraceous-brown pronotum slightly domed. Mesonotum of the male with a light ochraceous-brown area in front of cruciform elevation, two small dark-brown paramedian, obconical areas and dark-brown lateral sides. Mesonotum of female on the whole fairly dark. Cruciform elevation and metanotum medially brown.

Legs. — Concolorous with underside of body except for fore tibiae and intermediate coxae. Darkening towards claws. Fore tibiae with a large apical spot and a slightly smaller one at 1/3 from their bases. Armature of fore femora consisting of a basal, slightly pointed, relatively thick and round thorn, and two more apically situated pointed spines; most apical one the smallest. All thorns dark-coloured.

Tegmina and wings. — Hyaline tegmina with yellowish-greenish veins; costa with its basal half brownish coloured, slightly depressed beyond base. Extreme base whitish-pink, basal area infuscated. Transverse vein of 2nd ulnar area extending well into 3rd ulnar area; continued by a distinct corial fold. Dark-red to brown spots in cells of tegmen. Heavily pigmented

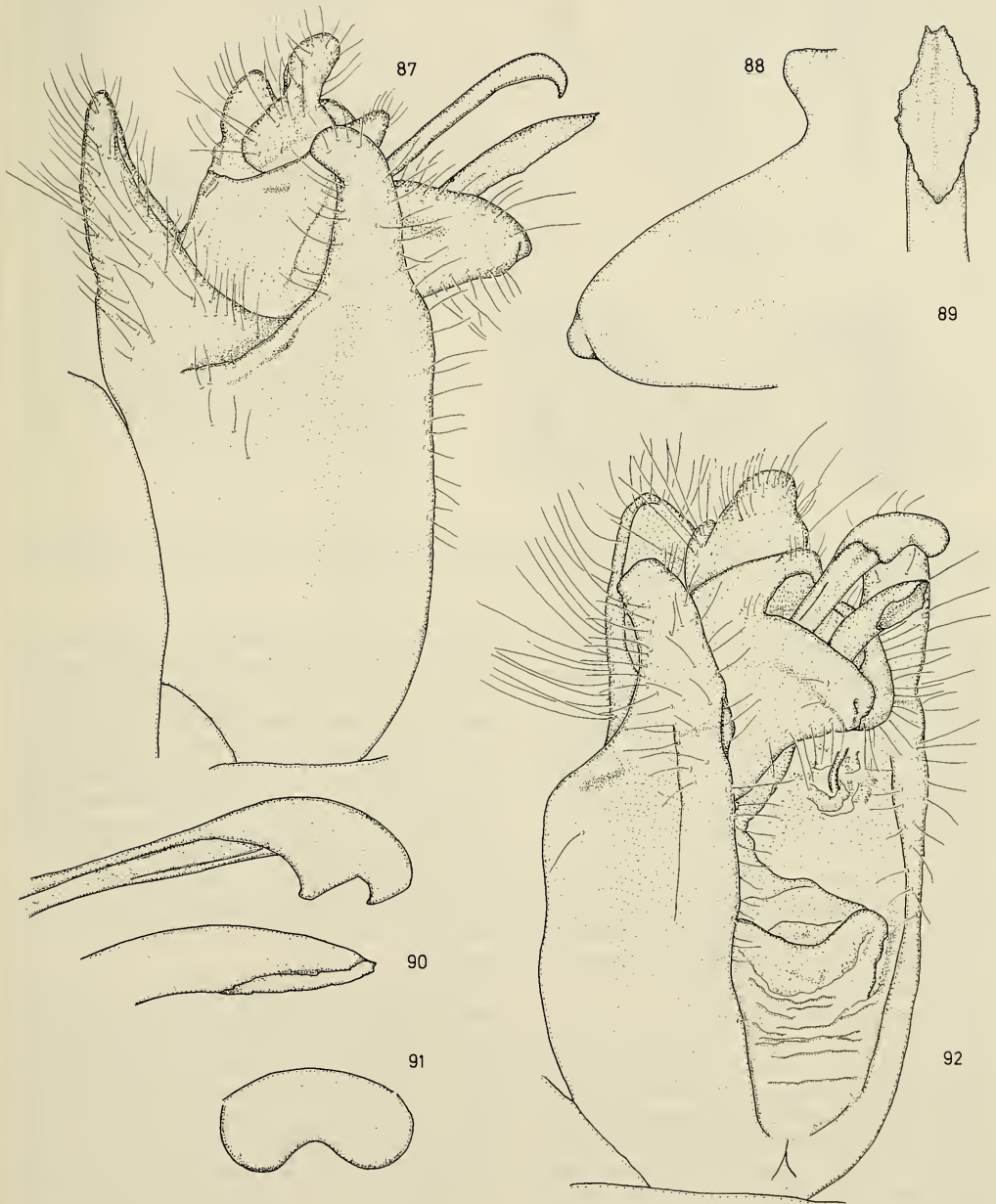

Figs. 87—92. *Lembeja mirandae*, holotype. 87, pygofer, lateral view; 88, clasper, lateral view; 89, apex of aedeagus, ventral view; 90, aedeagus with appendage, ventrolateral view; 91, apex of aedeagal appendage, ventral view; 92, pygofer, ventrolateral view.

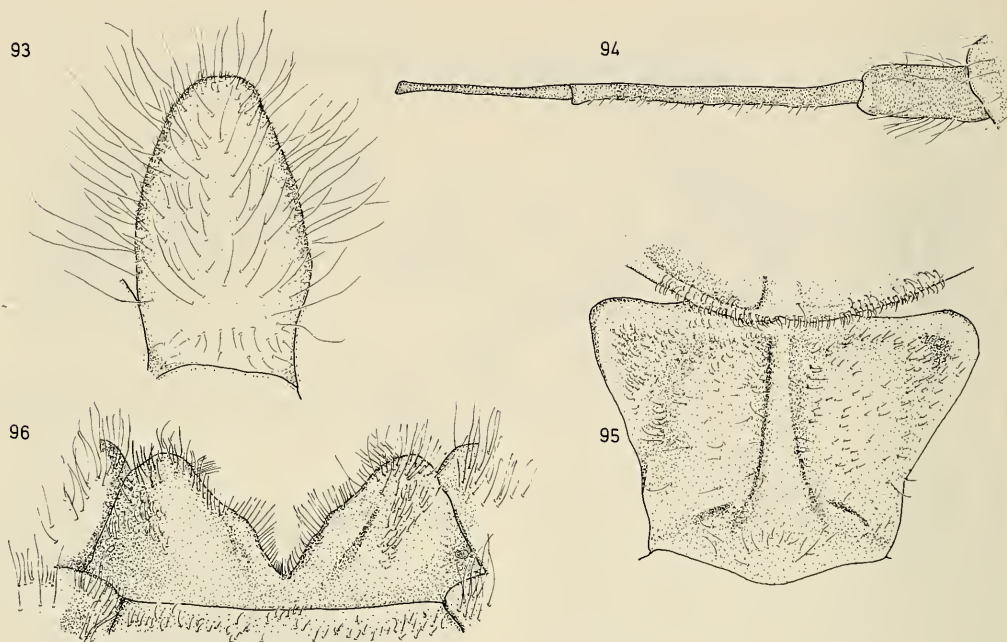

Figs. 93—96. *Lembeja mirandae*; 93—95, holotype; 96, paratype. 93, sternite 8, ventral view; 94, left antenna segm. 1—4, lateral view; 95, tergite 1, dorsal view; 96, sternite 7, ventral view.

with brown in apical half of 4th ulnar area along corial fold. Large brownish red spots at tegmen border medially placed at apices of apical areas. Node halfway  $M_{3+4}$  distinct. Third ulnar area  $0.93 \times$  as long as 1st one; 4th ulnar area  $0.94—0.98 \times$  as long as radial area. Wings hyaline with red veins, extreme base whitish-pink. Fusion of  $Cu_2$  and  $A_1$  at 91% of their length.

Male: Operculum. — Dark coloured, large (compared to opercula of other members of the same subgroup), just reaching over tymbal cavity. Pale-ochraceous meracanthus reaching well over tymbal cavity.

Abdomen. — Greenish brown, ventrally as well as laterally paler coloured. Tergite 1 darker than other tergites, its proximal edge thickened, somewhat lighter coloured, rounded at the sclerotized flaps. Triangular bulb depressed, leveling it distally with the slightly depressed lateral parts of the tergite. Sternites with small, medial light-brown spots. Sternite 8 large, apically straight to rounded.

Tymbals. — Nineteen long and an equal number of short orange-brown ridges.

Genitalia. — Caudal dorsal beak not extending beyond anal valves, apically rounded.

Lateral pygofer lobes fairly short. Edge running downwards from each lateral lobe to base of pygofer apically slightly produced. Claspers in lateral view broad. Nail-shaped protrusion only small. Median uncus part with a broad protrusion. Aedeagus with broad apex, dorsally only very slightly produced. Sclerotized aedeagal appendage stout, apically rounded, reasonably incised; reaching apex of aedeagus. Adjustment of aedeagus relatively high in ventral view.

Female: Operculum. — Small, dark coloured. Meracanthus apically dark and reaching over sternite 3.

Abdomen. — Light-ochraceous with two lateral, broad dark-coloured fasciae, running from segment 3 to segment 8, and a more narrow, medial dorsal light-coloured fascia running up to pale-ochraceous caudal dorsal beak. Distal edges of tergites light coloured. Sternites 3—6 with median, slightly darker triangular spots. Ovipositor sheath somewhat darker coloured than pale-ochraceous segment 9; its apex, being  $0.39 \times$  as long as abdomen, even darker.

Measurements of the types: body length  $\delta$ : 22.8 mm,  $\text{♀}$ : 20.4 mm; width of pronotum collar  $\delta$ : 7.6 mm,  $\text{♀}$ : 7.2 mm; tegmen length  $\delta$ : 25 mm,  $\text{♀}$ : 24.6 mm.





Figs. 97—103. *Lembeja majuscula*, holotype. 97, pygofer, lateral view; 98, apex of aedeagal appendage, ventral view; 99, clasper, lateral view; 100, apex of aedeagus, ventral view; 101, 102, aedeagus with appendage, 101, lateral view, 102, ventrolateral view; 103, pygofer, ventrolateral view.

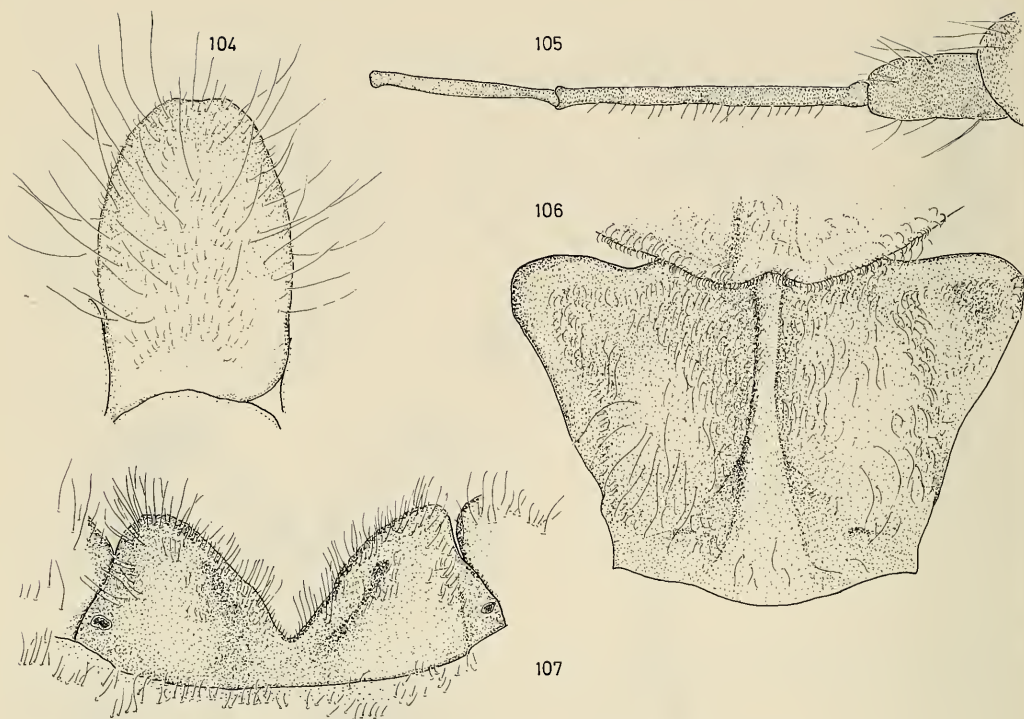

Figs. 104—107. *Lembeja majuscula*; 104—106, holotype; 107, ♀, paratype. 104, sternite 8, ventral view; 105, left antenna segm. 1—4, lateral view; 106, tergite 1, dorsal view; 107, sternite 7, ventral view.

Distribution. — Central Sulawesi (map 2).

Types. — Indonesia, Sulawesi: Holotype: "Stat. 41/Lower montane/forest/MV light" (print), "Rano Rano, 1600 m/10 km NE Gimpu/14.iii.1985/J. P. & M. J. Duffels" (print), "Indonesia/Sulawesi Tengah/Lore Lindu N.P." (print), 1 ♂ (ZMA). Paratype: same data as holotype but: st. 43, 15.iii.1985, 1 ♀ (ZMA).

Etymology. — This beautifully pigmented species is dedicated to a very special friend with the most appropriate name Miranda, which, in Latin, stands for "to be admired".

#### Remarks.

*L. mirandae*, *L. majuscula* n.sp. and *L. incisa* n.sp. are the only three species described within the *foliata* subgroup that are more or less heavily pigmented, as well considering their body as their tegmina. To a certain extent these three species remind of the *L. distanti* subgroup in some features, viz. tergite 1 depressed distally on both sides of the medial ridge, and as for *L. mirandae* and *L. majuscula* n.sp., the weakly developed antennal combs and the heavily pigmented tegmina.

#### *Lembeja majuscula* n.sp. (figs. 97—107, 143, 144, map 2)

This largest and most heavily pigmented species of the *foliata* group is described in comparison with *L. mirandae* after two males and one female from the Lore-Lindu N.P. in Central Sulawesi.

#### Description.

A large hairy species with brown to ochraceous ground-colour, which is tinged with green, and some dark patches on the thorax. Ventrally slightly paler than dorsally. Pigmentation of cells of tegmina very conspicuous. Head and pronotum together 1.02—1.09 × as long as meso- and metanotum together. Head and thorax together in males 0.70—0.71 ×, in the female 0.86 × as long as abdomen. Greatest width of body at the height of abdominal segment 3.

Head. — Dark or light-ochraceous to brownish green. Eye 0.53—0.54 × as wide as width of vertex between eyes. More or less darker coloured between raised ocelli and on edge of supra-antennal plate; distance between lateral ocelli 0.84—1.15 × distance between lateral

ocellus and eye. Antennae dark coloured, especially from segment 2 to apex. Combs only very slightly developed on segment 3. Head 1.52—1.61 × as long as, 2.06—2.07 × as wide as width of vertex between eyes. Upper portion of postclypeus in lateral view somewhat darker coloured, female with ventrally a median dark stripe.

Thorax. — Pronotum irregularly patched with darker spots. Pronotum collar tinged with green, 1.78—1.91 × as wide as width of head, 2.37—2.60 × as wide as length of head. Obconical areas on mesonotum hardly discernable, paramedian ones indicated by a narrow light-coloured margin. Greatest part of cruciform elevation light-coloured, with a median dark-brown line, continued on the metanotum.

Legs. — As in *L. mirandae*, but slightly darker.

Tegmina and wings. — General shape and coloration as in *L. mirandae*, but tegmina, especially in the female, with distinctly heavier pigmentation in cells of the tegmina and along veins than in *L. mirandae*. Heavily pigmented in apical half of 4th ulnar area near corial fold, and in 8th apical area. Extreme base whitish-pink. Third ulnar area 0.91—1.01 × as long as 1st one; 4th ulnar area 1.01—1.11 × as long as radial one. Wings as in *L. mirandae*, extreme base more whitish coloured. Fusion of  $Cu_2$  and  $A_1$  at 73—85% from their origin.

Male: Operculum. — Dark coloured, relatively large. Meracanthus reaching well over tymbal cavity.

Abdomen. — Broadly shaped, greenish coloured; sternites with medial light-brown spots, less conspicuous than in *L. mirandae*. Tergite 1 as in *L. mirandae*. Mediodorsally dark-coloured along the carination of segment 3—8. Tergite 1 as in *L. mirandae*. Sternite 8 relatively broad; apex rounded and dark.

Tymbals. — Provided with 20 long, medially dark-coloured ridges alternating with 19 short, orange-brown coloured ones.

Genitalia. — Caudal dorsal beak dark-coloured and apically pointed. Lateral lobes broad, slightly darkening to their apices. Edge running downwards from lateral lobe to base of pygofer slightly produced just under lateral lobe. Claspers narrow, long and dark in lateral view. Nail-shaped protrusion of clasper small. Median unicus part slightly produced. Sclerotized aedeagal appendage stout, apically fairly deeply incised, creating two very short pointed processes, reaching apex of aedeagus. Aedeagus relatively

less broad than in *L. mirandae*.

Female: Operculum. — Small, dark coloured. Meracanthus reaching over sternite 3.

Abdomen. — Ochraceous with three broad, dark-coloured fasciae, the upper edges of the lateral ones almost touching the edges of the dorsal one; dorsal one very dark on segment 9, including caudal dorsal beak, lateral ones not reaching hind margin of segment 8. Hind margins of tergites lighter coloured. Ovipositor sheath dark, especially at apex; 0.36 × as long as abdomen.

Measurements of the types: body length ♂: 24.3—25.5 mm, ♀: 2.16; width of pronotum collar ♂: 8.3—8.4 mm, ♀: 7.9 mm; tegmen length ♂: 27—27.7 mm, ♀: 26.1 mm.

Distribution. — Central Sulawesi (map 2).

Types. — Indonesia, Sulawesi: Holotype: "Stat. 55/Disturbed lower/montane forest/ML-light, canopy" (print), "10 km SE Poloka/1900m, 25.iii.1985/J. P. & M. J. Duffels" (print), "Indonesia/Sulawesi Tengah/Lore Lindu N.P." (print), 1 ♂ (ZMA). Paratypes: same data as holotype, 1 ♂ (MZB) 1 ♀ (ZMA).

Etymology. — The name of this heavily pigmented species, "*majuscula*", refers to its larger size compared to the other, slightly less heavy pigmented species within the *foliata* subgroup, *L. mirandae*.

Remarks.

*L. majuscula*, *L. mirandae* and *L. incisa* n.sp. seem to form a separate taxonomic unit within the *foliata* subgroup, because of the pigmentation, the size of the male opercula, the shape of the male tergite 1 and some features in the male genitalia. *L. majuscula* differs, apart from its size, from *L. mirandae* in the darker coloured body and the more conspicuous pigmentation of the cells of the tegmina.

***Lembeja incisa* n.sp.**  
(fig. 108—117, map 2)

This small, pigmented species is described in comparison with *L. mirandae* after two males and five females from the Lore-Lindu N.P. in Central Sulawesi.

Description.

Small, pigmented species, coloured with olivaceous-green, brown to dark-brown. Ventrally pale-ochraceous. Apical cells of tegmina shaded, hardly consisting of dark-brown spots. Head and pronotum together 1.09—1.31 × as long as meso- and metanotum together. Head and tho-



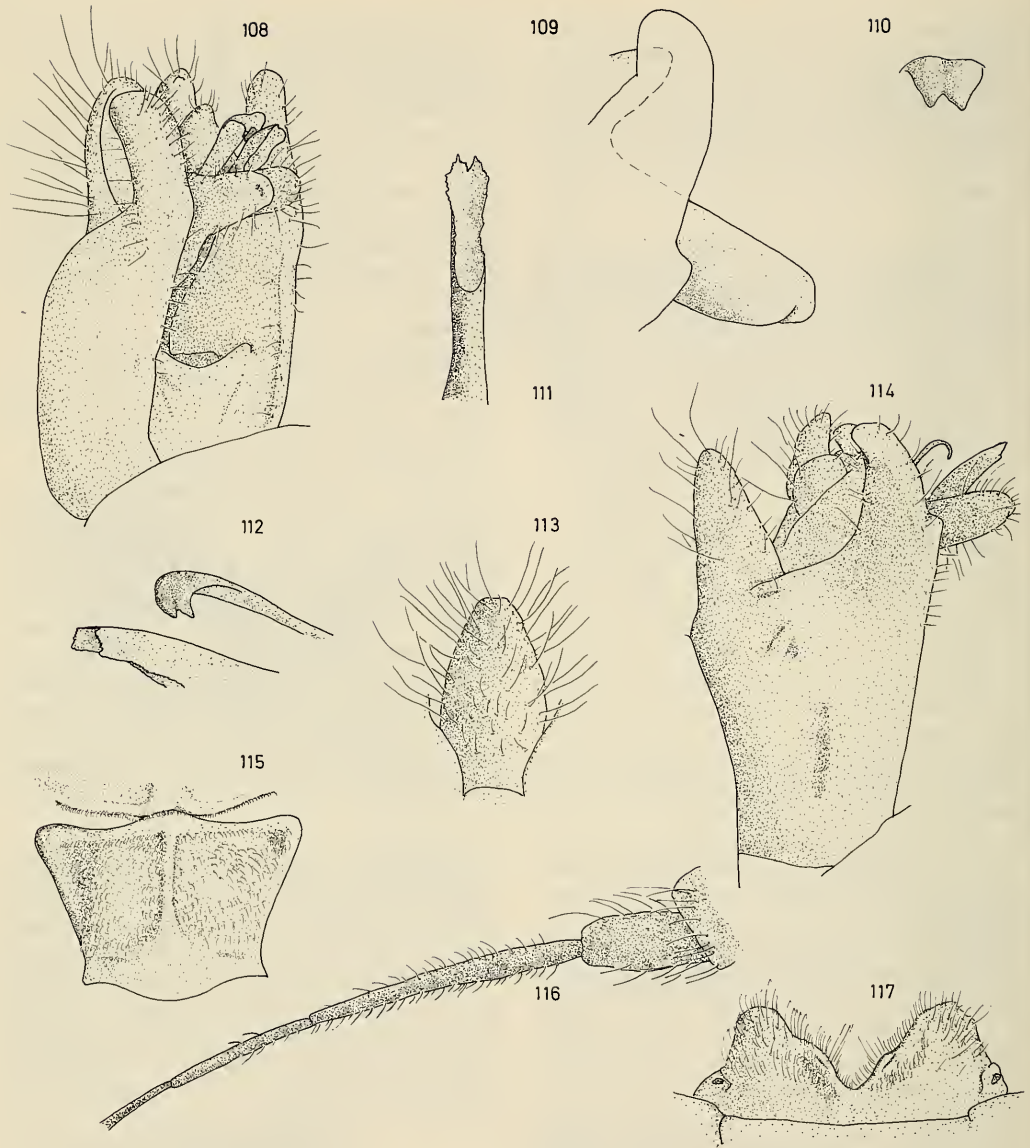

Figs. 108—117. *Lembeja incisa*; 108—110, 112, 114, 115, holotype, 111, 113, ♂, paratype; 116, 117, ♀, paratype. 108, pygofer, ventrolateral view; 109, clasper, lateral view; 110, apex of aedeagal appendage, ventral view; 111, apex of aedeagus, ventral view; 112, aedeagus with appendage, ventrolateral view; 113, sternite 8, ventral view; 114, pygofer, lateral view; 115, tergite 1, dorsal view; 116, left antenna segm. 2—4, lateral view; 117, sternite 7, ventral view.

rax in males  $0.77\text{--}0.85\times$ , in females  $0.89\text{--}1.12\times$  as long as abdomen. Greatest width of body at the height of abdominal segment 3.

Head. — Antennae dark coloured. Combs less weakly developed than in *L. mirandae*, present on both antennal segment 3 and 4. Eyes  $0.52\text{--}0.58\times$  as wide as width of vertex in be-

tween eyes. Ground colour of head olivaceous; dark-brown between lateral ocelli, paler brown on supra-antennal plates and sometimes on postclypeus. Distance between lateral ocelli  $1.0\text{--}1.15\times$  distance between lateral ocellus and eye. Head  $1.41\text{--}1.68\times$  as long,  $2.03\text{--}2.16\times$  as wide as width of vertex in between eyes. In

lateral view upper portion of postclypeus darker coloured than basal portion. Rostrum as in *L. mirandae*.

Thorax. — Pronotum on the whole fairly olivaceous-greenish tinged, with irregularly brown pronotum collar, fissures and central fascia. Pronotum collar  $1.54\text{--}1.69 \times$  as wide as width of head,  $2.09\text{--}2.45 \times$  as wide as length of head. Olivaceous-green mesonotum usually covered with brown patches, as in *L. mirandae* and *L. majuscula*. Cruciform elevation and metanotum medially brown, its distal edge more covered with brown than in *L. mirandae* and *L. majuscula*. Ventrally paler, though dark patches sometimes present.

Legs. — As in *L. mirandae*, but dark coloured patches more conspicuous.

Tegmina and wings. — Tegmina generally as in *L. mirandae*, but less spotted within the tegmen cells, especially apical areas 1—7. Third ulnar area  $0.76\text{--}0.98 \times$  as long as 1st one; 4th ulnar area  $0.89\text{--}1.02 \times$  as long as radial vein. Wings as in *L. mirandae*, fusion of  $Cu_2$  and  $A_1$  at 80—89% of their length.

Male: Operculum. — Slightly darker than body ventrally. Small, hardly reaching over tymbal cavity. Meracanthus pale-ochraceous, reaching just over tymbal cavity.

Abdomen. — Olivaceous-green. Tergite 1 almost completely dark coloured, shape as in *L. mirandae*. Medio-dorsally dark coloured along tergites 2—8. Two lateral broad, dark coloured fasciae, running from segment 3—7. Sternites pale olivaceous-green. Sternite 8 small, apically more pointed than in *L. mirandae*.

Tymbals. — Eighteen long and an equal number of short orange-brown ridges.

Genitalia. — Caudal dorsal beak just not extending beyond anal valves, apically rounded. Lateral pygofer lobes fairly long, slightly diverging in ventral view. Edge running downwards from each lateral lobe to base of pygofer apically produced. The flat enlargement very narrow. Claspers in lateral view narrow, as in *L. pectinulata*. Nail-shaped protrusion small. Median uncus part reasonably pointed. Broad apex of aedeagus with a slight dorsal incision. Weakly sclerotized aedeagal appendage not reaching apex of aedeagus; shape as in *L. majuscula*. Adjustment of aedeagus as in *L. mirandae*.

♀: Operculum. — Small, slightly dark coloured. Pale ochraceous meracanthus reaching just over sternite 3.

Abdomen. — Ochraceous. The two lateral fasciae running from segment 3—7 and the dor-

sal fascia running from segment 1 up to the caudal dorsal beak as in *L. mirandae*, though more prominent. Distal edges of tergites 1—7 concolorous with the dorsal fascia. Sternites pale ochraceous. Ovipositor sheath  $0.33\text{--}0.36 \times$  as long as abdomen, somewhat darker coloured than pale ochraceous segment 9.

Measurements of the types: body length ♂:  $14.2\text{--}15$  mm, ♀:  $15.1\text{--}16.7$  mm,  $\bar{x} = 16.0 \pm 0.7$  mm; width of pronotum collar ♂:  $4.7$  mm, ♀:  $5.5\text{--}5.8$  mm,  $\bar{x} = 5.7 \pm 0.1$  mm; tegmen length ♂:  $17.2\text{--}17.8$  mm, ♀:  $18.7\text{--}20.9$  mm,  $\bar{x} = 19.8 \pm 0.8$  mm.

Distribution. — Central Sulawesi (map 2).

Types. — Indonesia, Sulawesi: Holotype: "Museum Leiden Sulawesi/Palu, 65 km SSE of Lore/Lindu NP, Marena shelter./UTM SJ62; 13 Dec. 1985 A/Van Tol & Kriksen" (partly print, partly handwritten), 1 ♂ (RMNH). Paratypes: Sulawesi Tengah, Lore Lindu N.P.: same data as holotype but: 13.xii.1985, 1 ♀ (RMNH), 14.xii.1985, 1 ♂ (RMNH), same data but: 16.xii.1985, 1 ♀ (ZMA), same data but: 17.xii.1985, 1 ♀ (RMNH), same data but 13—17.xii.1985, 1 ♀ (RMNH); Marena, Hihia, 400 m, 10 km N Gimpu, ML-light, 20.iii.1985, J. P. & M. J. Duffels, 1 ♀ (ZMA).

Etymology. — The species is named *incisa*, because it is the only species within the *foliata* group with an incised apex of the aedeagus.

#### Remarks.

Though pigmented alike *L. mirandae* and *L. majuscula*, *L. incisa* has some features that remind of other species. The weakly sclerotized aedeagal appendage is reminiscent of that of *L. foliata* and related species, whilst the claspers are alike the ones of *L. pectinulata*. Finally, the flat enlargement in the male genitalia is hardly developed, suggesting being more similar to the species of the *distanti* subgroup, that have no enlargement at all.

This small species is recorded from an altitude between 400—600 m. The larger *L. mirandae* is recorded from 1600 m, and the largest pigmented species, *L. majuscula*, is from 1900 m. This feature, that within a small assemblage of, probably, closely related species, the body size increases when taken at an higher altitude, is also displayed when comparing *L. minahassae*, *L. elongata* and *L. dekkeri*, and for *L. hollowayi* and *L. oligorbanta*. Whether this feature is also displayed in other species-groups of the Prasiini, or even in other Cicadoidea, is under study.

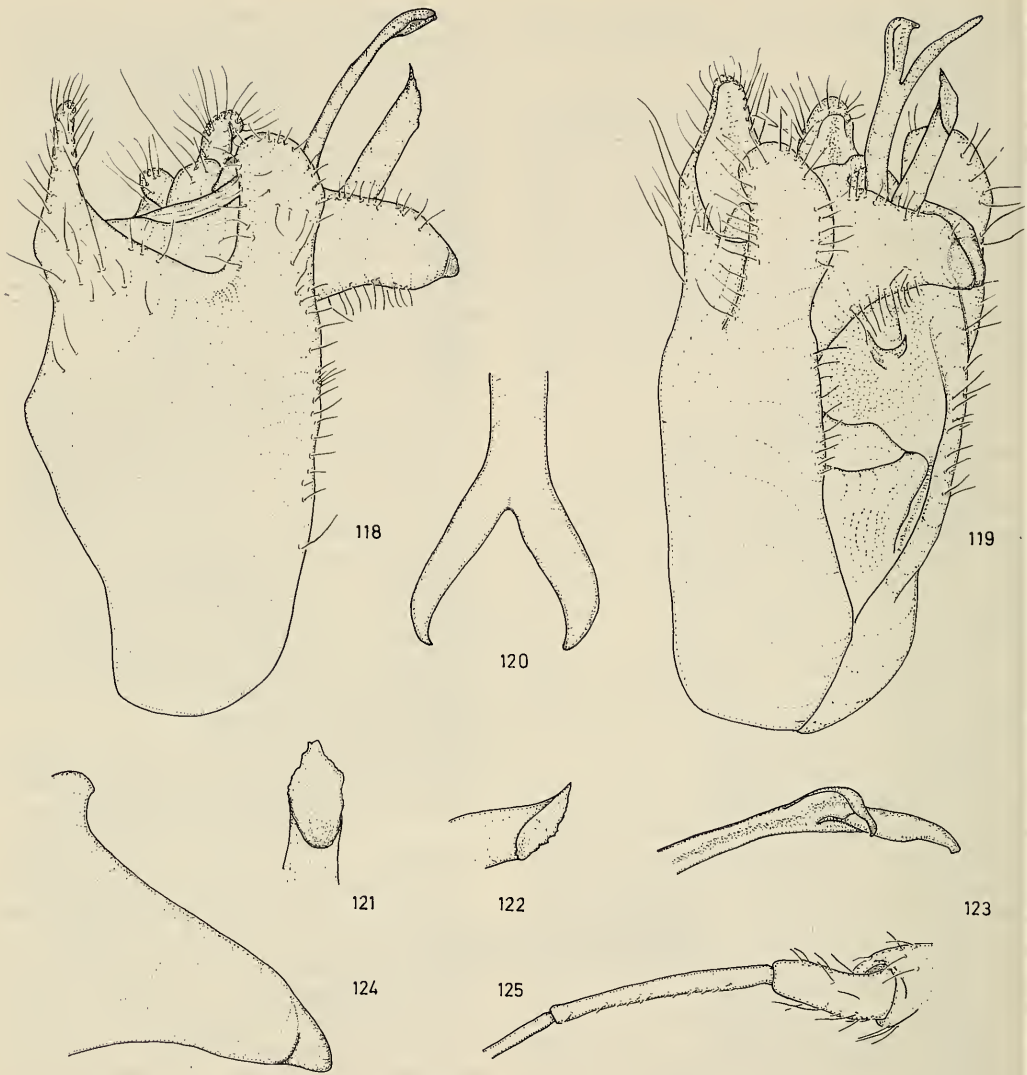

Figs. 118—125. *Lembeja distante*, holotype. 118, 119, pygofer, 118, lateral view, 119, ventrolateral view; 120, apex of aedeagal appendage, dorsal view; 121, 122, apex of aedeagus, 121, ventral view, 122, ventrolateral view; 123, apex of aedeagal appendage, ventrolateral view; 124, clasper, lateral view; 125, left antenna segm. 1—4, lateral view.

#### The *distante* subgroup

Within the *foliata* group as a whole, the *distante* subgroup can be recognized by the almost complete lacking of the antennal combs. Furthermore, eyes medium-sized,  $0.56\text{--}0.75 \times$  width of vertex between eyes. Fore femora with 2nd spine from base (homologous to middle thorn in other *Prasiini*) relatively large. Male

tergite 1 depressed distally at both sides of triangular-shaped bulb. Opaque tegmina pigmented with minute punctations in cells of the tegmina. Spots along veins brown. Sclerotized aedeagal appendage with hook-shaped apex. Lateral lobe bulbous. Ovipositor sheath extending not far beyond caudal dorsal beak.



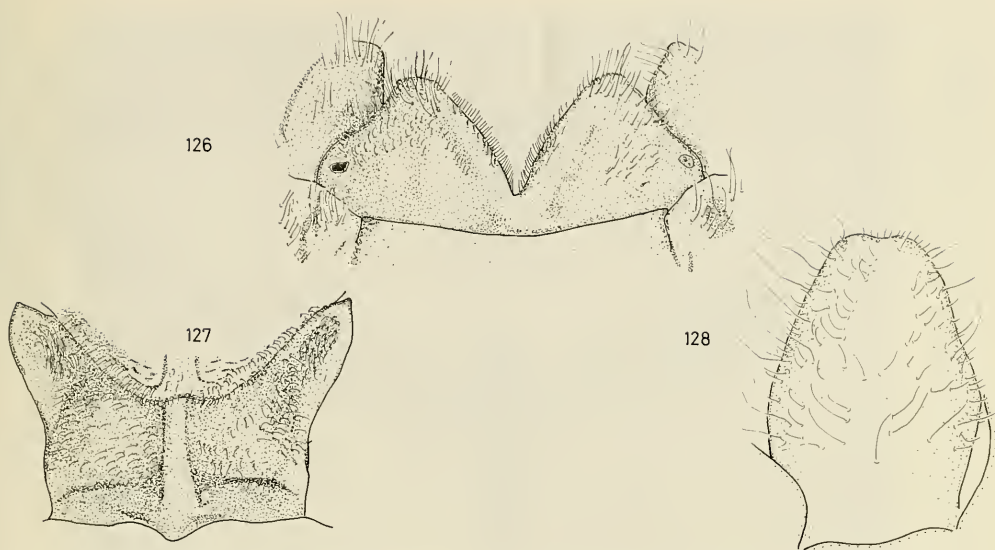

Figs. 126—128. *Lembeja distanti*; 126, ♀, paratype; 127, 128, holotype. 126, sternite 7, ventral view; 127, tergite 1, dorsal view; 128, sternite 8, ventral view.

***Lembeja distanti* n.sp.**  
(figs. 118—128, map 1)

The species is described after three males and two females.

**Description.**

Dull brownish testaceous to sometimes reddish in females. Ventrally paler. Head and pronotum together  $0.95\text{--}1.04 \times$  as long as meso- and metanotum together. Head and thorax together in males  $0.88 \times$ , in females  $1.07 \times$  as long as abdomen. Greatest width of body at the height of abdominal segment 3.

**Head.** — Antennal comb on segment 3 sometimes only scarcely discernable. Eye large, in dorsal view  $0.62\text{--}0.65 \times$  as wide as width of vertex between eyes. Ocelli raised. Distance between lateral ocelli  $0.82\text{--}0.97 \times$  distance between lateral ocellus and eye. Head  $1.41\text{--}1.72 \times$  as long,  $2.24\text{--}2.42 \times$  as wide as width of vertex between eyes. Upper portion of postclypeus in lateral view slightly darker coloured. Rostrum with dark apex reaching trochanter of middle leg.

**Thorax.** — Pronotum with some dark-brown patches. Pronotum collar  $1.60\text{--}1.74 \times$  as wide as width of head,  $2.26\text{--}2.73 \times$  as wide as length of head. Central fascia slightly reddish. Mesonotum mottled within 4 obconical areas.

**Legs.** — Concolorous with ventral side of thorax. Fore and middle tibiae darkening towards claws, and with somewhat darker spots at their bases and apices. Fore femora with 4—5 spines: a basal long, rounded and apically pointed one, the following, pointed one (the so-called middle thorn in other Prasiini) very sturdy, which is followed by 2—3 gradually smaller, pointed thorns.

**Tegmina and wings.** — Tegmina subhyaline with a high number of small red punctations, combined irregularly to smaller and larger patches within the cells of the tegmina, and to more regular patches along the veins. Transverse vein of 2nd ulnar area extending just into the 3rd one; continued by a fold. Node halfway  $M_{3+4}$  distinct. Extreme base whitish to pink. Third ulnar area  $0.97\text{--}1.08 \times$  as long as 1st one; 4th ulnar area  $1.08\text{--}1.25 \times$  as long as radial one. Wings with red to white veins. Fusion of  $Cu_2$  and  $A_1$  at 88—95% from their origin.

**Male: Operculum.** — Small, meracanthus reaching over tymbal cavity.

**Abdomen.** — Broad. Tergite 1 strongly depressed distally at both sides of triangular shaped bulb. Sternite 8 broad, posterior margin almost straight.

**Tymbals.** — Fourteen to 15 long ridges alternating with an equal number of short ridges.

**Genitalia.** — Apically pointed caudal dorsal

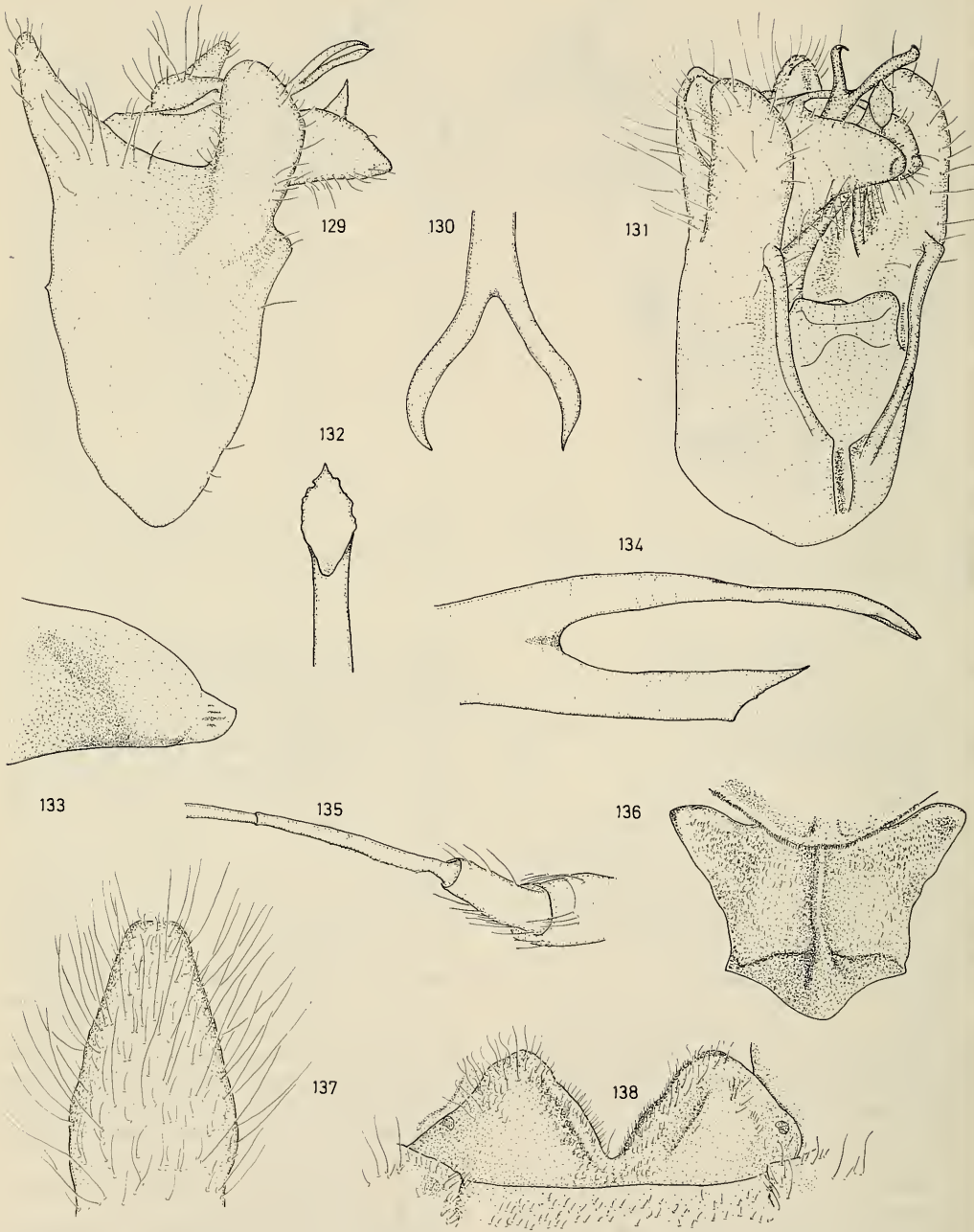

Figs. 129—138. *Lembeja brendelli*; 129—137, ♂, Ranu River Area; 138, ♀ paratype Ranu River Area. 129, pygofer, lateral view, paratype; 130, apex of aedeagal appendage, dorsal view, holotype; 131, pygofer, ventrolateral view, paratype; 132, apex of aedeagus, ventral view, holotype; 133, clasper, lateral view, paratype; 134, aedeagus with appendage, lateral view, holotype; 135, left antenna, segm. 1—4, lateral view, paratype; 136, tergite 1, dorsal view, holotype; 137, sternite 8, ventral view, paratype; 138, sternite 7, ventral view.

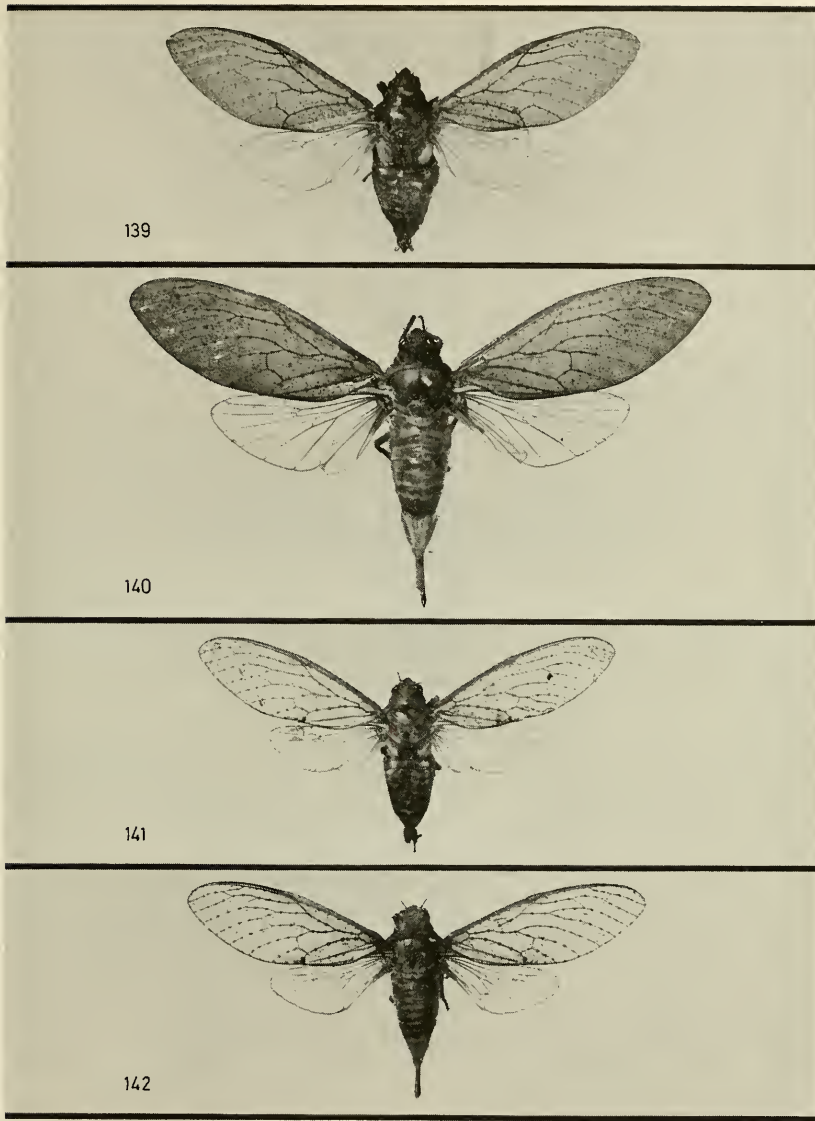

Figs. 139—142. General facies. 139, *Lembeja minabassae* ♂, paratype Toraut; 140, *Lembeja minabassae* ♀, paratype Edwards Camp; 141, *Lembeja hollowayi* ♂, paratype Toraut; 142, *Lembeja hollowayi* ♀, paratype Toraut.



beak extending not or just beyond anal valves. Lateral lobes in lateral view apically slightly recurved. Edge running downwards from lateral lobe to base of pygofer straight. Claspers in lateral view straight, nail-shaped protrusion medium-sized. Aedeagus apically with a slightly upcurved tooth. Dorsal aedeagal appendage apically with more or less flattened hook-shaped processes. Adjustment of aedeagus situated halfway pygofer lobe. Base of pygofer medially incised.

Female: Operculum. — Small, meracanthus just reaching sternite 3.

Abdomen. — Dorsally carinated. Segment 9 dorsally somewhat darker coloured. Ovipositor sheath  $0.33 \times$  as long as abdomen.

Measurements of the types: body length  $\delta$ : 19.7 mm (n = 1),  $\text{♀}$ : 18.4 mm (n = 1); width of pronotum collar  $\delta$ : 5.8–6.7 mm,  $\text{♀}$ : 6.6 mm; tegmen length  $\delta$ : 24.4 mm (n = 1),  $\text{♀}$ : 22.7–22.8 mm.

Distribution. — Central and South-East Sulawesi (map 1).

Types. — Indonesia, Sulawesi: Holotype: "Celebes/Posso See/II 95 Sarasin" (handwritten), "Celebes/Posso See/Sarasins" (yellow label, handwritten), "1910/6" (partly print, partly handwritten), "coll. JACOBI" (print), "Staatl. Museum für Tierkunde Dresden" (print), 1  $\delta$  (SMD). Paratypes: Indonesia, Sulawesi: Kandari (= Kendari?), iv.1874, O. Beccari, *Perissoneura maculosa*, 1  $\delta$  (MSNG); Posso See, ii.95, Sarasin, *Lembeja sanguinolenta* Jacobi det, coll. Breddin, 1  $\delta$  (DEI), same data but: *sanguinolenta*,  $\text{♀}$ , coll. Breddin, 1  $\text{♀}$  (DEI). Specimen without precise indication of locality: Celebes, 1  $\text{♀}$  (SMD).

Etymology. — The species is named after W. L. Distant, one of the greatest contributors to the knowledge on the Cicadoidea, primarily concerned with the taxonomy of several insect groups, among which the superfamily Cicadoidea. Furthermore, he is the author of the genus accommodating the species described in this publication (Distant, 1883, 1892).

#### Remarks.

*L. distanti* and *L. brendelli* n.sp. are very similar in their male genitalia structures. Characters of distinction will be discussed in the remarks on *L. brendelli* n.sp.

#### *Lembeja brendelli* n.sp.

(figs. 129–138, 145, 146, map 1)

The species is described, in comparison with

*L. distanti*, after a fine series of male and female specimens collected by Mr M. J. D. Brendell (BM) during "Operation Drake" in Sulawesi Tengah in 1980.

#### Description.

Brownish ochraceous, sometimes reddish in females; pronotum and abdomen lighter coloured. Ventrally paler than dorsally. Head and pronotum together  $0.93\text{--}1.19 \times$  as long as meso- and metanotum together. Head and thorax together in males  $0.71\text{--}0.87 \times$ , in females  $0.77\text{--}1.09 \times$  as long as abdomen. Greatest width of body at the height of abdominal segment 3.

Head. — Mostly dark-coloured. Antennal comb may be hardly discernable by some hairs on the 3rd segment. Eye large,  $0.56\text{--}0.75 \times$  as wide as width of vertex between eyes. Ocelli raised; distance between lateral ocelli  $1.0\text{--}1.6 \times$  distance between lateral ocellus and eye. Head  $1.33\text{--}1.76 \times$  as long,  $2.12\text{--}2.49 \times$  as wide as width of vertex. Postclypeus in ventral view medially slightly to considerably darker. Rostrum with dark apex reaching trochanter of middle leg.

Thorax. — Pronotum with dark-coloured patches as in *L. distanti*. The central fascia on the pronotum usually dark-coloured and continues on pronotum collar. Lateral corners of pronotum collar mostly with dark patches. Pronotum collar  $1.48\text{--}1.72 \times$  as wide as width of head,  $2.08\text{--}2.81 \times$  as wide as length of head. Obconical areas on mesonotum sometimes lighter, sometimes darker than ground colour. Cruciform elevation with a medial longitudinal dark line, which continues on the metanotum.

Legs. — Generally as in *L. distanti*, though fore and middle legs on the whole darker tinged. Arrangement of the 4, dark-coloured spines on the fore femora as in *L. distanti*; most apical one very small.

Tegmina and wings. — Subhyaline, especially in females with a high number of small red punctations, that are combined to very large, almost tegmencell-filling, patches; also dark-red to brownish tinged small spots present, as well in the cells of the tegmina as along the veins. Extreme base pink to whitish. Transverse vein of 2nd ulnar area extending just to reasonably into the 3rd ulnar area, continued by a fold. Third ulnar area  $0.76\text{--}1.01 \times$  as long as 1st one; 4th ulnar area  $1.15\text{--}1.5 \times$  as long as radial area. Wings sometimes tinged basally with pink, extreme base pink to whitish. Fusion of  $\text{Cu}_2$  and



143



144



145



146

Figs. 143—146. General facies. 143, *Lembeja majuscula* ♂, holotype; 144, *Lembeja majuscula* ♀, paratype; 145, *Lembeja brendelli* ♂, paratype; 146, *Lembeja brendelli* ♀, paratype Ranu River area.

A<sub>1</sub> at 85—98% from their origin.

Male: Operculum. — Small. Meracanthus reaching just over tymbal cavity.

Abdomen. — More slender than in *L. distanti*, triangular light-brown to ochraceous. Tergite 1 strongly depressed distally on both sides of the triangular shaped bulb; ridge sometimes slightly darker coloured. Sternite 8 broad, sometimes narrowing apically.

Tymbals. — Provided with 17—20 long ridges alternating with 16—20 short ridges.

Genitalia. — Generally as in *L. distanti*, but with the following differences: claspers less elongate; edge running downwards from each lateral lobe to base of pygofer with a distinct protrusion just under lateral lobe; lateral lobe more bulbous subapically; apex of aedeagus weakly upcurved; sclerotized processes aedeagal appendage round, slender and pointed.

Female: Operculum. — Relatively larger than in *L. distanti*. Meracanthus just reaching sternite 3.

Abdomen. — Reddish or brownish coloured with dark mark on segment 9. Ovipositor sheath 0.24—0.32 × as long as abdomen.

Measurements of the types: body length ♂: 16.8—19.2 mm,  $\bar{x}$  = 17.6 ± 0.8 mm, ♀: 16.2—20.8 mm,  $\bar{x}$  = 18.5 ± 1.3 mm; width of pronotum collar ♂: 5.5—6.8 mm,  $\bar{x}$  = 6.0 ± 0.4 mm, ♀: 5.9—7.5 mm,  $\bar{x}$  = 6.9 ± 0.9 mm; tegmen length ♂: 19.4—20.2 mm,  $\bar{x}$  = 19.8 ± 0.3 mm, ♀: 20.4—24.6 mm,  $\bar{x}$  = 22.7 ± 0.9 mm.

Distribution. — Central Sulawesi (map 1).

Types. — Indonesia, Sulawesi: Holotype: "Sulawesi Tengah:/Nr Morowali/Ranu River Area/27.i.—20.iv.1980" (print), "M. J. D. Brendell/B.M. 1980-280" (print), "Brit. Mus." (partly print, partly handwritten), 1 ♂ (BMNH). Paratypes: Indonesia, Sulawesi Tengah: same data as holotype, 4 ♂ 14 ♀ (BMNH), 3 ♂ 3 ♀ (ZMA), same data but: at light, lowl. rainf., 8 ♀ (BMNH), same data but: at MV light lowl. rainf., 3 ♀ (BMNH), same data but: lowl. rainf., 1 ♀ (BMNH); Solato R., Taronggo, 1°45'S—121°40'E, 27—30.iii.1980, M. J. D. Brendell, BM 1980-280, 1 ♀ (BMNH).

Etmology. — The species is named after the British coleopterist Mr Martin J. D. Brendell (BMNH), who has collected the series of speci-

mens, upon which the description of this species is based.

#### Remarks.

*L. brendelli* can be separated from *L. distanti* by male genital characters, viz. the clearly out-curved edge running downwards from each lateral lobe to base of pygofer, the rounded, pointed processes of the dorsal aedeagal appendage and by the different number of long ridges on the tymbal. The very depressed distal parts of the male tergite 1 may be a synapomorphy for both species of the *distanti* subgroup.

#### REFERENCES

The list presented here is additional to the references of Part 1 of the study: "Taxonomy and biogeography of Oriental Prasiini" (De Jong, 1985).

- Boulard, M., 1975. *Iruana rougeoti* n.sp. intéressante cigale éthiopienne. — Bull. Soc. ent. Fr. 80: 176—179, figs. 1—2.
- Boulard, M., 1981. Recherches zoologiques en Ethiopie: Homoptera Cicadoidea. — Quad. Accad. Naz. Lincei, Roma 243: 57—60, figs. 1—8.
- Distant, W. L., 1897a. Cicadidae from the Malay Archipelago. — Ann. Mag. nat. Hist. (6) 20: 369—371.
- Distant, W. L., 1897b. Viaggio di Lamberto Loria nella Papuasie orientale xvii. Additions to our knowledge of the Cicadidae of New Guinea. — Annali Mus. civ. Stor. nat. Giacomo Doria (2) 17: 378—383.
- Jong, M. R. de, 1985. Taxonomy and biogeography of Oriental Prasiini 1: The genus *Prasia* Stål, 1863 (Homoptera, Tibicinidae). — Tijdschr. Ent. 128 (2): 165—191, figs. 1—91.
- Lallemand, V., 1935. Homoptères des Îles de la Sonde et de l'Australie du Nord. — Revue Suisse Zool. 42: 661—668, figs. 1—19.
- Lallemand, V. & H. Synave, 1953. Homoptères de Sumba et de Florès. In: Wissenschaftliche Ergebnisse der Sumba-Expedition des Museums für Völkerkunde und des Naturhistorischen Museums in Basel, 1949. — Verh. naturf. Ges. Basel 64: 903—912, figs. 1—2.

(Author's address: Institute of Taxonomic Zoology, University of Amsterdam, P.O. Box 20125, 1000 HC Amsterdam, The Netherlands.)







QL  
461  
T568  
Ent.

# TIJDSCHRIFT VOOR ENTOMOLOGIE



UITGEGEVEN DOOR

DE NEDERLANDSE ENTOMOLOGISCHE VERENIGING



## INHOUD

A. J. DAVIS. — Bibliography of the Ixodiphagini (Hymenoptera, Chalcidoidea, Encyrtidae), parasites of ticks (Acari, Ixodidae), with notes on their biology, pp. 181—190, figs. 1, 2.





**BIBLIOGRAPHY OF THE IXODIPHAGINI  
(HYMENOPTERA, CHALCIDOIDEA, ENCYRTIDAE),  
PARASITES OF TICKS (ACARI, IXODIDAE), WITH NOTES  
ON THEIR BIOLOGY**

by

A. J. DAVIS

*Afdeling Oecologie, Subfaculteit Biologie, Rijksuniversiteit Leiden, Nederland*

**ABSTRACT**

A bibliography is presented of the Ixodiphagini, poorly known specialist parasitoids of ixodid ticks. Their larvae develop in the host, largely on vertebrate blood. Notes are given on the taxonomy of the group and their occurrence in Europe. Their biology is described.

**INTRODUCTION**

The Ixodiphagini are a small tribe of morphologically unremarkable Encyrtids (figs. 1 and 2). Unlike other Encyrtids, however, they are internal parasites of hard ticks (Acari : Ixodidae). Several hymenopteran families contain species that parasitize arthropods that are not insects, but the Ixodiphagini are unusual because their larvae consume the vertebrate blood ingested by the host tick. This diet is unique among the parasitic Chalcidoidea.

Tick physiology and ecology are different from those of insects and the ixodiphagine acaroparasitoids show interesting adaptations to their tick hosts. Because the group is not well known, and the literature is scattered and difficult to trace, these notes and bibliography are offered as a stimulus to new research.

**TAXONOMY AND BIOLOGY**

There are currently seven species named in the Ixodiphagini, all of which are now assigned to the genus *Ixodiphagus* Howard, 1907 (Trjapitzin, 1985). Formerly they were separated into the genera *Ixodiphagus* and *Hunterellus* Howard, 1908 (Gahan, 1934; Quaraishi, 1958). The present species names probably conceal considerable diversity. Morphological and behavioural differences exist between *I. texanus* Howard, 1907 populations from the United States of America (Bowman, 1979), and from Canada (Davis and Campbell, 1979). Similar differences are recorded among the Indian *I. bookeri* (Howard, 1908) (Geevarghese and Dhanda, 1983), and European *I. bookeri* may

differ from American representatives of the species.

Species are known from all zoological regions (Cole, 1965; Noyes and Hayat, 1984; Trjapitzin and Gordh, 1978). Only one species, *I. bookeri*, is recorded from Europe: from Britain (Burt, 1943; Noyes, 1977), Czechoslovakia (Boucek and Cerny, 1954), France (Brumpt, 1930; Du Buysson, 1912), and the Soviet Union (Nikolskaya, 1952). The African species *I. theilerae* (Fielder, 1953), however, has been collected in Egypt on birds migrating to Europe (Kaiser and Hoogstraal, 1958; Hoogstraal and Kaiser, 1961). This species therefore may occasionally enter Europe.

The behaviour of the Ixodiphagini has been little studied except in the two American species *I. bookeri* and *I. texanus*. Least well known is how the female parasites find their hosts. Females have been seen in the fur of animals (Philip, 1931). They may therefore first search for the prey animal of the tick. The ticks would then be found and parasitized whilst they were still attached. All the ixodiphagines studied are able to oviposit in recently detached fully fed ticks. *I. bookeri* from the western U.S.A. (Coolcy and Kohls, 1928), and from France (Brumpt, 1930), will also oviposit in unattached unfed hosts.

The host ranges of the Ixodiphagini are unknown. Taxonomic uncertainty among the parasitoids obscures the true acceptability of tick species as hosts for particular ixodiphagines. Some host specificity exists among the Indian species (Geevarghese and Dhanda, 1983). In

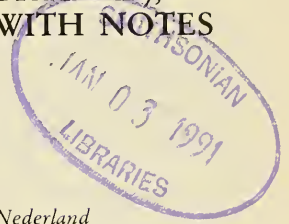

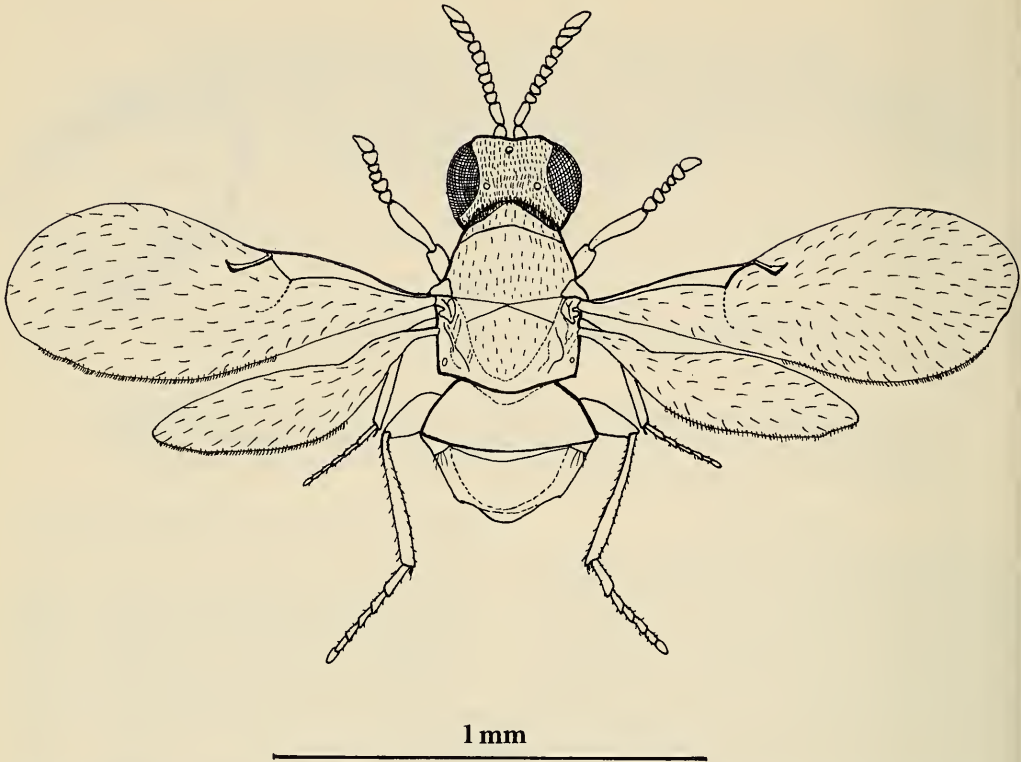

Fig. 1. *Ixodiphagus bookeri* (Howard, 1908), female from Czechoslovakia. Redrawn after Boucek and Cerny, 1954.

Nova Scotia, Canada, *I. texanus* emerged from only one of several tick species collected in the field. In the laboratory I was unable to obtain parasitization of any additional potential host species. Females of this strain of *I. texanus* have a complex sequence of host acceptance behaviour. They begin the sequence by antennating any rounded object, but oviposition is only completed on fully fed larvae and nymphs of one species. In Oklahoma, U.S.A., however, the same species parasitizes several tick species (Bowman, 1979).

The Ixodiphagini are not known to oviposit in adult ticks, whether these are fed or unfed, and most identified species oviposit and develop only in the nymphal stage of the host. *I. texanus* in Canada develops in fully fed larvae as well as nymphs (Davis and Campbell, 1979). In the U.S.A. the same species will also oviposit in unfed nymphs (Bowman, 1979). *I. bookeri* oviposits in fed and unfed larval and nymphal hosts, but development only occurs in the fully

fed nymphs. This behaviour is known for material from Europe (Brumpt, 1930) and from America (Cooley and Kohls, 1934).

Several eggs are laid during a single oviposition and the larvae develop gregariously. In the laboratory there is no apparent obstacle to simultaneous or subsequent superparasitism.

After detaching from its prey the tick enters the ground litter. At this stage apolysis occurs in the tick and this may stimulate hatching, or development, of the parasites. As the ixodiphagine larvae grow the external appearance of the tick shows characteristic changes (Wood, 1911). The duration of larval life depends on temperature, and on whether or not the tick diapauses.

Adult parasitoids usually emerge from a single hole chewed at the rear of the tick (Davis and Campbell, 1979) where the cuticle is thinnest. Males tend to emerge first and copulation takes place near the host remains. Females disperse rapidly after mating.

More adults emerge from large than from small hosts, although adult size appears to be



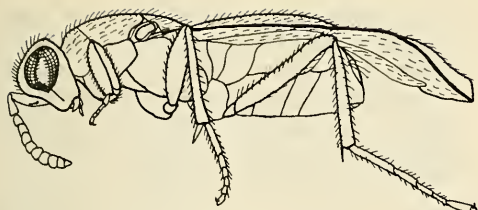

1 mm

Fig. 2. *Ixodiphagus hirtus* Nikolskaya, 1950, female from the Far Eastern U.S.S.R. Redrawn from Trjapitzin, 1985.

negatively correlated with brood size. Broods from large hosts have, in general, a lower proportion of males. These relationships exist in one species, *I. texanus* (Dean, 1982), and also appear to hold across the Ixodiphagini as a whole.

#### NOTES

This bibliography contains over 135 publications on the genera *Ixodiphagus* and *Hunterellus*, all members of which are internal gregarious parasitoids of ticks (Acari, Ixodidae).

The publications are listed alphabetically by author and each entry includes the full title, full journal title and pagination. Where the article contains a large number of pages, those referring directly to the Ixodiphagini are listed in parentheses immediately after the full reference. In square brackets after each entry is given the original language of the article followed by the language of any translation in my possession. The initials AUIC indicate translations made under my auspices and the number following them is the index number of the translation in my collection. NAMRU3 refers to translations made, or held, by the Medical Zoology Department, American Naval Medical Unit Number 3, Embassy of the United States of America, Cairo, Egypt. It is followed by the number referencing the translation in their library. Where both an AUIC and a NAMRU3 translation are listed, they both usually originate from AUIC.

I have not been able to obtain copies, or trace the whereabouts, of those entries preceded by an asterisk (\*).

#### ACKNOWLEDGEMENTS

I wish to thank the many colleagues and correspondents who have helped to discover, obtain, and in some cases, translate, the articles listed.

The Bibliography was initially compiled in 1985 during my stay as a visiting researcher at the Rijksuniversiteit Leiden in the Netherlands, using facilities generously made available by the Ecology Department of the Subfaculty of Biology.

M. Wilbraham and J. Law prepared the figures.

#### IXODIPHAGINI

Alfeev, N. I., 1940. The utilization of *Hunterellus hookeri* How. for the control of the ticks *Ixodes ricinus* L. and *Ixodes persulcatus* P.Sch. with reference to the peculiarities of their metamorphosis under the conditions of the province of Leningrad. — In: Second Conference on Parasitological Problems, Leningrad November 1940. Ed. E. N. Pavlovsky. Izdatelstvo Akademii Nauk CCCP: 23-25. [Russian]. — Abstracted: 1946, Review of Applied Entomology, Series B, 34: 108-109. [English]

Alfeev, N. I., and Ya. V. Klimas, 1938. An experiment in cultivating ichneumon flies, *Hunterellus hookeri*, imported from the USA, which destroy ticks of the family Ixodidae of our fauna. — Priroda 2: 98-101. [Russian, English AUIC:11, NAMRU3:T1674]

Alfeev, N. I., and Ya. V. Klimas, 1938. On the possibility of developing ichneumon flies *Hunterellus hookeri* in the climatic conditions of the USSR. — Sovetskiya Veterinariya, 3: 55. [Russian, English AUIC:4, NAMRU3:T1676]

Annecke, D. P., and H. P. Insley, 1971. Catalogue of Ethiopian Encyrtidae and Aphelinidae (Hymenoptera: Chalcidoidea). — Entomology Memoir. Department of agricultural technical Services, Republic of South Africa 23: 1-53 (14,38). [English]

Anonymous, 1936. Entomological Branch: Other investigations and activities. — Annual Report, Canadian Department of Agriculture (1935-1936): 83. [English]

- Anonymous, (after 1965). Introduced parasites and predators of arthropod pests and weeds. — Agricultural Handbook, United States Department of Agriculture 480: 1-545 (2-3). [English]
- Babenko, L. V., 1969. Parasitic insects as one of the causes of ixodid tick death. — Prirodnouchagoviye bolezni Urala Sibiri i Dalnego Vostoka: 84-89. [Russian]
- Bequaert, J., 1930. Ticks collected by the American Museum Congo Expedition 1909-1915, with notes on the parasites and predacious enemies of these arthropods. — American Museum Novitates 426: 1-12. [English]
- Bequaert, J. C., 1945. The ticks, or Ixodoidea, of the Northeastern United States and Canada. — Entomologia Americana 25(2): 74-201 (117,150,198). [English]
- Bernadskaya, Z. M., 1936. A case of parasitism in Ixodid ticks. — Trudy uzbekskoj nauchno issledovatel'skoj veterinarnij opitnoj stanzii. Narkom, Uzbek CCP 11(2): 28-30. [Russian, English AUC:10, NAMRU3:T1686]
- Bishopp, F. C., 1934. Records of hymenopterous parasites of ticks in the United States. — Proceedings of the Entomological Society of Washington 36(4): 87-88. [English]
- Bishopp, F. C., 1934. Minutes of the 458th regular meeting of the Entomological Society of Washington, Oct 4 1934. — Proceedings of the Entomological Society of Washington 36(8-9): 262-263. [English]
- Bishopp, F. C., and C. N. Smith, 1938. The American dog tick, eastern carrier of Rocky Mountain Spotted Fever. — Circular, United States Department of Agriculture 478: 1-25 (23). [English]
- Blagoveschensky, D. I., 1940. Hymenopterous parasites of ixodid ticks. — In: Second Conference on Parasitological Problems, Leningrad, November 1940. Ed. E. N. Pavlosky. Izdatel'stvo Akademii Nauk CCCP: 23. [Russian]
- Blagoveschensky, D. I., 1947. Hymenopteran parasites of ticks of the family Ixodidae. — Parasitologicheskij Sbornik Zoologicheskii Institut Akademii Nauk CCCP 9: 115-124. [Russian, English AUC:7, NAMRU3:T1681]
- Blanc, G., E. Goiran, and M. Baltazard, 1937. Observations de deux cas de fièvre boutonneuse à Conakry (Guinée Française) et découverte, chez les Rhipicephales de la région du chalcidien parasite *Hunterellus hookeri*. — Archives de l'Institut Pasteur du Maroc 1(4): 667-675. [French]
- Boucek, Z., and V. Cerny, 1954. Cizopasník Kiistat Chalcidka *Hunterellus hookeri* How. v CSR. — Zoologické a Entomologické listy, Folia Zoologica et Entomologica 3(2): 109-111. [Czech, English AUC:1, NAMRU3:T1685]
- Bowman, J. L., 1979. Host suitability and laboratory biology of *Ixodiphagus texanus* Howard. — Unpublished MSc Thesis, Oklahoma State University, Stillwater, Oklahoma, USA. [English]
- Brumpt, E., 1913. Utilisation des insectes auxiliaires entomophages dans la lutte contre les insectes pathogènes. — La Presse Médicale 36: 359-361. [French]
- Brumpt, E., 1930. Parasitisme latent de *Ixodiphagus caurcei* chez les larves gorgées et les nymphes à jeun de divers ixodines (*Ixodes ricinus* et *Rhipicephalus sanguineus*). — Comptes rendus de l'Académie des sciences de Paris 191(12): 1085-1087. [French]
- Burton, W. E., 1936. Beware the tick. — Hygeia 14: 324-328. [English]
- Burt, E. T., 1943. The occurrence of the tick parasite *Ixodiphagus texanus* du Buysson (Hymenoptera; Chalcidoidea; Fam. Encyrtidae) in Great Britain. — Proceedings of the Royal Entomological Society of London, Series A. General Entomology 18: 28-29. [English]
- Clausen, C. P., 1940. Entomophagous Insects. — McGraw-Hill Book Co. Inc. New York: 169-188. [English]
- Clausen, C. P., 1956. Biological control of insect pests in the continental United States. — Technical Bulletin, United States Department of Agriculture 1139: 1-143 (72). [English]
- Cobb, S., 1942. Tick parasites on Cape Cod. — Science 95(2472): 503. [English]

- Cole, M. M., 1965. Biological control of ticks by the use of hymenopterous insects. A review. — World Health Organization (WHO/EBL/43.66) 43: 1-12. [English]
- Cooley, R. A., 1926. Notes on medical entomology. — *Journal of Economic Entomology* 19: 810. [English]
- Cooley, R. A., 1927. A parasite of ticks. — *Biennial Report, Montana State Board of Entomology* 6: 15-17. [English]
- Cooley, R. A., 1927. Tick Parasites. — *The Medical Sentinel* 35(12): 805-815. [English]
- Cooley, R. A., 1928. Montana's laboratory for the study of insect borne diseases. — *American Journal of Public Health* 18: 993-996. [English]
- Cooley, R. A., 1929. Tick parasites - Executive Report. — *Biennial Report, Montana State Board of Entomology* 7: 10-16. [English]
- Cooley, R. A., 1929. Preliminary report on the tick parasite *Ixodiphagus caururtei* du Buysson. — *Biennial Report, Montana State Board of Entomology* 7: 17-31. [English]
- Cooley, R. A., 1929. A summary of tick parasite studies. — *South African Journal of Natural History* 6: 266-272. [English]
- Cooley, R. A., 1930. The Montana tick parasite expedition to Africa. — *Science* 71(1842): 419-420. [English]
- Cooley, R. A., 1931. Review of tick parasite work for 1929 and 1930. — *Biennial Report, Montana State Board of Entomology* 8: 16-25. [English]
- Cooley, R. A., 1931. Tick parasites in Africa. — *Biennial Report, Montana State Board of Entomology* 8: 26-34. [English]
- Cooley, R. A., 1932. The Rocky Mountain Wood Tick. — *Bulletin of the Montana Agricultural Experiment Station* 268: 1-58 (54-55). [English]
- Cooley, R. A., 1933. Observations sur *Ixodiphagus caururtei* du Buysson dans l'ouest des Etats-Unis. — *Annales Parasitologie Humaine et Comparative* 11(1): 22-23. [French]
- Cooley, R. A., 1934. A search for tick parasites in South Africa. — *Onderstepoort Journal of Veterinary Research* 3(1): 23-42. [English]
- Cooley, R. A., 1934. Occurrence of tick parasites in nature in southern Idaho. — *Report, United States Public Health Service* 49(4): 111-112. [English]
- Cooley, R. A., and G. M. Kohls, 1928. Egg laying of *Ixodiphagus caururtei* du Buysson in fed larval ticks. — *Science* 67(1748): 656. [English]
- \* Cooley, R. A., and G. M. Kohls, 1930. The possibility of controlling the Wood tick by parasites. — *Western Hospital News* 2(1): 8. [English]
- Cooley, R. A., and G. M. Kohls, 1934. A summary of tick parasites. — *Proceedings of the Fifth Pacific Science Congress 1933*, 5: 3375-3381. [English]
- Da Costa Lima, A., 1915. The chalcid *Hunterellus bookeri* Howard parasitizing the tick *Rhipicephalus sanguineus* Latreille, observed in Rio de Janeiro. — *Revista de veterinaria e zootechnia* 1915: 201-203. [Portuguese, English AUC:2, NAMRU3:T1668]
- Davis, A. J., 1978. A review of available information on Encyrtid parasites of ticks, including some data from studies in southwestern Nova Scotia. — Unpublished manuscript. [English]
- Davis, A. J., and A. Campbell, 1979. *Ixodiphagus texanus* Howard (Hymenoptera: Encyrtidae), a parasite of the rabbit tick in Nova Scotia. — *Canadian Journal of Zoology* 57(5): 1164-1166. [English]
- Dean, R., 1982. The relationship between the size of the host and the resultant brood size, sex ratio, and the size of emerging individuals in two parasitic Hymenoptera, *Ixodiphagus texanus* Howard, and *Nasonia vitripennis* (Walker). — Unpublished BSc Thesis, University of Wales. Cardiff, Wales, United Kingdom. [English]
- De Santis, L., 1963. Encirtidos de la Republica Argentina. (Hymenoptera : Chalcidoidea). — *Anales de la Comision de investigacion cientifica* 4: 9-422 (22-23,27,31,35). [Spanish]
- Doube, B. M., and A. C. G. Heath, 1975. Observations on the biology and seasonal abundance of an encyrtid wasp, a parasite of ticks in Queensland. — *Journal of Medical Entomology* 12(4): 443-447. [English]



- Du Buysson, R., 1912. Un Hyménoptère parasite des Ixodes. — Archives de Parasitologie 15: 246-247. [French]
- Erdoes, J., 1956. Chalcidoidea nova in collectione Biroi (Hymenoptera). — Annales historico naturales Musei Nationalis Hungarici 7: 181-194. [Latin]
- Erdoes, J., and S. Novicky, 1955. Genera Encyrtidarum regionis palaearticae. — Beiträge zur Entomologie 5(1-2): 165-202 (176,183,190,194). [Latin]
- Essig, E., 1926. Order Hymenoptera. — Chapter 28. In: Insects of Western North America, Macmillan, New York: 756-907 (842). [English]
- Ferriere, C., 1953. Un nouvel Encyrtide (Hym. Chalcidoidea) de la Guinée Française. — Revue de Pathologie Végétale et d'Entomologie Agricole de France 32(2): 115-119. [French]
- Fielder, O. G. H., 1953. A new African tick parasite *Hunterellus theileri* sp. n. — Onderstepoort Journal of Veterinary Research 26(1): 61-63. [English]
- Flanders, S. E., 1949. Culture of entomophagous insects. — Canadian Entomologist 81(11): 257-274. [English]
- Flanders, S. E., 1949. Culture of entomophagous insects. — Proceedings of the Seventh Pacific Science Congress, Auckland 4: 259-277. [English]
- Gahan, A. B., 1934. On the identities of chalcidoid tick parasites, (Hymenoptera). — Proceedings of the Entomological Society of Washington 36(4): 89-97. [English]
- Gahan, A. B., 1934. Minutes of the 459th regular meeting of the Entomological Society of Washington, Nov 1 1934. — Proceedings of the Entomological Society of Washington 36(8-9): 263-264. [English]
- Geevarghese, G., 1977. A new species of chalcid (Hymenoptera: Encyrtidae) parasitizing *Haemaphysalis bispinosa* from Karnataka, India. — Oriental Insects 11(1): 49-52. [English]
- Geevarghese, G., and M. A. Sreenivasan, 1973. Observations on *Hunterellus* sp. (Hymenoptera: Encyrtidae), parasitizing *Haemaphysalis bispinosa* Neumann 1897 (Acarina: Ixodidae). — Indian Journal of Medical Research 61(7): 992-997. [English]
- Geevarghese, G., and V. Dhanda, 1983. Studies on Indian species of *Hunterellus* (Hymenoptera : Encyrtidae) parasitizing ixodid ticks (Acarina : Ixodidae). — Indian Journal of Parasitology 7(1): 93-95. [English]
- Girault, A. A., 1925. Notes and descriptions of Australian chalcid-flies III. (Hymenoptera). — Insecutor Inscriptiae Menstruus 13(4-6): 91-100 (96-97). [English]
- Graf, J. F., 1979. The biology of an Encyrtid wasp parasitizing ticks in the Ivory Coast. — Recent Advances in Acarology 1: 463-468. [English]
- Green, R. G., C. A. Evans and C. L. Larson, 1943. A ten year population study of the rabbit tick *Haemaphysalis leporis-palustris*. — American Journal of Hygiene 38: 260-281. [English]
- Gregson, J. D., 1942. Notes on the laboratory rearing of some Canadian ticks (Acarina). — Proceedings of the Entomological Society of British Columbia 39: 32-35. [English]
- Hayat, M., 1986. Family Encyrtidae. In: The Chalcidoidea (Insecta : Hymenoptera) of India and the adjacent countries. Part 2, Catalogues. Editors B. R. Subba Rao and M. Hayat. — Oriental Insects 20: 67-138 (104-105). [English]
- Hiregaur, L. S., and B. L. Avasthi, 1966. On *Hunterellus bookeri* Howard a chalcid fly parasitizing nymphs of *Hyalomma anatolicum anatolicum* a common ixodid tick of domestic animals in Gujarat State, India. — Gujvet 1(2): [English]
- Hoffer, A., 1959. Miscellanea Encyrtidologia III. — Acta Entomologica Musei Nationalis Pragae 33: 15-23. [English]
- Hoffer, A., 1963. Descriptions of new species of the family Encyrtidae from Czechoslovakia (Hym. Chalcidoidea) I. — Acta entomologica Musei Nationalis Pragae 35: 549-592 (591-592). [English]
- Hoogstraal, H., 1956. African Ixodidae. I. Ticks of the Sudan, with special reference to Equatoria Province and with preliminary reviews of the genera *Boophilus*, *Margaropus*, and *Hyalomma*. — United States Naval Medical Research Unit No.3 Research Report NM 005 050. 29. 07: 1-1101 (373, 710-713). [English]

- Hoogstraal, H., and M. N. Kaiser, 1961. Records of *Hunterellus theileri* Fielder (Encyrtidae: Chalcidoidea) parasitizing *Hyalomma* ticks on birds migrating through Egypt. — *Annals of the Entomological Society of America* 54(5): 616-617. [English]
- Hoogstraal, H., F. J. Santana and P. F. D. van Peenen, 1968. Ticks (Ixodoidea) of Mt. Sontra, Danang, Republic of Vietnam. — *Annals of the Entomological Society of America* 61(3): 722-729. [English]
- Hooker, W. A., F. C. Bishopp and H. P. Wood, 1912. The life history and bionomics of some North American ticks. — *Bulletin, United States Department of Agriculture Bureau of Entomology* 106: 1-239 (43-44,96,110-111,165). [English]
- Howard, L. O., 1907. A chalcid parasite of a tick. — *Entomological News* 18(9): 374-378. [English]
- Howard, L. O., 1908. Another chalcid parasite of a tick. — *Canadian Entomologist* 40: 239-241. [English]
- Howard, L. O., 1936. Ticks affecting man. — *Annual Reports, United States Department of Agriculture Bureau of Entomology*: 78. [English]
- Howard, L. O., and W. F. Fiske, 1911. The importation into the United States of the parasites of the Gypsy moth and the Brown-tail moth: A report of progress, with some consideration of previous and concurrent efforts of this kind. — *Bulletin, United States Department of Agriculture Bureau of Entomology* 91: 1-316 (41-43). [English]
- Jenkins, D. W., 1964. Pathogens, parasites and predators of medically important arthropods. — *Supplement, Bulletin of the World Health Organisation* 30: 1-150 (81-82). [English]
- Joyce, C. R., and G. W. Eddy, 1943. Hosts and seasonal notes on the rabbit tick *Haemaphysalis leporis-palustris*. — *Iowa State College Journal of Science* 17(2): 205-212. [English]
- Kaiser, M. N., and H. Hoogstraal, 1958. *Hunterellus theileri* Fielder (Encyrtidae: Chalcidoidea) parasitizing an African *Hyalomma* tick on a migrant bird in Egypt. — *Journal of Parasitology* 44(4): 392. [English]
- Kaul, H. N., S. M. Kulkarni, V. Dhanda and G. Geevarghese, 1978. *Hunterellus sagarensis* parasitizing *Haemaphysalis bispinosa* (Acarina: Ixodidae) in Jammu and Kashmir, India. — *Acarology Newsletter, Acarological Society of India* 6: 4-5. [English]
- Klyushkina, E. A., 1958. Finding an ixodid tick parasite *Hunterellus hookeri* How. in the Crimea. — *Medizinskaya Parasitologiya i Parasitarniye Bolenzi* 27(6): 734. [Russian, English AUIIC:9]
- Klyushkina, E. A., 1968. Parasites of Ixodid ticks *Hunterellus hookeri* How. in the Crimea. — *Zoologicheskyy Zhurnal* 37(10): 1561-1563. [Russian, English AUIIC:9]
- Knudson, A. B., D. J. Lewis, R. B. Tesh, A. Rudnick, J. Jeffery and I. Singh, 1978. Phlebotomine sand flies (Diptera: Psychodidae) from a primary hill forest in West Malaysia — *Journal of Medical Entomology* 15(3): 286-291. [English]
- Kohls, G. M., 1931. A summary of parasite liberations. — *Biennial Report, Montana State Board of Entomology* 8: 26-34. [English]
- Larousse, F., A. G. King and S. B. Wolbach, 1928. The over-wintering in Massachusetts of *Ixodiphagus caururtei*. — *Science* 67(1735): 351-353. [English]
- Larson, C. A., 1937. The tick parasite *Ixodiphagus texanus* in nymphs and larvae of *Haemaphysalis leporis-palustris* in Minnesota. — *Journal of Parasitology* 23: 496-498. [English]
- Larson, C. A., and R. G. Green, 1938. Seasonal Distribution of tick parasites. — *Journal of Parasitology* 24: 363-368. [English]
- Lounsbury, C. P., 1909. Parasitic introductions. — *Report of the Government Entomologist for the year 1908, Cape of Good Hope. Appendix IV*: 65. [English]
- MacLeod, J., 1932. The bionomics of *Ixodes ricinus* L., the "Sheep tick" of Scotland. — *Parasitology* 24: 382-400. [English]
- Macleod, J., 1933. Control of the sheep tick on hill pastures. — *Transactions of the Highland and Agricultural Society of Scotland*: 114-127. [English]
- Mani, M. S., 1941. Studies on Indian parasitic hymenoptera I. — *Indian Journal of Entomology* 3(1): 25-36. [English]

- Morton, F. A., 1929. Quantity production of tick parasites. — Biennial Report, Montana State Board of Entomology 7: 32-35. [English]
- Munaf, H. B., 1976. The first record of *Hunterellus bookeri* parasitizing *Rhipicephalus sanguineus* in Indonesia. — South East Asian Journal of Tropical Medicine and Public Health 7(3): 492. [English]
- Nikolskaya, M. N., 1950. New species of parasite of ixodid ticks, *Ixodiphagus hirtus* Nik. sp. n. (Hymenoptera, Chalcidoidea). — Parazitologicheskii sbornik Zoologicheskova instituta Akademii Nauk CCCP 12: 272-274. [Russian, English AUIC:8, NAMRU3:T95]
- Nikolskaya, M. N., 1952. The chalcid fauna of the USSR. — Izdatelstvo Akademii Nauk CCCP, Moskva-Leningrad: 1-575 (53-55, 60, 324, 338-390). [Russian, English]
- Noyes, J. S., 1977. New chalcids recorded from Great Britain and notes on some Walker species (Hym.: Encyrtidae, Eulophidae). — Entomologists Monthly Magazine 113(1352-1355): 9-13. [English]
- Noyes, J. S., and M. Hayat, 1984. A review of the genera of Indo-Pacific Encyrtidae (Hymenoptera: Chalcidoidea) — Bulletin of the British Museum of Natural History (Entomology) 48(3): 131-395 (288). [English]
- Oliver, J. H., 1964. A wasp parasite of the possum tick *Ixodes tasmani* in Australia. — The Pan-Pacific Entomologist 40(4): 227-230. [English]
- Parker, J. R., and W. J. Butler, 1929. Tick parasite liberation in Montana during 1928. — Biennial Report, Montana State Board of Entomology 7: 35-38. [English]
- Peck, O., 1951. Chalcidoidea. — In: Hymenoptera of America north of Mexico. Synoptic Catalogue. Eds. C. F. W. Muesebeck, K. V. Krombein and H. K. Townes. Agricultural Monograph, United States Department of Agriculture 2: 410-594 (503-504). [English]
- Peck, O., 1963. A catalogue of the Nearctic Chalcidoidea (Insecta: Hymenoptera). — Canadian Entomologist, Supplement 30: 458-461. [English]
- Peck, O., Z. Boucek, and A. Hoffer, 1964. Keys to the Chalcidoidea of Czechoslovakia (Insecta: Hymenoptera). — Memoirs of the Entomological Society of Canada 34: 1-120 (63,94). [English]
- Pervomaiskiy, G. S., 1940. Some data on ixodid tick control in foci of tick borne encephalitis. — In: Second conference on parasitological problems. Leningrad, November 1940. Ed. E. N. Pavlovsky. Izdatelstvo Akademii Nauk CCCP: 28-29. [Russian]
- Pervomaiskiy, G. S., 1943. On the natural infection of ticks, vectors of tick encephalitis, by hymenopteran parasites. — Zoologicheskii Zhurnal 22(4): 211-213. [Russian, English AUIC:5, NAMRU3:T1678]
- Pervomaiskiy, G. S., 1947. Control of ticks as a prophylactic measure against tick encephalitis and tick exanthemic fever. — Chapter 9. In: Parasites of the Far East, Ed. E. N. Pavlovsky: 286-300 (294). [Russian, English AUIC:6, NAMRU3:T1679]
- Pervomaiskiy, G. S., 1947. On the distribution of Ixodid tick parasites in a focus of tick-born encephalitis. — Priroda 36(11): 75-78. [Russian, English NAMRU3:T70]
- Philip, C. B., 1931. Découverte en Afrique Occidentale d'*Hunterellus bookeri* Howard, parasite des Ixodes. — Annales de Parasitologie Humaine et Comparative 9(3): 276. [French]
- Philip, C. B., 1931. Occurrence of a colony of the tick parasite *Hunterellus bookeri* Howard in West Africa. — Public Health Report, United States Public Health Service 46(37): 2168-2172. [English]
- Philip, C. B., 1954. A new locality record in Africa for the tick parasite, *Hunterellus bookeri* Howard. — Journal of Parasitology 40(2): 234-235. [English]
- Pomerancev, B. I., 1950. Ixodid ticks (Ixodidae). — Fauna CCCP, Izdatelstvo Akademii Nauk CCCP, Moskva. 4(2): 1-224 (48). [Russian]
- Prinsloo, G. L., and D. P. Annecke, 1972. A key to the genera of Encyrtidae from the Ethiopian region, with descriptions of three new genera (Hymenoptera: Chalcidoidea). — Journal of the Entomological Society of southern Africa 42(2): 349-382 (371). [English]



- Quarashi, M. S., 1958. Morphology of two Chalcidoid parasites of ticks, *Hunterellus bookeri* Howard, 1908 and *Ixodiphagus texanus* Howard, 1907. — American Midland Naturalist 59(2): 489-504. [English]
- Rao, S. R. M., 1943. Preliminary observations on the bionomics of *Hunterellus bookeri* How. (Hymenoptera), an insect parasite of tick together with a note on its distributions. — Proceedings of the 30th Indian Scientific Congress (Lucknow) Part III, Section 8: 87-88. (English)
- Rao, S. R. M., 1947. On the validity of *Ixodiphagus mysorensis* Mani, a chalcidoid parasite of ticks. — Proceedings of the 33rd Indian Scientific Congress (Bangalore) Part III, Section 9: 155. [English]
- Rao, S. R. M., 1949. Observations on the bionomics of *Hunterellus bookeri* How. (Hymenoptera), an insect parasite of tick together with a note on its distribution. — Bombay Veterinary College Magazine 1(1): 11-15. [English]
- Rechav, Y., 1978. Absence of Encyrtid parasites in adult *Amblyomma hebraeum* ticks (Acarina: Ixodidae). — Journal of Medical Entomology 14(6): 704. [English]
- Risbec, J., 1944. Un parasite des tiques du chien. — Notes Africaines 22: 3-4. [French]
- Risbec, J., 1951. Les Chalcidoïdes d'A. O. F. — Mémoires de l'Institut français d'Afrique Noire 13(1): 1-409 (170-172). [French]
- \* Risbec, J., 1954. Chalcidoïdes et Proctotrupides de l'Afrique Tropicale Française. — Bulletin de l'Institut français d'Afrique Noire 16: 1035-1092 (1070-1071). [French]
- Rubzov, I. A., 1967. Natural enemies and biological methods to combat insects of medical importance. — Izdatelstvo "Medizina": 1-120 (106-112). [Russian]
- Santos-Dias, J. A. T., 1969. Sera o *Hunterellus bookeri* Howard 1907 Hymenoptera-Chalcidoidea um eficaz elemento de controle natural das populacoes de *Amblyomma tholloni* Neumann 1899 em Mocambique? — Revista de Ciencias Veterinarias 2(A): 185-200. [Portuguese, English AUC:3, NAM-RU3:T1670]
- Shiple, A. E., 1914. Insects and war, IX Ticks. — British Medical Journal 2811: 830-832. [English]
- Smith, C. N., 1945. Biology of *Ixodes dentatus* Neuman (Ixodidae). — Annals of the Entomological Society of America 38: 223-233. [English]
- Smith, C. N., and M. M. Cole, 1943. Studies of parasites of the American dog tick. — Journal of Economic Entomology 36(5): 569-572. [English]
- Smith, C. N., M. M. Cole and H. K. Gouck, 1946. Biology and control of the American dog tick. — Technical Bulletin, United States Department of Agriculture 905: 1-74 (72). [English]
- Soni, B. N., and S. C. Srivastava, 1967. Observations on the bionomics of *Hunterellus bookeri*, the parasite of ticks in India. — Proceedings of the 44th Indian Scientific Congress (Calcutta) Part III, Section 9: 380. [English]
- Steyn, J. J., 1955. A second locality record in Uganda for the tick parasite "*Hunterellus bookeri*" Howard and a few discussions on other tick parasites. — East African Medical Journal 32: 357-360. [English]
- \* Strong, L. A., 1937. Report of the Chief of the Bureau of Entomology and Plant Quarantine, 1936. — Report, United States Department of Agriculture Washington D.C. [English]
- Subba Rao, B. R., and M. Hayat, 1985. The Chalcidoidea (Insecta: Hymenoptera) of India and adjacent countries. Part 1, Reviews of families and genera. — Oriental Insects 19: 163-310 (195, 203, 205). [English]
- Tate, H. D., 1941. The biology of the tropical cattle tick and other species of tick in Puerto Rico, with notes on the effects on ticks of arsenical dips. — Journal of Agriculture of the University of Puerto Rico 25(1): 1-24 (20-21, 24). [English]
- Thompson, W. R., 1954. A catalogue of the parasites and predators of insect pests. — Section 2, Host parasite catalogue, Part 3, Hosts of the Hymenoptera (Calliceratid to Euanid). — Commonwealth Institute of Biological Control, CAB: 1-332 (255-256). [English]
- Timberlake, P. H., 1922. *Hunterellus bookeri* Howard in India. — Proceedings of the Hawaii Entomology Society 15(1): 10.

- Trjapitzin, V. A., 1982. A redescription of *Ixodiphagus hirtus* Nikolskaya, 1950 (Hymenoptera, Encyrtidae), a parasite of the taiga tick *Ixodes persulcatus* of the Far East of the USSR. — *Parazitologia* 16(6): 489-493. [Russian, English AUIIC:12]
- Trjapitzin, V. A., 1985. Natural enemies of the Taiga tick. — Chapter 6. In: *The Taiga tick Ixodes persulcatus* (Acarina, Ixodidae). Morphology, Systematics, Ecology, Medical importance. Ed. N. A. Filippova, Nauky Leningrad, Leningrad: 1-416 (334-341). [Russian]
- Trjapitzin, V. A., and G. Gordh, 1978. Review of genera of Nearctic Encyrtidae (Hymenoptera, Chalcidoidea, Encyrtidae). I. — *Entomologicheskoe Obozrenie, Akademiya Nauk CCCP* 57(2): 364-385 (372, 379). [Russian]
- Ushakova, G. V., 1962. On the findings of *Hunterellus hookeri* How., parasites of ixodid ticks in Kazakhstan. — *Trudy Kazakhstanoj Instituta Zoologicheskova Akademiya Nauk CCP* 16: 183-185. [Russian, English NAMRU3:T98]
- Wolcott, G. N., 1923. "Insectae Portoricensis". A preliminary annotated checklist of the insects of Porto Rico, with descriptions of some new species. — *Journal of the Department of Agriculture of Porto Rico* 7(1): 5-313 (60). [English]
- Wood, H. P., 1911. Notes on the life history of the tick parasite *Hunterellus hookeri* Howard. — *Journal of Economic Entomology* 4: 425-431. [English]
- Zasukhin, D. M., 1934. A biological method of control for *Dermacentor* ticks. — *Vestnik Mikrobiologii* 13(2): 169-171. [Russian, English NAMRU3:T1643]

---

Author's present adress: 101, Rue St. Dominique, 75007 Paris, France.













QL  
461  
T568  
Ent.

# TIJDSCHRIFT VOOR ENTOMOLOGIE

UITGEGEVEN DOOR

DE NEDERLANDSE ENTOMOLOGISCHE VERENIGING

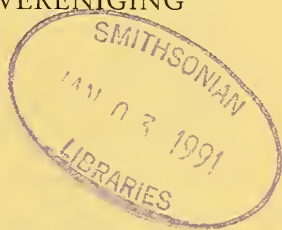

## INHOUD

H. R. BOLLAND. — Review of the systematics of the family Camerobiidae (Acari, Raphignathoidea). I. The genera *Camerobia*, *Decaphyllobius*, *Tillandsobius*, and *Tycherobius*, pp. 191—215, figs. 1—66.



# REVIEW OF THE SYSTEMATICS OF THE FAMILY CAMEROBIIDAE (ACARI, RAPHIGNATHOIDEA). I. THE GENERA CAMEROBIA, DECAPHYLLOBIUS, TILLANDSOBIUS, AND TYCHEROBIUS

by

H. R. BOLLAND

Laboratory of Experimental Entomology, University of Amsterdam, The Netherlands

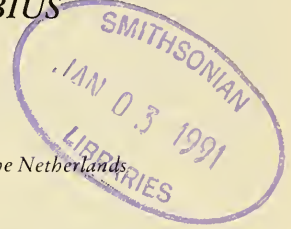

## ABSTRACT

A review and a new classification of the family Camerobiidae are given. The family is now divided into five genera. A general key to the genera and a key to the species of the genera *Camerobia*, *Decaphyllobius*, *Tillandsobius* and *Tycherobius* are given. The species of the genus *Neophyllobius* will be described in the near future. The genus *Camerobia* now contains four species: the two new species, *C. pistaciae* and *C. monspeliensis*, and the earlier described species *C. australis* and *C. southcotti*. The latter one is the only known species in the family with dorso-sublateral setae. Three new genera are described: *Decaphyllobius* (type-species: *D. gersoni* spec. nov.), *Tillandsobius* (type-species: *Neophyllobius floridensis* McGregor) and *Tycherobius* (type-species: *Neophyllobius lombardinii* Summers & Schlinger). *Neophyllobius superbus* and *N. virginiensis* are transferred to *Tycherobius* gen. nov. which also contains the new species *T. polonicus* and *T. stramenticola*. *Neophyllobius citri*, *N. agrifoliae* and *N. hadros* are tentatively assigned to the genus *Decaphyllobius* gen. nov. and *Neophyllobius rhytis* to the genus *Tycherobius* gen. nov. but this requires confirmation by study of the type-series.

## INTRODUCTION

The stilt-legged mites (family Camerobiidae Southcott) form a group of Acari with a distinct and characteristic habitus. They have a dorso-ventrally flattened body provided with eight slender long legs on which they move rather cautiously.

Stilt-legged mites are usually found singly, or in very small numbers. For this reason many descriptions are based on single specimens. Aggregation of adult mites has never been reported; only juveniles seem to remain close to each other. It is therefore conceivable that even on favoured plants stilt-legged mites occur in low numbers. They are also found in grass, straw and tree litter of leaf mold samples, while their presence in soil samples is rather exceptional.

Very little is known about the biology of these mites. Only recently, the complete developmental cycle of a *Neophyllobius* sp. was described. It consists of egg, larva, protonymph and deutonymph. The deutonymph is very similar to the adult and has not been recognized as that before (Bolland, 1983).

Presumably all camerobiid mites are predators, preying on plant-associated mites, such as

gall, false spider and tydeid mites (Bolland, 1983; De Leon, 1958). They are also reported as predators of crawlers of scale insects (Meyer, 1962; Richards, 1962; Gerson, 1971, 1973; Gerson et al., in prep.; Hassan, 1976; Zaher & Gouma, 1979). Camerobiid mites are probably of little importance in regulating numbers of phytophagous mites or scale insects in plant ecosystems.

There are no reports on the dispersal of stilt-legged mites and information on their reproductive rates are likewise absent. Bisexuality has been demonstrated for a number of species. Karyotype studies have shown that sex-determination is based on haplo-diploidy: chromosome numbers of  $2n = 22$  and  $n = 11$  have been found in the eggs of *Neophyllobius aesculi* Bolland (Bolland, 1983). Haplo-diploidy is common in the order of Prostigmata (Helle et al., 1984).

It should be noted that a number of  $n = 11$  is relatively high, since in other prostigmatic taxa the haploid numbers are usually lower, with  $n = 2$  and  $n = 3$  as being the most common.

Camerobiidae are capable of spinning: females of *N. aesculi* produce fine webbings to



cover their eggs (Bolland, 1983). The location of the spinneret is not known, but silken threads may very well be secreted through the eupathidia on the palptarsi. Several members of other prostigmatid families also produce silk, including the Bdellidae, Cunaxidae, Cheyletidae and Tetranychidae (Alberti & Ehrnsberger, 1977; Gerson, 1985).

Until now, only two genera were recognized in the Camerobiidae: *Camerobia* with two species (Southcott, 1957; Gerson, 1972) and *Neophyllobius* with 44 species.

The distribution of the Camerobiidae is worldwide. They have been reported from Europe, Asia, Africa, North and South America, Australia and New-Zealand, and from temperate as well as tropical zones. During the last few years the author studied many camerobiid specimens, belonging to 98 species, of which 50 appeared to be new. After this comprehensive study it was felt that the erection of more genera than *Camerobia* and *Neophyllobius* is justified. Therefore three new genera, namely *Decaphyllobius*, *Tillandsobius* and *Tycherobius* are proposed and separated by a key from the two genera recognized so far.

This paper further comprises a general review of the external morphology of the different developmental stages, the history of the family and the description of three new species, one in the genus *Decaphyllobius* gen. nov. and two in the genus *Tycherobius* gen. nov. The genus *Neophyllobius* will be dealt with elsewhere.

The chaetotaxy of the different genera of the Raphignathoidea (Atyeo, 1963), is difficult to compare with that of the Camerobiidae.

The terminology employed here is similar to that used by Gerson (1968). All measurements are given in  $\mu\text{m}$  and refer to the holotype, those in parentheses pertain to the paratypes. Scanning electronic microscopic (SEM) micrographs are given of a protonymph of *Decaphyllobius gersoni* spec. nov. (figs. 31—36).

#### ACKNOWLEDGEMENTS AND DEPOSITORIES OF MATERIAL STUDIED

The material studied in this paper belongs to the collections of the institutions mentioned below. I am indebted to the keepers of these collections for the loan of specimens. The abbreviations of the institutions are used throughout the text.

- BM(NH) British Museum (Natural History), Cromwell Road, London; Mr D. Macfarlane
- CAU College of Agricultural University, Szarvas, Hungary; Dr P. Szabo
- CS Collection Southcott, Mitcham, South-Australia; Dr R. V. Southcott
- DEUAL Department of Entomology, University of Agriculture, Lyallpur, Pakistan; Dr W. M. Chaudhri
- DCDG Doyle Conner, Commissioner of Agriculture, Division of Plant Industry, Gainesville, Florida; Dr H. A. Denmark
- FAUC Faculty of Agriculture, University of Cairo, Giza, Egypt; Dr M. A. Zaher
- HUJ Hebrew University of Jerusalem, Faculty of Agriculture, Rehovot, Israel; Dr U. Gerson
- ISZA Istituto Sperimentale par la Zoologia Agraria, Firenze, Italia; Dr F. Pegazzano
- SAM South Australian Museum, Adelaide, Australia; Mr D. C. Lee
- UAM Uniwersytet im A Mickiewica, Instytut Biologii, Poznan, Poland; Dr M. Kalizewski
- UMC University of Missouri Columbia, Missouri, U.S.A.; Dr W. R. Enns
- USNM National Museum of Natural History, (formerly United States National Museum), Smithsonian Institution, Washington, D.C., Dr E. W. Baker.
- ZMA Instituut voor Taxonomische Zoologie (Zoological Museum), University of Amsterdam, The Netherlands; Dr J. P. Duffels

I am grateful to Prof Dr W. Helle for his help and comments during the preparation of this manuscript. Thanks are due to Dr M. K. P. Smith-Meyer and to Prof Dr U. Gerson for helpful suggestions, critical remarks and the latter also for placing the scanning electron microscopic micrographs of *Decaphyllobius gersoni* spec. nov. at my disposal.

#### CAMEROBIIDAE Southcott, 1957

Type species: *Camerobia australis* Southcott, 1957.

#### Description.

Body small, 210—400  $\mu\text{m}$ , broadly oval or rounded, dorso-ventrally flattened, greatest

width in front of coxae III, without a sejugal furrow. Mites coloured with haemolymph pigments, probably carotenoids, giving a yellowish, greenish, brownish or reddish appearance. Midgut often visible from above as a white medial tape in opisthosoma. Body weakly sclerotized and cuticle wrinkled. On dorsum, areas with fine striation patterns can be recognized, often separated from each other by longitudinal or transverse bands, of coarse striae.

Two double-lensed eyes are always present lateral to the line between the third and fourth dorso-lateral setae (= *l*). There are nine to ten pairs of *l* setae and five to six pairs of dorso-central setae (= *mc*). The shape of the dorsal setae ranges from short palmate to very long whip-like. Dorsal setae placed on small or large tubercles. Setae *l*<sub>5</sub> always located anterior to coxae III. One short, supra-coxal seta situated lateral to *l*<sub>2</sub>.

There are three pairs of ventral setae. In addition, there are two pairs of genital and three pairs of anal setae. Ventrally, close to the palp basis, is a pair of hardly discernible coxal setae. The legs are often stilt-like, because of an elongation of the femora and tibiae. The genua are relatively short. The coxae are arranged into two groups, with a space between coxae II and III.

Coxae I—IV with a setal formula of 3-1-2-2 setae. Trochanters with no or one seta. Femora with one to six setae, depending on the species. Genua with one or two setae; genua I and II each with a solenidion distal to the setae (fig. 33).

Tibiae with different numbers of setae, ranging from six to nine. Numbers and location of tibial setae are of generic significance. Very often, a distally located solenidion is present. Tarsi with different numbers of setae, ranging from six to ten. Two of the distal setae are always bifid. One, exceptionally two solenidia are present on tarsi I and II. The empodium, between the two claws, is pad-like, provided with two rows of capitate tenent hairs.

The small gnathosoma is almost covered by the anterior flap of the prodorsum. Basal parts of the chelicerae fused; stylets short, dagger-like and movable. Tortuous peritremata arise on the dorsum of the gnathosoma and consist of one, two or four almost complete loops; pedipalps divided into five segments with the following setation: trochanter without seta, femur has two

setae, genu one seta and tibia two to four setae. One of the tibial setae is sword-like and is probably a vestigial palptibial claw. Tarsus with one or two setae. In addition, palptarsus with one solenidion and one or two eupathidia.

#### Developmental stages.

Larva hexapod. *Mc*<sub>1</sub> lacking. Only two pairs of ventral and three pairs of anal setae. Coxa I with one seta, II and III without setae.

Protonymph octopod. Setae on coxa IV and trochanter IV lacking.

Deutonymph in size and setation roughly similar to adult. The genual setae often longer than in the adult. Many authors, not aware of the existence of two separate nymphal stages, use the word "nymph" instead of protonymph.

#### History.

The genus *Neophyllobius* was classified in the family Tetranychidae by Berlese (1886), Canestrini (1890), Geijskes (1939) and Womersley (1940). On the contrary McGregor (1950) placed it in the Stigmaeidae; Baker & Wharton (1952) in the Raphignathidae; Summers & Schlinger (1955), Meyer & Ryke (1959), Atyeo (1961), Meyer (1962), Wood (1964) and Chaudhri (1974) in the Calligonellidae.

Southcott (1957) erected two separate families, viz., Neophyllobiidae and Camerobiidae. This practice was followed by De Leon (1958, 1959, 1967), Soliman & Zaher (1967), Summers (1966), Gerson (1968), Smiley & Moser (1968), Krantz (1970), Livshits & Mitrofanov (1975, 1980) and Zaher & Gomaa (1979). Gerson (1972) pointed out that two of the characters used to separate these two families i.e. the palmate dorsal body setae and the absence of ultra-long setae on the genua, are inconsistent and that the third one, the presence of a camerosome, is invalid. Therefore he synonymized Neophyllobiidae with Camerobiidae and placed *Neophyllobius* in the latter family. This concept had been followed by Robaux (1975), Kuznetsov & Livshits (1979), Kethley (1982), Krantz (1978) and Bolland (1983).

#### Diagnosis.

The Camerobiidae are separated from other raphignathoid families by their long legs having elongate femora and tibiae, by the location of the peritremata, by the fused chelicerae, by the location of the anal area, by the position of the coxal fields and by the absence of a sejugal fur-

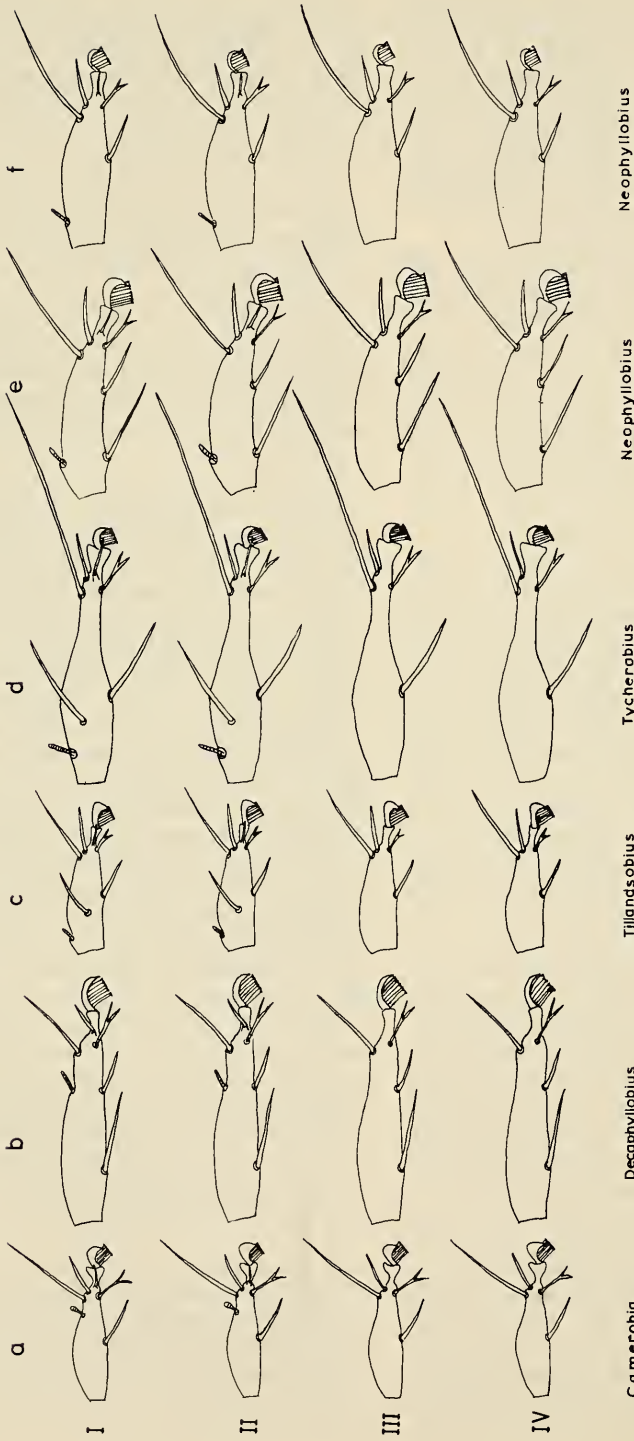

Fig. 1 a—f. Schematic variation in setal pattern of tarsi I—IV and the position of the solenidia on tarsi, in the genera *Cameroibia*, *Decaphyllobius*, *Tillandsobius*, *Tycherobius* and *Neophyllobius* of the family Camerobiidae.



row. A whip-like seta is often present on the short genua. The palptibia bears a "long sword-like" seta instead of a short "thumbclaw".

KEY TO THE GENERA OF CAMEROBIIDAE  
(based on females)

1. Solenidion on tarsi I and II situated distally (fig. 1a/b) ..... 2<sup>1)</sup>
- Solenidion on tarsi I and II situated proximally (fig. 1c—f) ..... 3
2. Dorsum with nine *l* setae; tibial setal formula I—IV: 7 (6)—6-6-6; trochanter I without setae (fig. 9) .... *Camerobia* Southcott
- Dorsum with ten *l* setae; tibial setal formula I—IV: 8-7-7-7; trochanter I with one seta (fig. 25) ..... *Decaphyllobius* gen. nov.
3. Tibial setal formula I—IV: 8-7-6-6 (fig. 40); two medio-ventral setae on tarsi I and II not placed in a longitudinal line (fig. 1c) .... *Tillandsobius* gen. nov.
- Tibial setal formula I—IV: 9-8-7-7 (fig. 49); two medio-ventral setae on tarsi I and II not placed in a longitudinal line (fig. 1d) .... *Tycherobius* gen. nov.
- Tibial setal formula I—IV: 9-8-8-7; one or two medio-ventral seta(e) on tarsi I and II. If two setae present, the setae placed in a longitudinal line (fig. 1e) ..... *Neophyllobius* Berlese

***Camerobia* Southcott, 1957**

*Camerobia* Southcott, 1957: 306—312.

Type species: *Camerobia australis* Southcott, 1957.

Dorsum with 15—17 pairs of short and round to budlike setae, with a short stalk and placed on small tubercles. The *mc*<sub>1</sub> setae are placed on the same transversal level as the *l*<sub>3</sub> setae. Dorsum with a rough striation pattern laterally and finer transversal striae mediad. Peritremata consist of four almost complete loops. Trochanter I without setae. Genua setae short. Tibiae with six or seven setae of two types. Each tibia also has a long solenidion on the distal end.

All tarsi with only one mid-ventral seta. Tarsi I and II have seven and tarsi III and IV six distal setae of which two are always bifurcated. Tarsi I and II have a solenidion at their distal half.

Palptibiae with one seta and a sword-like seta, palptarsi with one seta, one eupathidium and a solenidion.

<sup>1)</sup> See discussion under *Neophyllobius hadros*.

Key to the species of *Camerobia*

1. Femur I with six setae (fig. 9) ..... 2
- Femur I with five setae (fig. 4) . *C. australis*
2. Femur III with four setae; tibia I with seven setae (fig. 19) ..... 3
- Femur III with three setae; tibia I with six setae (fig. 9) ..... *C. pistaciae* spec. nov.
3. Dorsum without sub-lateral setae; bush-like ..... *C. southcotti*
- Dorsum with two pairs of sub-lateral setae; bud-like ..... *C. monspeliensis* spec. nov.

***Camerobia australis* Southcott**

(figs. 2—6)

*Camerobia australis* Southcott, 1957: 306—312.

Female: Body length 295 (250)µm, width 275 (220)µm. Length of legs: (295; 265; 270; 320 µm). Six pairs of *mc* and nine pairs of *l*; 18—25 (all 15) µm long and 12—20 (5) µm wide. Inter-setal distances: *l*<sub>1</sub>-*l*<sub>2</sub>; *l*<sub>2</sub>-*l*<sub>3</sub>; *l*<sub>3</sub>-*l*<sub>4</sub> = (25; 45; 30 µm). Leg setation: coxae 3-1-2-2, trochanters 0-1-1-1, femora 5-4-2-2, genua 1-1-1-1, tibiae 6-6-6-6, tarsi 8-8-7-7. Pedipalp setation: trochanter 0, femur 2, genu 1, tibia 1 + 1 sword-like seta, tarsus 1 + 1 eupathidium.

The dorsal setae are much smaller than those of *C. southcotti* Gerson, and their width is about one third of their length. There is only one seta on the distal end of each femur; *C. southcotti* has two setae on each femur in a transverse row on the distal end.

Male: Unknown.

Material examined: Paratype ♀, Australia, Queensland, Kaban, Atherton Tableland, under bark of *Eucalyptus* sp., 24.viii.1944, R. V. Southcott (CS no. ACC 330).

Other published material: Holotype ♀, Australia, Tableland, Kaban, Atherton, under bark of *Eucalyptus* sp., 24.viii.1944, R. V. Southcott (CS no. ACC 329). Paratypes: 1 ♀, South Australia, Glen Osmond, under bark of *Eucalyptus camaldulensis*, 17.iii.1937, R. V. Southcott (CS no. ACC 331); 1 ♀, Australia, Grovely near Brisbane, probably from *Eucalyptus* sp., 25.viii.1945, R. V. Southcott (CS no. ACC 332).

***Camerobia pistaciae* spec. nov.**

(figs. 7—12)

*Camerobia australis* Southcott; Szabó, 1980: 376. Misidentification.

Female: Body length 280 µm, width 240 µm. Length of legs: 280; 265; 275; 280 µm. Six pairs of *mc*: 30; 30; 30; 30; 30; 25 µm. Nine pairs of *l*:

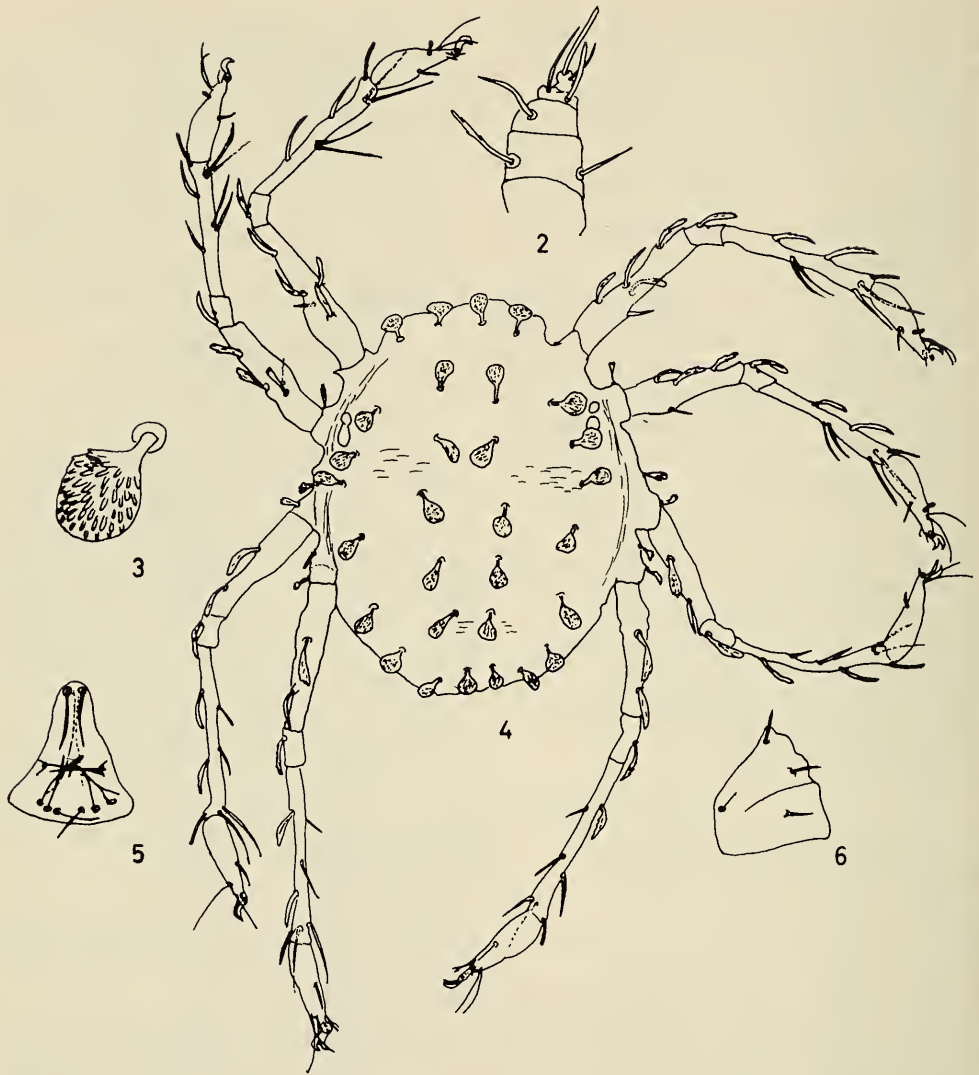

Figs. 2—6. *Camerobia australis* Southcott, ♀. 2, pedipalp; 3, dorsal seta; 4, dorsal view; 5, genital-anal region; 6 coxae I and II.

25; 25; 25; 30; 30; 30; 25; 25  $\mu\text{m}$ . All dorsal setae are 25—30  $\mu\text{m}$  wide. Inter-setal distances:  $l_1-l_2$ ;  $l_2-l_3$ ;  $l_3-l_4$  = 30, 30, 30  $\mu\text{m}$ . Leg setation: coxae 3-1-2-2, trochanters 0-1-1-1, femora 6-5-3-3, genua 1-1-1-1, tibiae 6-6-6-6, tarsi 8-8-7-7. Pedipalp setation; trochanter 0, femur 2, genu 1, tibia 1 + 1 sword-like seta, tarsus 1 + 1 eupa-

thidium. The genual setae are short. The dorsal setae are more or less palmate, spiculate and basically with a small stalk.

Each femur has two setae on a transversal level at the distal end.

Male: Unknown.

Protonymph: Six pairs of *mc*. Nine pairs of *l*.

Figs. 7—12. *Camerobia pistaciae* spec. nov., ♀. 7, pedipalp; 8, coxae I and II; 9, dorsal view; 10, dorsal seta; 11, genital-anal region; protonymph. 12, dorsal view.







Figs. 13—16. *Camerobia southcottii* Gerson, ♀. 13, pedipalp; 14, dorsal seta; 15, coxae I and II; 16, dorsal view.

Leg setation: coxae 3-1-2-0, trochanters 0-1-1-0, femora 3-2-1-1, genua 1-1-1-1, tibiae 5-5-5-3, tarsi 1-1-1-1 (mid-ventral), distal parts of tarsi indistinct.

Type material: Holotype ♀, Israel, Zikhron Yaakov, on *Pistacia* branches, 23.xiii.1981, U. Gerson (ZMA). Paratypes: 2 protonymphs same data as holotype; 1 ♀, Hungary, Szarvas, on *Corylus avellana*, 14.x.1979, P. Szabó (CAU).

Remarks. The Hungarian specimen was studied from photographs taken by Dr P. Szabó. This specimen does not belong to *C. australis* but is conspecific with the holotype of *C. pistaciae*. This species differs from *C. australis* by having six setae on femur I instead of five. The dorsal setae are longer and wider (25/30 µm) than those of *C. southcottii* and are more spicu-

late. In contrast to *C. southcottii*, *C. pistaciae* has femur III with three setae and tibia I with six setae.

***Camerobia southcottii* Gerson**  
(figs. 13—16)

*Camerobia southcottii* Gerson, 1972: 502—508.

Female: Body length 265 (262) µm, width 235 (227; 231) µm. Length of legs: 280; 250; 255; 270 µm. Six pairs of *mc*: 20; 20; 20; 20; 20; 20. Nine pairs of *l*: 25; 25; 20; 20; 20; 20; 20; 20; 20 µm. All dorsal setae are 15 µm wide. Inter-setal distances:  $l_1-l_2$ ;  $l_2-l_3$ ;  $l_3-l_4$  = 20, 30, 25 µm.

Leg setation: coxae 3-1-2-2, trochanters 0-1-1-1, femora 6-5-4-3, genua 1-1-1-1, tibiae 7-6-6-6, tarsi 8-8-7-7. Pedipalp setation: trochanter 0, femur 2, genu 1, tibia 1 + 1 sword-like setae, tarsus 1 + 1 eupathidium. The genual setae are short. The dorsal setae are bushlike, spiculate,

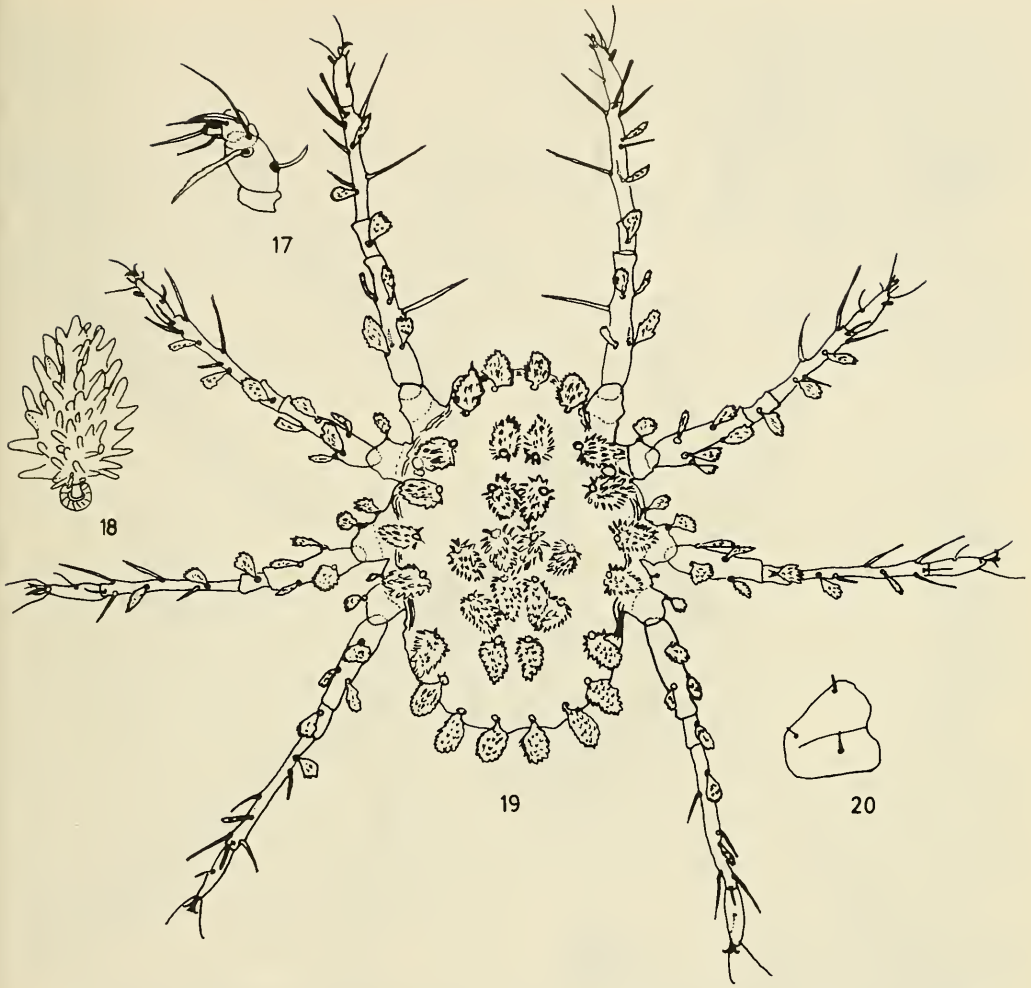

Figs. 17—20. *Camerobia monspeliensis* spec. nov., ♀. 17, pedipalp; 18, dorsal seta; 19, dorsal view; 20, coxae I and II.

and basally with a small stalk. Each femur has two setae in a transverse row at the distal end.

Male: Unknown.

Material examined: Holotype ♀, Israel, Montfort, on *Pistacia* tree, 31.iii.1970, U. Gerson (HUJ no. 2300).

Other published material: Paratypes: 1 ♀ (USNM); 1 ♀ (SAM no. ACC 866), both same collection data as holotype.

Remarks. According to Gerson (1972) this species has four setae on femur III and seven setae on tibia I, which are different in *C. pistaciae* spec. nov.

The dorsal setae are shorter and smaller ((11—12); (13—14); (15—17))  $\mu\text{m}$  than those of *C. pistaciae* spec. nov. and are less spiculate.

This species differs from *C. australis* in having six setae on femur I instead of five and seven setae on tibia I instead of six. The dorsal setae are more rounded and larger. Also the location of the femoral setae is different in both species.

*Camerobia monspeliensis* spec. nov.  
(figs. 17—20)

Female: Body length 250  $\mu\text{m}$ , width 193  $\mu\text{m}$ . Length of legs: 271; 240; 259; 271  $\mu\text{m}$ . Six pairs of *mc*: all 31  $\mu\text{m}$ . Nine pairs of *l*: 28; 28; 31; 31; 31; 31; 31; 31; 31  $\mu\text{m}$ .



Figs. 21—26. *Decaphyllobius gersoni* spec. nov., ♀. 21, peritremata and stylets; 22, pedipalp; 23, dorsal seta; 24, coxae I and II; 25, dorsal view; 26 caudal-dorsal seta.

Two pairs of sub-lateral setae (= *sl*): 31; 31  $\mu\text{m}$ . All dorsal setae are, at widest point, 16  $\mu\text{m}$  wide. Inter-setal distances:  $l_1-l_2$ ;  $l_2-l_3$ ;  $l_3-l_4$  = 30, 30, 20  $\mu\text{m}$ . Leg setation: coxae 3-1-2-2, trochanters 0-1-1-1, femora 6-5-4-3, genera 1-1-1-

1, tibiae 7-6-6-6, tarsi 8-8-7-7. Pedipalp setation: trochanter 0, femur 2, genu 1, tibia 1 + 1 sword-like seta, tarsus 1 + 1 eupathidium. The genual setae are short. The dorsal setae are more budlike, spiculate and with a small stalk. Each



femur has two setae in a transverse row on the distal part.

Male: Unknown.

Type material: Holotype ♀, France, Montpellier, on *Platanus acerifolia* Willd., 28.xi.1985, H. R. Bolland (ZMA).

Remarks. This species can be differentiated from the three other *Camerobia* species, by having two pairs of sub-lateral setae (= *sl*) on the opisthosoma. It is the only species in the family Camerobiidae which possesses these *sl* setae. *Camerobia monspeliensis* has seven setae on tibia I and four setae on femur III, resembling *C. southcottii*.

#### *Decaphyllobius* gen. nov.

Type species: *Decaphyllobius gersoni* spec. nov.; by present designation.

Dorsum with 16 pairs of setae. There is an extra pair of  $l_1$  setae ( $l_{1A}$ ).  $L_2$  and  $l_3$  setae are closer together than  $l_1$  and  $l_2$ .  $Mc_1$  and  $mc_2$  are close to each other and posterior to level of  $l_3$ . Peritremata consist of two almost complete loops. Trochanters I—IV each with one seta. There are one or two (see *Neophyllobius agrifoliae* McGregor) short, genual setae. Tibia I with eight whereas other tibiae have seven setae. A solenidion at the distal end of the tibiae is not always present. Tarsi I and II each with a solenidion on distal half (see discussion under *Neophyllobius hadros* Chaudhri). Palptibiae with three setae and a sword-like seta, palptarsi with two setae, two eupathidia and a solenidion.

#### *Decaphyllobius gersoni* spec. nov.

(figs. 21—36)

Female: Body length 310 (300—305)  $\mu\text{m}$ , width 280 (255—285)  $\mu\text{m}$ . Length of legs: 495; 435; 490; 525 (500—545; 450—500; 500—550; 560—565)  $\mu\text{m}$ .

Six pairs of *mc*: 60; 60; 65; 60; 40; 30 (55; 60; 75; 70; 50; 30)  $\mu\text{m}$ . Ten pairs of *l*: 45; 45; 60; 50; 60; 70; 40; 45; 30; 35 (35—45; 35—45; 50—55; 45—50; 55; 60—65; 30—35; 35—40; 30—35; 25)  $\mu\text{m}$ . Inter-setal distances:  $l_1$ - $l_2$ ;  $l_2$ - $l_3$ ;  $l_3$ - $l_4$  = 35; 10; 40  $\mu\text{m}$ . Leg setation: coxae 3-1-2-2, trochanters 1-1-1-1, femora 4-4-3-2, genua 1-1-1-1, tibiae 8-7-7-7, tarsi 8-8-6-6. Pedipalp setation: trochanter 0, femur 2, genu 1, tibia 3 + 1 sword-like seta, tarsus 2 + 2 eupathidia. The solenidia on tarsus I and II are situated on the distal part of each tarsus. Tarsi I—IV all with two setae in a ventral position, see figure 1b.

Tibiae I—IV devoid of solenidia. There are two different types of setae on the dorsum: broadly lanceolate and spatulate ( $l_8$ ,  $l_9$  and  $mc_6$ ). All dorsal setae with a stalk, located on tubercles. From the outer margins a band of coarse striae is present posterior to  $l_7$  and curves anterior to  $mc_5$ , rest of posterior part of opisthosoma also covered by coarse striae.

Male: Body smaller,  $mc_6$  reduced in length.

There is only one solenidion on the distal end of tibia I, whereas most males of the Camerobiidae have two. All four tarsi have basically a male solenidion. There are no ventral genital setae but four pairs of anal setae.

Protonymph: Six pairs of *mc* setae and ten pairs of *l* setae. Leg setation: coxae 3-1-2-0, trochanters 1-1-1-0, femora 3-2-1-1, genua 1-1-1-1, tibiae 5-5-5-3, tarsi 1-1-1-1 (mid-ventral); setae at distal end of tarsus indistinct. One short solenidion at distal end of tibia I. The "lay-out" of the solenidia on tarsi III—IV, which are placed in a more proximal position, strongly indicating that it is a male-protonymph. The dorsal setae are of a different shape than in the adult. SEM micrographs of a protonymph are given in figures 31—36.

Larva: Five pairs of *mc* setae;  $mc_1$  absent. Nine pairs of *l* setae;  $l_2$  absent. Leg setation: coxae 2-0-0, trochanters 0-0-0, femora 2-2-1, genua 1-1-1, tibiae 3-3-3, tarsi 1-1-1 (mid-ventral). Distal parts of tarsi indistinct. The solenidia on distal ends of tibiae I—IV are missing.

*D. gersoni* was found on galls of *Obdulia* sp. (Acari: Tenuipalpidae) on tamarisk trees. This species is named after Dr U. Gerson (HUJ).

Type material: Holotype ♀, Israel, Elat, on *Tamarix aphylla*, 23.v.1975, U. Gerson (HUJ no. 2764). Paratypes: allotype ♂ (HUJ no. 2763); 2 ♀ (HUJ no. 2769 and 2770); 1 (♂) protonymph (HUJ no. 2766); 1 larva (HUJ no. 2765), all with the same collection data as holotype.

The following three species are tentatively assigned to *Decaphyllobius*. Confirmation requires study of the type series.

*Neophyllobius citri* Soliman & Zaher, 1967: 27, 28, (♂ and ♀). Type material: the holotype ♀ and allotype ♂ were collected in Upper Egypt, Kom Ombo, on citrus trees, and are no longer present in the FAUC.

*Neophyllobius agrifoliae* McGregor, 1950: 56—58; McDaniel, 1979: 201, 202, pl. 386. Type material: holotype ♀, U.S.A., California,

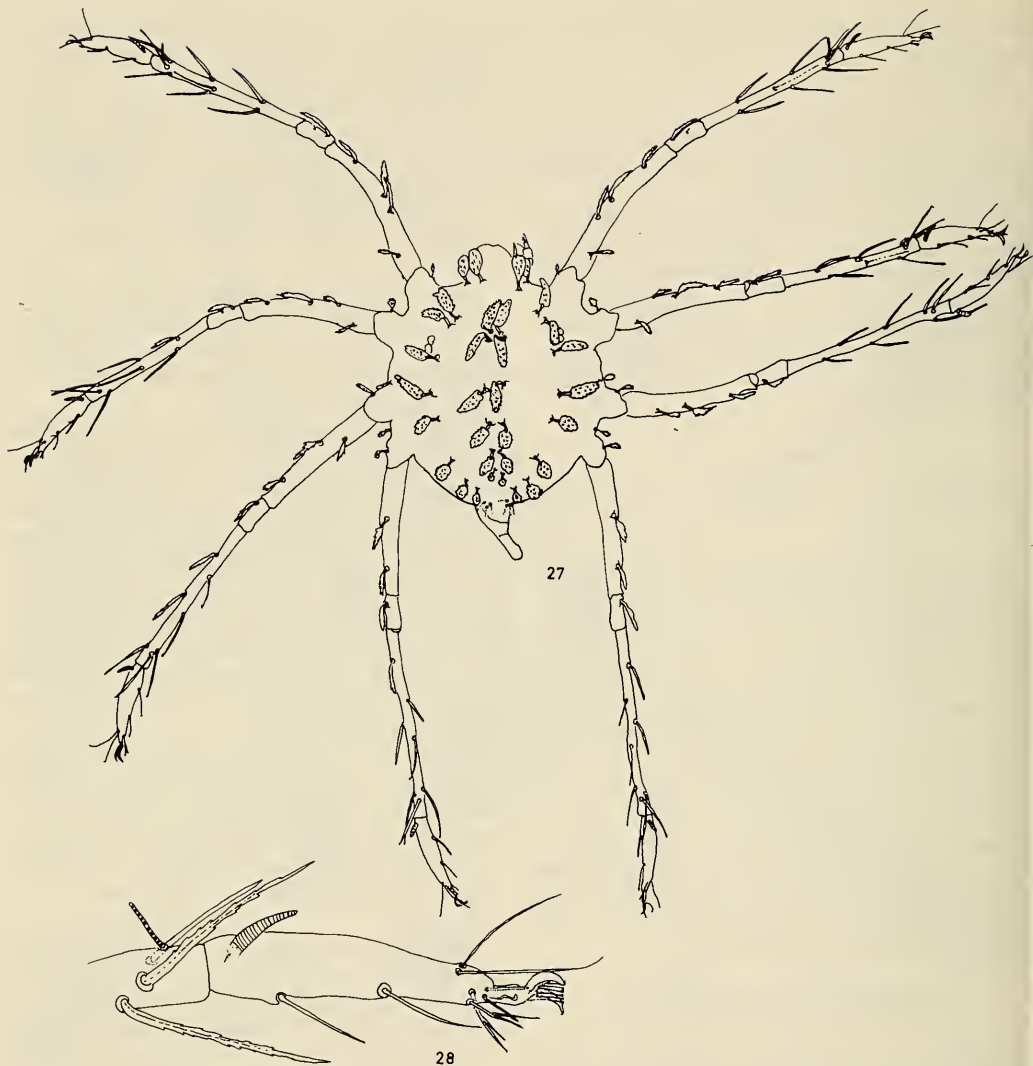

Figs. 27—28. *Decaphyllobius gersoni* spec. nov., ♂. 27, dorsal view; 28, tarsus I and distal part of tibia I.

South Pasadena, on *Quercus agrifolia*, 3.ix.1938, B. L. Boyden (USNM no. 1746, (1757?)). No specimen was present on the type slide. Plate 15 fig. 4 (McGregor, 1950) gives two setae on genua I—IV.

*Neophyllobius hadros* Chaudhri, 1974: 188—198. Type material: holotype ♀, Pakistan, Univ. Agric. Lyallpur, Campus, *Cyclops* spec., 4.iv.1971, W. M. Chaudhri (DEUAL). Paratype: 1 ♀, Pakistan, one mi. N. Vehari, *Salva-*

*dora oleoides*, 21.i.1972, W. M. Chaudhri (DEUAL).

Judging from the description by Chaudhri (1974), there are probably two solenidia on each of tarsi I and II. The distal one is important for genus recognition. According to the latter author the proximal solenidium is also present on tarsi I and II. It is noteworthy to mention that the presence of two solenidia on tarsi I and II is rare for the Camerobiidae.

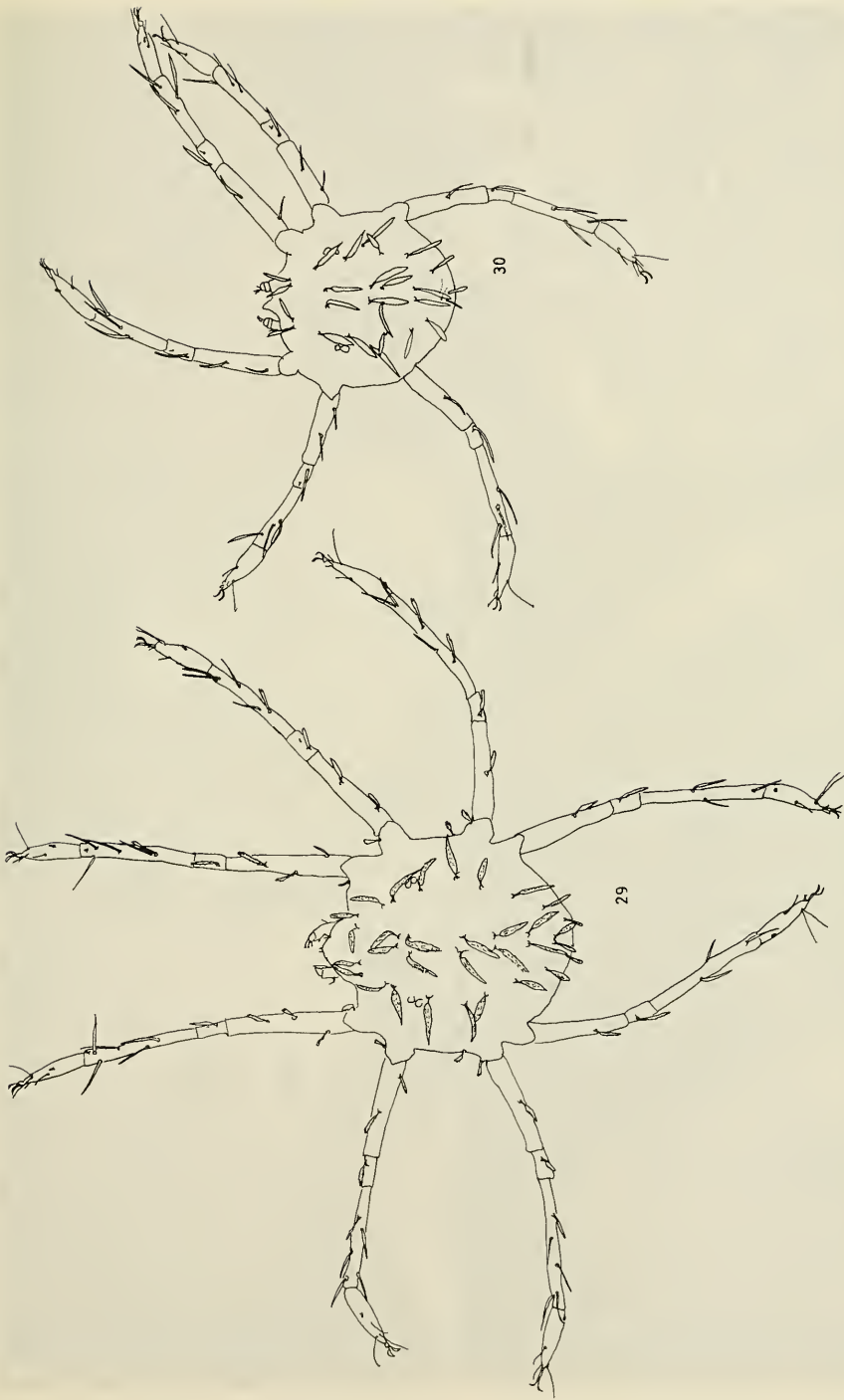

Figs. 29—30. *Decaphyllobius gersoni* spec. nov., protonymph. 29, dorsal view; larva. 30, dorsal view.



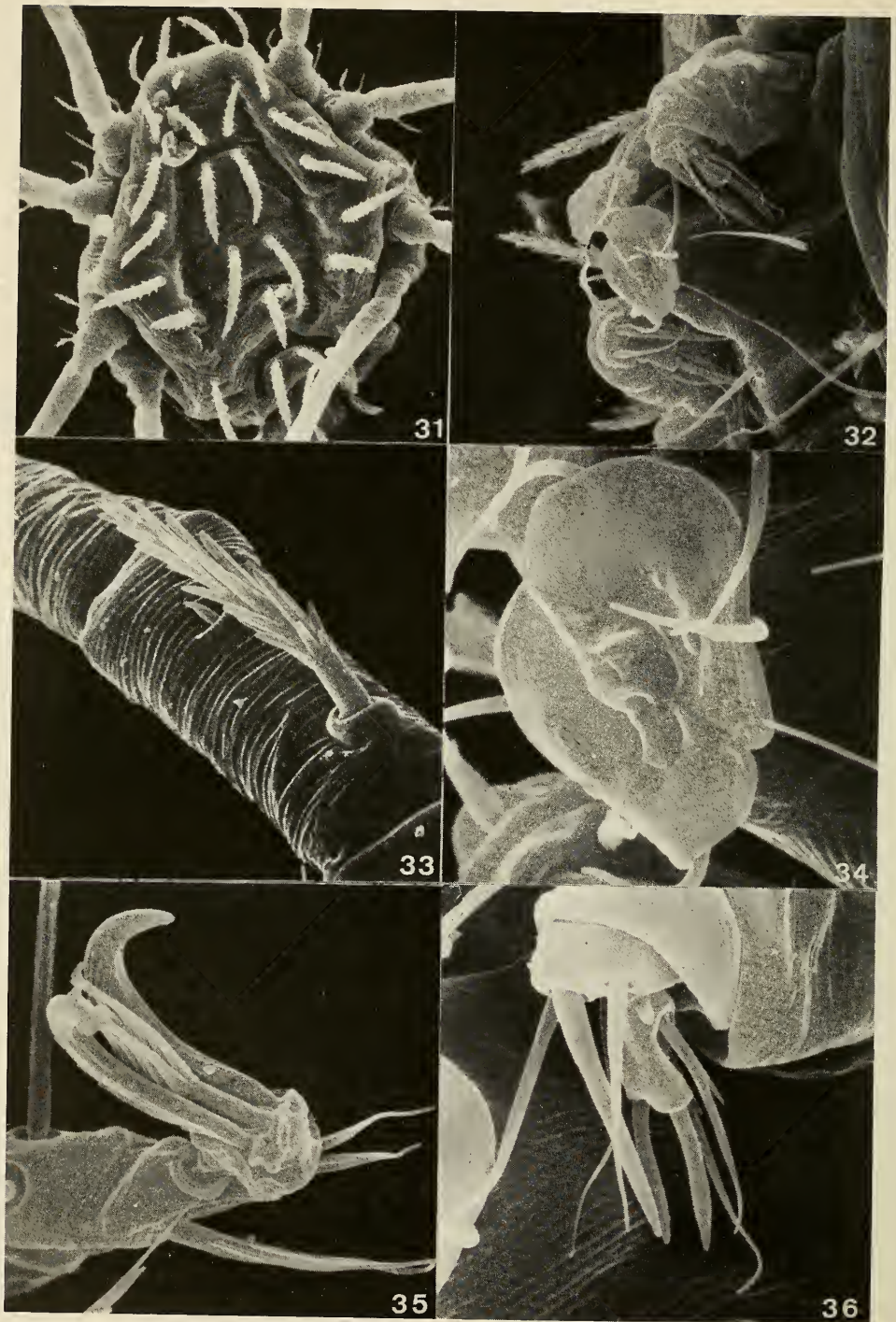

Figs 31—36. *Decaphyllobius gersoni* spec. nov., protonymph. 31, dorsal view; 32, venter of gnathosoma; 33, genu I; 34, rostrum; 35, apotele IV; 36, pedipalp. 31, magnification 430 ×; 32, 2000 ×; 33, 3400 ×; 34, 7000 ×; 35/36, 5000 ×.

**Tillandsobius** gen. nov.

Type species: *Neophyllobius floridensis* McGregor, 1950; by present designation.

Dorsum with 15 pairs of setae.  $L_1$  and  $l_2$  are situated closer to each other than  $l_2$  and  $l_3$ .  $Mc_1$  setae are placed close behind the line across bases of  $l_2$ .

The four peritremata consist of two almost complete loops. Trochanters I—IV each with one seta. Genual setae short. Tibial counts 8-7-6-6. All tibiae each with a distal solenidium. Tarsi I and II each with a subbasical solenidium. Tarsi I and II each with two setae which are not both placed in a ventral position, see figure 1c. Tarsi III and IV each with one mid-ventral seta. Palptibiae with three setae and one sword-like seta. Palptarsi with one seta and two eupathidia and a solenidium.

**Tillandsobius floridensis**

(McGregor) comb. nov.

(figs. 37—45)

*Neophyllobius floridensis* McGregor, 1950: 61.

Female: Body length 285 (285—305)  $\mu\text{m}$ , width 205 (205—235)  $\mu\text{m}$ . Length of legs: 345 (345—375); 285 (285—295); 310 (310—360); 350 (350—375)  $\mu\text{m}$ . Six pairs of *mc*: 20 (20); 15 (15—20); 15 (15—20); 20 (20—25); 20 (20—30); 20 (20—30)  $\mu\text{m}$ . Nine pairs of *l*: 30 (30—35); 20 (20—30); 15 (15—20); 15 (15—20); 20 (20—30); 20 (20—25); 20 (20—25); 20 (20—30); 20 (15—25)  $\mu\text{m}$ . Inter-setal distances:  $l_1$ - $l_2$ ;  $l_2$ - $l_3$ ;  $l_3$ - $l_4$  = 10; 35; 30  $\mu\text{m}$ . Leg setation: coxae 3-1-2-2, trochanters 1-1-1-1, femora 4-3-2-2, genua 1-1-1-1, tibiae 8-7-6-6, tarsi 10-10-7-7.

Pedipalp setation: trochanter 0, femur 2, genu 1, tibia 3 + 1 sword-like seta, tarsus 1 + 2 eupathidia.

$Mc_1$  setae are placed behind the line across bases of  $l_2$ .

Anterior two thirds of dorsum outlined by a narrow band of coarse striae, other bands of coarse striae on the dorsum are between  $l_7$ - $l_7$  and between  $l_8$ - $l_8$ , but the latter does not touch the  $l_8$  setae; rest of posterior part of dorsum also covered with finer longitudinal striae; whole dorsum irregularly punctate. Tarsi I and II with two ventral setae, not in a line with each other but variously spaced. Tarsi III and IV with only one mid-ventral seta.

Male: smaller than female:  $Mc_6$  shortened in length. Only the male solenidium could be observed on each tarsi I and IV, because other tarsi

were broken off. There are two solenidia on the distal end of tibia I.

Protonymph: Six pairs of *mc*. Nine pairs of *l*. Setation of legs: coxae 3-1-2-0, trochanters 1-1-1-0, femora 3-2-1-1, genua 1-1-1-1, tibiae 4-4-4-2, tarsi 1-1-1-1, medio-ventral. Distal parts of tarsi indistinct.

Larva: Five pairs of *mc*. Nine pairs of dorso-laterals. Setation of legs: coxae 2-0-0, trochantera 0-0-0, femora 2-2-1, genua 1-1-1, tibiae 2-2-2, tarsi 1-1-1, medio-ventral. Distal parts of tarsi indistinct. The coarse striation band occurs transversad behind  $mc_3$  instead of behind  $mc_4$  as in the adult.

Remarks. On one side of a paratype  $\delta$  (in USNM) two mid-ventral setae are present on tarsus III, but only on one side. One paratype  $\text{f}$  (in UMC) also has two mid-ventral setae on one side of tarsus III.

Material examined: Holotype  $\text{f}$ , USA, Florida, Duval County, Dupont road, Spanish moss, 9.ii.1948, D. C. Thurman (USNM no. 1897). Paratypes: allotype  $\delta$  and 2  $\delta$ , same slide and data as for the holotype (USNM no. 1897); 1  $\text{f}$  and 1 larva, USA, Louisiana, St. Landry Parish, two mi. N. Melville, Spanish moss, 2.i.1972, L. Dureseau (UMC); 2 protonymphs, USA, Florida, Haines City, Spanish moss under Australian pine, 22.iii.1968, H. L. Greene (DCDG).

**Tycherobius** gen. nov.

Type species: *Neophyllobius lombardinii* Summers & Schlinger, 1955; by present designation.

Dorsum with nine pairs of *l* setae. Five pairs of *mc* setae,  $mc_2$ - $mc_6$  (only *Neophyllobius rhytis* Chaudhri has six pairs of *mc* setae; *Tycherobius virginiensis* comb. nov. has five pairs, plus a single  $mc_1$  seta). The four peritremata consist of two almost complete loops. Trochanters I—IV each with one seta. Tibiae with 9-8-7-7 setae, scattered all over the segment. All tibiae with a distal solenidium. Tarsi I and II each with a subbasical solenidium. The tarsi are skittle-shaped (fig. 1d). Tarsi I and II each with two variously spaced setae (fig. 1d). Tarsi III and IV only with one medial seta. Palptibiae with three setae and a sword-like seta. Palptarsi with one or two setae, one eupathidium and a solenidium.

Key to the species of the genus *Tycherobius*

- Five pairs of *mc* setae; coarse transverse striae banded behind  $mc_2$  . . . . . 2



- More than five pairs of *mc* setae . . . . . 5
- 2.  $Mc_4$  approx. same length of  $mc_3$  . . . . . 3
- . . . . . *T. lombardinii* comb. nov.
- $Mc_4$  shorter in length than  $mc_3$  . . . . . 3
- 3.  $Mc_4$  approx.  $\frac{1}{2}$  of the length of  $mc_3$  . . . . . 4
- $Mc_4$  approx.  $\frac{1}{4}$  of the length of  $mc_3$  . . . . . 4
- . . . . . *T. superbus* comb. nov.
- 4. Palptarsi with one seta;  $l_3$  shorter than  $l_1$  . . . . . 3
- . . . . . *T. stramenticola* spec. nov.
- Palptarsi with two setae;  $l_3$  longer than  $l_1$  . . . . . 3
- . . . . . *T. polonicus* spec. nov.
- 5. Eleven *mc* setae,  $mc_1$  represented by an unpaired seta; coarse transverse striae banded behind  $mc_5$  . . . . . *T. virginiensis* comb. nov.
- Six pairs of *mc* setae . . . *T. rhytis* comb. nov.

### **Tycherobius lombardinii**

(Summers & Schlinger) comb. nov.  
(figs. 46—49)

*Neophyllobius lombardinii* Summers & Schlinger, 1955: 550, 551, 560; MacDaniel, 1979: 202.

Female: Body length 280 (285)  $\mu\text{m}$ , width 235 (240)  $\mu\text{m}$ . Length of legs: 625 (570); 520 (475); 560 (530); 645 (610)  $\mu\text{m}$ . Five pairs of *mc*: 185 (170); 170 (165); 155 (100); 45 (45); 40 (35)  $\mu\text{m}$ . Nine pairs of *l*: 85 (70); 55 (40); 45 (35); 35 (30); 70 (55); 40 (30); 55 (40); 40 (40); 40 (35)  $\mu\text{m}$ . Inter-setal distances:  $l_1$ - $l_2$ ;  $l_2$ - $l_3$ ;  $l_3$ - $l_4$  = (30); 30/35; 60  $\mu\text{m}$ ). Leg setation: coxae 3-1-2-2, trochanters 1-1-1-1, femora 4-3-3-2, genua 1-1-1-1, tibiae 9-8-7-7, tarsi 10-10-7-7. Pedipalp setation: trochanter 0, femur 2, genu 1, tibia 3 + 1 sword-like seta, tarsus 2 + 1 eupathidium. From the outer margin a band of coarse striae runs mediad behind  $l_5$  and curves antieriad behind  $mc_2$ , to rejoin the margin behind  $l_5$ .

Similar bands behind  $l_7$ - $mc_3$ - $l_7$ ,  $l_7$ - $mc_4$ - $l_7$  and  $l_8$ - $mc_5$ - $l_8$ . The members of the pair of setae, situated near the tips of the tarsi, vary considerably in length. The length of setae on femora II and III is characteristic of this species.  $Mc_2$ ,  $mc_3$  and  $mc_4$  long and  $mc_5$  and  $mc_6$  short. The dorsal setae are strongly serrated.

Male: Unknown.

Material examined: Paratypes: ♀, USA, California, Glendale, oak leaf mold, 1.i.1951, E. I. Schlinger (USNM no. 3); ♀, USA, California, The Gavilan, Riverside.

Other published material: Holotype ♀, USA, California, Glendale, oak leaf mold, 1.i.1951, Schlinger (USNM no. 2200). Paratypes: 2 ♀, with same data as holotype; 11 ♀, USA, Cali-

fornia, The Gavilan, Riverside, 17.v.1951, E. I. Schlinger (USNM).

Remarks. McDaniel (1979, fig. 387) depicted a species with different body and leg setation as that shown in the original description.

*T. lombardinii* can be distinguished from other members of this genus by the strongly serrated body setae and the relative length of the *mc* setae:  $mc_2$ ,  $m_3$  and  $mc_4$  long,  $mc_5$  and  $mc_6$  short. Another distinctive feature is the length of the setae on femora II and III.

### **Tycherobius superbus**

(Canestrini) comb. nov.

*Neophyllobius superbus* Canestrini, 1889: 523—524; Canestrini, 1890: 459, 460, Tav. 39, fig. 44, Tav. 40, fig. 39; Berlese, 1894: fasc. 71, Tav. 3; Berlese, 1900: 289.

Female: Body length 270—290  $\mu\text{m}$ , width 220  $\mu\text{m}$ . Length of legs: 500  $\mu\text{m}$ . Five pairs of *mc*:  $mc_2$  = 140  $\mu\text{m}$ ,  $mc_3$  = 115  $\mu\text{m}$ . Nine pairs of *l*. Leg setation: coxae ?, trochanters 1-1-1-1, femora 3-3-2-2, genua 1-1-1-1, tibiae 9-8-7-7, tarsi ? Pedipalp setation: trochanter 0, femur 2, genu 1, tibia ? + 1 sword-like seta, tarsus ? + ? (indistinct).

$Mc_2$  and  $mc_3$  long,  $mc_4$  of moderate length,  $mc_5$  and  $mc_6$  very short. The most proximal seta on femur IV does not reach the genu.

Male: Berlese (1894, 1900) mentioned a male, having five setae on femur I. It is probably a male of a different species.

Known material: Holotype ♀, Italy, Padova, Trentino, of unknown date. Paratypes: several ♀ and ♂; only one slide at ISZA [not examined].

Remarks. No material of this species was available for study. The description is based on the papers of Canestrini and Berlese, and by information provided by Dr. F. Peggazzano (ISZA). According to Canestrini (1889) the female has three setae on femur I, and the male five setae. However, it is an inconsistency if the numbers of setae on femur I are different in both sexes. Femur III further has two setae which is in contrast to the three found in other members of the genus.

*T. superbus* is characterized by having  $mc_2$  and  $mc_3$  long,  $mc_4$  of moderate length and  $mc_5$





Figs. 37—40. *Tillandsobius floridensis* (McGregor) comb. nov. ♀. 37, pedipalp; 38, dorsal seta; 39, coxae I—IV; 40, dorsal view.

and  $m_6$  very short. The most proximal seta on femur IV does not reach the genu, as in *T. lombardini*, *T. stramenticola* spec. nov. and *T. polonicus* spec. nov. Figure 19 (page 33) by Livshits & Mitrofanov (1980), is not of *T. superbus*, because there are six pairs of  $mc$  and a different number of tibial and tarsal setae.

***Tycherobius stramenticola* spec. nov.**  
(figs. 50—54)

Female: Body length 250  $\mu\text{m}$ , width 225  $\mu\text{m}$ . Length of legs 560; 420; 515; 610  $\mu\text{m}$ . Five pairs of  $mc$ : 180; 155; 70; 70; 35  $\mu\text{m}$ . Nine pairs of  $l$ : 80; 35; 60; 25; 60; 40; 40; 35; 35  $\mu\text{m}$ . Inter-setal

distances:  $l_1-l_2$ ;  $l_2-l_3$ ;  $l_3-l_4 = 30$ ; 35; 45/50  $\mu\text{m}$ . Leg setation: coxae 3-1-2-2, trochanters 1-1-1-1, femora 4-3-3-2, genua 1-1-1-1, tibiae 9-8-7-7, tarsi 10-10-7-7.

Pedipalp setation: trochanter 0, femur 2, genu 1, tibia 3 + 1 sword-like seta, tarsus 1 + 1 eupathidium. Bands of coarse striae like those of *T. lombardini* occur on the dorsum.  $Mc_2$  and  $mc_3$  long,  $mc_4$ ,  $mc_5$  of moderate length and  $mc_6$  short.

The most distal seta on femur II is very short. Palptarsus only with one seta and one eupathidium.

Male: Unknown.

Type material: Holotype ♀, Israel, Mount Carmel, in pine litter, 12.xii.1974, U. Gerson (HUJ no 2750).

Remarks: *T. stramenticola* differs from *T. polonicus* spec. nov. in having only one seta on the palptarsus.  $L_3$  is much shorter than  $l_1$ . The  $mc$  setae differ from those of *T. polonicus* spec. nov. and *T. lombardini*.

#### *Tycherobius polonicus* spec. nov.

(figs. 55—60)

*Neophyllobius superbus*; Kuznecov & Livshits, 1979: 82, 101. Misidentification.

Female: Body length 320  $\mu\text{m}$ , width 295  $\mu\text{m}$ . Length of legs: 615; 500; 540; 655  $\mu\text{m}$ .

Five pairs of  $mc$  setae: 235; 205; 95; 85; 35  $\mu\text{m}$ . Nine pairs of  $l$ : 80; 55; 80; 30; 70; 60; 55; 30; 30  $\mu\text{m}$ . Inter-setal distances:  $l_1-l_2$ ;  $l_2-l_3$ ;  $l_3-l_4 = 25$ ; 40; 60  $\mu\text{m}$ . Leg setation: coxae 3-1-2-2, trochanters 1-1-1-1, femora 4-3-3-2, genua 1-1-1-1, tibiae 9-8-7-7, tarsi 10-10-7-7. Pedipalp setation: trochanter 0, femur 2, genu 1, tibia 3 + 1 sword-like seta, tarsus 2 + 1 eupathidium. Bands of coarse striae like those of *T. lombardini* present on dorsum. The two anteriolateral setae on femur III are short, more separate and not touching each others bases as is the case in *T. lombardini* and *T. stramenticola*.  $L_3$  are long, subequal to  $l_1$ .  $Mc$  setae with blunt-tipped spines.

Male: Unknown

Type material: Holotype ♀, Poland, locality, host and date unknown, M. Kaliszewski (UAM 10. S/6 R626).

Remarks. *T. polonicus* resembles *T. stramenticola*. It differs from the latter by having two short anterior setae on femur III which are

more widely spaced than those of the latter species.  $L_3$  as long as  $l_1$  while in *T. stramenticola*  $l_3$  is much shorter than  $l_1$ . The palptarsus has two setae instead of one as in *T. stramenticola*.

The specimen identified by Kuznecov & Livshits (1979) as *T. superbus* appears to be *T. polonicus*.  $Mc$  setae in *T. polonicus* are different from those of other *Tycherobius* spp.

#### *Tycherobius virginienis* (McGregor) comb.

nov.

(figs. 61—66)

*Neophyllobius virginienis* McGregor, 1950: 69, 70.

Female: Body length 295 (305)  $\mu\text{m}$ , width 255 (360)  $\mu\text{m}$ . Length legs: 500 (470); 390 (375); 445 (445); 515 (515)  $\mu\text{m}$ . Six pairs of  $mc$ : 2 (3); 3 (3); 3 (3); 3 (3); 30 (25); 30 (30)  $\mu\text{m}$ . Nine pairs of  $l$ : 55 (55); 35 (40); 30 (35); 30 (35); 40 (45); 35 (40); 35 (40); 35 (35); 30 (30)  $\mu\text{m}$ . Inter-setal distances:  $l_1-l_2$ ;  $l_2-l_3$ ;  $l_3-l_4 = 40$ ; 10; 55  $\mu\text{m}$ . Leg setation: coxae 3-1-2-2, trochanters 1-1-1-1, femora 4-3-3-2, genua 1-1-1-1, tibia 9-8-7-7, tarsi 10-8-7-7. Pedipalp setation: trochanter 0, femora 2, genua 1, tibia 3 + 1 sword-like seta, tarsi 1 + 1 eupathidium.

From the outer margin a band of coarse striae runs medially behind  $l_8$  and anteriorly in a curve behind  $mc_5$ , to rejoin the margin behind  $l_8$ . The rest of the dorsum is covered with a fine tortuous striation. Only a single centrally located  $mc_1$  seta is present and situated immediately behind  $l_1$ .  $Mc_2$  setae situated far away from  $mc_1$ , in line with  $l_4$ .  $Mc_3$  setae more separated from each other than the other  $mc$  pairs.  $Mc_5$  located close to each other whereas  $mc_6$  are contiguous.  $Mc_{1-4}$  can be vestigial as a consequence of mutilation.

The distance between  $l_2$  and  $l_3$  is very short in comparison with the other *Tycherobius* spp. and they are nearby contiguous.

Male: Unknown.

Material examined: "Cotype" ♀, USA, Virginia, Arlington, from sample E-7483, xi.1938, F. Andre (USNM no 1748). 1 ♀, USA, Florida, Lake Placid, in sand-pine litter, 16.xii.1964, M. H. Muma & H. L. Greene (DCDG).

Other published material: "Cotype" ♀, USA, Virginia, Arlington, second slide from sample E-7483, xi.1938, F. Andre (USNM no 1748).

Remarks. The unpaired  $mc_1$  seta, the shorter and different positioned dorsal setae, the place of the only coarse transversal striae bandage and eight setae on tarsus II, separate this species from other *Tycherobius* spp.



Figs. 41—45. *Tillandsobius floridensis* (McGregor) comb. nov. ♂. 41, dorsal view; 42, peritremata; protonymph. 43, dorsal view; 44, dorsal seta; larva. 45, dorsal view.





Figs. 46—49. *Tycherobius lombardinii* (Summers & Schlinger) comb. nov., ♀. 46, pedipalp; 47, coxae I and II; 48,  $l_5$  seta; 49, dorsal view.

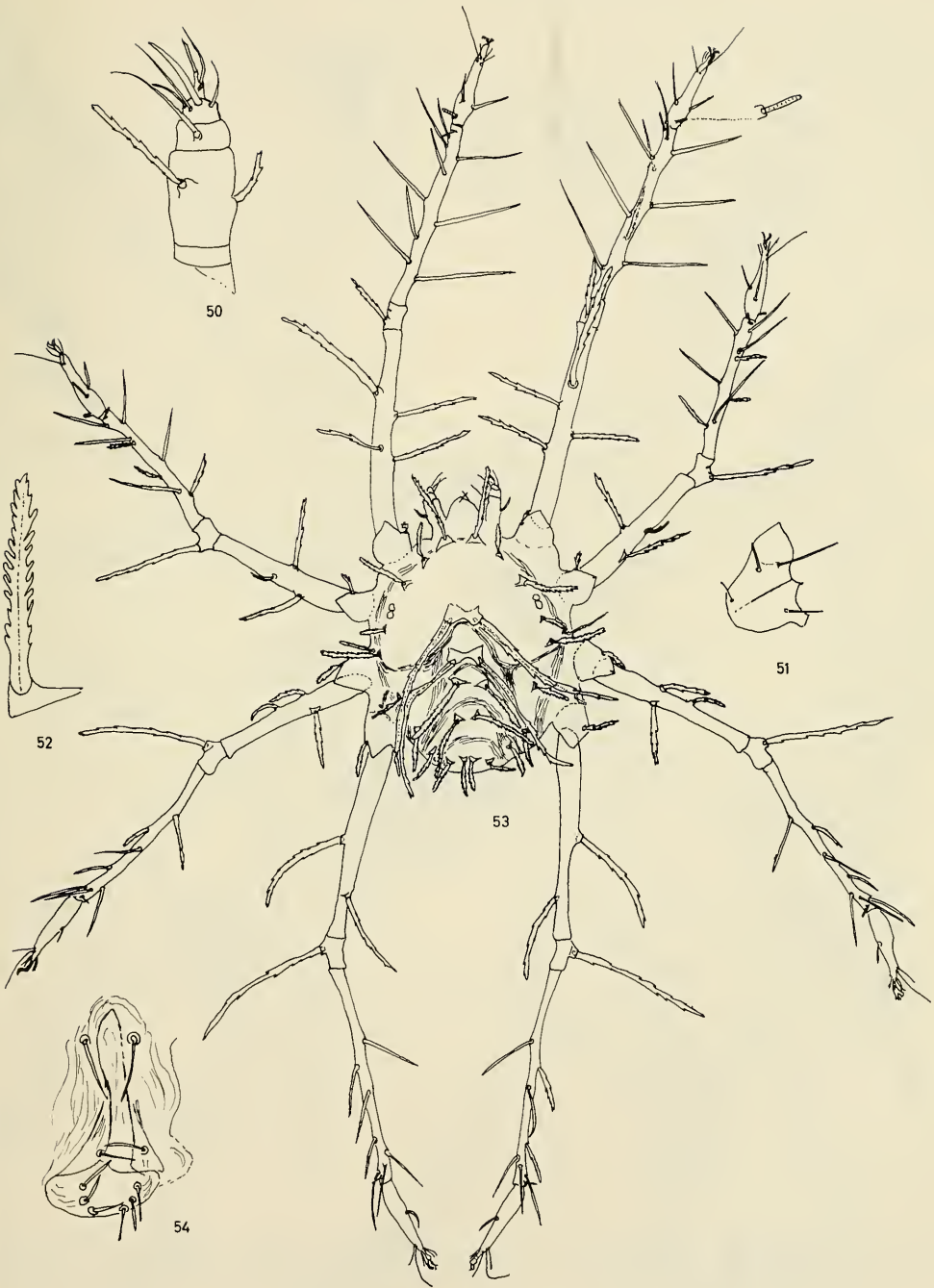

Figs. 50—54. *Tycherobius stramenticola* spec. nov., ♀. 50, pedipalp; 51, coxae I and II; 52,  $l_5$  seta; 53, dorsal view; 54, genital-anal region.

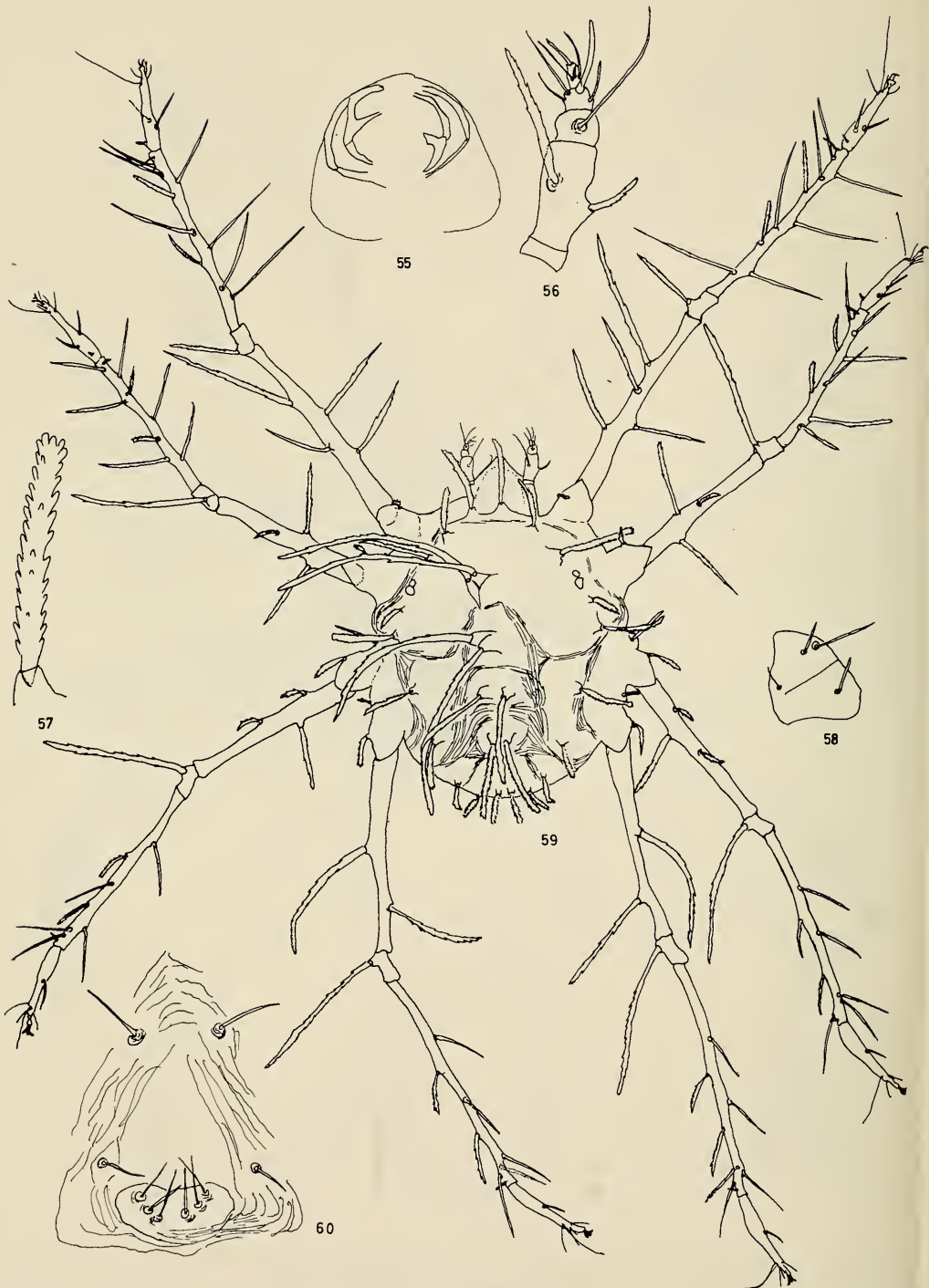

Figs. 55—60. *Tycherobius polonicus* spec. nov. ♀. 55, peritremata; 56, pedipalp; 57,  $l_5$  seta; 58, coxae I and II; 59, dorsal view; 60, genital-anal region.



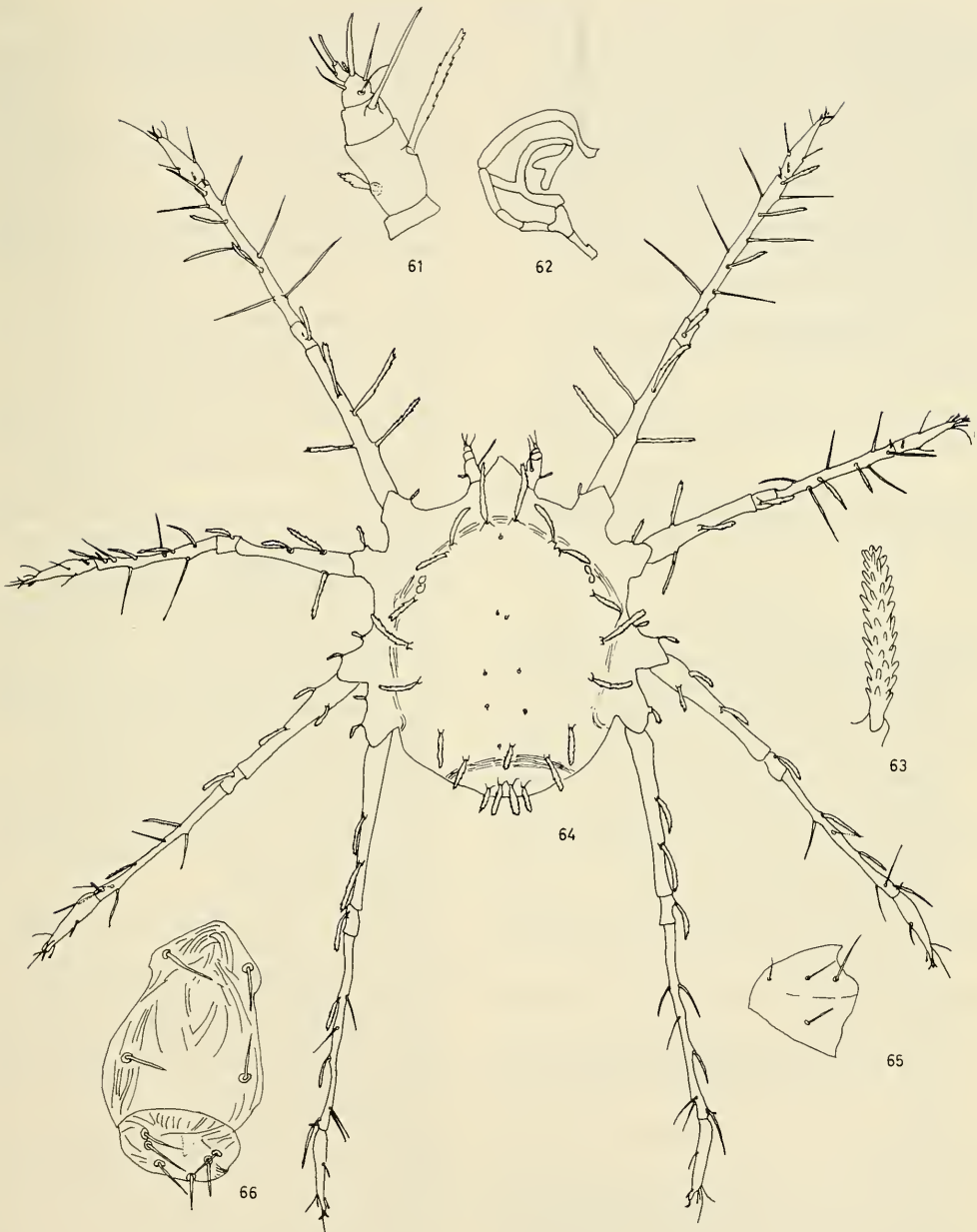

Figs. 61—66. *Tycherobius virginiensis* (McGregor) comb. nov., ♀. 61, pedipalp; 62, left part of peritremata; 63,  $l_5$  seta; 64, dorsal view; 65, coxae I and II; 66, genital-anal region.

The following species is tentatively assigned to *Tycherobius*. Confirmation requires study of the type series.

*Neophyllobius rhytis* Chaudhri 1974: 190—191, fig. 83. Type-material: holotype ♀, Pakistan, 3 mi. W. Hyderabad, on unidentified host-plant no. 4/71, 12.xi.1971, W. M. Chaudhri (DEUAL). Paratype ♀, Pakistan, 2 mi. N. Balakot, 3500, *Hedera himalaica*, 13.vi.1971, W. M. Chaudhri (DEUAL).

This species has six pairs of *mc* setae.

### Neophyllobius Berlese, 1886

*Neophyllobius* Berlese, 1886

Type species: *Neophyllobius elegans* Berlese, 1886.

The species of the genus *Neophyllobius* will be described in separate papers in the near future.

### REFERENCES

- Alberti, G. & R. Ehrnsberger, 1977. Rasterelektronenmikroskopische Untersuchungen zum Spinnvermögen der Bdelliden und Cunaxiden (Acari, Prostigmata). — *Acarologia* 19: 55—61.
- Atyeo, W. T., 1961. The taxonomic position of the genus *Neophyllobius* Berlese, 1886 (Acarina, Caligonellidae) with the description of a new genus and species. — *Acarologia* 3: 153—158.
- Atyeo, W. T., 1963. New and redescribed species of Raphignatidae (Acarina) and a discussion of the chaetotaxy of the Raphignathoidea. — *J. Kans. ent. Soc.* 36: 172—186.
- Baker, E. W. & G. W. Wharton, 1952. An introduction to Acarology. — MacMillan Company, New York: 465 pp + xii.
- Berlese, A., 1886. Acari dannosi alle piante coltivate. Padova: 31 pp.
- Berlese, A., 1887—1894. Acari, Myriapoda et Scorpiones hucusque in Italia, reperta. Padova 34 no 2, 10-i-1887; 34 no 5, 10-i-1887; 71 no 3, 20-iii-1894.
- Berlese, A., 1900. Gli Acari agrari, Riv. Pat. Veg., 8: 288—289.
- Bolland, H. R., 1983. A description of *Neophyllobius aesculi* n. sp. and its developmental stages (Acari: Camerobiidae). — *Ent. Ber., Amst.* 4: 42—47.
- Canestrini, C., 1889. Prospetto dell' Acarofauna Italiana. Famiglia dei Tetranychini. — *Atti. Reale Ist. Ven. Sci., Let. Art.* (ser. 6), 7: 491—537.
- Canestrini, C., 1890. Published separately under title: — *Prospetto dell' Acarofauna Italiana* 4: 427—540.
- Chaudhri, W. M., 1974. Taxonomic studies of the mites belonging to the families Tenuipalpidae, Tetranychidae, Tuckerellidae, Caligonellidae, Stigmaeidae and Phytoseiidae. — University of Agriculture, Lyallpur Pakistan: 250 pp.
- De Leon, D., 1958. The genus *Neophyllobius* in Mexico (Acarina: Neophyllobiidae). — *Fla Ent.* 41: 173—181.
- De Leon, D., 1959. A new genus of mites occurring in Florida and Mexico (Acarina: Caligonellidae). — *Fla Ent.* 42: 17—19.
- De Leon, D., 1967. Some mites of the Caribbean Area. Part I Acarina on plants in Trinidad; West Indies. (Camerobiidae, Tenuipalpidae, Cheyletidae). — Allen. Press Inc. Lawrence Kansas: 1—66.
- Gerson, U., 1968. Some raphignathoid mites from Israel. — *J. nat. Hist.* 2: 429—437.
- Gerson, U., 1971. The mites associated with Citrus in Israel. — *Israel J. Ent.* VI: 5—21.
- Gerson, U., 1972. A new species of *Camerobia* Southcott, with a redefinition of the family Camerobiidae (Acari-Prostigmata). — *Acarologia* 13: 502—508.
- Gerson, U., 1973. The mites associated with armored scale insects. — *Proc. 3rd Int. Congr. Acarol., Prague, 1971*: 653—654.
- Gerson, U., 1985. Webbing — In: W. Helle & M. Sabelis (editors), *Spider Mites, their Biology, Enemies and Control*, 1A. Elsevier Science Publishers B.V. Amsterdam: 223—232.
- Gerson, U., B. M. O'Conner & M. A. Houck, in prep. Acari. — In: *Armored Scale Insects, their Biology, Natural Enemies and Control*. Elsevier Science Publishers B.V. Amsterdam (in press).
- Geijskes, D. C., 1939. Beiträge zur Kenntnis der europäischen Spinnmilben (Acari: Tetranychidae), mit besonderer Berücksichtigung der niederländischen Arten. — *Meded. Landbouwhogesch. Wageningen* 42: pp. 68.
- Hassan, M. F., 1976. Studies on some prostigmatid predators. — M.Sc. Thesis, Faculty of Agriculture, Cairo University: 70 pp.
- Helle, W., H. R. Bolland, S. H. M. Jeurissen & G. A. van Seventer, 1984. Chromosome data of Actinedida, Tarsonemida and Oribatida. — *Proc. 6th Int. Congr. Acarol., Edingburgh, 198*: 449—454.
- Kethley, J., 1982. Synopsis and classification of living organisms 2 "Acariformes". — McGraw Hill, Inc. S. P. Parker, ed.: 117—146.
- Krantz, G. W., 1970. A manual of Acarology. Oregon State University Book Stores, Corvallis, OR: xi + 335 pp.
- Krantz, G. W., 1978. A manual of Acarology, second edition. Oregon State University Book Stores, Corvallis, OR: viii + 509 pp.
- Kuznecov, N. N. & Livshits, I. Z., 1979. Predatory mites of the Crimea (Acariformes: Bdellidae, Cunaxidae, Camerobiidae). Pests and diseases of forest parks and fruit plantings in the Crimea. — *Trudy gos. nikit. bot. Sada* 79: 52—105. (in Russian).
- Livshits, I. Z. & V. I. Mitrofanov, 1975. Plant inhibiting mites, An illustrated key for families. — *Trudy gos. nikit. bot. Sada* 66: 1—184. (in Russian).

- Livshits, I. Z. & V. I. Mitrofanov, 1980. Methodical instructions for determination of beneficial beetles and mites in the orchards. — Trudy gos. nikit. bot. Sada: pp. 35. (in Russian).
- McDaniel, B., 1979. How to know the mites and ticks. — The Pictured Key Nature Series, Wm. C. Brown Company Publishers, Dubuque, Iowa: viii + 335 pp.
- McGregor, E. A., 1950. Mites of the genus *Neophyllobius*. — Bull. So. Calif. Acad. Sc. 49: 55—70.
- Meyer, M. K. P., 1962. Two new mite predators of red scale (*Aonidiella aurantii*) in South Africa. — S. Afr. J. agr. Sci. 5: 411—417.
- Meyer, M. K. P. & P. A. J. Ryke, 1959. Mites of the superfamily Raphignathoidea (Acarina: Prostigmata) associated with South African plants. — Ann. Mag. nat. Hist. 13: 209—234.
- Richards, A. M., 1962. The oyster-shell scale, *Quadraspidiotus ostreaeformis* (Curtis) in the Christchurch district of New Zealand. — N. Z. J. agric. Res. 5: 95—100.
- Robaux, P., 1975. Observations sur quelques Actinédida (Prostigmates) du sol d'Amérique du Nord, II. Redescription de *Neophyllobius farrieri* De Léon 1958. (Acari; Raphignathoidea; Camerobiidae). — Acarologia 17: 248—256.
- Smiley, R. L. & J. C. Moser, 1968. New species of mites from pine (Acarina; Tarsocheylidae, Eupallopsellidae, Caligonellidae, Cryptognathidae, Raphignathidae and Neophyllobiidae). — Proc. ent. Soc. Wash. 70: 307—317.
- Soliman, Z. R. & M. A. Zaher, 1967. Two new species of the genus *Neophyllobius* (Acarina: Neophyllobiidae). — Bull. Soc. ent. Egypte 51: 27—30.
- Southcott, R. V., 1957. Description of a new Australian Raphignathoid mite, with remarks on the classification of the Trombidiformes (Acarina). — Proc. Linn. Soc. N. S. W. 81: 306—312.
- Summers, F. M., 1966. Key to families of the Raphignathoidea (Acarina). — Acarologia 8: 226—229.
- Summers, F. M. & E. I. Schlinger, 1955. Mites of the family Caligonellidae (Acarina). — Hilgardia 23: 539—561.
- Szabó, P., 1980. *Camerobia australis* Southcott, 1956, new to the fauna of Hungary. — Folia ent. hung. 33: 376. (in Hungarian).
- Womersley, H., 1940. Studies in Australian Acarina, Tetranychidae and Trichadenidae. — Trans. Roy. Soc. S. Australia 64: 233—265.
- Wood, T. G., 1964. New records of terrestrial Prostigmata from New-Zealand. — N. Z. Ent. 3: 39—40.
- Zaher, M. A. & E. A. Gomaa, 1979. Genus *Neophyllobius* in Egypt with description of three new species (Prostigmata-Neophyllobiidae). — Int. J. Acarol. 5 (2): 123—130.

(Author's address: Laboratory of Experimental Entomology, University of Amsterdam, Kruislaan 302, 1098 SM Amsterdam, The Netherlands.)















QL  
461  
T568  
Ent.

# TIJDSCHRIFT VOOR ENTOMOLOGIE

UITGEGEVEN DOOR

DE NEDERLANDSE ENTOMOLOGISCHE VERENIGING



## INHOUD

R. V. HENSEN. — Revision of the subgenus *Prosceliphron* Van der Vecht (Hymenoptera, Sphecidae), pp. 217—261, figs. 1—118.





# REVISION OF THE SUBGENUS *PROSCELIPHRON* VAN DER VECHT (HYMENOPTERA, SPHECIDAE)

BY

R. V. HENSEN

*Rijksmuseum van Natuurlijke Historie, Leiden*

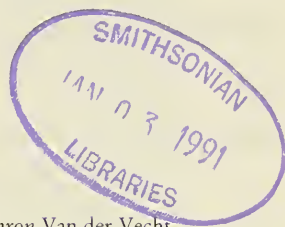

## ABSTRACT

This paper deals with the species belonging to the subgenus *Prosceliphron* Van der Vecht, 1968 (Hymenoptera, Sphecidae: *Sceliphron* Klug). Eleven species are recognized, and ten additional subspecies. The status of eight taxa is changed in comparison to the lists of Bohart and Menke (1976). Three new subspecies are described: *S. deforme femorale*, *S. rufopictum kalshoveni*, and *S. rufopictum laticinctum*. Lectotypes are designated for twelve species-group names. The revision comprises keys to the species and subspecies, descriptions of all taxa, maps of the distribution, and a phylogenetic analysis of characters, resulting in a cladogram.

## CONTENTS

Introduction .....	217
Biology .....	218
The subgenus <i>Prosceliphron</i> Van der Vecht .....	218
Phylogeny .....	219
Key to the species of the subgenus <i>Prosceliphron</i> Van der Vecht .....	222
References .....	259
Index .....	261

## INTRODUCTION

This paper is the second part of the "Studies in the *Sceliphronini*" which was started in 1968 with the "Revision of the nominate subgenus *Sceliphron* Latreille (recte: Klug) (Hymenoptera, Sphecidae)" by Van der Vecht & Van Breugel. The present paper deals with the subgenus *Prosceliphron* Van der Vecht, and thus completes the revision of the genus *Sceliphron*. I have based my work to some extent on material gathered by Dr Van der Vecht, during and after his work on *Sceliphron* s.s., and I have taken advantage of his personal notes on the species and subspecific forms.

Terminology. — I generally have applied the morphological terminology of Bohart and Menke (1976), which is the same as that used in the revision of the nominate subgenus. However, I have replaced the terms "thorax" by "mesosoma", and "abdomen" by "metasoma", following Michener (1944) and many other workers on Hymenoptera in this respect. For the description of surface sculpture the terminology of Eady (1968) has been followed.

Two structures of morphological importance appeared not to be named yet. The "post-antennal tubercles" are elevations on the frons, just above the antennal insertions, which vary in shape and size. The "volsellar plate" is a median plate-like structure in the genitalia of the male, attached ventrally at the bases of the volsellae. The fact that the taxonomic importance of this structure has never received much attention is probably due to the common practice of illustrating only one half of the genital apparatus.

With regard to colour-patterns I have considered it unnecessary to give lengthy descriptions of all taxa, since Kohl's work (1918) is rather complete in this respect; full descriptions are therefore only given for taxa which are not mentioned in Kohl's work.

In order to give some of the specific characters a more exact basis, I have found it useful to express these in a number of ratios. Certain body measurements were made on a selection of specimens of each species, including the extremes as far as possible. The ratios are defined and abbreviated as follows.

- IFR Interocular distance across the vertex, divided by the length of the first flagellomere.
- PTR Length of the petiolus (b in fig. 1), divided by the length of the hind tibia.
- PR Petiolus ratio, see fig. 1: a divided by b.
- TR Tergite ratio, see fig. 1: c divided by d.
- SR Segment ratio, see fig. 1: d divided by b.

The material used for this study is for the most part preserved in the collections of the following museums:

BPBM	Bernice P. Bishop Museum, Honolulu, Hawaii, USA
BMNH	British Museum (Natural History), London, England
CH	Collection Hensen, Utrecht, The Netherlands
DEI	Former Deutsche Entomologische Institut, now Institut für Pflanzenschutzforschung, Eberswalde, GDR
IRSN	Institut Royal de Sciences Naturelles, Brussels, Belgium
LACM	Los Angeles County Museum, Los Angeles, Calif., USA
TMA	Természettudományi Múzeum, Budapest, Hungary
MCZ	Museum of Comparative Zoology, Cambridge, Mass., USA
RMNH	Rijksmuseum van Natuurlijke Historie, Leiden, The Netherlands
MNHN	Musée National d'Histoire Naturelle, Paris, France
MZU	Museo di Zoologia della Università, Torino, Italy
NMW	Naturhistorisches Museum Wien, Vienna, Austria
NRS	Naturhistoriska Riksmuseet, Stockholm, Sweden
OUM	Oxford University Museum, Oxford, England
USNM	United States National Museum, Washington D.C., USA
UZM	Universitetets Zoologiske Museum, Copenhagen, Denmark
ZIL	Zoologitseskij Institut, Leningrad, USSR
ZMA	Zoologisch Museum, Amsterdam, The Netherlands
ZMB	Zoologisches Museum der Humboldt-Universität, Berlin, GDR.

I am greatly indebted to the curators of these museums, for enabling me to study the material in their care.

I especially wish to thank Dr J. van der Vecht, Putten, and Dr C. van Achterberg, Leiden, for their helpful criticism and valuable remarks, and for the final reviewing of the manuscript; and Dr E. McC. Callan, Canberra, for his permission to publish some of his observations on *S. formosum*.

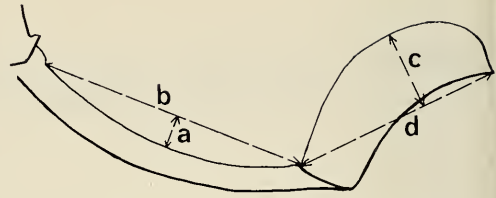

Fig. 1. *Sceliphron deforme* (Smith), first metasomal segment, lateral aspect.

#### BIOLOGY

As discussed by Van der Vecht (1961: 254), biologically, the species of *Prosceliphron* are separated from those of *Sceliphron* s.s. in the way in which they construct their nest. *Sceliphron* s.s. species build their cells against each other, and the whole nest is covered with an extra layer of mud after completion. *Prosceliphron*-species build the cells close to each other, but they remain free, and are not covered by an extra layer of mud. This behaviour has been reported up to now for the following species: *S. rectum* Kohl, *S. curvatum* (Smith), *S. deforme* (Smith), *S. coromandelicum* (Lepelletier) and *S. rufopictum* (Smith). Dr E. McC. Callan, Canberra, Australia (pers. comm.) confirmed this type of behaviour in *S. formosum* (Smith): "The nest was built in a sheltered situation in the garage of my house in Canberra. It comprised five free mud-cells, amphora-shaped, and with a smooth surface, and was not covered by an extra layer of mud (crépissage) applied after completion of the cells. Provisioning was almost exclusively with spiders of the family Salticidae".

#### THE SUBGENUS *PROSCELIPHON* VAN DER VECHT

*Prosceliphron* Van der Vecht, 1968: 192, as subgenus of *Sceliphron* Klug.

Type species: *Sceliphron coromandelicum* (Lepelletier, 1845), by original designation.

The following description is an addition to the generic description by Bohart & Menke (1976: 103—104).

Head. — Lower three-fifths of inner orbits parallel; clypeus of female with a pair of lobes apically, which are continuous with the lateral margin, or separated from it by an angle or incision; clypeus of male with a pair of small apical



Table 1. Synoptic table of character-states in the species of the subgenus *Prosceliphron* Van der Vecht.

Plesiomorphous character-states (0)	Sceliphron s. s.											Apomorphous character-states (●)	
	shestakovi	funestum	rectum	curvatum	deforme	fervens	coromandelicum	rufopictum	murarium	unifasciatum	formosum		
1) Hypostomal carina complete	0	0	●	●	●	●	●	●	●	●	●	●	Hypostomal carina reduced
2) Clypeal lobes not differentiated	●	0	0	0	●	●	●'	●'	●'	●'	●'	●'	Clypeal lobes differentiated (●) Clypeus with lateral incisions (●')
3) First tergite slender	0	0	0	0	●	●	●	0	0	0	0	0	First tergite swollen
4) Clypeus of male laterally emarginate	●	0	●	●	0	0	0	●	●	●	●	●	Clypeus of male laterally rounded
5) Dorsal margin of propodeal orifice narrow	0	0	0	0	0	0	0	0	●	●	●	●	Dorsal margin of propodeal orifice raised
6) Vertex simple	0	0	0	0	0	0	0	0	●	0	0	●	Vertex with tendency to elevation
7) Volsellar plate narrow, oblong	0	?	0	0	●	●	●	●	●'	●'	?	●	Volsellar plate small (●) Volsellar plate triangular (●')
8) Cuspis pubescent	0	?	●	●	0	0	0	0	0	?	0	0	Cuspis without pubescens

lobes, or rounded and medially incised; mandible unidentate; hypostomal carina usually reduced, evanescent about half-way to mandible, but complete in *shestakovi*.

Mesosoma. — Mesoscutum transversely striate to strigose; scutellum longitudinally strigose, striae more or less evanescent anteriorly; mesopleuron strongly sculptured: strigose and punctate or granulate; scrobal sulcus indicated; metapleural sulcus present; metapleuron with variable sculpture; claws of middle and hind legs, and usually those of fore legs with small mesal tooth; propodeum transversely strigose and more or less punctate.

Metasoma. — Petiolus curved, except in *funestum* and *rectum*; sixth sternite of female keeled; male with feebly developed bands of micro-pubescence on fifth and sixth sternite; penis valves ventrally with a row of 10—20 teeth on the inner margin; aedeagus apically rounded; cuspis densely punctate and with long setae, except in *rectum* and *funestum*; head of digitus rounded; gonobasis with more or less distinct tooth ventrally.

#### PHYLOGENY

For the phylogenetic analysis of the genus *Sceliphron* Klug, I have considered *Chalybion* Dahlbom to be its sister-group and consequently the most useful outgroup. The morphological evidence for the sister-group relationship between these genera is rather weak, as pointed out by Bohart & Menke (1976: 83). There are no strict autapomorphies separating the two genera from the remaining Sceliphronini. However, there is a strong biological argument, i.e. the type of prey these genera use. *Sceliphron* and *Chalybion* prey exclusively on spiders, whereas all other Sceliphronini prey on Orthoptera and Dictyoptera. The use of spiders is very rare within the Sphecidae, whereas Orthoptera are a common prey of many Sphecid tribes, including the Sphecini. Thus preying on spiders can be regarded as a synapomorphy of *Sceliphron* + *Chalybion*.

Within this assemblage, *Sceliphron* can be considered a monophyletic group on basis of the following synapomorphies, determined by reference to the other genera of the Sceliphroni-

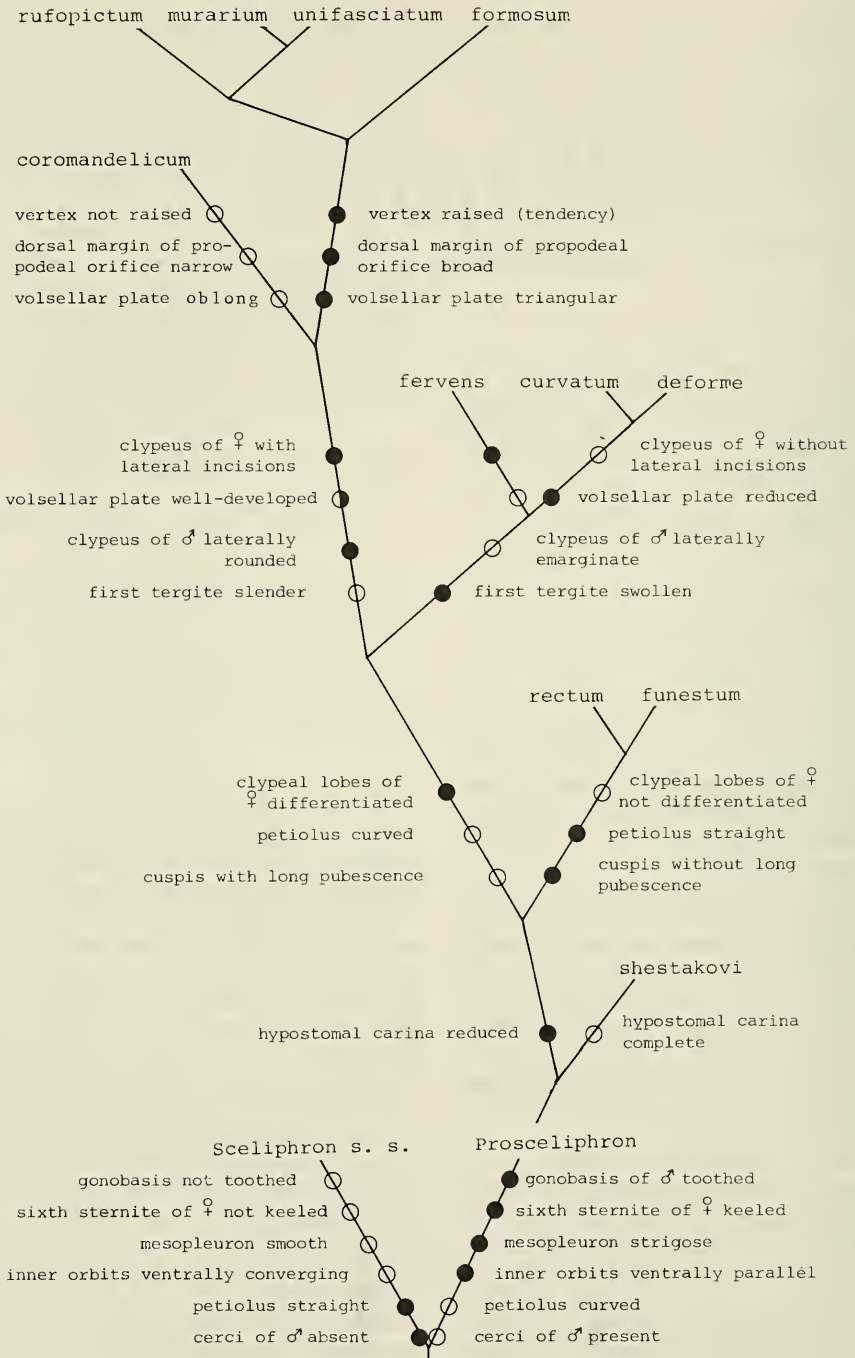

Fig. 2. Cladogram of the species of the subgenus *Prosceliphron* Van der Vecht.

ni. The corresponding plesiomorphous character-states, found in the other Sceliphronini, including *Chalybion*, are given between brackets.

1. Clypeus ventrally untoothed, with broad, flat margin. (Clypeus toothed, without flat margin.)

2. Integument partly bright yellow, particularly the legs and petiolus, usually also part of meso- and metasoma. (Integument black or metallic blue, not partly yellow.)

Within the genus *Sceliphron*, two subgenera can be recognized on basis of the following characters. The plesiomorphous character-state, determined by reference to the outgroup *Chalybion*, is given between brackets.

1. Inner orbits of female essentially straight on lower three-fifth. (Inner orbits ventrally converging.)

2. Mesopleuron strigose, dull. (Mesopleuron punctate, shiny.)

3. Petiolus long and essentially straight. (Petiolus short, curved.)

4. Sixth sternite of female longitudinally keeled. (Sixth sternite of female convex or flat, not keeled.)

5. Eighth tergite of male without cerci. (Eighth tergite of male with cerci.)

6. Gonobasis of male apico-ventrally with a small tooth. (Gonobasis of male untoothed.)

The subgenus *Sceliphron* s.s. has the apomorphous character-states of 3 and 5. The subgenus *Prosceliphron* has the apomorphous character-states of 1, 2, 4 and 6.

The following characters are of taxonomic importance within the subgenus *Prosceliphron*, at the species-level. The plesiomorphous character-states, determined by reference to the outgroup, the sister-group *Sceliphron* s.s., are given between brackets, if the interpretation is unambiguous.

1. Hypostomal carina reduced, ending about half way between the top of the hypostomal cavity and the base of the mandible. (Hypostomal carina complete, ending near base of mandible.)

2. The clypeus of the female. A sequence of three character-states can be recognized; the second state is morphologically a distinct intermediate between the other two. The polarity of the transformation-series however is doubtful.

All three character-states occur in *Sceliphron* s.s. as well:

i) Apical lobes not differentiated from the lateral parts of the free clypeal margin (fig. 4).

ii) Apical lobes differentiated, making an obtuse angle with the rest of the clypeal margin (fig. 33).

iii) Apical lobes separated from the rest of the clypeal margin by lateral incisions (fig. 65).

3. First metasomal tergite swollen (fig. 55). (First metasomal tergite slender.)

4. Ventral clypeal margin of male laterally rounded (fig. 71). (Ventral clypeal margin of male laterally emarginate (fig. 66).)

5. Dorsal margin of propodeal orifice raised into a lamella, trapezoid or rounded in posterior view (fig. 91). (Dorsal margin of propodeal orifice narrow, rounded (fig. 6).)

6. Vertex strongly raised behind anterior ocellus (fig. 100). (Vertex not raised.)

7. i) Volsellar plate reduced (fig. 20). ii) Volsellar plate broadly triangular (fig. 87). (Volsellar plate well-developed, oblong, pointed (fig. 53).)

8. Cuspis without pubescence. (Cuspis with rather long pubescence.)

The distribution of the plesio- and apomorphous character-states among the species is shown in the synoptic table (table 1).

The polarity of the transformation-series in character 2 has been determined by reference to others, in particular the first character. This one seems to be fairly strong: reduction of the hypostomal carina is a unique development within the Sceliphronini. On basis of this character, *S. shestakovi* can be regarded as the sister-group of the remaining species of *Prosceliphron*.

On basis of the data-matrix, the most parsimonious cladogram has been constructed, which is depicted in fig. 2. The four species on the top row have been ordered more or less phenetically, as they show no formal synapomorphies. These species are allopatric, insular taxa from the Indo-Australian area, and may have arisen by rapid, contemporary speciation. In that case it is not astonishing that no synapomorphies could be traced.

The place of *S. fervens* in the cladogram is rather doubtful. In the cladogram of fig. 2 it is placed as the sister-species of *S. curvatum* + *S. deforme*, assuming that homoplasy is present with respect to character 2, the shape of the clypeus of the female, and that character 3, the



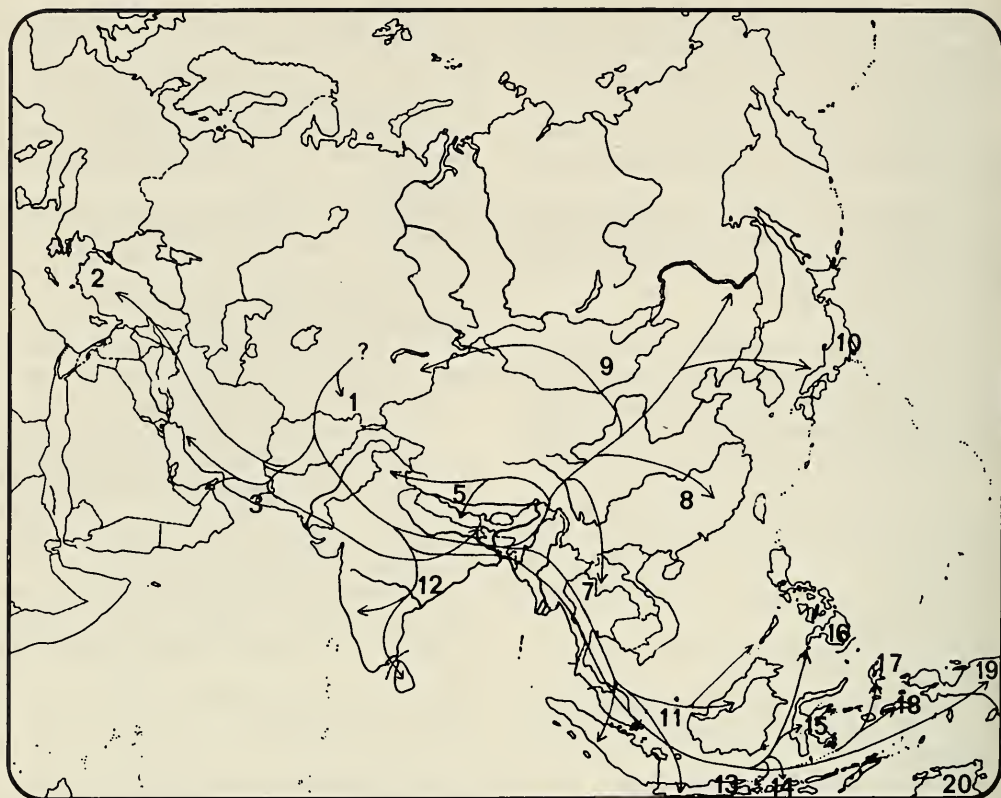

Fig. 3. Hypothetical evolutionary migration of *Prosceliphron* Van der Vecht; the present distribution is indicated by numbers which refer to recent species and subspecies (see figs. 114—118).

swollen first tergite, is a true synapomorphy.

The resulting cladogram is strongly correlated to the current geographic distribution of the species. Species at the base of the cladogram occur in Central and South-Western Asia, while species at the top of the cladogram are found in the Indo-Australian area. Apparently, the zoogeographic history of *Prosceliphron* is a case to which Hennig's progression rule (Wiley, 1981: 288) applies. Under these particular circumstances, it is possible to hypothesize about the migratorial routes the subgenus has followed in the course of its evolution. One of the probable pathways is shown in fig. 3. Obviously, the subgenus has originated in Central Asia, where nowadays *S. shestakovi*, sister-species of the remaining *Prosceliphron* still occurs. Spreading over South and East Asia supposedly took place via the Indian subcontinent. Two lineages of species arrived independently in the Indonesian archipelago, via the Malayan peninsula. The lineage originating from a *S. coromandelicum*-

like ancestor spread over large parts of the archipelago, and reached the Philippines via Celebes, and Australia via New Guinea. A second group probably arrived subsequently, spread over Sumatra and Java, and reached the Southern Philippine island Palawan via Borneo.

KEY TO THE SPECIES OF THE SUBGENUS  
*PROSCELIPHRON* VAN DER VECHT

1. Petiolus in lateral view nearly straight (PR 0.02—0.04), usually longer than hind tibia (PTR ♀ 0.9—1.1; ♂ about 1.1), and apically compressed, about 1.5 times as high as broad (figs. 10, 14, 15); clypeus of ♀ without distinct terminal lobes (fig. 12) . . . . . 2
- Petiolus in lateral view distinctly curved (PR 0.05—0.14), usually shorter (PTR ♀ 0.6—1.0; ♂ 0.8—1.1) and apically not compressed, as high as wide (e.g. figs. 27, 28); clypeus of ♀ variable . . . . . 3
2. Mesosoma with extensive yellow markings:

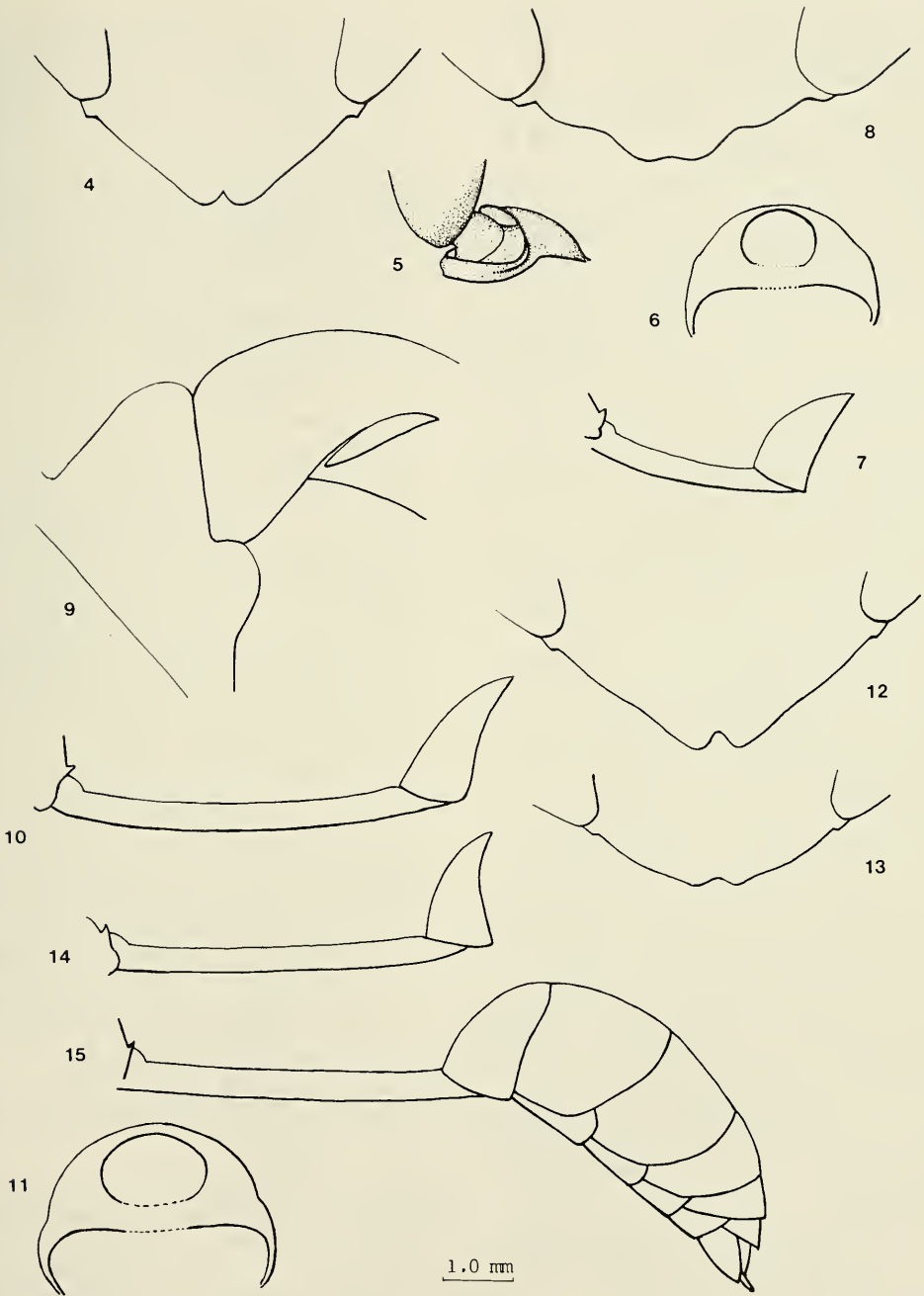

Figs. 4—15. 4—8. *Sceliphron shestakovi* Gussakovskij. 4—7, ♀, USSR, Tadjhikistan. 4, clypeus; 5, antennal insertion; 6, propodeal orifice; 7, first metasomal segment. 8, ♂, USSR, Kirgizia, clypeus. 9—11, *Sceliphron funestum* Kohl. 9, ♀, Greece, pronotum, lateral aspect; 10, ♂, Greece, first metasomal segment; 11, ♀, Turkey, propodeal orifice. 12—15, *Sceliphron rectum* Kohl. 12, ♀, India, Gujarat, clypeus; 13—14, ♂, India, Gujarat, 13, clypeus, 14, first metasomal segment; 15, ♀, Pakistan, metasoma, lateral aspect. 4, 7, 8, 10, 12—15: scale-line; 9: 2.0 × scale-line; 5, 6, 11: 4.0 × scale-line.

- at least with bands on pronotum and scutellum and large spots on the mesopleuron; petiolus yellow; Iran to India . . . . . *rectum* Kohl (p. 228)
- Mesosoma nearly entirely black; petiolus black; Greece, Turkey . . . . . *funestum* Kohl (p. 226)
3. Hypostomal carina runs to base of mandibles; metapleuron finely granulate; petiolus very short (PTR ♀ 0.6—0.7; ♂ 0.8), mainly yellow; all tergites with yellow band; Tadzhikistan and adjacent Soviet Republics . . . . . *shestakovi* Gussakovskij (p. 224)
- Hypostomal carina does not reach base of mandibles; metapleuron punctate or strigose; petiolus longer (PTR ♀ 0.7—1.0; ♂ 0.8—1.1); coloration variable . . . . . 4
4. Mesoscutum dull, irregularly strigose, and with distinct shallow punctation between the striae over its entire surface . . . . . 5
- Mesoscutum comparatively shiny, regularly striate and only laterally and along the admedian line sometimes shallowly punctate . . . . . 6
5. Interocular distance at vertex distinctly longer than first flagellomere (IFR ♀ 1.1—1.2; ♂ 1.1—1.2); fore claws untoothed; clypeus of ♀ without lateral incisions (fig. 25); clypeus of ♂ laterally emarginate (fig. 22); Tadzhikistan to Nepal, Austria . . . . . *curvatum* (Smith) (p. 228)
- Interocular distance shorter (IFR ♀ 0.9—1.1; ♂ 0.9—1.1); fore claws toothed; clypeus of ♀ with lateral incisions (figs. 103, 104); clypeus of ♂ laterally rounded (figs. 105, 106); Australia, New Guinea, Bismarck-Archipelago, Solomon-Islands . . . . . *formosum* (Smith) (p. 255)
6. Petiolus yellow, rest of metasoma black; mesosoma nearly entirely black; India to Malaya . . . . . *coromandelicum* (Lepelletier) (p. 243)
- Petiolus entirely or for the most part black; mesosoma usually with extensive yellow markings . . . . . 7
7. First tergite swollen (TR ♀ 0.22—0.36; ♂ 0.25—0.38) (figs. 36—39); upper margin of propodeal orifice narrow and rounded (figs. 24, 51), usually not translucent . . . . . 8
- First tergite not swollen (TR ♀ 0.13—0.22; ♂ 0.17—0.18) (figs. 76, 78, 80); upper margin of propodeal orifice strongly developed: broad, lamelliform, rounded (fig. 77) or trapezoid (fig. 79), often yellowish or brownish translucent . . . . . 9
8. Forewing at apex with well defined dark spot; only third metasomal tergite with complete yellow band; lower part of subtegular spot, if present, smaller than upper part; clypeus of ♀ with lateral incisions (fig. 49); Southern Thailand to Java, Borneo, Palawan . . . . . *fervens* (Smith) (p. 242)
- Forewing at apex with comparatively ill-defined dark spot; at least fourth and fifth tergite with complete band, or metasoma unbanded; lower part of subtegular spot, if present, larger than upper part; clypeus of ♀ without lateral incisions (figs. 33, 34); Kazakhstan to Japan and Indochina . . . . . *deforme* (Smith) (p. 230)
9. Pubescence of head and mesosoma dark brown; meso- and metasoma without yellow markings; first and second tergites entirely reddish; Ceram, Ambon . . . . . *murarium* (Smith) (p. 254)
- Pubescence of head and mesosoma white or slightly yellowish; metasoma entirely black, without red, or with yellow bands . . . . . 10
10. Mesosoma with extensive yellow markings on pronotum, mesopleuron, scutellum and propodeum (figs. 81—84); pronotal collar comparatively broad in lateral view (figs. 74, 75); Philippines, Celebes, Java and smaller Sunda Islands . . . . . *rufopictum* (Smith) (p. 247)
- Mesosoma with at most small spots on subalar area and faint bands on pronotum and scutellum; (fig. 85); pronotal collar comparatively high and narrow in lateral view (fig. 94); Northern Moluccas . . . . . *unifasciatum* (Smith) (p. 254)

**Sceliphron shestakovi** Gussakovskij  
(figs. 4—8, 114)

*Sceliphron* (*Pelopoeus*) *shestakovi* Gussakovskij, 1928: 4, ♀ — Transcaspia (ZIL; examined).  
*Sceliphron* (*Prosceliphron*) *shestakovi*; Bohart & Menke, 1976: 106.

Type. — The type-specimen I have seen is labelled "Merv, 12.VI.1925, V. Gussakovskij", "*Sceliphron shestakovi* m. sp. typicum unicum, V. Gussakovskij". It has been labelled as the lectotype, but evidently, it is the holotype. The type-locality Merv (= Mary) is situated in the Turkmen SSR, at 37°42' N, 61°54' E.

Description. — Body length: ♀ 12.9—15.0 mm, ♂ 16.9 mm; length of forewing: ♀ 8.7—9.6 mm, ♂ 10.4 mm. Erect pubescence of head



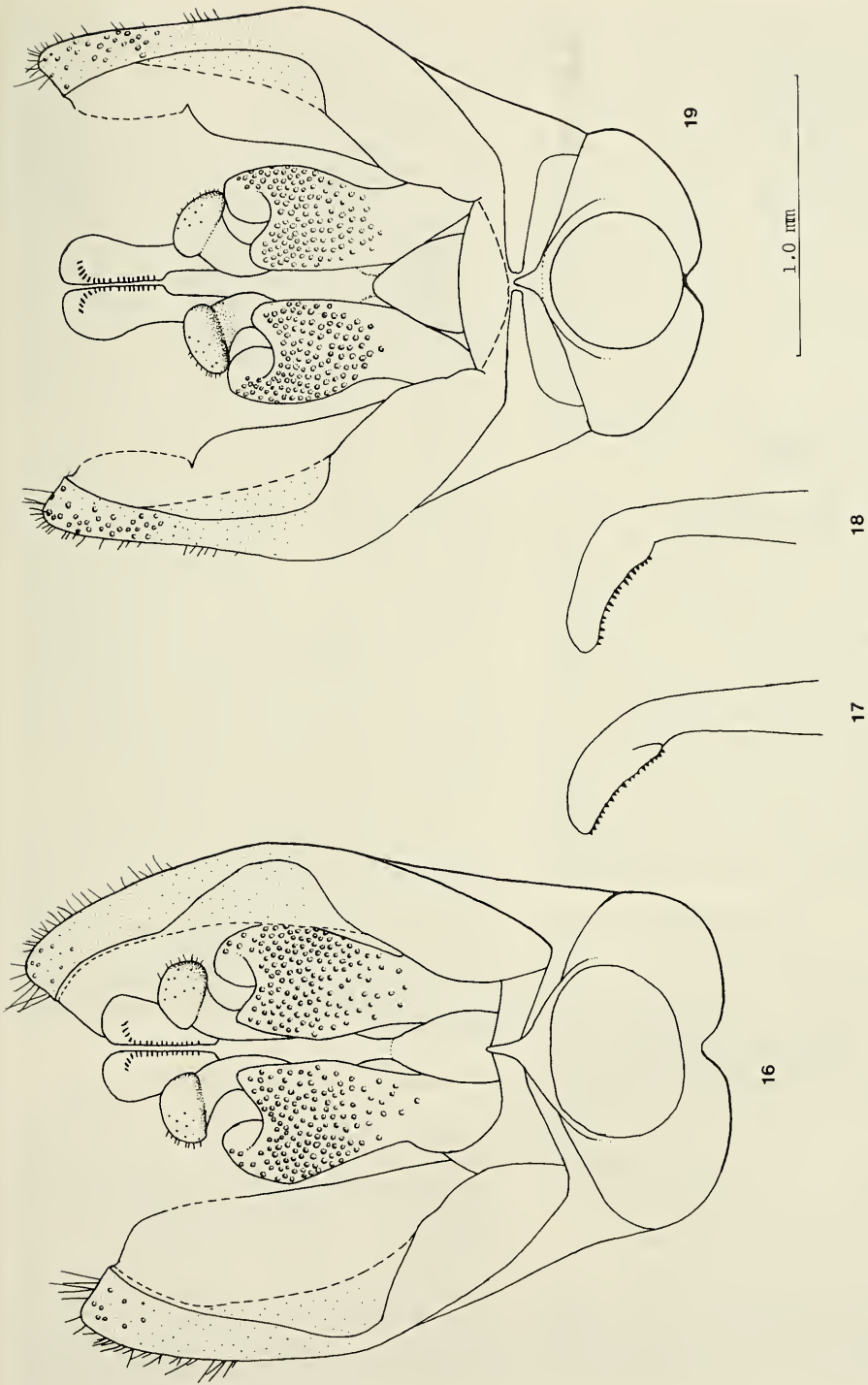

Figs. 16—19. 16—17. *Sceliphron funestum* Kohl, ♂, Greece. 16, genitalia, ventral aspect; 17, inner side of left half of aedeagus. 18—19, *Sceliphron rectum* Kohl, ♂, India, Gujarat. 18, inner side of left half of aedeagus; 19, genitalia, ventral aspect.

and mesosoma white, tomentum of face silvery.

Morphology: Female. — Clypeus without well-differentiated lobes (fig. 4); post-antennal tubercles distinct (fig. 5); hypostomal carina runs to base of mandibles, like in *Sceliphron* s.s.; pronotum with median impression; mesoscutum sharply transversely striate, without punctation, finely granulate between the striae; metapleuron finely granulate; scutellum smooth on anterior two-thirds; propodeal orifice rounded, with very narrow dorsal margin (fig. 6); petiolus short, moderately curved, first tergite not swollen (fig. 7); IFR 1.16—1.18; PTR 0.62—0.69; PR 0.08—0.09; TR 0.20—0.24; SR 0.90—1.09. Male. — Like the female, but clypeus laterally emarginate, and with the apical lobes more or less fused (fig. 8); petiolus longer. IFR unknown; PTR 0.79; PR 0.091; TR 0.16; SR 0.86.

Coloration: Black; the following parts are bright yellow: rectangular spot on clypeus, scape ventrally, bands on pronotum and scutellum, spots on tegula, on mesopleuron below tegula, near basis of propodeum and near apex of dorsal enclosure, a large mark near apex of propodeum; legs yellow, except coxae, trochanters, basal half of femora and basal half of posterior tibiae, apical tarsomeres infuscated; petiolus yellow, basal half ventrally and laterally black, apical half with lateral black lines; first tergite yellow with antero-median dark patch, following tergites with broad yellow bands, sternites with lateral spots, those on fifth and sixth sternite almost coalescent; wings yellowish hyaline.

Distribution. — Southern USSR: Tadjikistan, Kirgizia, Turkmenistan (fig. 114)

Material examined. — Tadjik SSR. — 1 ♀, Kondara (35 km N. Dushanbe), 8 July 1979, W. J. Pulawski (USNM); 1 ♀, Kondara, Varzoba, 1100 m, July 1937, Gussakovskij (USNM); 1 ♀, Aman Kuta, 6 July 1932, V. Gussakovskij (ZIL).

Kirgiz SSR. — 1 ♀, Tashkent, 17 June 1930, G. Kuzan (ZIL).

#### *Sceliphron funestum* Kohl (figs. 9—11, 16, 17, 114)

*Sceliphron funestum* Kohl, 1918: 121, ♀ — Izmir, Turkey (NMW; not examined).

*Sceliphron* (*Prosceliphron*) *funestum*; Bohart & Menke, 1976: 106.

Description. — Body length: ♀ 17.6—21.1 mm, ♂ 18.7 mm; length of forewing: ♀ 11.2—12.9 mm, ♂ 12.0 mm. Pubescence white, tomentum of face silvery.

Morphology: Female. — Head broad, the eyes distinctly swollen; clypeus without distinctly differentiated lobes (cf. fig. 12); pronotal collar in lateral view longer and lower than in other *Prosceliphron* (fig. 9), dorsally with median impression; mesoscutum strongly transversely striate, scutellum longitudinally striate, striae anteriorly not evanescent; scutellum with shallow median impression; integument of head and mesosoma comparatively dull, strongly granulate; claws of fore legs untoothed; dorsal margin of propodeal orifice narrow and rounded (fig. 11); petiolus nearly straight and about as long as the hind tibia, posteriorly compressed, 1.5 times as high as broad, first tergite short and slender (cf. fig. 15); IFR 0.84—0.86; PTR 0.99—1.06; PR 0.02—0.03; TR 0.15—0.16; SR 0.48—0.50. Male. — Like the female, but clypeus with ventral margin rounded, medially shallowly emarginate (cf. fig. 13); petiolus longer and somewhat curved (fig. 10); genitalia (fig. 16, 17): gonobasis with well-developed tooth, gonostyles with rather inconspicuous lamellae, volsellar plate narrow, oblong, cuspis without long hairs (for differences between *S. funestum* and *S. rectum*, see under the latter). IFR 0.85; PTR 1.0; PR 0.04; SR 0.48.

Coloration: Black; the following parts are yellow: ventral half of scape, spot on tegula, apex of fore and middle femora, apex of fore and middle tibiae (scutellum with transverse spot in a male from Rhodes); fuscous: third flagellomere, anterior sides of fore and middle tibiae (black in specimens from Crete). Wings light greyish hyaline, apex of forewing darkened.

Distribution. — Greece, Turkey (fig. 114).

Material examined. — Turkey. — 1 ♀, Reshadieh, Sept. 1929, Harry Stiner (USNM); 1 ♀, Icel, Silifke-Sapakili, July 1963, 300 ft., E. James (BMNH); 1 ♀, Silifke 35 km NNW, Kargican, 200 m; 4 Aug. 1985, R. Hensen (CH).

Rhodes. — 4 ♀, Ixia, 1—4 Sep. 1962, P. M. F. Verhoeff (RMNH); 1 ♀ 1 ♂, near Lindhos, 21 Aug. 1975, Ph. Pronk (RMNH).

Crete. — 1 ♀, Chanea, 16—20 July 1942, K. Zimmermann (RMNH); 1 ♀, Chania, Samaria,

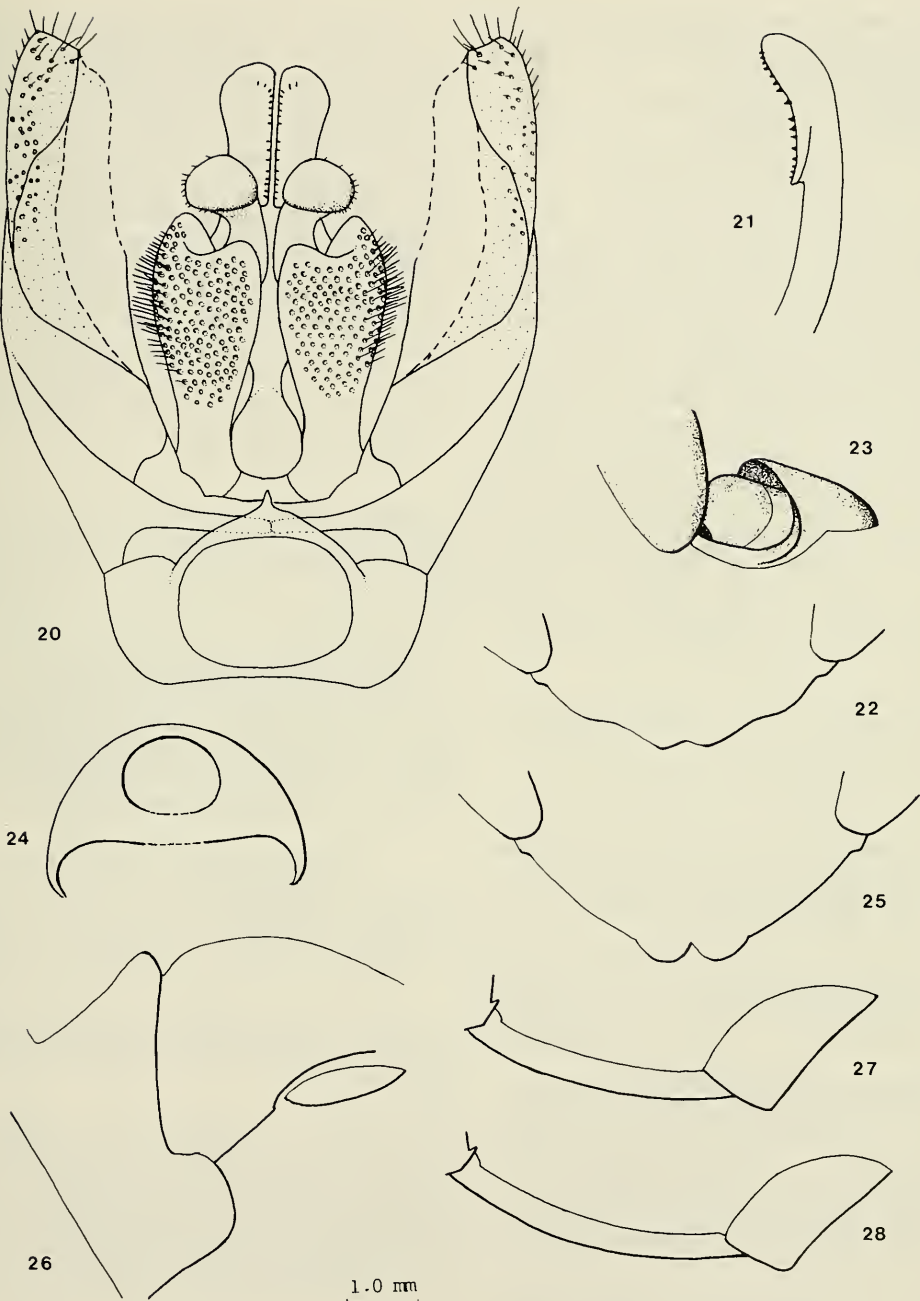

Figs. 20—28. *Sceliphron curvatum* (Smith). 20—22, ♂, Austria. 20, genitalia, ventral aspect; 21, inner side of left half of aedeagus; 22, clypeus. 23—24, ♀, India, Uttar Pradesh. 23, antennal insertion; 24, propodeal orifice. 25, ♀, India, Punjab, clypeus. 26—27, ♀, India. 26, pronotum, lateral aspect; 27, first metasomal segment. 28, ♂, India, Calcutta, first metasomal segment. 22, 25, 27, 28: scale-line; 26: 2.0 × scale-line; 23, 24: 4.0 × scale-line; 20, 21: 8.0 × scale-line.



29 July 1981, P. van Ooyen (coll. van Ooyen); 1 ♂, Messaraebene, Ampelusus, 3 July 1942, K. Zimmermann (RMNH).

Greece. — 1 ♀, Iliia, Olympia, 4—11 July 1979, M. C. Day (BMNH).

**Sceliphron rectum** Kohl  
(figs. 12—15, 18, 19, 114)

Description. — Body length: ♀ 16.5—19.4 mm. ♂ 14.4—17.3 mm; length of forewing ♀ 11.6—12.3 mm, ♂ 9.3—11.4 mm. Pubescence: erect pubescence white, head densely, mesosoma sparsely covered with silvery tomentum.

Morphology: structurally *S. rectum* is practically identical to *S. funestum*; the difference in colour-pattern however is striking, and there are differences in the genitalia of the ♂ (fig. 18, 19): the volsellar plate is triangular, whereas in *S. funestum* it is oblong, and the aedeagus-head is, in lateral view, proximally broader than apically, whereas in *S. funestum* it is parallel-sided. ♀ — IFR 0.84—0.92; PTR 0.94—1.07; PR 0.015—0.02; TR 0.10—0.19; SR 0.48—0.54. ♂ — IFR 0.89—1.00; PTR 1.04—1.13; PR 0.01—0.02; TR 0.07—0.11; SR 0.32—0.42.

Distribution. — Iran, United Arab Emirates, Pakistan, India (fig. 114).

Key to the subspecies of *Sceliphron rectum* Kohl

1. Metanotum with yellow band, propodeum with extensive yellow markings, at least first tergite with yellow band, hind tibiae black; Iran to India ..... *pulchellum* Gussakovskij
- Metanotum, propodeum and first tergite black; hind tibiae yellow on outer side; Sik-kim ..... *rectum* Kohl

**Sceliphron rectum pulchellum** Gussakovskij

*Sceliphron bilineatum*; Dutt, 1912: 221—223, figs. 10, 10a, 11 (W. India and Pusa; bionomics) (misidentification).

*Sceliphron pulchellum* Gussakovskij, 1933: 275, ♂ — Bushir, Iran (ZIL; examined).

*Sceliphron (Prosceliphron) pulchellum*; Bohart & Menke, 1976: 106.

Type. — According to the original description, the species was based on only one specimen, the holotype. It is labelled "Bushire, Persia", "*Sceliphron pulchellum*, sp. n., ♂, V. Gussakovskij", and "k. Gussakovskij".

Description. — Coloration: female (hitherto undescribed). — Black, the following parts yellow: small spot on clypeus, antennal scape and flagellomeres 1—4 ventrally, broad band on pronotum, scutellum and metanotum, spots on tegulae, large subtegular spots, propodeum with basal spots and very large terminal mark, which is confluent with a pair of spots in the dorsal enclosure; legs yellow except basal third of femora and hind tibiae; wings yellowish hyaline, apex of forewing darkened; petiolus and large transverse spot on first tergite yellow. Male. — Like the female, but with additional yellow spots on alle coxae, first tergite nearly entirely yellow, third to seventh tergite with yellow apical bands (in the Indian and Pakistani material the third and fourth tergite are black).

Material examined. — India. — 1 ♀ 2 ♂, Ahmedabad, bred from cell, 16 Aug. 1967, S. D. Jayakar (MNHN, RMNH); 1 ♀, Pachrukhi, Behar, 1927, Cornell U. Lot 753 (Cornell Univ., New York).

Pakistan. — 2 ♀, Kurrachee, Aug.—Sept., Maindron 133—96 (MNHN, RMNH).

United Arab Emirates. — 2 ♀ 13 ♂, Hatta, 23 Oct.—13 Nov. 1981; 1 ♀, Wadi Uyoynah, nr. Dibba, 7 Aug. 1981; 1 ♂, Masafi, 7 Aug. 1981, all C. D. Roche (coll. Roche, duplicates in BMNH, coll. Guichard, USNM, CH).

**Sceliphron rectum rectum** Kohl

*Sceliphron rectum* Kohl, 1918: 124—125, ♀, — Sik-kim, India (ZMB; examined).

*Sceliphron (Prosceliphron) rectum*; Bohart & Menke, 1976: 106.

Type. — The holotype, and only known specimen of the subspecies, is labelled "Sikhim, coll. Bingham".

Description. — Differs only by coloration from the previous subspecies, the pattern was described in full detail by Kohl (1918); characteristic are the bands on the pronotum and scutellum, large subtegular spots, petiolus largely yellow, remainder of metasoma black, and propodeum black.

**Sceliphron curvatum** (Smith)  
(figs. 20—28, 115)

*Pelopoeus curvatus* Smith, 1870: 187, ♂ (not ♀!) —

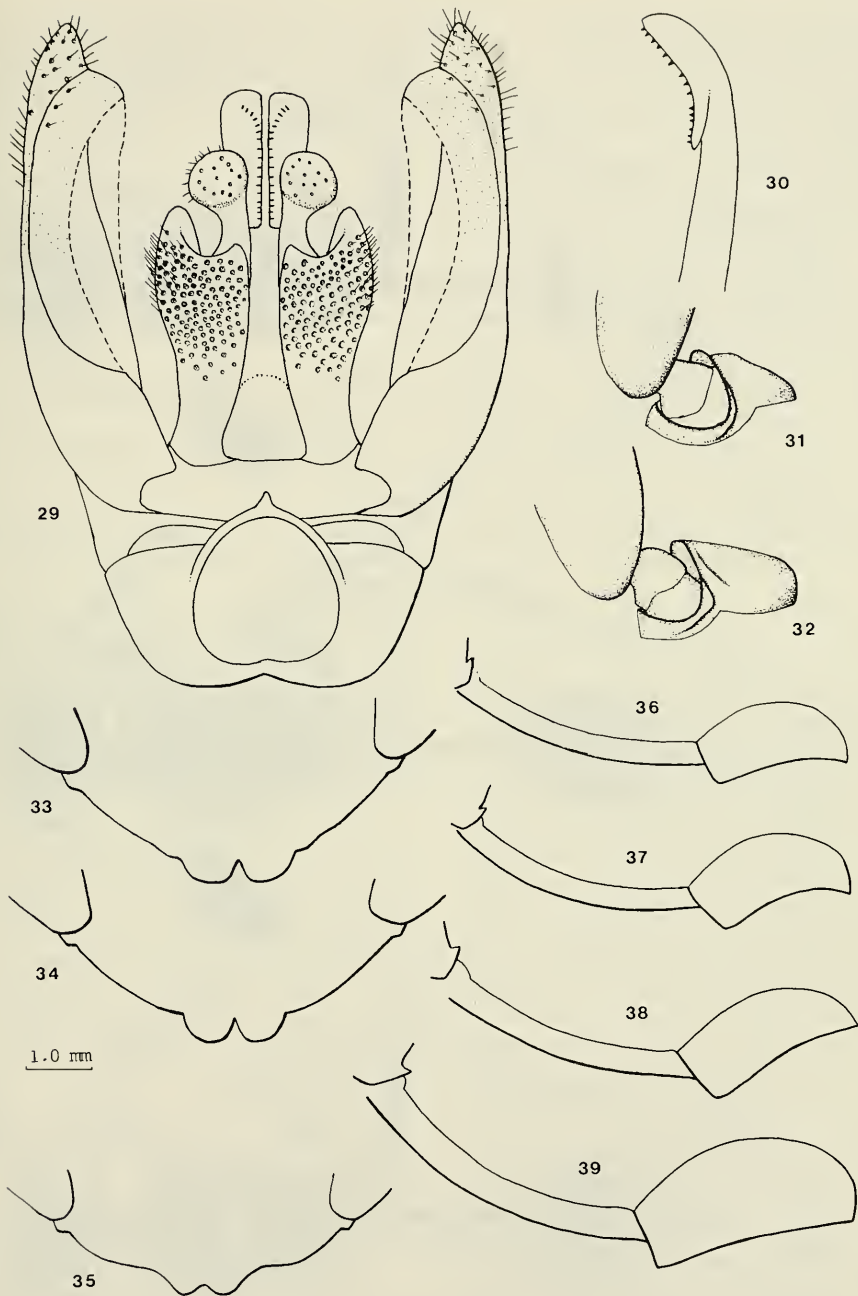

Figs. 29—39. *Sceliphron deformis* (Smith). 29—30, ♂, Japan. 29, genitalia, ventral aspect; 30, inner side of left half of aedeagus. 31, ♀, *S. d. deformis* (Smith), China, Tibet, antennal insertion. 32, ♀, *S. d. atripes* (Morawitz), USSR, Primori area, antennal insertion. 33—35, clypeus; 33, ♀, Thailand; 34, ♀, India, Khasia; 35, ♂, Japan. 36—39, first metasomal segment; 36, ♂, India, Darjeeling; 37, ♂, China, Tibet; 38, ♀, holotype *S. d. femorale* ssp. n.; 39, ♀, Taiwan. 33—39: scale-line; 31, 32: 4.0 × scale-line; 29, 30: 8.0 × scale-line.

Mainpuri, India (BMNH; examined).

*Sceliphron curvatum*; Strand, 1915: 91 (Naga Hills).

*Sceliphron deforme*; Kohl, 1918: 122; Basil-Edwards, 1921: 293—297, figs. 1, 2 (bionomics at Simla, India); Beaumont, 1969: 390 (Afghanistan: Kabul).

*Sceliphron (Prosceliphron) curvatum*; Bohart & Menke, 1976: 106; Van der Vecht, 1984: 213—219, figs. 1—5 (descriptions ♀, ♂; established in the Steiermark, Austria).

Type. — The BM possesses a male with labels “*Pelopoecus curvatus* (type) Smith” in Smith’s handwriting, and “69—86”, which means, according to the BM register: “Presented by Ch. Horne, these are the type spec. descr. in the VII vol. Tr. Zool. Soc.”. The description speaks only of female, apparently more than one, since a range of lengths is given. The specimen mentioned is probably one of the types, and somehow a mistake was made in the description. I designate it herewith as the lectotype.

Description. — Body length: ♀ 15.6—18.0 mm, ♂ 16.0—17.3 mm; length of forewing: ♀ 10.8—12.1 mm, ♂ 10.3—10.8 mm. Pubescence: yellowish-white, tomentum of face pale-golden.

Morphology: Female. — Clypeus with only feebly differentiated lobes (fig. 25); post-antennal tubercles moderately large (fig. 23); interocular distance at vertex larger than first flagellomere; pronotum with median impression, in lateral view narrow (fig. 26); mesoscutum irregularly transversely strigose, with dense shallow punctation over the whole surface, comparatively dull; other parts of integument of head and mesosoma also more distinctly punctate and less shiny than in other *Prosceliphron*; dorsal margin of propodeal orifice narrow and rounded (fig. 24); claws of fore legs untoothed; petiolus short, curved, first tergite swollen, but not as strongly as in *S. deforme* and *S. fervens* (fig. 27). IFR 1.10—1.21; PTR 0.75—0.77; PR 0.06—0.07; TR 0.18—0.26; SR 0.84—0.88. Male. — Like the female but apical margin of clypeus laterally shallowly emarginate (fig. 22), as in *S. deforme*; petiolus longer (fig. 28); genitalia (fig. 20, 21) similar to those of *S. fervens* and *S. deforme*, but cuspis with comparatively more and denser pubescence, volsellar plate of slightly different shape, gonostyles not pointed apically, and with better differentiated lamellae than in *S. fervens*. IFR 1.13—1.21; PTR 0.86—1.00; PR 0.08—0.11; TR 0.16—0.20; SR 0.72—0.76.

Coloration: As described by Van der Vecht (1984) in full detail. Diagnostic features are the

presence of reddish-yellow bands on all tergites and sternites, and the laterally abbreviated clypeal mark. Spots at the basis of the propodeum are only present in specimens from Tadzhikistan and Pakistan.

Distribution. — Originally the species seemed to be confined to mountainous regions South and West of the Himalayas, in Tadzhikistan, Pakistan, India and Nepal (fig. 119). The record of *S. deforme* from Afghanistan (Beaumont, 1968) probably pertains to *S. curvatum*.

Material examined. — Kazakhstan. — 2 ♀, N. Tashkent, Gr. Tchimgan, 2500 m, 12 July 1984, J. Oehlke (DEI).

Tadzhikistan. — 1 ♀, Kalai-Vamar, Roshan (37°50'N, 72°30'E), 30 June 1937, Lupkova (ZIL).

Pakistan. — 1 ♀, Hazara, Kawai, Shogran, 2300 m, 14—17 May 1978, C. Holzschuh (Coll. Gusenleitner).

Nepal. — 1 ♀, Kathmandu, 1300—1400 m, May 1966, J. & M. Sedlacek (BPBM); 1 ♀, 5 mls. W. of Pokhara, 3000 ft., 13 May 1954, J. Quinlan (BMNH); 3 ♀, Taplejung Dist., Sango, 6200 ft., Sep.—Oct. 1961, R. L. Coe (BMNH); 1 ♀, Kathmandu, 1500 m, June 1982, 6 ♀, Kakani, 2070 m, June 1984, all M. G. Allen (BMNH).

India. — 1 ♀, Nat. Highway 110 km N. Jammu, 6 July 1978, J. Timmer (ZMA); 1 ♀, Punjab, 1886, Harmand 411—87 (MNHN); 5 ♀, Mussoorie, 23 May 1905, E. Saunders coll. (BMNH); 8 ♀, Simla, May 1897, Nurse (BMNH); 1 ♀, Mussoorie (NMW); 1 ♀ Himalaya, Felder (RMNH); 1 ♀, Simla, 26 Nov. 1918, Brunetti (BMNH); 1 ♀, Kumaon, April 1890, coll. Bingham (BMNH); 1 ♀, W. India, Bacon (OUM); 1 ♀, Xymcan, S. P. Yzau, 12 June 1970 (?) USNM).

Austria. — 2 ♀ 4 ♂, Steiermark, Demmerkogel/Sausal, 12 July 1983, J. & E. van der Vecht (RMNH, USNM).

### *Sceliphron deforme* (Smith) (figs. 1, 29—48, 116)

Description. — Body length: ♀ 16.2—20.7 mm, ♂ 14.4—16.5 mm; length of forewing: ♀ 10.4—13.3 mm, ♂ 10.3—12.1 mm. Pubescence: erect pubescence of head and mesosoma white or slightly yellowish, tomentum of face usually pale-golden. Wings hyaline, apex of forewing darkened, but dark area not sharply defined.

Morphology: Female. — Clypeus without



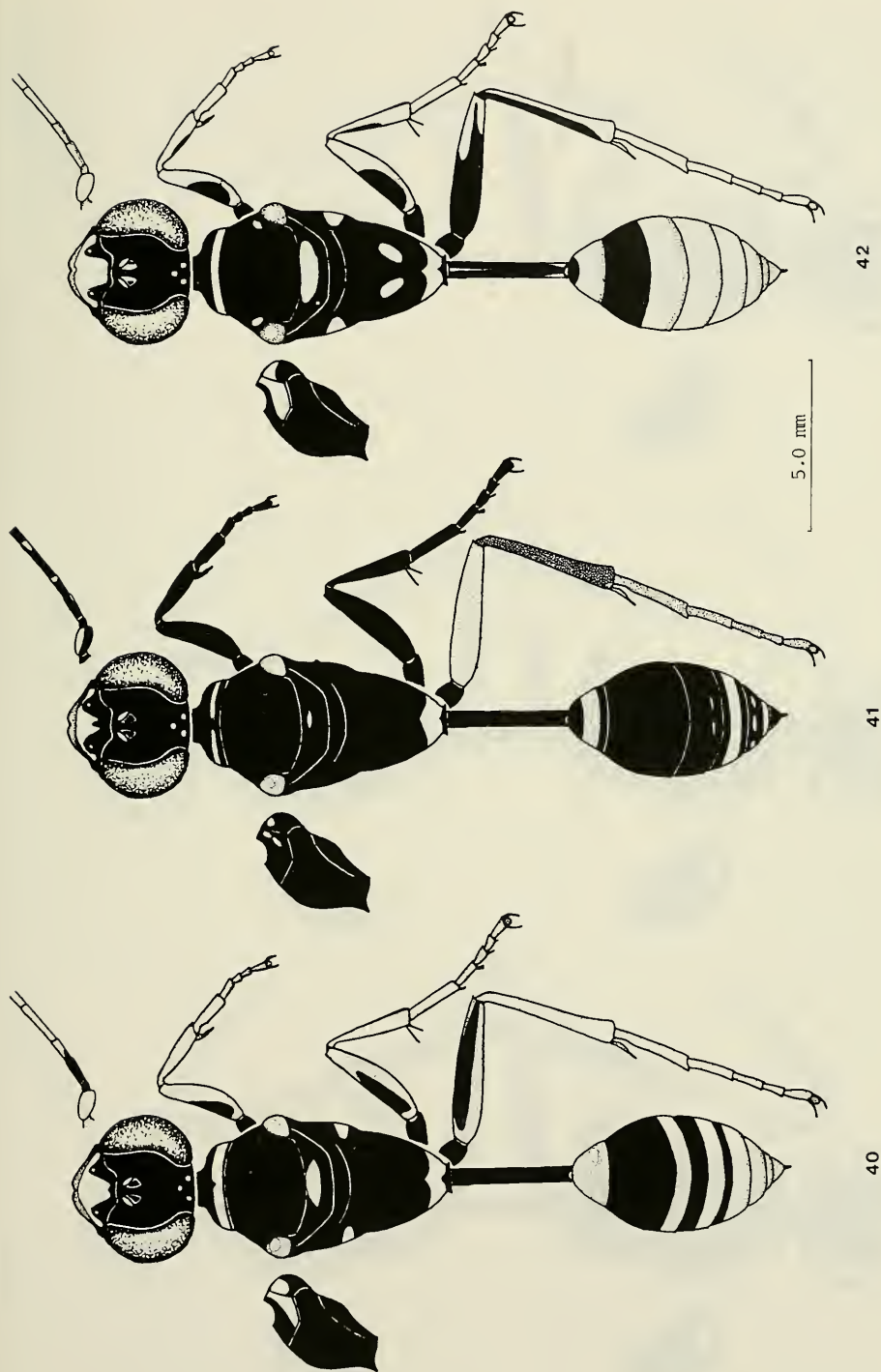

Figs. 40—42. *Sceliphron deforme* (Smith), colour patterns. 40, *S. d. tibiale* Cameron, ♀, India, Khasia; 41, *S. d. femorale* ssp. n., ♀, holotype; 42, *S. d. deforme* (Smith), ♀, China, Tibet.

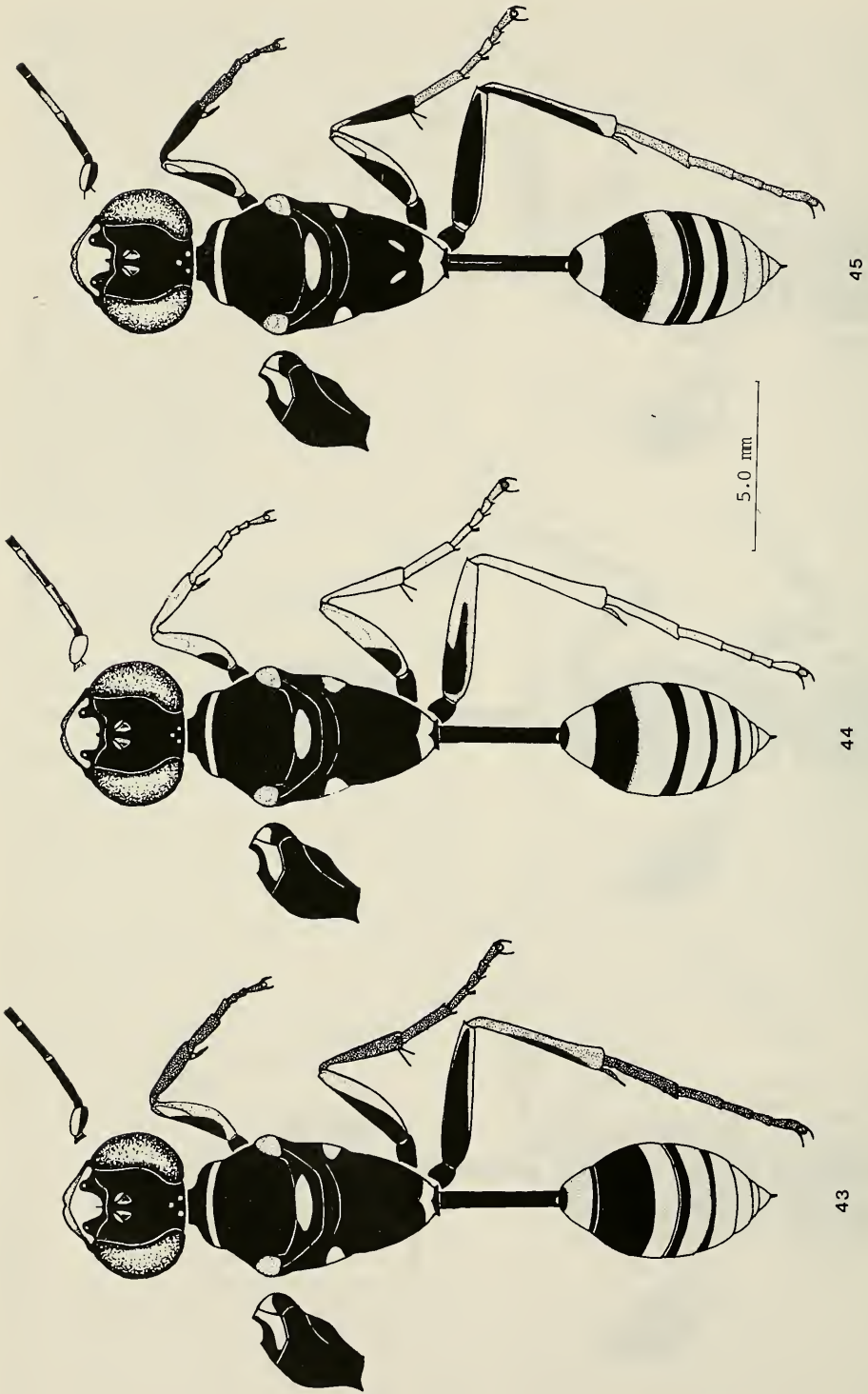

Figs. 43—45. *Sceliphron d. deforme* (Smith), colour patterns. 43, ♀, China, Szechwan, Suifu; 44, ♀, Taiwan; 45, ♀, China, Kiangsu.

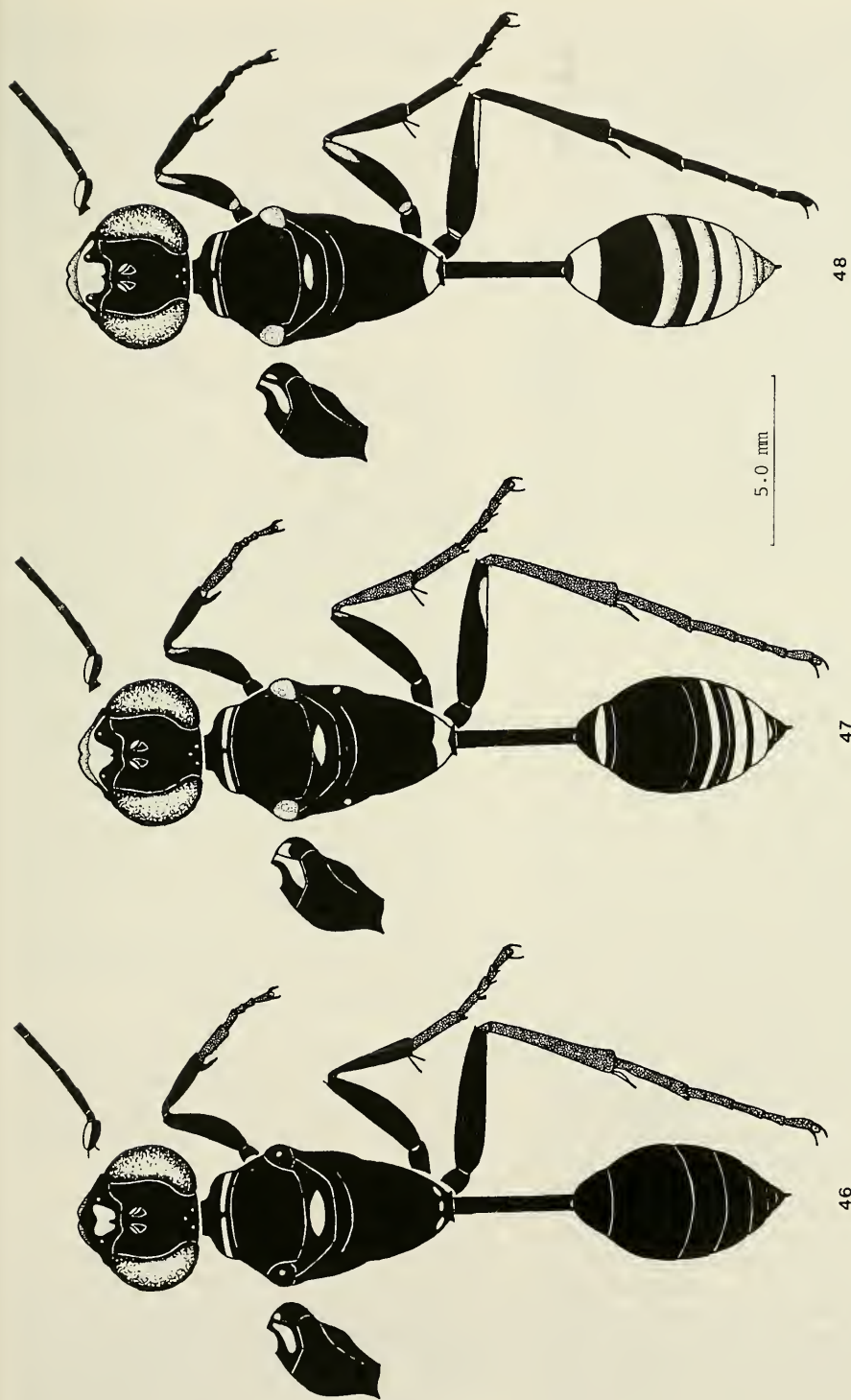

Figs. 46—48. *Sceliphron deforme* (Smith), colour patterns. 46—47, *S. d. atripes* Morawitz; 46, ♀, lectotype; 47, ♀, USSR, Vladivostok; 48, *S. d. nipponicum* Tsuneki, ♀, Japan, Honshu.



lateral incisions (fig. 33, 34); interocular distance at vertex rather large, but not as large as in *S. curvatum*; post-antennal tubercles variable in size; pronotum with median impression; mesoscutum sharply transversely striate, laterally and anteromedially with more or less distinct punctation between the striae; propodeal orifice with narrow, rounded dorsal margin (cf. fig. 24); petiolus short, shorter than hind tibia, and strongly curved, first tergite long and strongly swollen (figs. 28, 39). IFR 0.93—1.10; PTR 0.82—0.97; PR 0.09—0.12; TR 0.22—0.36; SR 0.70—1.00. Male. — Like the female, but clypeus with small triangular lobes, laterally of which the margin is distinctly emarginate (fig. 35); petiolus longer, first tergite shorter and more strongly swollen (figs. 36, 37); genitalia (figs. 29, 30) with comparatively slender aedeagus and volsella, volsellar plate oblong, hardly differentiated, pubescence of cuspis comparatively short. IFR 1.00—1.23; PTR 0.86—1.10; PR 0.10—0.14; TR 0.28—0.38; SR 0.67—0.92.

Distribution. — Continental Asia from Kazakhstan to Thailand and the Ussuri-area; Taiwan, Japan (fig. 116).

The species shows a considerable amount of variation over this area, mainly with respect to colour-pattern, but also in the shape and size of the post-antennal tubercles. This last character appears to vary clinally, the Northern forms having large, conspicuous tubercles, whereas in Southern specimens these structures are hardly developed. I have tried to express the variation by distinguishing a number of subspecies, for most of which names are already available. I am well aware of the fact that in some cases the limits between these are purely artificial. This is due to the fact that where several characters can be used to define continental subspecies, these characters may show zones of intergradation which are geographically separated. A clear example is presented in the subspecies *d. deforme* and *d. atripes*: *S. d. atripes* typically has large post-antennal tubercles, and a strongly reduced colour-pattern, but specimens from Korea and Northern China combine large tubercles with the bright colour-pattern of *d. deforme*, which typically has rather small tubercles. Thus this population, as a whole is intermediate between two other subspecies, and cannot be considered a separate third subspecies, but neither can it be placed unequivocally under one of the two. In other cases however, the limits between the subspecies may be fairly sharp, for example be-

tween *deforme* and *tibiale*, which are separated by the natural barrier of the Himalayas.

The following key may serve to distinguish between the subspecies. It is based on females, since the range of variation in males does not allow the construction of an adequate key. However, in general the males show the same geographic variation in characters.

Key to the subspecies of *Sceliphron deforme* (Smith)

1. Antennal scapes dorsally black . . . . . 2
- Antennal scapes completely yellow or reddish dorsally . . . . . 5
2. Hind femora nearly entirely reddish, in contrast to the fore and middle, which are nearly entirely black; post-antennal tubercles small, black (fig. 31); Thailand, Laos . . . . . *femorale* ssp. n.
- Hind femora largely black, like the fore and middle; post-antennal tubercles variable . . . . . 3
3. Post-antennal tubercles very large, dorsally truncate (fig. 32); Southern Siberia, Mongolia to Korea . . . . . *atripes* (Morawitz)
- Post-antennal tubercles small (fig. 31) . . . . . 4
4. Yellow colour-pattern reduced: flagellum entirely black, basal propodeal spots absent, hind tibiae black (fig. 48); Japan . . . . . *nipponicum* Tsuneki
- Yellow colour-pattern more extensive: second flagellomere anteriorly reddish, basal propodeal spots present, hind tibiae partly reddish (figs. 43, 45); China . . . . . *deforme* (Smith)
5. Yellow bands on first and second tergite complete; post-antennal tubercles with yellow spot (figs. 42, 44); China . . . . . *deforme* (Smith)
- Bands on first and second tergite reduced, largely suffused with red; post-antennal tubercles black (fig. 40); Northern India, Burma . . . . . *tibiale* Cameron

*Sceliphron deforme tibiale* Cameron (figs. 40, 116)

- Sceliphron formosum*; Bingham, 1897: 236, 239, ♀ ♂.  
*Sceliphron tibiale* Cameron, 1899: 53 (sex not mentioned) — Khasia Hills (OUM; examined).  
*Sceliphron lineatipes* Cameron, 1900: 36, ♀ ♂ — Khasia Hills, coll. Rothney (OUM; examined).  
*Sceliphron deforme*; Strand, 1914: 116 (nest); Kohl, 1918: 122 (Bombay, Darjeeling, Burma: Moulmain, Tenasserim).

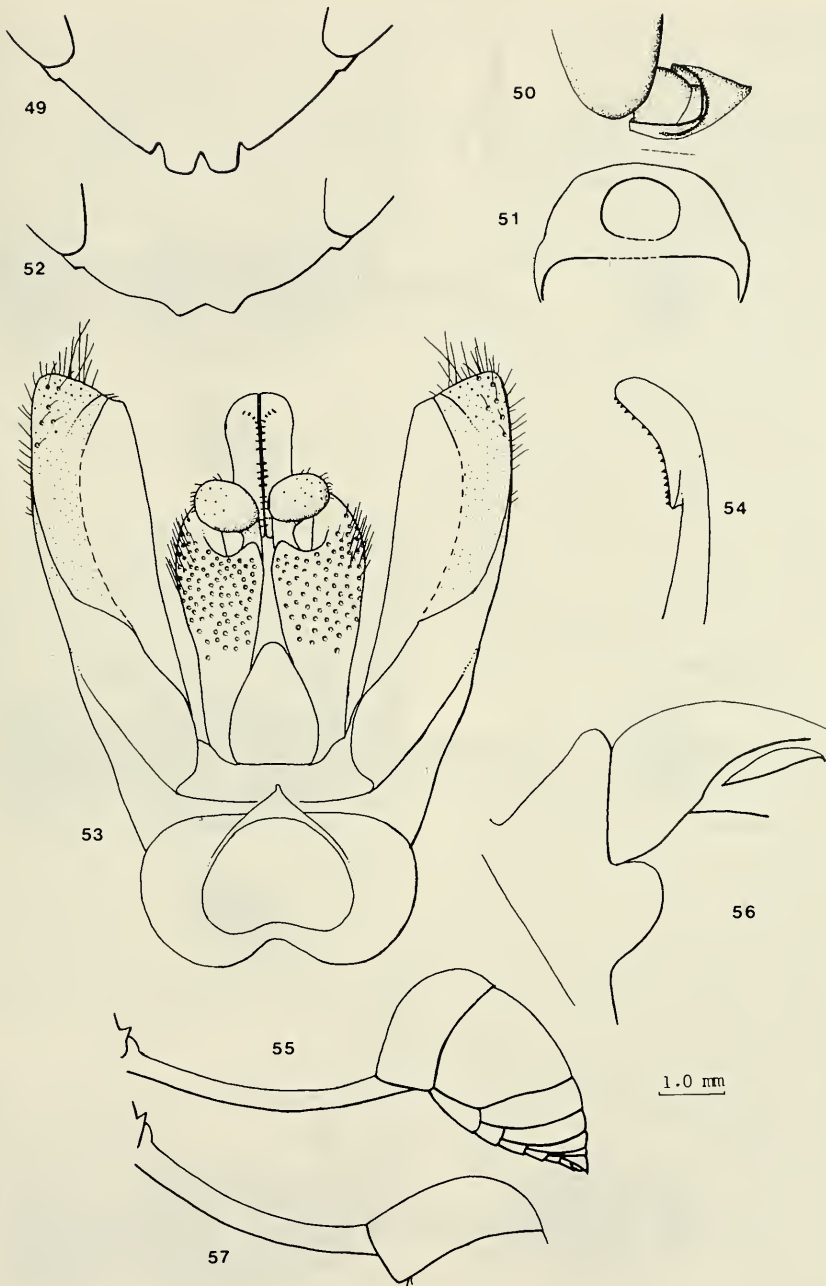

Figs. 49—57. *Sceliphron fervens* (Smith). 49—50, ♀, Indonesia, Borneo, 49, clypeus; 50, antennal insertion. 51, ♀, Malaysia, propodeal orifice. 52—55, ♂, Malaysia, 52, clypeus; 53, genitalia, ventral aspect; 54, inner side of left half of aedeagus; 55, metasoma, lateral aspect. 56, ♀, Malaysia, pronotum, lateral aspect. 57, ♀, Indonesia, Borneo, first metasomal segment. 49, 52, 55, 57: scale-line; 56: 2.0 × scale-line; 50—51: 4.0 × scale-line; 53, 54: 8.0 × scale-line.

*Sceliphron (Prosceliphron) deforme tibiale*; Bohart & Menke, 1976: 106.

Types. — The OUM possesses one female specimen labelled "*Sceliphron tibiale* Cameron, type, Khasia", which I herewith designate as the lectotype. In the BMNH I have seen two females labelled "*S. tibiale* Cameron, Khasia", "ex FMS 1955—354", which I have labelled as paralectotypes, since *S. tibiale* was described from material in the FMS-collection.

*S. lineatipes* was described from OUM-material. I found there two male specimens on one pin, with label "*Sceliphron lineatipes*, type, Cameron". The upper specimen fits the rather incoherent description best: it agrees at least with the Latin diagnosis. I herewith designate it as the lectotype. The lower specimen is paralectotype, as is a male labelled "*Sceliphron lineatipes* Cam., type, Khasia" in the BMNH. Several of 72 partly unlabelled specimens in the OUM and ZMA may have been part of the original type-material too, since *S. tibiale* was described from both sexes, but there is no evidence based on label data which allows designation of more paralectotypes.

Description. — Post-antennal tubercles small (cf. fig. 50), black. Yellow colour-pattern rather extensive (fig. 40). Characteristic are: antennal scape yellow or reddish yellow; propodeum often with a pair of spots at apex of the dorsal enclosure; legs reddish except the coxae, trochanters and base of femora dorsally; metasoma with broad yellow bands on all tergites, those on first and second tergite suffused with red or reduced; sternites with lateral reddish-yellow spots.

In the male the coloration is like the female or more or less reduced: clypeus with a pair of small spots or completely black, scapes dorsally black, spots at basis of propodeum small or absent; legs brownish, hind femora ventrally somewhat lighter; metasoma with narrow bands on fourth to sixth tergite, those on second and third reduced or absent.

Variation. — Specimens from Darjeeling tend to be more brightly coloured than described above: in the male the clypeus bears a large mark, the scapes are red dorsally, the legs are mainly red-yellow and the metasoma has complete bands on all tergites.

Material examined. — India. — 1 ♀, Dacca, 30 May 1945, D. Leston (BMNH); 2 ♀, N. Khasia Hills (BMNH); 5 ♀ 5 ♂, Khasia, coll.

Bingham (OUM); 4 ♀, Sikkim, Runjit Valley, 1000 ft., April 1894, Bingham coll. (BMNH); 3 ♀, Sikkim, F. A. Müller (UZM); 1 ♀, N.W. India (BMNH); 1 ♀, N. India, Lukna, 55 km S. Darjeeling, May 1966, Sedlacek (BPBM); 3 ♀, Sikkim, coll. Bingham (BMNH); 2 ♀ 1 ♂, Darjeeling, coll. Frühstorfer (RMNH); 19 ♀ 10 ♂, Khasia Cameron (ZMA); 10 ♀, Sikkim, coll. Bingham (ZMB).

Burma. — 1 ♀, Rangoon Dist., March 1888, Bingham coll. (BMNH); 1 ♀, Pegu Hills, March 1889 (BMNH).

### *Sceliphron deforme femorale* ssp. n.

(figs. 38, 41, 116)

Holotype. — ♀, Thailand, Chiangmai, 4 May 1952, D. & E. Thurman (USNM).

Description. — Post-antennal tubercles small, black (like in *S. d. tibiale*); colour-pattern much less extensive than in adjacent subspecies (fig. 41); antennal scape yellow ventrally; pronotum with narrow, interrupted yellow band; subtegular spots small; scutellum with narrow transverse spot; propodeum only with small apical spot; fore and middle femora black, with small yellow spot apically; hind femora reddish; legs otherwise blackish; metasoma black, first tergite medially reddish-yellow, third with strongly reduced, fourth with complete yellow apical band; fifth and sixth reddish-yellow; tomentum of face golden, erect pubescence purely white.

Structurally *S. d. femorale* is identical with *S. d. tibiale*. With respect to colour-pattern however, the form resembles the related species *S. fervens*, which occurs in the adjoining area; this particular colour-pattern may thus represent an independently developed environmental adaptation.

Paratypes. — Thailand. — 1 ♀, Doi Suthep, 4—10 May 1952, D. & E. Thurman (USNM); 2 ♀, Khun Tan Mts., May 1933, 4000 ft., H. Smith coll. (USNM, RMNH) (with basal spots on propodeum, larger scutellar band, one with complete band on third tergite).

Laos. — 2 ♀, Pak Kop, Mekong River, 7 May 1920, R. V. de Salvaza (BMNH) (one of these with propodeal spots basally).

### *Sceliphron deforme deforme* (Smith)

(figs. 31, 43—45)

*Pelopoëus deformis* Smith, 1856: 231, ♀ — North China, coll. Fortune (BMNH; examined).

*Sceliphron deforme*; Strand, 1914: 116 (Tsingtau,



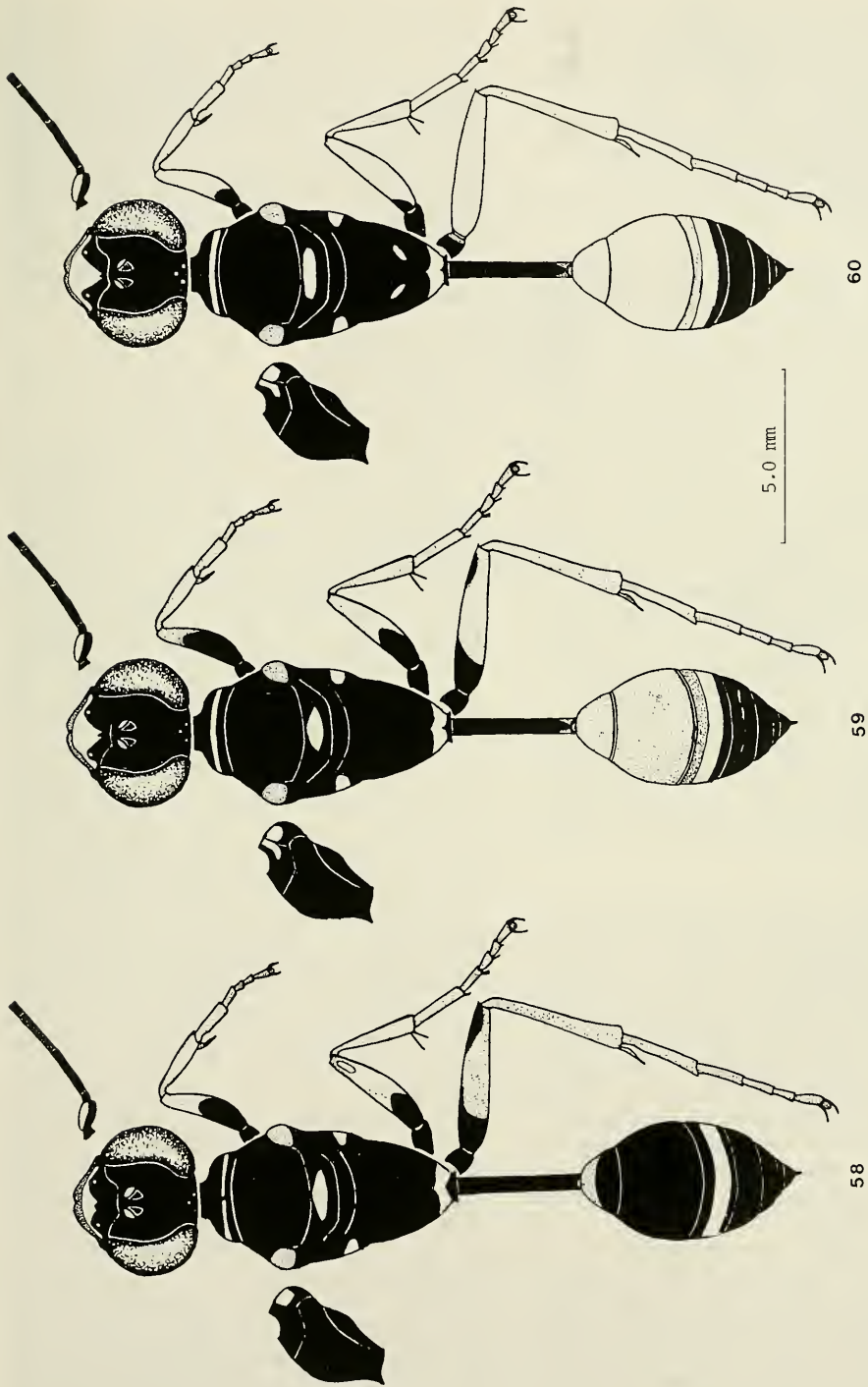

Figs. 58—60. *Sceliphron fervens* (Smith), colour patterns. 58, West Malaysia; 59, ♀, Malaysia, Sarawak; 60, ♀, Philippines, Palawan.

nest); Turner, 1917: 176; Kohl, 1918: 122—123, figs. 26, 27; Gussakovskij, 1936: 4 (N. E. Szechwan); Iwata, 1939: 169, fig. 21 (Formosa, bionomics); Yasumatsu, 1942: 106 (Peking); Tsuneki, 1967 (Formosa).

*Sceliphron deforme taiwanum* Tsuneki, 1971: 6, ♀ ♂ — Taiwan, Taitung pref., Chulu (coll. Tsuneki; not examined); Bohart & Menke, 1976: 106.

*Sceliphron (Prosceliphron deforme deforme)*; Bohart & Menke, 1976: 106.

Type. — The specimen which was figuring as the type of *S. deforme* in the BM (no. 21.613) belongs to *S. curvatum*. It was evidently incorrectly labelled, since it does not agree with the description of *S. deforme*, which mentions a "spot at each side of the metathorax at base"; such spots fail in *S. curvatum*, and moreover, *S. curvatum* does not occur in Northern China. The lectotype by present designation is a female in the BMNH with label "N. China, 54—8" (according to the register: "China, Shanghai, purchased from Stevens, coll. by Fortune"). There is one other specimen which is old enough, and may have been a syntype. It is labelled "56—45, China" ("April; China, purch. from Stevens, coll. by Mr. Bowring") and "type *rufopictus* Smith" in Smith's handwriting.

There are two female specimens in the Saunders' collection (OUM) standing as syntypes of *S. deforme*. One of these belongs to *S. deforme*, the other to *S. curvatum*. There is no evidence that these were part of the original type-material.

Description. — Female. — Post-antennal tubercles of intermediate size (fig. 31), larger than in *S. d. tibiale*, smaller than in *S. d. atripes*, usually with yellow spot; colour-pattern rather extensive (figs. 42—44), only slightly darker than *tibiale*: scapes often black dorsally, tegulae with yellow mark, propodeum with large basal spots, and sometimes with a pair of spots at apex of the dorsal enclosure, legs blackish to red-brown, femora largely black dorsally, ventrally lighter, metasoma with broad reddish-yellow bands on alle tergites, sternites 2—5 with bands or lateral spots.

Male. — Darker than the female, but very variable: clypeus often only with a pair of small spots, basal propodeal spots reduced or absent, bands on tergites usually reduced, sometimes nearly absent.

Variation. — Female specimens from Tibet are very brightly coloured (fig. 42): the scapes are completely yellow, post-antennal tubercles

with yellow mark, often small spots on sides of pronotum, and marks on the mesoscutum in front of the tegula, propodeum with a pair of spots in the dorsal enclosure, legs mainly yellow, femora dorsally black on proximal half, petiolus largely or partly yellow. The coloration of the Taiwanese population was described by Tsuneki (1971), and is illustrated in fig. 44. The pattern is somewhat less bright than that of the Tibetan specimens, and brighter than that of the other mainland populations (fig. 45). I prefer therefore to regard Tsuneki's *S. deforme taiwanum* as part of the nominate species.

Material examined. — Mongolia. — 1 ♂, Tchi-Li, J. de Joannis, 1890 (MNHN); 1 ♀, Tcheli, J. de Joannis, 1903 (MNHN).

China. — 1 ♀, Ningpo, Aug. 1949 (NMB); 1 ♀, China (OUM); 2 ♀, Tientsin, N. China; 1 ♀, Peking, "*curvatum*, det. Kohl", "*deforme*, det. Kohl"; 1 ♀, Tientsin, Walte; 1 ♀, Tsingtau, Prof. Hoffmann; 1 ♀, Tschili; 1 ♂, Tientsin (all NMW); 3 ♂ 1 ♂, Shankhov, Honan, D. Renard (IRSN); 4 ♀ 2 ♂, Kiangsi, A. David, 1875; 1 ♀, Kiangsu, Shanghai, 27 July 1925, 1 ♂, Shanghai, 14 Aug. 1924, both O. Piel; 1 ♂, Kouytcheou, 1921, Cavalérie; 1 ♀ 1 ♂, Shensi, 1875, A. David (all MNHN); Canton, 1 ♀, 8 June 1917, 2 ♂ 1 ♀, 10 May 1917; Lungtaoshan, Kwangtung, 1 ♀, 17 Sep. 1917, 1 ♀, 10 Sep., 1 ♀, 10 June 1917; Lofaoshan, Kwangtung, 1 ♀, 20 July 1916, 1 ♂, 11 Aug. 1916, 1 ♀ 1 ♂, 20 May 1917, 1 ♂, 1 May 1917; Gaotung, Kwangtung, 1 ♂, 3 June, 1 ♂, 9 June; Tshayunshan, Kwangtung, 1 ♀, 11 Aug. 1912, 1 ♀, 24 June 1912, 1 ♀, 13 June 1912; 1 ♀, Sholyunshan, 30 May; all leg. Mell (ZMB); 1 ♀, Chinkiang, 10 June 1924, 1 ♀, Mokanshan, 18 July 1924, both J. F. Illingworth (BMNH); 1 ♀, Hongkong, F. W. Ferry, 1 ♀, Tonkin, Hoabink, Aug. 1918, R. V. de Salvage; 2 ♀, Howlik, R. C. L. Perkins coll.; 1 ♀, Peiping, C. F. Wu coll.; 1 ♀, Foochow, June 1936, M. S. Yang; 1 ♀, Yunnan, 1918, G. Forrest; 1 ♀, Shanghai, 1 ♀, Sinling, pr. Shen-Se, W. A. Maw; 1 ♂, Shihchiachwang, C. F. Wu coll. (all BMNH); 5 ♀, Kiangsu, Kolthoff (NRS); 1 ♀, Kina, N.O. Szechwan, Sven Hedins Exp. C. Asien, Dr. Hummel (NRS); 1 ♀, Foochow, Kellogg (MCZ); 1 ♀, Huaying Shan, Szechwan, Aug. 1932, G. Liu (MCZ); China-Tibet border, 3 ♀, Ludingshiao, 4900 ft., 12—20 Aug. 1930, 1 ♀, Bet. Uenchuan and Mowchow, 4500—5500 ft., 3—6 Aug. 1924, 1 ♀, Dashianglin Pass, 4960 ft., 23 Aug. 1930; Suifu, 1 ♂ 4 ♀, 1928, 1 ♀, May-June 1929, 1000—

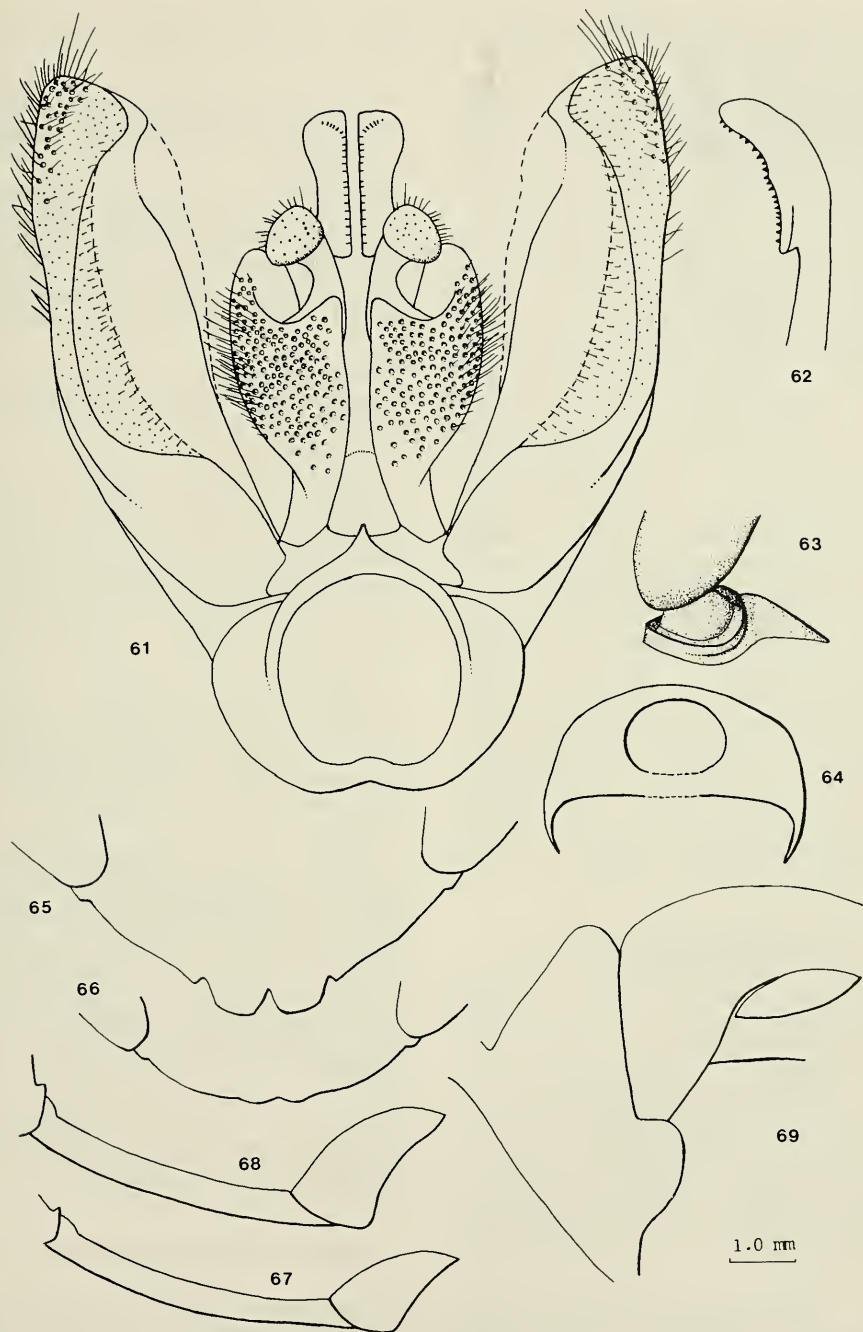

Figs. 61—69. *Sceliphron coromandelicum* (Lepelletier). 61—62, ♂, Malaysia. 61, genitalia, ventral aspect; 62, inner side of left half of aedeagus. 63—65, ♀, India, Kerala. 63, antennal insertion; 64, propodeal orifice; 65, clypeus. 66—67, ♂, Malaysia. 66, clypeus; 67, first metasomal segment. 68—69, ♀, Malaysia. 68, first metasomal segment; 69, pronotum, lateral aspect. 65—68: scale-line; 69: 2.0 × scale-line; 63, 64: 4.0 × scale-line; 61, 62: 8.0 × scale-line.



2000 ft.; 5 ♀, Shinkaisi, Mt. Omei, 4000—5000 ft.; 2 ♀, Yao-Gi, 4800 ft., 3 July 1929; 1 ♀, Chiacopin, 22 Jan. 1933, 2100 ft., 1 ♀, Donomenwai, 10 mi. W. Weichow, 5600 ft., 1933; 1 ♀, S. of Suifu, Aug. 1929; 1 ♀, Tseojiageo, S. of Suifu, Sep. 1929, 1400—2000 ft.; 1 ♀, near Yachow, 2 July 1930; 7 ♀, Kuanshien, 3000 ft., 1—4 Aug. 1934; 8 ♀ 2 ♂, Fulin, 2400 ft., 17—18 July 1928, 2 ♀, Ningyuenfu, 6000—6200 ft., 2—4 Aug. 1928; 2 ♀, Bet. Ginkeoho and Shinkaishi, 3—4 Aug. 1925; 1 ♀, Tsaekeo; all D. C. Graham coll. (USNM).

Taiwan. — 1 ♀, Taihorinsho, Aug. 1908, 1 ♀, Fuhosho, Sep. 1909, 2 ♀, Taihorinsho, Oct. 1909, 2 ♀, Fuhosho, Aug. 1909, 1 ♀, Kanshirei, 1908, all Suater (TMA); 1 ♀, Kuraru, 7 May 1934, L. Gressit (MCZ); 6 ♂ 1 ♀, Taipei-hsien, Wulai, 4 July 1966, 1 ♂, Nantou-hsien, Puli, 11 July 1966, 3 ♀, Taitung-hsien, Chulu, 12 Aug. 1966, 1 ♀, id., 29 June 1968, 2 ♀, Taitung-hsien, Chihpechi, resp. 13 Aug. 1966 and 30 June 1968, all leg. K. Tsuneki (RMNH).

Japan. — Chiba Pref., 1 ♀, Usui, Sakura City, 9 Sep. 1968, 1 ♀, Oamish irasato, Sanbu Gun, 10 Sep. 1970, 1 ♀, Kuriyama, Matsudo City, 22 Aug. 1963, 2 ♂, Mt. Kasamori, Chonan, 3 Sep. 1970, 1 ♂, Zenshoji Toke, Chiba City, 10 Sep. 1970, all leg. H. Suda (RMNH).

Vietnam. — 2 ♀, Ht. Tonkin, Phuung Lom, (J. J. M. Laisi) R. Oberthür 1901 (MNHN) (transitional between *S. d. deforme* and *S. d. femorale*; band on second tergite reduced, hind femur less dark than fore and middle).

### *Sceliphron deforme atripes* (Morawitz)

(figs. 32, 46, 116)

*Pelopoens atripes* Morawitz, 1888: 271, ♀ — Semipalatinsk (ZIL; examined).

*Sceliphron deforme*; Kohl, 1918: 122, 123, 133 (original description).

*Sceliphron formosum* var. *koreanum* Uchida, 1925: 329 (description in Japanese) (not examined).

*Sceliphron deforme koreanum*; Tsuneki, 1967: 6 (description ♀ ♂).

*Sceliphron (Prosceliphron) deforme atripes*; Bohart & Menke, 1976: 106.

*Sceliphron (Prosceliphron) deforme koreanum*; Bohart & Menke, 1976: 106.

Type. — The Zoological Institute at Leningrad possesses two syntypes of *P. atripes* Morawitz. The lectotype, by present designation, is a female, labelled "Semipalatinsk", "k. F. Morawitz" and "*atripes* ♀, F. Morawitz". The paralectotype is labelled "Semipalatinsk", "k. F. Morawitz" and "*Pelopoens atripes* ♀, F. Mora-

witz". It lacks forewings, antennae and the legs largely.

Description. — Morphology. — Post-antennal tubercles exceptionally large, dorsally truncate (fig. 32).

Coloration. — In the type-specimens, the colour-pattern is strongly reduced (fig. 46): the metasoma bears no yellow bands, and the mesosoma is almost entirely black; specimens from the Eastern part of the area occupied by this subspecies are more brightly coloured (fig. 47).

Material examined. — Mongolia. — 1 ♀ 1 ♂, Dinyuanin, s. Alashan, 5—14 Aug. 1908, Kozlow (ZIL); 1 ♀, Dundusaichan, Gobi, 9 July 1909, Kozlow (ZIL).

China. — 1 ♀, China, 801, 48, *curvatum* Sm det. Kohl (RMNH); 1 ♀, Peking, C. F. Wu coll. (BMNH); 1 ♀, Nord Peking, A. David, 1865 (MNHN); 1 ♀, "Chasyang", A. P. Jacot, Aug. 1921 (MNHN); 1 ♂, Petaiho Beach, Hopei Prov., Kina, 1942, A. M. Hemingston (RMNH); 1 ♀, Heishan, Liaching, C. F. Wu coll. (BMNH).

Korea. — 3 ♀, Geumgok, Jinyang-gun, Gyeongnam, July—Aug. 1984, 2 ♀, Mt. Jiri, 17 July 1984, all G. J. Jeong (RMNH); 1 ♂, Shoyozan, 30 May 1943, K. Tsuneki (RMNH); 3 ♀, Korea, Kim coll., (BMNH); 1 ♀, "Corea" (BMNH).

USSR. — 1 ♂ 3 ♀, Vladivostok, Sedanka, Malaise (NRS); 2 ♀, Vladivostok, Suchan, Malaise (NRS); 1 ♀, Ussuri (USNM); 1 ♀, Okeanskaya, Siberia, Aug. 1923, Cockerell (USNM); 1 ♀, Suputniskij zap-k., Primorskij Kraj, Lelej (RMNH) (45° N, 136° E); 1 ♀, Kongaus, Siberia, Aug. 1923, Cockerell (USNM); 2 ♀, Onon, Amour (MNHN); 2 ♀, Amour, Siberia (BMNH); 1 ♀, Okeanskaya, Ussuri, 3 July 1911, Cherskiu (ZIL); 1 ♀, Yakovlevka, Ussuri, 12 Sep. 1926, Diakonov Filipev (ZIL); 1 ♀, Primorje Dist., 20 km E. Ussurijsk, Goznotajozhnoje, 23 July 1983, E. Budrys (ZIL).

### *Sceliphron deforme nipponicum* Tsuneki

(fig. 48)

*Sceliphron deforme*; Kohl, 1918: 123 (Hokodadi); Tsuneki & Shimoyama, 1963: 48 (Towada dist., Honshu); Tsuneki, 1964: 10 (Mt. Kuju, Sasebo, Kyushu).

*Sceliphron deforme japonicum* Tsuneki, 1971: 7 (♀) (*nec japonicum* Gribodo).

*Sceliphron deforme nipponicum* Tsuneki, 1972: 1, ♀ — Prov. Fukui (Iwaya), paratypes ♀ ♂, Fukui,

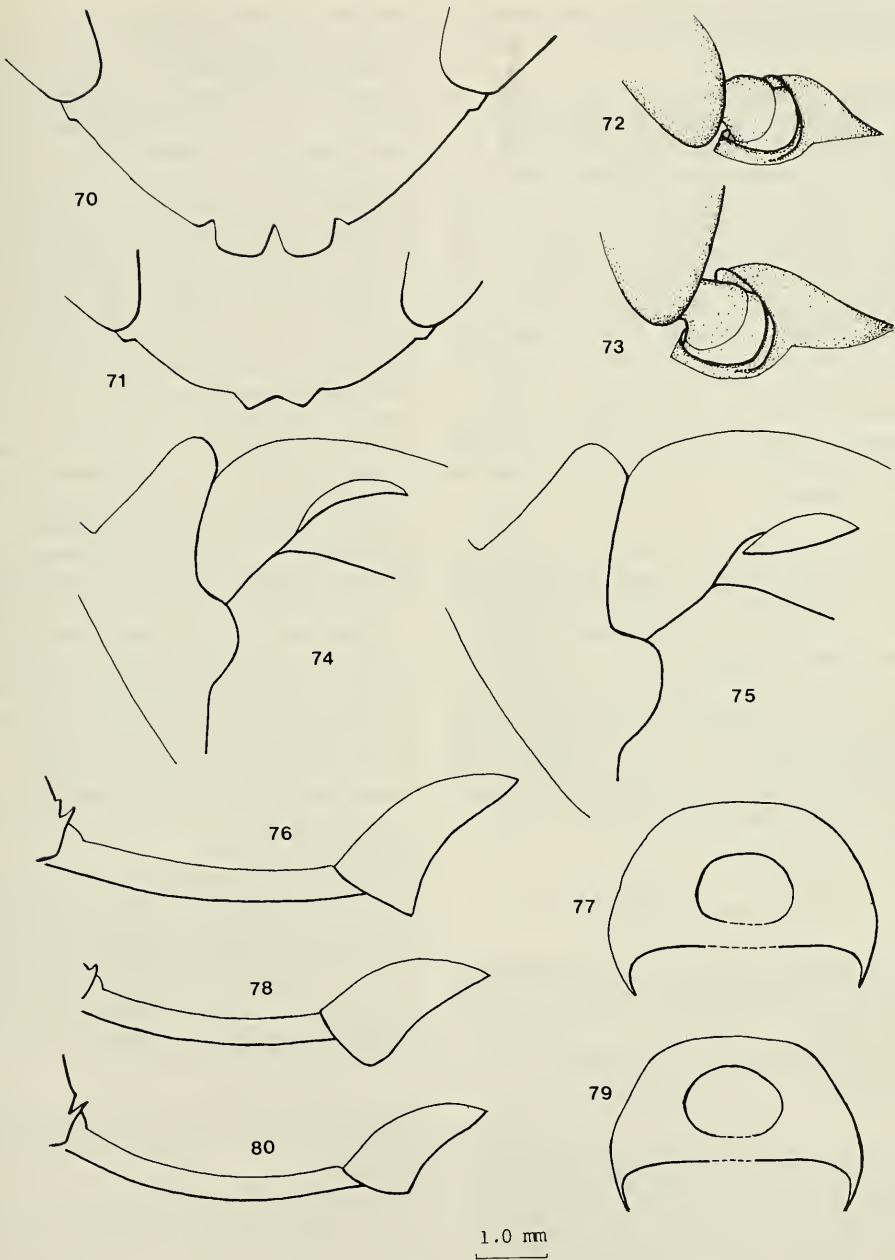

Figs. 70—80. *Sceliphron rufopictum* (Smith). 70, ♀, Indonesia, Celebes, clypeus; 71, ♂, Philippines, Luzon, clypeus; 72, *S. r. kalshoveni* ssp. n., ♀, holotype, antennal insertion; 73, *S. r. rufopictum* (Smith), ♀, antennal insertion; 74, *S. r. kalshoveni* ssp. n., ♀, holotype, pronotum, lateral aspect; 75, *S. r. laticinctum* ssp. n., ♀, holotype, pronotum, lateral aspect; 76—77, *S. r. rufopictum* (Smith), ♀; 76, first metasomal segment; 77, propodeal orifice; 78—80, *S. r. laticinctum* ssp. n.; 78, ♀, Philippines, Luzon, first metasomal segment; 79, ♀, Philippines, Luzon, propodeal orifice; 80, ♂, paratype, first metasomal segment. 70, 71, 76, 78, 80: scale-line; 74, 75: 2.0 × scale-line; 72, 73, 77, 79: 4.0 × scale-line.

several localities (coll. Tsuneki; not examined); Bohart & Menke, 1976: 106.

**Description.** — Female. — Post-antennal tubercles large, but distinctly smaller than in *S. d. atripes*, and not truncate dorsally; colour pattern (fig. 48) more or less like Eastern specimens of *S. d. atripes*; post-antennal tubercles black, scape dorsally black, subtegular spots small, basal propodeal spots absent; metasoma with the bands more or less darkened (brownish) and reduced; second to fifth sternite black; legs brownish black, with yellow streaks along fore and middle tibiae. The colour-pattern was described in full detail by Tsuneki (1971, 1972).

**Male.** — Like the female, but darker: clypeus sometimes entirely black, metasoma usually black, except for a narrow brownish band on the first tergite.

**Material examined.** — Japan. — Mt. Haku, 3 ♀, 1—2 Aug. 1953, 1 ♂, 1 Aug. 1962; 2 ♀, Fukui Pr., 8 Aug. 1953; 1 ♂, Nikko, 3 July 1952; 3 ♂ 3 ♀, Koike, Fukui, several dates; 2 ♂, Simoutinami, Fukui, 30 July 1971; 3 ♀, Arashi, Fukui, several dates; 1 ♀, Ichinose, Mt. Haku, 30 July 1964; 2 ♀, Hatogaya, Fukui, 29 Aug. 1969; all K. Tsuneki (RMNH); Tamba, 2 ♀, Yohoku, 23 July 1955, Higuchi, 1 ♀, Yakami, 23 July 1955, Honda, 1 ♂ 1 ♀, Sasayama, 15 July 1955 and 9 Sep. 1951, K. Iwata (all RMNH); 4 ♀, Japan, Smith coll. (BMNH).

***Sceliphron fervens* (Smith)**  
(figs. 49—60, 117)

*Pelopoens fervens* Smith, 1858: 101, ♀ — Borneo, Sarawak, leg. Wallace (OUM; examined).

*Sceliphron fervens*; Turner, 1912: 196; Kohl, 1918: 130, fig. 28.

*Sceliphron (Prosceliphron) fervens*; Bohart & Menke, 1976: 106.

**Type.** — The lectotype, by present designation, is a female in the OUM with only the original Wallace-label "SAR". The BM possesses three paralectotypes with additional labels "*P. fervens* Smith" in Smith's handwriting. Two of these have been part of Smith's own collection, according to their label "F. Smith coll., 99—363", the third is labelled "57—36, Borneo".

**Description.** — Body length: ♀ 15.3—16.5 mm, ♂ 14.5 mm; length of forewing: ♀ 10.6—

11.9 mm, ♂ 9.6 mm. Pubescence greyish white, tomentum of face silvery.

**Morphology: Female.** — Clypeus with lateral incisions (fig. 49); post-antennal tubercles small (fig. 50); pronotum with median impression; mesoscutum with sharp transverse striation; laterally with some shallow punctation; propodeal orifice with narrow dorsal margin, like in *S. deforme*, but not evenly rounded (fig. 51); petiolus moderately long, distinctly curved (fig. 57), first tergite distinctly swollen, like in *S. deforme*. IFR 0.88—0.95; PTR 0.92—1.00; PR 0.09—0.10; TR 0.26—0.30; SR 0.76—0.82. **Male.** — In structural characters like the female, but clypeal margin laterally from the small, triangular lobes shallowly emarginate (fig. 52), like in *S. deforme*; petiolus longer and more strongly curved (fig. 55); genitalia similar to those of *S. deforme*, but volsellar plate more differentiated and gonostyles apically not so sharply pointed (fig. 53, 54); the difference in the digitus is probably an artifact due to dehydration. IFR 0.95; PTR 1.12; PR 0.12; TR 0.29; SR 0.63.

**Coloration:** scapes dorsally black, post-antennal tubercles black, upper subtegular spot larger than lower, basal spots of propodeum small or absent, legs mainly reddish, mesosoma often reddish on basal tergites, a distinct yellow band is only present on the third tergite, sometimes the second and fourth bear reduced bands; wings clear, with well-defined dark mark at apex of forewing.

**Variation:** In specimens from Malaysia, Sumatra and Java the red colour on the metasoma is restricted to the first tergite, (fig. 58), whereas in most specimens from Borneo it covers three or more tergites (fig. 59); the one specimen from Palawan I have seen has a pair of spots at the apex of the dorsal enclosure, and the femora are entirely reddish (fig. 60).

**Distribution.** — Southern Thailand, Malaysia, Sumatra, Bangka, W. Java, Borneo, Palawan (fig. 117).

**Material examined.** — Thailand. — 1 ♀, Satun, Thaleban Nat. Park, 26 July 1986, R. Hensen (CH).

**Malaysia.** — 1 ♀, Kedah, near Jitra, 8 April 1982, 1 ♀, Perak, Batang Padang, Jor Camp, 1800 ft., 3 ♀ 1 ♂, Kuala Lumpur, Gardens, 22 March 1941, all H. M. Pendlebury (BMNH, RMNH); 1 ♀, Taiping, W. B. Orme (BMNH); 1 ♀, Labuang Padang, July 1907, C. B. H. Hunt



(BMNH); 1 ♀, Kuala Lipis, 29 May 1928, Miller (BMNH); Penang, Batu Feringgi, catchment area, H. T. Pagden, 1 ♀, 14 Feb. 1957, 1 ♀, 15 Feb. 1961 (BMNH); 1 ♀, Ulucheka, in jungle, 10 Aug. 1928, Miller (BMNH).

Bangka. — 1 ♀, Bangka, Van den Bossche (RMNH).

Sumatra. — 1 ♀, S. Sumatra, Res. Benkoelen, Boekit-Item, 24 June—2 July, 1935, 650 m, M. E. Walsh (RMNH); 1 ♀, Muara Sako, Oct. 1915, E. Jacobson (USNM).

Java. — 2 ♀, Radjamandala, Dec. 1938, J. v. d. Vecht (RMNH); 1 ♀, Radjamandala, Djampang Wetan, Oct. 1936, 1200 ft., M. E. Walsh (RMNH); 1 ♀, Palabocan Ratoe, 16 April 1933, M. Lieftrinck (RMNH).

Borneo. — 2 ♀, Bettotan, near Sandakan, 11 Aug. 1927 (BMNH); 1 ♀, E. Borneo, Ketapan, 50 m, June 1937, M. E. Walsh (RMNH); 1 ♀, Sarawak, Kampong Pueh, Lundu Dist., 690—1500 m, 25—31 May 1958, T. C. Maa (BPBM); ♀, S. E. Borneo, Wahnes S., Wolf v. Schönberg V. (ZMB).

Palawan. — 1 ♀, 3.2 km S. of Tarumpitao Pt., 31 May 1958, near jungle ravine, H. E. Milliron (USNM).

### *Sceliphron coromandelicum* (Lepeletier) (figs. 61—69, 115)

*Pelopoëus coromandelicus* Lepeletier, 1845: 306, ♀ — Coromandel (coll. Spinola, MZU).

*Sceliphron coromandelicum*; Dutt, 1912: 216—221, pl. XII, figs. 1, 7 (bionomics at Pusa, India); Field, 1914: 378—379 (bionomics); Strand, 1915: 91 (Sri Lanka); Kohl, 1918: 125, 126 (♀ ♂).

*Sceliphron (Prosceliphron) coromandelicum*; Van der Vecht & Van Breugel, 1968: 192 (type-species of *Prosceliphron*); Bohart & Menke, 1976: 106.

Type. — The Spinola-collection (MT) contains one female of this species, standing under the label "*Pelopoëus coromandelicus* m. et Lep.", which is most probably the holotype, since the description seems to be based on one specimen. Van der Vecht (pers. comm.) saw the specimen several years ago, and confirmed the general interpretation of the species, on which Kohl (1918) was not sure. The type is in poor condition, the head and mesosoma have been damaged severely by *Anthrenus*.

Description. — Body length: ♀ 17.4—21.0 mm, ♂ 16.4—19.5 mm; length of forewing: ♀ 11.9—13.3 mm, ♂ 10.8—11.7 mm. Pubescence: long, erect pubescence of head and mesosoma dark brown or black, but sometimes discolored

to pale brown in older specimens, short pubescence as usually white; tomentum of face silvery.

Morphology: Female. — Clypeus with small lateral incisions (fig. 65); post-antennal tubercles very small (fig. 63); pronotum with median impression, rather broad in lateral view (fig. 69); mesoscutum strongly transversely striate, only laterally with some shallow punctures; dorsal margin of propodeal orifice narrow (like in *S. deforme*), but not evenly rounded (fig. 64); petiolus long, sometimes as long as in *S. funestum*, but always distinctly curved (fig. 68). IFR 0.90—0.96; PTR 0.86—0.91; PR 0.05—0.08; TR 0.14—0.18; SR 0.67—0.74. Male. — Like the ♀, but clypeus evenly rounded, with small, triangular apical lobes (fig. 66); genitalia (fig. 61, 62); pubescence of cuspis dense, but shorter than in *S. rufopictum* and *S. formosum*, volsellar plate reduced, gonostyle with comparatively long and dense pubescence, the lamellae of the gonostyle are rather narrow. IFR 1.00—1.05; PTR 0.97—1.00; PR 0.07—0.08; TR 0.16—0.20; SR 0.51—0.66.

Coloration: Black; the following parts are yellow: two spots on the clypeus (often coalescent); ventral side of scape, more or less developed band on pronotum (absent in specimens from Malaya), very small subtegular spots; rarely a small spot on the scutellum and at apex of the propodeum; petiolus yellow, legs reddish yellow, except coxae, trochanters, base of fore and middle femora and terminal tarsomeres (hind tibiae black in a specimen from Laos).

Distribution. — India, Sri Lanka, Bangladesh, Burma, Thailand, Laos, Malaya (fig. 115). *S. coromandelicum* is at present the only species known to occur sympatrically with several other *Prosceliphron*-species: with *S. fervens* in Malaya, with *S. deforme femorale* in Thailand and Laos, with *S. deforme tibiale* and *S. rectum* in Northern India.

The ZMA possesses a series of 15 ♀ 2 ♂ from Coimbatore, India, which is almost completely stylized.

Material examined. — Sri Lanka. — 1 ♀, Puwakpitiya, Hiver 1906—7, E. Bugnon (MNHN); 1 ♀, Mon. Dist., Bibile, 7 June 1975, S. L. Wood & J. L. Petty (USNM); 1 ♀, Gal Dist., Kanneliya, 24—26 Jan. 1979, 1 ♀, Tri. Dist., Trincomalee, 0—100 ft., 13—17 May 1976, 2 ♀, Col. Dist., Labugama Res., 110 m, 29 Oct. 1977 and 11 July 1978, 1 ♀, Rat. Dist.,

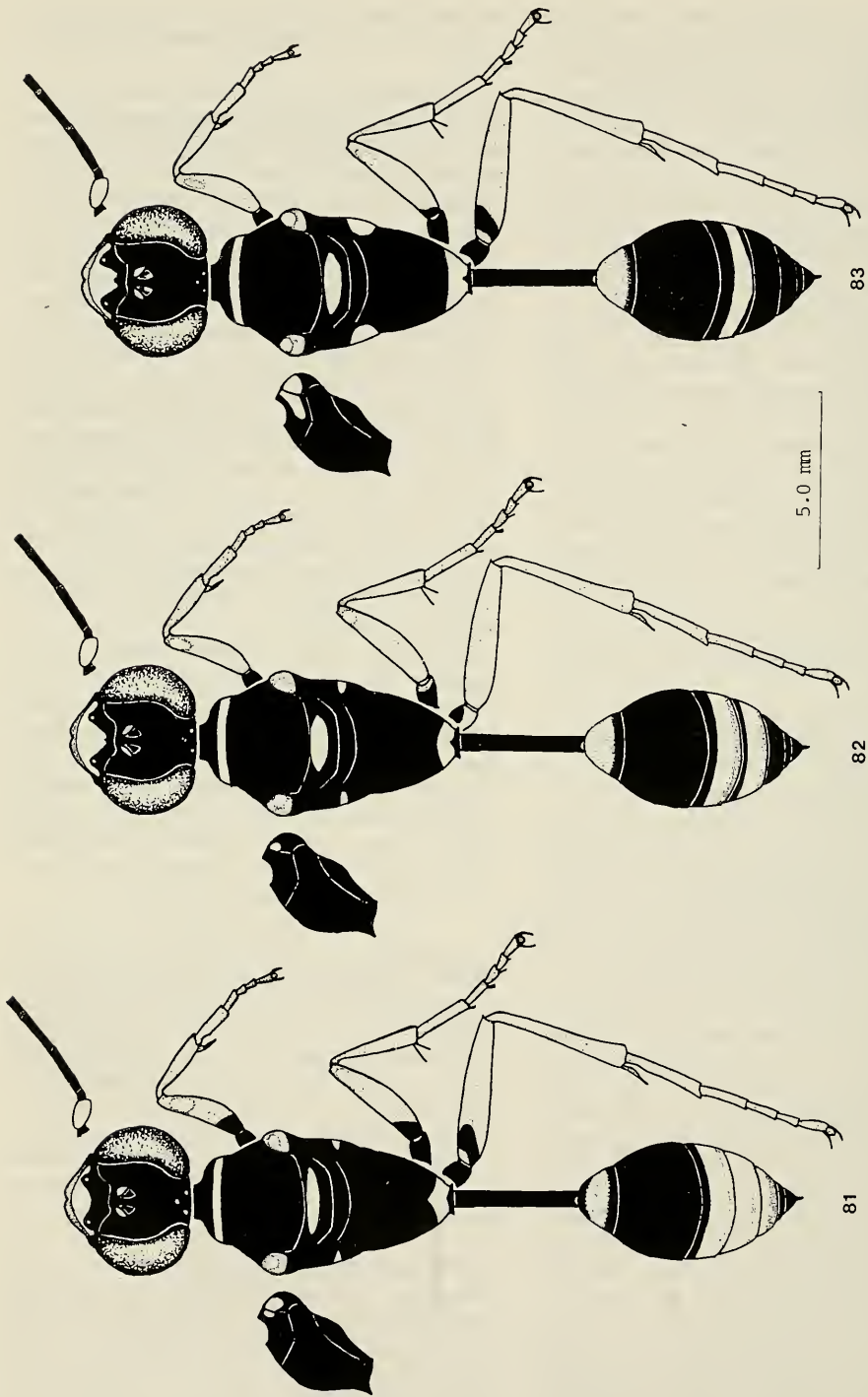

Figs. 81—83. *Scoliphron rufopictum* (Smith), colour patterns. 81, *S. r. kalsboveni* ssp. n., ♀, Indonesia, Java; 82, *S. r. bicinctum* Van der Vecht, ♀, Indonesia, Sumba; 83, *S. r. rufopictum* (Smith), ♀, Indonesia, Celebes.

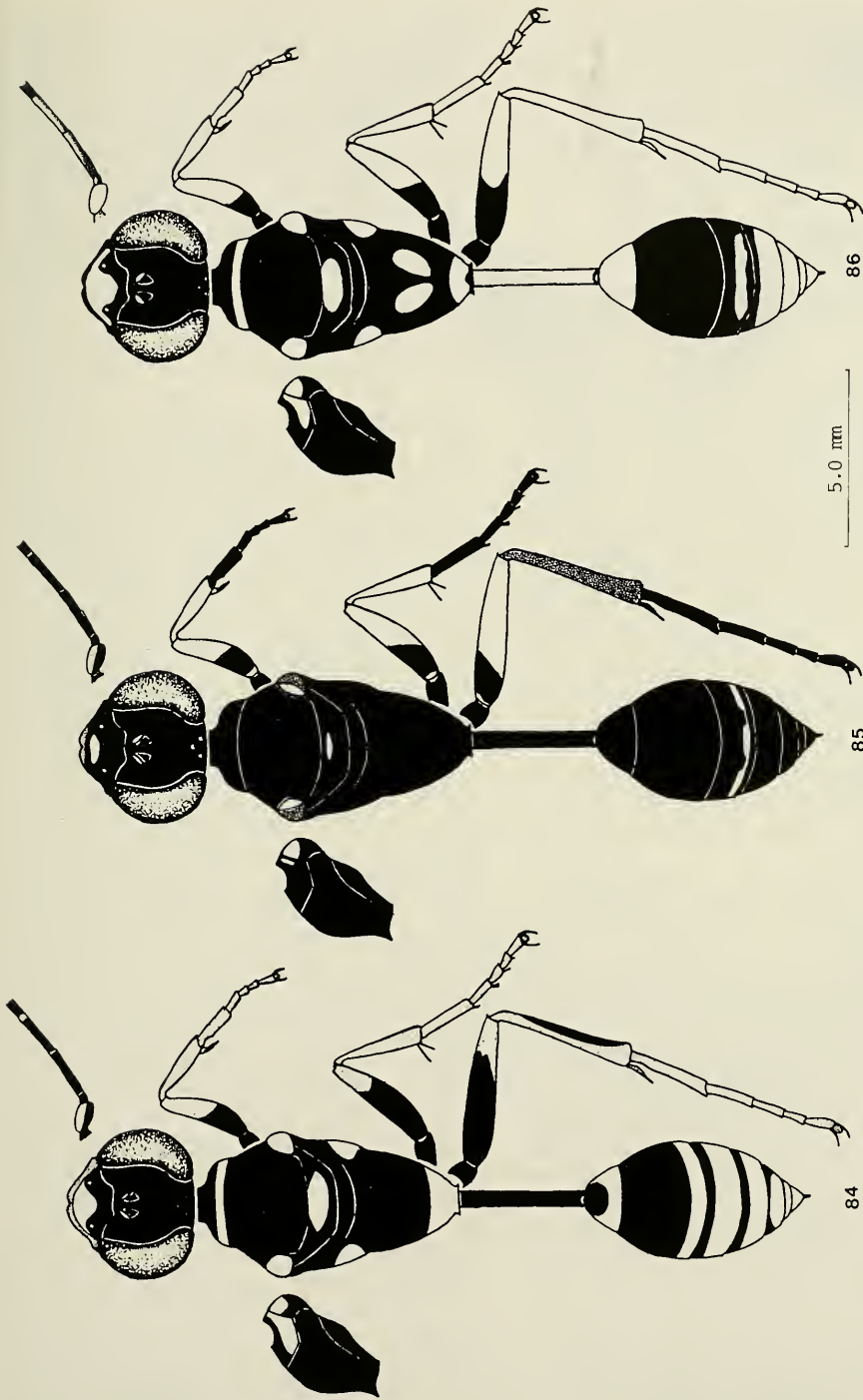

Figs. 84—86. 84. *Sceliphron rufopictum laticinctum* ssp. n., ♀, holotype, colour pattern; 85, *Sceliphron unifasciatum* (Smith), ♀, Indonesia, Morotai, colour pattern; 86, *Sceliphron f. formosum* (Smith), ♀, Australia, Queensland, colour pattern.





Figs. 87—95. 87—90. *Sceliphron murarium* (Smith), ♂, Indonesia, Ambon; 87, genitalia, ventral aspect; 88, inner side of left half of aedeagus; 89, clypeus; 90, first metasomal segment; 91—93, *S. murarium* (Smith), ♀, Indonesia, Ambon; 91, propodeal orifice; 92, clypeus; 93, first metasomal segment. 94—95, *Sceliphron unifasciatum* (Smith), ♀, Indonesia, Obi; 94, pronotum, lateral aspect; 95, first metasomal segment. 89, 90, 92, 93, 95; scale-line; 94: 2.0 × scale-line; 91: 4.0 × scale-line; 87, 88: 8.0 × scale-line.

Uggalkaltota, 23—26 June 1978, 1 ♀, Bad. Dist., Ulhitiya, 15 mi. NNE of Mahiyangana, 5—6 Sep. 1980, all leg. K. V. Krombein (USNM); 1 ♀, Rat. Dist., Udalawaya, 5—6 June 1975, D. H. Messersmith e.a. (USNM); 1 ♀, Col. Dist., Kollupitiya, 21—22 Nov. 1978, G. Ratnaweera (USNM); 1 ♀, Kantalai, 29 June 1953, F. Keiser (RMNH); 1 ♀, Col Dist., Labugama Res., 400 ft., 2—3 Oct. 1976, G. F. Hevel (RMNH); 1 ♀, Gal. Dist., Kanneliya, 28 July 1973, 300 ft., G. Ekis (RMNH); 1 ♀, M. Illupala, Jan. 1912, Butt.-Repp (ZMB); 1 ♀, Bibile, Bad. Dist., 1 ♀, Ruhuan Nat. Park, 5 Aug. 1963, both Univ. London Ceylon Exp. (BMNH).

India. — 3 ♀, Nilgiri Hills, Singara, 3400 ft., June 1948, 1 ♀, Walayar Forest, 100 ft., 18 Oct. 1947, 1 ♀, Kurumbagaram, 12 June 1947, 1 ♀, Coimbatore, Nov. 1950, all P. S. Nathan (USNM); 1 ♀, Balasore, R. Oberthür, 1898 (MNHN); 1 ♀, Mahé, Aug. 1892 (MNHN); 1 ♀, Ostindien, Dald (ZMB); 4 ♀ 1 ♂, Lonavla, W. Ghats, 650 m, 1 ♂, Sinhadgad, near Poona, 1320 m, all May 1963, F. Wain (RMNH); 1 ♀, Sangli (MBUD); 1 ♀, Calcutta, 6 June 1944, D. E. Hardy (USNM); 1 ♀, Karikal, Nov. 1961, P. S. Nathan (LACM); 1 ♀, Bangalore, 1894, Bingham (USNM); 7 ♀, Coimbatore, 1400 ft., 2 ♀, Anamalai Hills, Chinchona, 3500 ft., 1 ♀, Walayar Forest, 700 ft., all April-May 1960, P. S. Nathan (RMNH); 2 ♀, Orissa, 11 April 1965, S. D. Jayakar & H. Spurway (RMNH); 1 ♀, Khasia, 1 ♀, Bengalen, 1 ♀, Karivar, 6 Aug. 1907 (all RMNH); 1 ♀, Bengal (TMA); 15 ♀ 2 ♂ Coimbatore, 500 m, 7 April 1970, R. T. Simon Thomas (ZMA; 2 ♀ CH); Coimbatore, 425 m, 2 ♀, July 1963, 1 ♀, Nov. 1962, 1 ♀, April 1964, all P. S. Nathan (ZMA); 2 ♀, Karaikkal, June-July 1964, P. S. Nathan (ZMA); 6 ♀, Barrackpore, Rothney (OUM); 5 ♀, Bombay, W. Ghats, Mathera, Charlotte Lake, 1 April 1908, G. B. Longstaff (OUM); 1 ♂, India, 5 May 1909, E. Brunetti (BMNH); 2 ♀, Bombay, Matheran or Mableshwar, I. Newton (BMNH); 1 ♀, Coimbatore, 1925 (BMNH); 1 ♀, Thekkadi, Periyar Dam, Oct. 1938 (BMNH); 1 ♀, N. Khasia Hills (BMNH); 2 ♀, Coimbatore, June 1935, P. S. Nathan (BMNH).

Burma. — 10 ♀ 1 ♂, Rangoon Dist., 1 ♂, Tanagerim, Taungoo, all coll. Bingham (ZMB).

Thailand. — 1 ♀, Lee, 22 July 1952, D. & E. Graham (USNM); 1 ♀, near Metah Valley, J. D. H. Hedley (BMNH).

Laos. — 1 ♀, Sedone Prov., Pakse (15°10' N, 106°00' E), 15 Aug. 1967, native coll. (RMNH);

1 ♀, Indochine Francaise, Vitalis de Salveza, Mme A. Vuillet, 1920 (MNHN); 1 ♀, Vientiane, 30 April 1967, native coll. (BPBM).

Malaya. — 7 ♀ 4 ♂, Penang, ex nido, April 1966, H. T. Pagden (BMNH, RMNH); 1 ♂, with part of nest, from gun barrel, 21 Oct. 1980 (BMNH).

### *Sceliphron rufopictum* (Smith) (figs. 70—84, 96—97, 117)

Description. — Pubescence: Erect pubescence of head and mesosoma yellowish, tomentum of face pale-golden.

Morphology: Female. — Clypeus with lateral incisions (fig. 70); post-antennal tubercles variable in size; vertex sometimes raised; interocular distance at vertex shorter than or equal to length of first flagellomere; pronotal collar variable (figs. 74, 75); mesoscutum sharply transversely striate, only laterally with shallow punctation; propodeal orifice with broad dorsal margin, which is generally brownish translucent (figs. 77, 79); petiolus distinctly curved, shorter than hind tibia, first tergite moderately long, not swollen (figs. 76, 78). Male. — Similar to the female, but clypeus rounded, with small, triangular lobes (fig. 71); petiolus longer than hind tibia (fig. 80); genitalia (figs. 96, 97): gonostyles apically rounded, and with broad lamellae, cusps with rather dense and long pubescence laterally, volsellar plate rounded triangular.

Distribution. — Sunda-islands from Eastern Java to Flores, Celebes, Philippine Islands (fig. 117).

Four subspecies can be distinguished, differing in colour pattern as well as in a number of structural characteristics: 1) the size of the post-antennal tubercles, 2) the swelling of the ocellar area, 3) the broadness and median impression of the pronotum. These characters appear to vary clinally from South to North. Recognition of these clines led me to regard the geographic forms as conspecific. No conclusions could be drawn out of male genital structure, since only one male specimen was available.

### Key to the subspecies of *Sceliphron rufopictum* (Smith)

1. Post-antennal tubercles rather large (fig. 73), sometimes with yellow spot; subtegular and basal propodeal spots large (fig. 83, 84) . . . . . 2
- Post-antennal tubercles small (fig. 72),

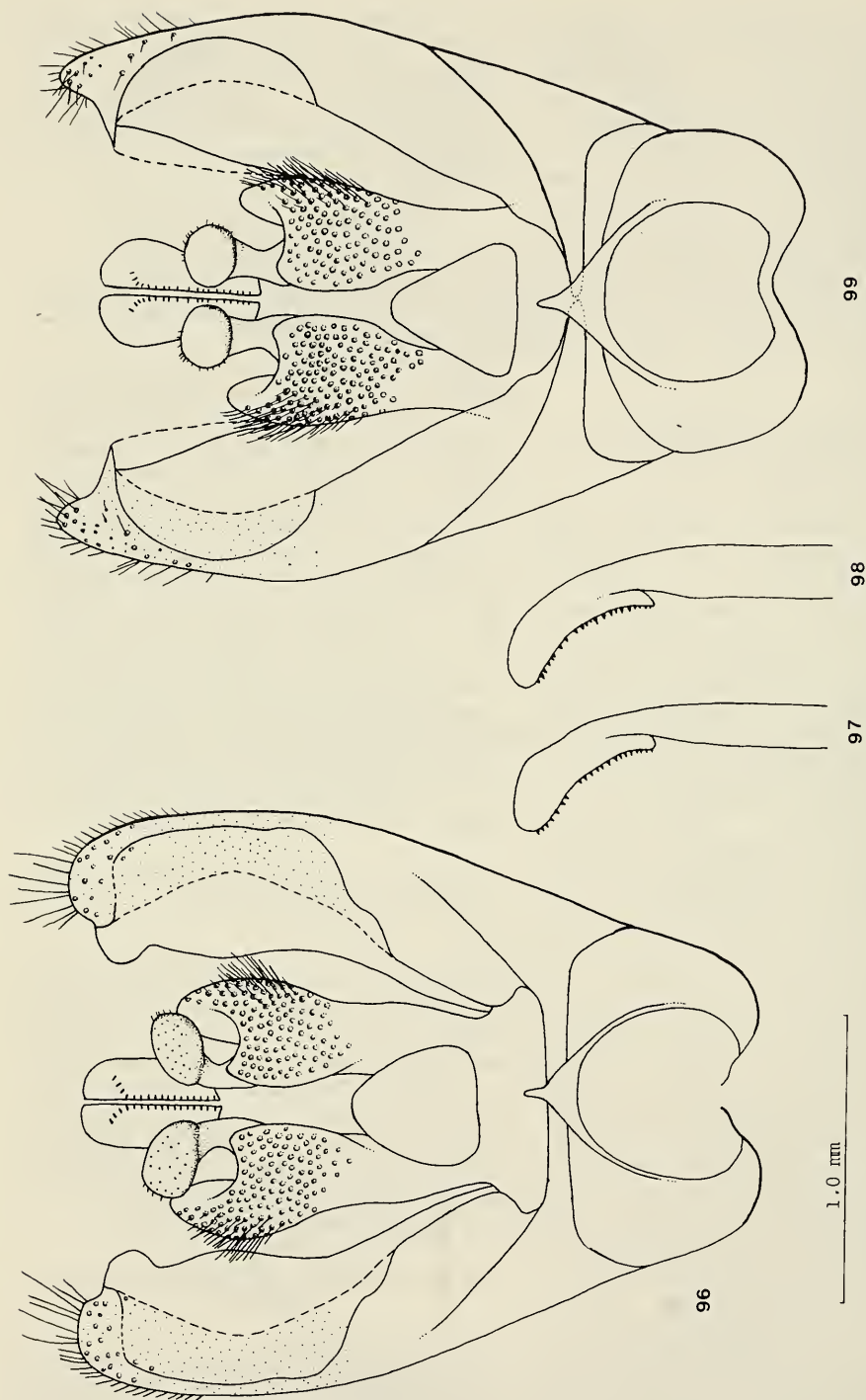

Figs. 96—99. 96—97. *Sceliphron rufopictum* laticinctum ssp. n., ♂, paratype; 96, genitalia, ventral aspect; 97, inner side of left half of aedeagus; 98—99, *Sceliphron ocellare* Kohl, ♂, Solomon Islands, Guadalcanal; 98, inner side of left half of aedeagus; 99, genitalia, ventral aspect.



black; subtegular and basal propodeal spots generally small . . . . . 3

2. Vertex raised behind anterior ocellus; usually tergites 2—5 with complete yellow band, antennal scape dorsally black; Philippine Islands . . . . . *laticinctum* ssp. n.  
— Vertex not or hardly raised; only third tergite with distinct apical band, antennal scape reddish dorsally; Celebes . . . . .

. . . . . *rufopictum* (Smith)  
3. Fifth tergite with yellow band, base of femora black (Java) or femora entirely reddish (Flores) . . . . . *kalshoveni* ssp. n.

— Fifth tergite black, femora totally reddish; Sumba . . . . . *bicinctum* Van der Vecht

**Sceliphron rufopictum kalshoveni** ssp. n.  
(figs. 72, 74, 81, 117)

Holotype. — ♀, M. Java, S. Coast, Patjitan, 12 Dec. 1937, J. van der Vecht (RMNH).

Description. — Body length 16.6 mm, length of forewing 10.7 mm.

Morphology. — Post-antennal tubercles small (fig. 72); ocellar area hardly raised; pronotal collar narrow (fig. 74), with distinct median impression; propodeal orifice rounded, upper margin very broad (cf. fig. 77).

Coloration. — Black; the following parts are yellow: broad spot on clypeus, antennal scapes, dorsal band on pronotum, spots on the tegulae, small subtegular spots, transverse spot on scutellum, very small basal propodeal spots, triangular mark at apex of propodeum, first metasomal tergite, and bands on tergites 2—5; legs light reddish, base of femora black, yellow spots at apex of fore and middle femora, yellow lines anteriorly on fore and middle tibiae (fig. 81).

Paratypes. — Java. — 1 ♀, Gedangan, 8 Sep. 1939, P. A. Blijdorp; 2 ♀, Gedangan, 18 Feb. 1933, Kalshoven; 1 ♀, Djati Rogo, Djati Forest, 100 m, M. E. Walsh; 1 ♀, Midden Java, with nest, Kalshoven (all RMNH).

Karimun Djawa Islands. — 2 ♀, 22—30 Nov. 1930, M. A. Lieftinck.

Not paratypes: Flores. — 2 ♀, W. Flores, Pater Verheyen, no. 116 (RMNH).

Variation. — Body length 16.6—18.8 mm, length of fore wing 10.8—12.3 mm; IFR 0.89—0.95; PTR 0.82—0.90; PR 0.04—0.07; TR 0.13—0.19; SR. 0.76—0.84. The specimens from Flores have the femora entirely reddish,

and the basal propodeal spots and the subtegular spots are comparatively large. These specimens are probably transitional between the subspecies *S. r. rufopictum*, *r. kalshoveni*, and *r. bicinctum*.

**Sceliphron rufopictum bicinctum** Van der Vecht  
(figs. 82, 117)

*Sceliphron deforme bicinctum* Van der Vecht, 1957: 370, ♀ — Sumba (Museum Basel; not examined).

*Sceliphron (Prosceliphron) deforme bicinctum*; Bohart & Menke, 1976: 106.

Description. — Body length 17.4—18.0 mm, length of forewing 11.0—11.2 mm.

Morphology. — Post-antennal tubercles small (cf. fig. 72); vertex not raised; pronotal collar with distinct median impression (cf. fig. 74); propodeal orifice rounded, with broad dorsal margin (cf. fig. 77). IFR 0.93—0.95; PTR 0.85—0.87; PR 0.07; TR 0.16—0.20; SR 0.71—0.75.

Coloration. — Post-antennal tubercles black, antennal scapes yellow, subtegular spots and basal propodeal spots small, femora, tibiae and tarsi reddish, first tergite reddish, third and fourth tergite with yellow apical band (fig. 82).

Material examined. — Sumba. — 1 ♀, W. Sumba, Pogobina, 16 Sep. 1949, 1 ♀, O. Sumba, Laluku, 4—7 July 1949, both leg. Dr Bühler & Dr Sutter (paratypes, RMNH).

**Sceliphron rufopictum rufopictum** (Smith)  
(figs. 73, 76—77, 83)

*Pelopoens rufopictus* Smith, 1856: 232, ♀ — Celebes (BMNH; examined).

*Pelopoens flavo-fasciatus* Smith, 1859: 15, ♀ — Celebes, leg. Wallace (OUM; examined).

*Sceliphron rufopictum*; Kohl, 1918: 129.

*Sceliphron deforme rufopictum*; Van der Vecht, 1957: 370.

*Sceliphron (Prosceliphron) deforme rufopictum*; Bohart & Menke, 1976: 106.

Types. — The lectotype of *P. rufopictus* Smith, by present designation, is a female labelled "Celebes, 55/22" in the BMNH, which is the only specimen old enough, according to label data, and which fits the original description. Previously a specimen with label "China, 56/45", belonging to *S. d. deforme* (Smith), was erroneously marked as the type.

The lectotype of *P. flavofasciatus* Smith, by present designation, is a female with labels

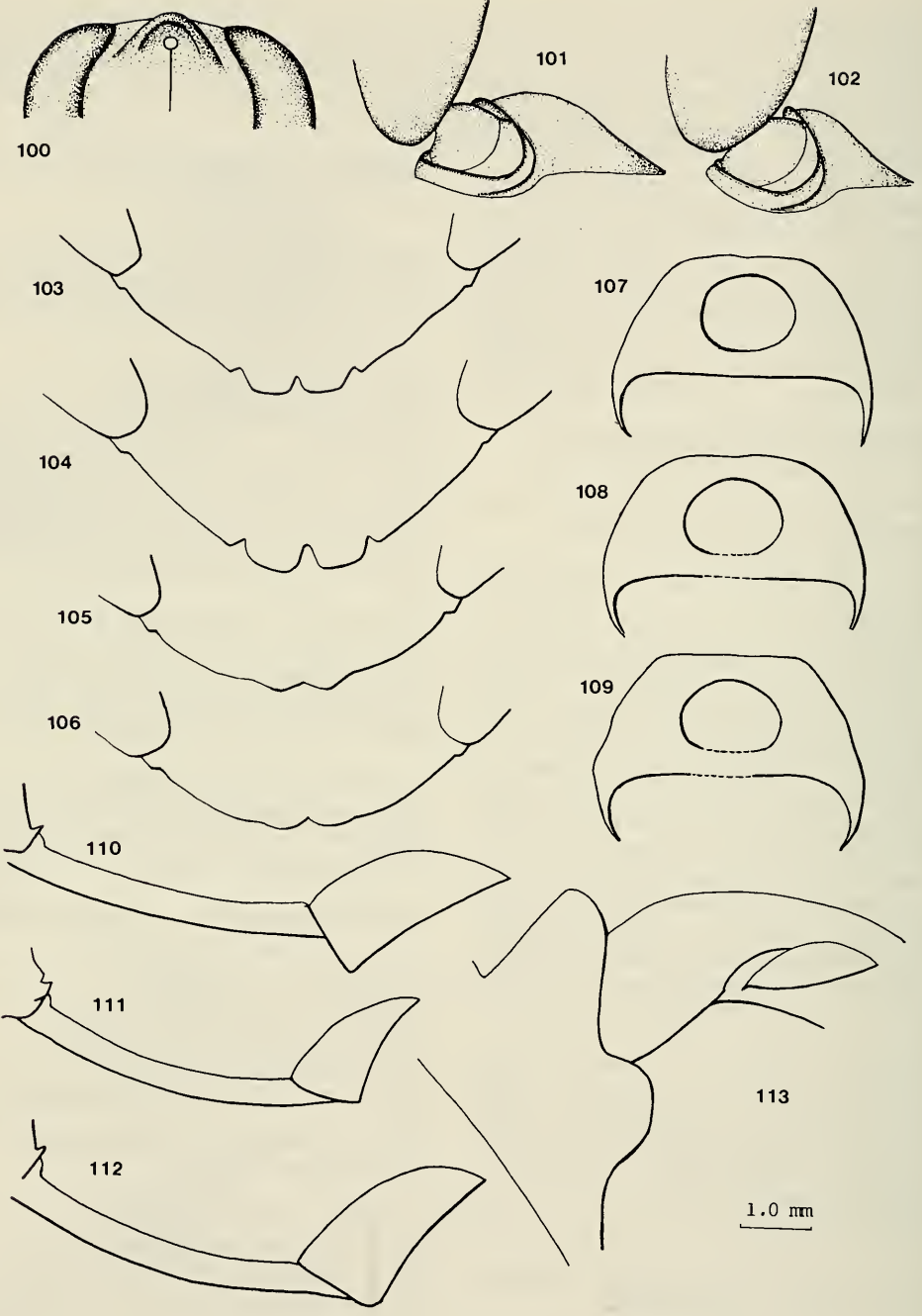



Fig. 114. Distribution of (1) *Sceliphron shestakovi* Gussakovskij, (2) *Sceliphron funestum* Kohl, (3) *Sceliphron rectum pulchellum* Gussakovskij, and (4) *Sceliphron r. rectum* Kohl.

“Celebes” and “*Pelopoëus flavo-fasciatus* Smith” (Smith’s handwriting) in the OUM. Paralectotypes are 2 ♀ with labels “Mak” (Makassar) (Wallace’s handwriting) and “*Pelopoëus flavofasciatus* Smith” (Smith’s handwriting) (BMNH and OUM). The specimen in the BMNH is additionally labelled “F. Smith coll., BM 79—22” and is stylized.

Description. — Body length 17.8—21.6 mm, length of forewing 11.4—13.7 mm.

Morphology. — Post-antennal tubercles rather large; vertex sometimes slightly raised behind anterior ocellus; pronotal collar with distinct median impression, rather broad in lateral view (fig. 75); dorsal margin of propodeal orifice rounded and broad (cf. fig. 77). IFR 0.84—0.96; PTR 0.76—0.85; PR 0.05—0.08; TR 0.14—0.18; SR 0.80—0.86.

Coloration. — Antennal scapes yellow; post-antennal tubercles usually with yellow spot;

Figs. 100—113. *Sceliphron formosum* (Smith). 100—101, *S. f. ocellare* Kohl, ♀, Solomon Islands; 100, upper part of head; 101, antennal insertion; 102, *S. f. formosum* (Smith), ♀, Australia, Queensland, antennal insertion; 103—106, clypeus; 103, *S. f. formosum* (Smith), ♀, Australia, Queensland; 104, *S. f. bruinjnii* (Maindron), ♀, N.W. Nw. Guinea; 105, *S. f. formosum* (Smith), ♂, Australia, Queensland; 106, *S. f. ocellare*, ♂, Solomon Islands; 107—109, propodeal orifice; 107, *S. f. formosum*, ♀, Australia, Queensland; 108, ♀, *S. f. ocellare* (Kohl), ♀, Solomon Islands; 109, *S. f. bruinjnii* (Maindron), ♀, Indonesia, New Guinea; 110—112, first metasomal segment; 110, *S. f. formosum* (Smith), ♀, Australia, Queensland; 111, 112, *S. f. ocellare* Kohl, ♂, Solomon Islands, 111, Nygela, 112, Guadalcanal; 113, *S. f. ocellare* Kohl, ♀, Solomon Islands, Malaita, pronotum, lateral aspect. 103—106, 110—112, scale-line; 100: 0.5 × scale-line; 113: 2.0 × scale-line; 101, 102, 107—109: 4.0 × scale-line.



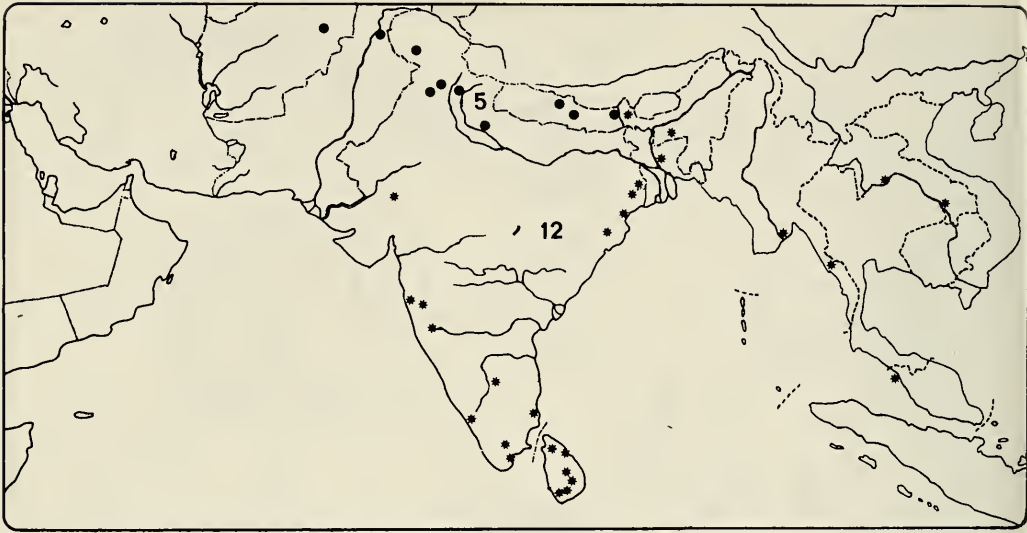

Fig. 115. Distribution of (5) *Sceliphron curvatum* (Smith), and (12) *Sceliphron coromandelicum* (Lepeletier).

subtegular and basal propodeal spots large; dorsal enclosure of propodeum sometimes with a pair of spots (N. Celebes); first tergite reddish, third with a broad yellow band apically; femora, tibiae and tarsi entirely reddish (fig. 83).

Material examined. — Celebes. — 1 ♀, Bua Kraeng, 5000 ft., Feb. 1896, 1 ♀, Samanga, Nov. 1895, both H. Frühstorfer (NMW); 1 ♀, Patunuang, Jan. 1896, H. Frühstorfer (ZMB); 1 ♀, Toelabella, Rosenberg (RMNH); 1 ♀, Lom-poh Batang, 200 m, 1941, H. Lucht (RMNH); 2 ♀, Manado, June and Aug. 1941, F. Dupont (RMNH); Bantimurung, 1 ♀, 3 Oct. 1931, J. van der Vecht, 1 ♀, July 1949, C. J. H. Franssen, 1 ♀, G. Ribbe, 1882 (all RMNH); 1 ♀, Lo-ka, 1200 m, C. J. H. Franssen (RMNH).

***Sceliphron rufopictum laticinctum* ssp. n.**  
(figs. 75, 78—80, 84, 96—97)

*Sceliphron deformis*; Williams, 1919: 122, fig. 59 (Luzon, bionomics); Rohwer, 1921: 675 (Luzon).

Holotype. — ♀, Los Baños, Philippine Isl., July-Aug. 1917, F. X. Williams coll. (RMNH).

Description. — Body length 18.3 mm, length of forewing 12.0 mm.

Morphology. — Post-antennal tubercles rather large, shiny (fig. 73); vertex moderately

raised behind anterior ocellus; pronotal collar evenly rounded, without traces of a median impression, rather broad in lateral view (fig. 75); mesosoma more regularly and finely sculptured than in the other subspecies, and more shiny, particularly the mesopleuron; propodeal orifice more or less trapezoid in outline, dorsal margin broad and brownish translucent (fig. 79).

Coloration. — Black, the following parts yellow: large spot on clypeus, scapes ventrally, broad band on pronotum, large transverse spot on scutellum, large subtegular spots, small spots on tegulae, basal spots and apical spot on propodeum, first metasomal tergite, except on the middle, apical bands on tergites 2—5 (the one on the second tergite less strong), faint bands on sternites 2—5; reddish are all tibiae, tarsi, and the apical 2/5 of the femora, but the last tarsomeres are infuscated, and the fore and middle tibiae bear a yellow stripe anteriorly. The colour-pattern is illustrated in fig. 84.

Measurements (entire type-series). — Body length 16.0—20.0 mm, length of forewing 10.8—13.0 mm; IFR 0.82—0.87; PTR 0.80—0.89; PR 0.08—0.09; TR 0.17—0.23; SR 0.76—0.88.

Male. — Body length 15.8 mm, length of forewing 10.6 mm. IFR 0.81; PTR 1.02; PR

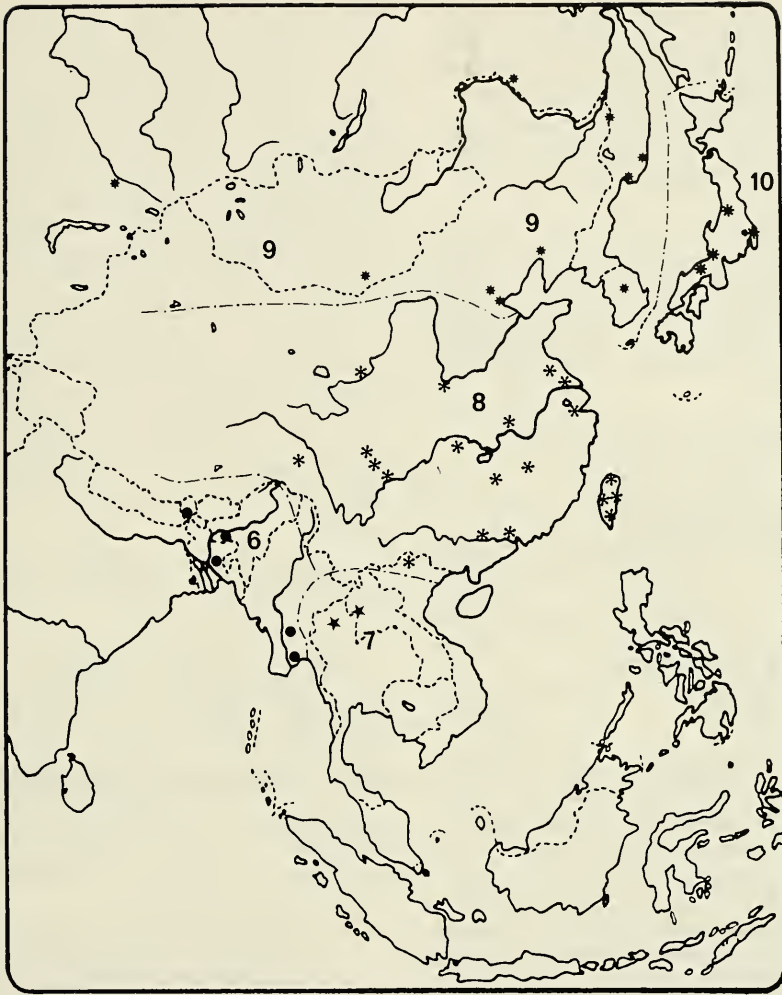

Fig. 116. Distribution of the subspecies of *Sceliphron deforme* (Smith): (6) *S. d. tibiale* Cameron, (7) *S. d. femorale* ssp. n., (8) *S. d. deforme* (Smith), (9) *S. d. atripes* (Morawitz), and (10) *S. d. nipponicum* Tsuneki.

0.10; TR 0.17; SR 0.60. Morphologically like the ♀, coloration see below (specimen from Cebu).

Paratypes. — Luzon. — Los Baños, 1 ♀, 23 Sep. 1915, V. S. Sulit; 1 ♀, 20 July 1921, C. Manuel, 2 ♀, 7 Sept. and 8 Nov. 1953, Townes Family, 1 ♀, 30 May 1954, H. & M. Townes, (all RMNH); 1 ♀, Limay, Bataan, Sep. 1920, 1 ♀, Camalia, Albay, 26 Aug. 1893, A. E. Bigornia, 1 ♀, Mt. Maquiling, 3 Feb. 1954, M. Delfinado, 1 ♀, Altimonan, Quezon, July 1963, A. Concepcion (all RMNH); 1 ♀, Montalban, Baker, 2 ♀, Mt. Maquiling, Baker (all USNM).

The following specimens are not included in the type-series. They originate from other islands of the Philippine Archipelago, and exhibit constant differences in colour-pattern. The specimens from Mindanao may even be regarded as transitional between *S. r. rufopictum* and *S. r. laticinctum*.

Samar. — 5 ♀, Island Samar, Baker (USNM). (With more or less distinct median impression on pronotum; antennal scape with narrow longitudinal black line dorsally; femora to a larger extent reddish).

Cebu. — 1 ♀ 1 ♂, Camp 7.25 km W. Cebu City, 21–29 Sep. 1965, D. Davis, 400 m

(USNM). (Pronotal collar with median impression, antennal scape with black line dorsally, only third tergite with distinct apical band; first and second tergite of male partly reddish, fore and middle tibiae of male posteriorly black).

Biliran. — 1 ♀, Island Biliran, Baker (USNM). (Hind tibiae reddish, broad band on second tergite).

Mindanao. — 4 ♀, Dapitan, Baker (USNM); 1 ♀, Davao, April 1927, M. C. Gregory (BMNH). (Distinct median impression on pronotum, large yellow spots on fore and middle femora and large spots on dorsum of propodeum (like *S. r. rufopictum*-specimens from North Celebes)).

### *Sceliphron murarium* (Smith)

(figs. 87—93, 117)

*Pelopoëus murarius* Smith, 1863: 34, ♀ — Ceram, leg. Wallace (OUM; examined).

*Pelopoëus rufipes* Mocsary, 1883: 24, ♀ — Ambon (TMA; not examined) (nec *rufipes* Fabricius, 1804).

*Sceliphron mocsaryi* Dalla Torre, 1894: 388 (new name for *P. rufipes* Mocsary).

*Sceliphron rufipes*; Kohl, 1918: 131.

*Sceliphron (Prosceliphron) fervens murarium*; Bohart & Menke, 1976: 106.

Type. — In the Saunders-collection (OUM) two specimens are standing under this species. One of these is a female with labels "Cer." and "*Pelopoëus murarius* Smith" (Smith's handwriting). This specimen is the lectotype by present designation. The other specimen belongs to *S. formosum bruinjnii* (Maindron) and is a male, labelled "N." and "*Pelopoëus murarius* Smith male?" (Smith's handwriting). It was evidently not part of the original type-series.

Description. — Body length: ♀ 17.8—21.0 mm, ♂ 16.8—17.7 mm; length of forewing: ♀ 12.5—14.0 mm, ♂ 11.5—12.1 mm. Pubescence: erect pubescence of head and mesosoma dark brown; tomentum of face golden.

Morphology: Female. — Clypeus with lateral incisions (fig. 92); post-antennal tubercles very small (cf. fig. 50); vertex not raised; pronotum with distinct median impression, high and narrow in lateral view, like in *S. unifasciatum* (fig. 94); mesonotum sharply transversely striate, only laterally with a trace of punctation; propodeal orifice nearly circular in outline, dorsal margin very broad (fig. 91), and brownish translucent; petiolus rather short (shorter than in *S. unifasciatum* and *S. rufopictum*), first ter-

gite long but not swollen (fig. 93). IFR 0.81—0.88; PTR 0.71—0.75; PR 0.06—0.07; TR 0.15—0.22; SR 0.80—0.95. Male. — In most respects like the female, but clypeus rounded, with small triangular lobes (fig. 89); petiolus long, strongly curved (fig. 90); genitalia (fig. 87, 88) like those of *S. rufopictum*, but more stoutly built, with shorter aedeagus and gonostyles, and more strongly curved digitus, however with the same dense flock of setae laterally on the cuspis. IFR 0.89—0.93; PTR 0.83—0.89; PR 0.08—0.09; TR 0.16—0.17; SR 0.65—0.70.

Coloration. — Sufficiently described by Kohl (1918) after the type of *S. rufipes* Mocsary. Most important traits are the absence of yellow markings on the mesosoma, except for occasional traces of a band on the pronotum; the first and second tergite and the second sternite are reddish, the remaining tergites more or less fuscous apically.

Distribution. — Endemic to the Southern Moluccas (fig. 117).

Material examined. — Ambon. — 1 ♀, Ambon (RMNH); 4 ♀, Ambon, Waai, 1—50 m, 12—26 May 1965, 2 ♀, 1 ♂, Ambon Isl., 70 m, resp. 10 and 26 Nov. and 23 Sep. 1960, 3 ♀, Ambon, 70 m, resp. 22 Jan., 1 April and 7 May 1961, all A. M. R. Wegner (RMNH); 10 ♀ 1 ♂, Ambon, Waai, different dates, A. M. R. Wegner (BPBM).

Ceram. — 1 ♀, West Ceram, April—June 1910, Van Dalen (ZMA).

### *Sceliphron unifasciatum* (Smith)

(figs. 85, 94—95, 117)

*Pelopoëus unifasciatus* Smith, 1861: 123, ♀ — Batjan, leg. Wallace (OUM; examined); Kohl, 1918: 129 (in synonymy of *S. rufopictum*).

*Pelopoëus affinis*; Maindron, 1878: 395, pl. IX, fig. 9, ♀ — Halmheira (MNHN) (nec *Sphex affinis* Fabricius, 1793); Kohl, 1918: 129 (doubtful synonym of *S. rufopictum*), 132 (original description).

*Sceliphron (Prosceliphron) deforme unifasciatum*; Bohart & Menke, 1976: 106.

Type. — There is one specimen of this species in the Saunders-collection (OUM), labelled "Bac" (Batjan) and "*Pelopoëus unifasciatus* Smith" (Smith's handwriting), which I regard as the holotype.

Description. — Body length 18.2—19.5 mm; length of forewing 12.1—13.1 mm. Pubescence: erect pubescence of head and mesosoma purely





Fig. 117. Distribution of (11) *Sceliphron fervens* (Smith), (13) *S. rufopictum kalshoveni* ssp. n., (14) *S. r. bicinctum* Van der Vecht, (15) *S. r. rufopictum* (Smith), (16) *S. r. laticinctum* ssp. n., (17) *S. murarium* (Smith) and (18) *S. unifasciatum* (Smith).

white, not yellowish as in *S. rufopictum*; facial tomentum silvery.

**Morphology.** — Clypeus with lateral incisions (cf. fig. 92); post-antennal tubercles very small; vertex not raised; pronotal collar high and narrow in lateral view (fig. 94), medially impressed; mesoscutum sharply transversely striate, laterally with shallow punctation; propodeal orifice more or less rectangular, dorsal margin very broad (like fig. 91); petiolus distinctly curved, longer than in *S. murarium*, first tergite rather long, but not swollen (fig. 95). IFR 0.88–0.90; PTR 0.72–0.78; PR 0.07–0.08; TR 0.17–0.21; SR 0.85–0.93.

**Coloration.** — Clypeus black or with small yellow spot; pronotum usually with narrow, interrupted yellow band; small subtergular spots present, and usually a small spot on the scutellum; metasoma sometimes with central yellow spot on the first tergite, and usually with band

on the third tergite. There is considerable variation in colour-pattern between the different island-populations; the colour-pattern of a specimen from Morotai is illustrated in fig. 85.

The ♂ of this species is unknown.

**Distribution.** — Endemic to the Northern Moluccas (fig. 117).

**Material examined.** — Halmahera. — 1 ♀, Kao Dist., Kampung Tolwang, 1–14 March 1981, A. C. Messer & P. M. Taylor (USNM) (scutellum only with very small spot, first tergite black).

Morotai. — 2 ♀, Morotai, Bernstein (RMNH) (pronotum black, first tergite black (fig. 85)).

Obi. — 2 ♀, W. Obi, Lake Riv., 0–50 m, July–Nov. 1953, A. Wegner (RMNH) (pronotum black, scutellum black, all tergites black).

**Sceliphron formosum** (Smith)  
(figs. 86, 98—113, 118)

Description. — Body length: ♀ 15.4—20.7 mm, ♂ 15.2—18.7 mm; length of forewing: ♀ 10.8—12.7 mm, ♂ 11.0—12.3 mm. Pubescence: erect pubescence of head and mesosoma yellowish, facial tomentum golden.

Morphology: Female. — Clypeus with more or less distinct lateral incisions (figs. 103, 104); post-antennal tubercles variable in size; vertex strongly raised in one subspecies; pronotal collar with median impression, which may be very shallow; mesoscutum transversely striate, but less sharply than in other species, except *S. curvatum*, moreover with distinct punctuation between the striae; propodeal orifice with rather broad dorsal margin (figs. 107—109), which is often yellowish or brownish translucent; petiolus distinctly curved, shorter than hind tibia, first tergite short and slender (fig. 110). IFR 0.87—1.05; PTR 0.76—0.88; PR 0.06—0.08; TR 0.15—0.20; SR 0.71—0.88. Male. — Like the female, but clypeus rounded, with hardly a trace of lobes, medially emarginate (figs. 105, 106); petiolus about as long as the hind tibia (figs. 111, 112); genitalia (figs. 98, 99): gonostyles pointed, digitus comparatively long and slender, volsellar plate distinctly triangular. IFR 0.93—1.05; PTR 0.88—1.02; PR 0.08—0.10; TR 0.12—0.18; SR 0.55—0.76.

Distribution. — New Guinea, Bismarck-Archipelago, Solomon Islands, Northern and Eastern Australia (fig. 118).

This species consists of three distinct geographic forms, which differ in colour as well as in some structural details; the large area in which intergradation occurs, however, proves that these forms do not merit specific status. The transitional specimens (from Southern and Eastern New Guinea) are provisionally divided over the subspecies.

Key to the subspecies of *Sceliphron formosum*  
(Smith)

1. Second tergite black, or with strongly reduced band; usually the sternites are black, the petiolus and the antennal scape yellow; Australia, S. New Guinea ..... *formosum* (Smith)
- All tergites with complete yellow bands; sternites with yellow bands or lateral spots; petiolus usually black; scape dorsally black ..... 2

2. Vertex raised (fig. 100); post-antennal tubercles and tegulae with yellow spot; only first tergite partly red; Bismarck-Archipelago, Solomon-Islands, E. New Guinea ..... *ocellare* Kohl
- Vertex not raised; post-antennal tubercles and tegulae black; often all tergites with reddish ground-colour; N. and W. New Guinea ..... *bruinjii* (Maindron)

**Sceliphron formosum bruinjii** (Maindron)  
(figs. 104, 109, 118)

- Pelopoëus bruinjii* Maindron, 1878: 394, pl. 9: 10, ♀ — Manokwari ("Dorey") and Anday, New Guinea (MNHN; examined).
- Sceliphron bruinjii*; Cameron, 1906: 221 (Merauke, Etna Bay); Kohl, 1918: 134.
- Sceliphron bruynii* Cameron, 1906: 56 (emendation).
- Sceliphron (Pelopoëus) fallax* Kohl, 1918: 129, ♀ ♂ — Stephansort, Astrolabe Bay, New Guinea (NMW; examined).
- Sceliphron (Prosceliphron) bruinjii*; Van der Vecht & Van Breugel, 1968: figs. 2—4 (genitalia of ♂).
- Sceliphron (Prosceliphron) bruinjii*; Bohart & Menke, 1976: 106.

Maindron dedicated this form to Mr. "Bruijn" at Ternate, whose actual name was "De Bruyn". Cameron's emendation however is incorrect, since in the original publication there is no evidence of this error.

Types. — The Paris Museum possesses the two syntypes of *P. bruinjii*. The female with labels "Dorey" and "Raffray & Maindron, Dorey, Nouvelle Guinée" is herewith designated as the lectotype. The paralectotype is labelled "Nouvelle Guinée, Andaie, Mai 1878".

The Vienna Museum possesses three syntypes of *S. fallax*. The lectotype, by present designation, is a female with labels "N. Guinea, Biró 97", "Stephansort, Astrolabe B." and "*Sc. fallax* Kohl". The male paralectotype is labelled equally; the female paralectotype lacks Kohl's identification-label.

Description. — Morphology. — Vertex not or slightly raised; post-antennal tubercles rather large (cf. fig. 101); propodeal orifice often distinctly trapezoidal in outline, with the dorsal margin straight (fig. 109).

Coloration. — Rather variable; the type is a brightly coloured specimen, with large subtegular spots, basal propodeal spots and broad bands on the tergites and sternites; the first and the second tergites are almost entirely reddish. Other specimens, like the type-series of *S. fallax*, are

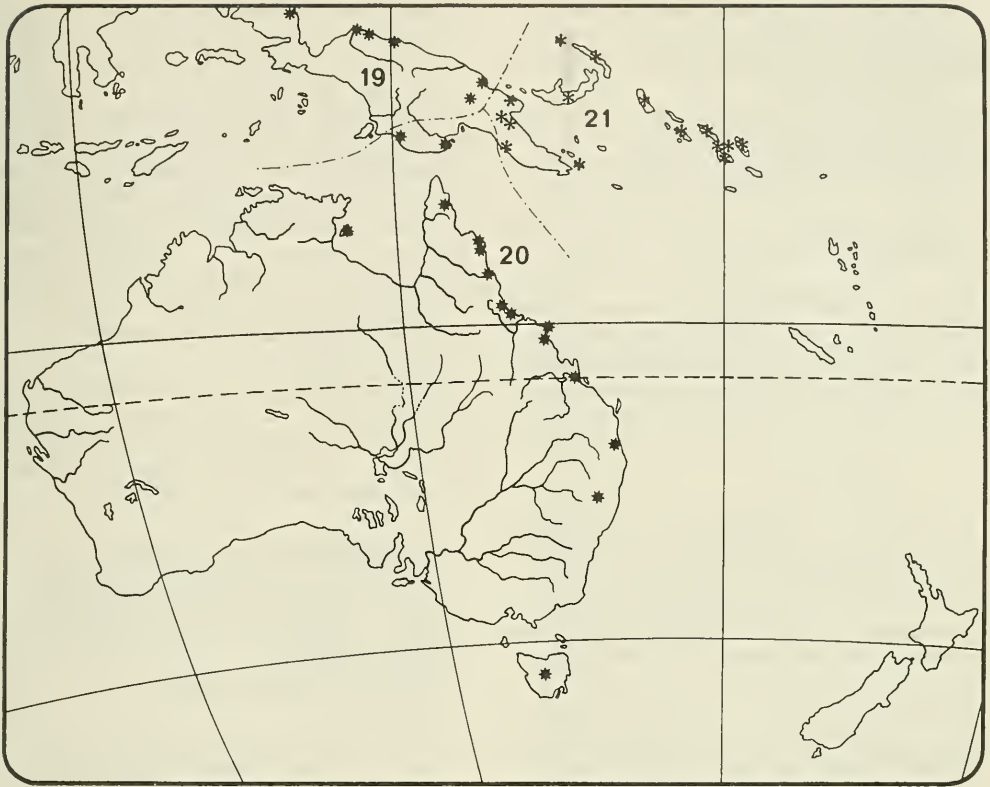

Fig. 118. Distribution of the subspecies of *Sceliphron formosum* (Smith): (19) *S. f. bruinjui* (Maindron), (20) *S. f. formosum* (Smith), and (21) *S. f. ocellare* Kohl.

darker, without subtegular spots, without red parts on the metasoma, and with the bands on the tergites and sternites very narrow.

Material examined. — New Guinea. — 1 ♀, Manokwari, 23 May 1903 (ZMA); 1 ♀, Pionierbivak, July 1920, W. C. van Heurn, 1 ♀, Hatram, Utrechts Zendinggenootschap, 1 ♀, Tami River, Hollandia, 1920, R. Voorhoeve (all RMNH); Ifar, 2 ♀, 1 March 1957, 1 ♀ 2 ♂, 5 Dec. 1956, 1 ♀, 1 Oct. 1958, 1 ♀, 1 March 1959, all J. van den Assem (RMNH); 1 ♀, Humboldt Bay, Hollandia, April 1936, L. E. Cheesman, 1 ♀, Hollandia, Jan. 1937, 300–600 m (BMNH); 1 ♀, Fiume, Purari, Loria, Jan. 1894 (Mus. Genoa); 1 ♀, Dorey, Humboldt Bay, 1906, O. K. Pasteur (MNHN); 1 ♀, Medang Dist., Wanuma, 600–720 m, Aug. 1968, J. Sedlacek (BPBM).

The following specimens are transitional between this subspecies and *S. formosum ocellare*:

New Guinea. — 1 ♀, Kwamkwam, 90 km NW. Finschhafen, 18 Jan. 1973, K. W. Ströder (RMNH); 1 ♀, Wau, Morobe Dist., 1150 m, 17 May 1962, J. Sedlacek (BPBM): these specimens have the vertex slightly raised, the post-antennal tubercles are rather large and marked with yellow, the tegulae bear very small yellow spots, the metasoma however is largely red; 1 ♀, Wau, 1200–1400 m, 18–26 Sep. 1972, J. van der Vecht (RMNH); 1 ♀, Hohola, Pt. Moresby, Central Dist., 30 May 1966, in ornamental garden (RMNH); 1 ♂, Port Moresby, emerged from mud-nest (Australian Museum): these specimens have the vertex slightly raised, the post-antennal tubercles are large, and the tegulae bear small yellow spots; 1 ♀, Bulolo, 700 m, 6 Nov. 1969, J. Sedlacek (BPBM); 1 ♀, Simbang, Huon Golf, Biró, 1900 (*S. ocellare*, type, det. Kohl) (NMW): like the previous, but with additional yellow spot on the post-antennal tubercles.



**Sceliphron formosum formosum** (Smith)  
(figs. 86, 102—103, 105, 107, 110, 118)

*Pelopoëus formosus* Smith, 1856: 230, ♀ — Australia (BMNH; examined).

*Sceliphron papuanum* Cameron, 1906: 221, ♀ — New Guinea, Merauke (ZMA; examined).

*Sceliphron (Pelopoëus) formosus*; Kohl, 1918: 126—128 (♀ ♂), 138 (original description *S. papuanum*).

*Sceliphron (Prosceliphron) formosum*; Bohart & Menke, 1976: 106.

Type. — The lectotype, by present designation, is a female with labels "Port Essington" and "*formosus* Sm., type" in Smith's handwriting. Another specimen, labelled "type, F. Smith coll. 79—22" is probably not a type-specimen: it does not agree with the description, and may be of a later date.

Description. — Morphology. — Typically the post-antennal tubercles are small (fig. 102), the vertex is not raised, and the clypeus has distinct lateral incisions in the female (fig. 103).

Coloration. — As described by Kohl (1918); the characteristic traits are: post-antennal tubercles black, pronotal band not interrupted, propodeum with yellow spots at apex of dorsal enclosure, petiolus yellow, second and usually third tergite black, sternites 2—5 black (fig. 86).

Variation. — In some N. Australian specimens the petiolus is black, and the sternites bear yellow lateral spots; the spots at apex of the dorsal enclosure may be absent; in the extreme North of Australia the morphology tends to be transitional between *formosum* and *ocellare*: the post-antennal tubercles are larger and the vertex is slightly raised.

Distribution. — Southern New Guinea, Eastern parts of Australia (fig. 118). The occurrence in Tasmania is doubtful. Kohl (1918) mentions also Ceram and Ternate, without reference to specimens or literature, but this is almost certainly incorrect.

Material examined. — Australia. — 1 ♀, S. E. Queensland, 14 Feb. 1957, A. R. Steginga (ZMA); 2 ♀, Australia, Feb. 1847, Vereaux (MNHN); 3 ♀, Tasmania, 1846, Vereaux (MNHN); 1 ♀, Nov. Hollande, Gory (MNHN); 2 ♀, Feb. 1900, R. E. Turner (BMNH); 1 ♀, Stradford, Barron River, 17 Jan. 1972, 1 ♀, Cairns, 30 Jan. 1972, both L. Oosterweghel (RMNH); 1 ♀, Australia boreal (RMNH); 1 ♀, N. S. Wales (RMNH); 2 ♀,

Brisbane, March 1944, E. F. Riek (USNM); 2 ♀, Stradbroke Island, 5 Dec. 1913, 1 ♀, Brisbane, 21 Dec. 1912, both E. F. Riek (USNM); 1 ♀, Halifax, Feb. 1913, Girault, 1 ♀, Cairns, 1 ♀, Sunnybank, 1 Dec. 1951, E. F. Riek (all USNM); 15 ♂ 10 ♀, Mackay, Jan. 1901, R. E. Turner (BMNH); 1 ♀, Townsville, 1 March 1902, F. P. Dodd (BMNH); 2 ♀, Tamworth, 25 Jan. 1960, M. Edwards (BMNH); 2 ♀, Elalie, S. of Elaggy, 9 Nov. 1917, L. Oosterweghel, 1 ♀, Terra van Diemeni, Parzudaki, 1 ♀, Nov. Holl. (all RMNH); 1 ♀, Claudie R., 5 Mls. W. Mt. Lomond, Queensland, 23 Dec. 1971, D. K. McAlpine (USNM).

New Guinea. — 1 ♀, New Guinea Exp. 1905/6, Merauke (ZMA; holotype of *S. papuanum* Cam.); 1 ♀, Eramboe, 80 km ex Merauke, 5 Feb. 1960, T. C. Maa (BPBM); 1 ♀, Pt. More-sby area, May 1947, L. Jones (BMNH).

**Sceliphron formosum ocellare** Kohl  
(figs. 100—101, 106, 108, 111—113, 118)

*Sceliphron (Pelopoëus) ocellare* Kohl, 1918: 128, ♀ — Bismarck-Archipelago, Ralum (? ZMB) and Kiginang (? NMW).

*Sceliphron (Prosceliphron) ocellare*; Bohart & Menke, 1976: 106.

Type. — I have seen a specimen labelled by Kohl as "type", but it originates from New Guinea, and thus cannot be considered a type-specimen. No other type-material could be found in the NMW, and neither in the ZMB and TMA.

Description. — Morphology. — Lateral incisions in clypeus of female usually less developed than in other subspecies; post-antennal tubercles rather large (fig. 101); vertex moderately to strongly raised behind anterior ocellus (fig. 100).

Coloration. — As described by Kohl (1918: 128); the diagnostic features are: antennal scape dorsally black, post-antennal tubercles with yellow mark, tegulae with yellow mark, petiolus usually black, tergites with broad bands, sternites with bands or lateral spots.

Variation. — The petiolus and scapes are completely yellow in two males from Manus, which also have the legs nearly entirely yellow; one of these also had a pair of spots at the apex of the dorsal propodeal enclosure. The vertex is extremely swollen in four females from Normanby Island; the coloration is very rich in these specimens, including additional spots

laterally on the pronotum, on the hypo-epimeral area, and sometimes laterally on the mesoscutum.

Material examined. — Admiralty Islands. — 2 ♀, Manus, Lorengau, 17 and 19 June 1962, 2 ♀, Lavongai, Banatang, 19 and 23 March 1962, all Noona Dan Exp. (UZM).

New Britain. — 1 ♂, Rabaul, 1933, J. L. Froggatt (BMNH).

New Ireland. — 1 ♀, Kandan, 25 Dec. 1959, W. W. Brandt (BPBM); 1 ♂, Lemkamin, 16 April 1962, Noona Dan Exp. (UZM).

Normanby Island. — 4 ♀, Wakaiuna, Sewa Bay, 1—8 Jan. 1957, W. W. Brandt (BPBM, RMNH).

New Guinea. — transitional specimens, see under *S. f. bruinjuii*.

Solomon Islands. — 1 ♀, Small Gela, Balaga, 12—31 Dec. 1963, M. J. A. de Korter, 1 ♀, Guadalcanal, Honiara, Nov. 1967 (both ZMA); 1 ♀, Iles Salom, 1914, E. André (MNHN); 2 ♀, Malaita, Dala, 50 m, 6—8 June 1964, J. & M. Sedlacek (BPBM); 1 ♀, Isabel, Rasa, 11 Dec. 1964, M. McQuillan, 5 ♀ 3 ♂, Guadalcanal, Kukum, 7 Dec. 1961, M. Greenslade, 1 ♀, Bougainville, Oct. 1960, R. W. Paine (all BMNH); 1 ♀, Tulagi, jungle, collecting mud, 16 Dec. 1934, 1 ♀, Tulagi, Sasapi cutting, 25 Dec. 1934, 1 ♀, Sevo Isl., Reko, 23 Feb. 1934, all H. T. Pagden (RMNH); 1 ♀, Bougainville, Kieta, 26 Nov. 1959, T. C. Maa (BPBM).

#### REFERENCES

Basil-Edwards, S., 1921. On the habits of a *Sceliphron* wasp (*S. deforme*). — *Journal of the Bombay Natural History Society* 28: 293—297, figs. 1, 2.

Beaumont, J. de, 1969. Beiträge zur Kenntnis der Fauna Afghanistans. Sphecidae, Hymenoptera. — *Casopis Moravského Musea, Brno* 54 (suppl.): 385—406, 2 figs.

Bingham, C. T., 1897. The fauna of British India. Hymenoptera 1: i—xiii + 1—579. — Taylor and Francis, London.

Bohart, R. M., & A. S. Menke, 1976. Sphecoid wasps of the world, a generic revision: i—ix + 1—695, figs. 1—190. — University of California Press, Berkeley.

Cameron, P., 1899. Description of a new genus and some new species of fossorial Hymenoptera from the Oriental Zoological Region. — *Annals and Magazine of Natural History* (7)4: 52—69.

Cameron, P., 1900. Descriptions of new genera and new species from the Oriental Zoological Region. — *Annals and Magazine of Natural History* (7)5: 17—41.

Cameron, P., 1906. Hymenoptera of the Dutch Expedition to New Guinea in 1904 and 1905. Part I. Thynnidae, Scoliidæ, Pompilidae, Sphegidae and Vespidae. — *Tijdschrift voor Entomologie* 49: 215—233.

Dalla Torre, C. G. de, 1897. *Catalogus Hymenopterorum hucusque descriptorum systematicus et synonymicus* 8, Fossiores: i—viii + 1—749. — G. Engelmann, Lipsiae.

Dutt, G. R., 1912. Life histories of Indian insects IV. — *Memoirs of the Department of Agriculture in India* 4: 183—267, pls. 1—4.

Eady, R. D., 1968. Some illustrations of microsculpture in the Hymenoptera. — *Proceedings of the Royal Entomological Society of London* (A) 43 (4—6): 66—72, figs. 1—31.

Field, F., 1918. Habits of the Mason-Wasp. — *Journal of the Bombay Natural History Society* 23: 378—379.

Gussakovskij, V. V., 1928. Sphecidarum Species novae. — *Trudy Zoologicheskogo Instituta, Akademiya Nauk SSSR, Leningrad* 4: 3—19.

Gussakovskij, V. V., 1933. Sphecidae et Psammocharidae a cl. N. Zarudnyi in Persia orientali collectae. — *Travaux de l'Institut Zoologique de l'Académie des Sciences de l'URSS* 1: 269—304.

Gussakovskij, V. V., 1936. Schwedisch-chinesische wissenschaftliche Expedition nach den nordwestlichen Provinzen Chinas, Insecten, 41. Hymenoptera, 6. Sphegidae. — *Arkiv för Zoologi* (27A) (21): 1—15, figs. 1—6.

Iwata, K., 1939. Habits of some solitary wasps in Formosa. IV. — *Transactions of the Natural History Society of Formosa* 29: 161—178, 3 figs.

Kohl, F. F., 1918. Die Hautflüglergruppe Sphecinae IV. Die natürliche Gattung *Sceliphron* Klug (*Pelopoeus* Latr.). — *Annalen des Naturhistorischen Museums in Wien* 32: 1—171, figs. 1—82.

Lepelletier de Saint Fargeau, A., 1845. *Histoire naturelle des insectes, Hyménoptères* 3: 1—644. — Roret, Paris.

Maindron, M., 1878. Notes pour servir à l'histoire des Hyménoptères de l'Archipel Indien et de la Nouvelle-Guinée. I. Observations sur quelques Sphegiens (G. *Pelopaeus*) de l'Archipel Indien. — *Annales de la Société Entomologique de France* (5)8: 385—398, pl. 9.

Michener, C. D., 1944. Comparative external morphology, phylogeny and a reclassification of the bees (Hymenoptera). — *Bulletin of the American Museum of Natural History* 82: 151—326, figs. 1—246, diagrams 1—13.

Mocsary, A., 1883. *Hymenoptera nova europaea et exotica*. — *Ertekezések a Természettudományok Köreből* 13: 1—72.

Morawitz, F., 1888. *Hymenoptera aculeata nova*. — *Trudy Russkago Entomologicheskago Obshchestva* 22: 271.

Rohwer, S. A., 1921. The Philippine wasps of the subfamily Sphecinae. — *Philippine Journal of Science* 19: 665—676.

- Smith, F., 1856. Catalogue of the Hymenopterous insects in the collection of the British Museum, iv, Sphecidae, Larridae and Crabronidae: 207—497. — London.
- Smith, F., 1858. Catalogue of the Hymenopterous insects collected at Sarawak, Borneo; Mt. Ophir, Malacca; and at Singapore, by A. R. Wallace. — Journal of the Proceedings of the Linnean Society of London, Zoology 2: 42—130.
- Smith, F., 1859. Catalogue of the Hymenopterous insects collected at Celebes by Mr. A. R. Wallace. — Journal of the Proceedings of the Linnean Society of London, Zoology 3: 4—27.
- Smith, F., 1861. Descriptions of new species of Hymenopterous Insects collected by Mr. A. R. Wallace in the Islands of Batchian, Kaisaa, Amboyna, Gilolo and at Dory in New Guinea. — Journal of the Proceedings of the Linnean Society of London, Zoology 5: 93—143, pl. 1.
- Smith, F., 1863. Catalogue of the Hymenopterous Insects collected by Mr. A. R. Wallace in the Islands of Mysol, Ceram, Waigiou, Bouru and Timor. — Journal of the Proceedings of the Linnean Society of London, Zoology 7: 6—48.
- Smith, F., 1870. Descriptions of some new species of Apidae and Vespidae collected by Mr. Horn. — Transactions of the Zoological Society of London 7: 161—196, pls. 19—22.
- Strand, E., 1914. Ueber das Nest von *Sceliphron deformis* Sm. — Archiv für Naturgeschichte 80A (10): 116—117.
- Strand, E., 1915. Ueber einige orientalische und paläarktische Crabroniden der Gattungen *Sphex*, *Sceliphron* und *Ammophila* im Deutschen Entomologischen Museum. — Archiv für Naturgeschichte 81A(5): 88—97.
- Tsuneki, K., 1964. Some wasps collected by Dr T. Shirôzu in Kyushu. — The Life Study, Fukui 8: 10.
- Tsuneki, K., 1971. Studies on the Formosan Sphecidae (IX). A supplement to the subfamily Sphecinae (Hym.). — Etizenia 53: 1—7, figs. 1—14.
- Tsuneki, K., 1972. On some species of the Japanese Sphecidae (Hym.), notes and descriptions. — Etizenia 59: 1—20.
- Tsuneki, K., & K. Shimoyama, 1963. Sphecidae and Chrysididae collected in the district of Towada, Japan. — The Life Study, Fukui 12: 48—50.
- Turner, R. E., 1912. Notes on fossorial Hymenoptera, VI, on the species collected in New Guinea by the expedition of the British Ornithologists Union. — Annals and Magazine of Natural History (8)9: 194—202.
- Turner, R. E., 1917. On a collection of Sphecoidea sent by the Agricultural Research Institute, Pusa, Bihar. — Memoirs of the Department of Agriculture in India, Entomological Series 5: 173—205.
- Uchida, Y., 1925. A list of known species of the Korean Hymenoptera which I collected in 1922, and their geographical distribution. — Insect World 29: 328—337, 366—373.
- Vecht, J. van der, 1957. The Sphecoidea of the Lesser Sunda Islands (Hym.) I, Sphecinae. — Verhandlungen der Naturforschenden Gesellschaft in Basel 68: 358—372.
- Vecht, J. van der, 1961. Ueber Taxonomie und Evolution der Grabwespengattung *Sceliphron* Klug. — Verhandlungen XI. Internationaler Kongress für Entomologie, Wien 1: 251—256, figs. 1, 2.
- Vecht, J. van der, 1984. Die Orientalische Mauerwespe *Sceliphron curvatum* (Smith, 1870) in der Steiermark, Österreich. — Entomofauna 5: 213—219, figs. 1—5.
- Vecht, J. van der, & F. M. A. van Breugel, 1968. Revision of the nominate subgenus *Sceliphron* Latreille (recte: Klug) (Hymenoptera, Sphecidae) (Studies on the Sceliphronini, part I). — Tijdschrift voor Entomologie 111: 185—255, figs. 1—27.
- Wiley, E. O., 1981. Phylogenetics, the theory and practice of phylogenetic systematics: i—xv + 1—439. — New York, etc.
- Williams, F. X., 1919. Philippine Wasp Studies. — Proceedings, Hawaiian Sugar Planters' Association Experiment Station, Entomology 14: 1—186.
- Yasumatsu, K., 1942. Hymenoptera aculeata collected by Mr. K. Tsuneki in North China and inner Mongolia. I. Sphecoidea. 1. List of species. — Mushi 14: 103—104.



## INDEX

<i>affinis</i> (Maindron) .....	254	<i>kalshoveni</i> ssp. n. ....	249
<i>atripes</i> (F. Morawitz).....	240	<i>koreanum</i> Uchida .....	240
<i>bicinctum</i> Van der Vecht .....	249	<i>laticinctum</i> ssp. n.....	252
<i>bruinjnii</i> (Maindron).....	256	<i>lineatipes</i> Cameron.....	234
<i>bruynii</i> Cameron.....	256	<i>mocsaryi</i> Dalla Torre .....	254
<i>coromandelicum</i> (Lepeletier).....	243	<i>murarium</i> (Smith) .....	254
<i>curvatum</i> (Smith) .....	228	<i>nipponicum</i> Tsuneki .....	240
<i>deforme</i> (Smith) .....	230, 236	<i>ocellare</i> Kohl .....	258
<i>fallax</i> Kohl .....	256	<i>papuanum</i> Cameron.....	258
<i>femorale</i> ssp. n. ....	236	<i>pulchellum</i> Gussakovskij.....	228
<i>fervens</i> (Smith).....	242	<i>rectum</i> Kohl .....	228
<i>flavofasciatum</i> (Smith) .....	249	<i>rufipes</i> (Mocsary) .....	254
<i>formosum</i> (Smith) .....	255, 258	<i>rufopictum</i> (Smith).....	247, 249
<i>funestum</i> Kohl .....	226	<i>shestakovi</i> Gussakovskij.....	224
<i>japonicum</i> .....	240	<i>taiwanum</i> Tsuneki .....	238
		<i>tibiale</i> Cameron .....	234
		<i>unifasciatum</i> (Smith) .....	254















QL  
461  
T568  
Ent.

# TIJDSCHRIFT VOOR ENTOMOLOGIE

UITGEGEVEN DOOR

DE NEDERLANDSE ENTOMOLOGISCHE VERENIGING



## INHOUD

M. A. LIEFTINCK. — New and little known Platynemididae and Coenagrionidae from New Guinea and the Solomon Islands (Odonata), pp. 263—291, figs. 1—43.



# NEW AND LITTLE KNOWN PLATYCNEMIDIDAE AND COENAGRIONIDAE FROM NEW GUINEA AND THE SOLOMON ISLANDS (ODONATA)

by

M.A. LIEFTINCK †

With notes added by J. van Tol

*Rijksmuseum van Natuurlijke Historie, Leiden, The Netherlands*



## ABSTRACT

Five new species of Platycnemididae (Odonata), viz., *Rhyacocnemis prothoracica*, *Salomocnemis* gen. nov. *gerdae*, *Lieftinckia malaitae*, *L. isabellae* and *L. ramosa*, and four new species of the genus *Teinobasis* (Coenagrionidae), viz., *T. simulans*, *T. obtusilingua*, *T. chionopleura* and *T. imitans*, are described. *Papuagrion gurneyi* Lieftinck and *Teinobasis emarginata* Lieftinck are synonymized with *Teinobasis aluensis* Campion. Besides several other species of these families from the Solomon islands are discussed.

This posthumous publication concludes the scientific odonatological studies of Dr M. A. Lieftinck.

## [INTRODUCTION]

by J. van Tol

After the death of Maurits Anne Lieftinck on April 12th, 1985, most of his scientific material was donated to the Rijksmuseum van Natuurlijke Historie (Leiden). I have thought it one of my first tasks to investigate whether the manuscripts that Dr Lieftinck had at hand, could be prepared for publication. During my last visit to him in February, 1985, he showed me drawings and manuscripts in preparation. One large manuscript on the genus *Procordulia* and allied genera, for which many drawings were already prepared, is not available for publication; the second manuscript has resulted in the present paper.

The manuscript appeared to be almost complete, and thus suitable for publication. The drawings and photographs were all mounted on cardboard, and numbered. The descriptions of all but one species were available, but a general introduction, an introduction to the Platycnemididae and concluding remarks were lacking or not in a form ready for publication. I have added the minimum amount of text, restricting myself to additions that were needed to publish a consistent paper, viz., a title, an abstract, an introduction, a list of species included, a few titles of chapters (i.e. names of genera), the refer-

ences in the next to the figures, the captions of the figures, and the references. No serious problems were met with this work. The number of scientific papers in this field is rather limited, so that I could easily find the works referred to. The captions to the figures were prepared from notes made in pencil with the drawings, as well as from the text. Since the description of the specimens from the Thomas W. Donnelly collection, numbered "72 × 040", was lacking, I have left out the preliminary new genus and species name for this taxon, which is closely related to *Torrenticnemis*. The figures, which were already mounted by Dr Lieftinck, are, however, included. The names of chapters added by me are indicated in square brackets.

I should like to emphasize explicitly here, that Dr Lieftinck should be considered the author of all new names introduced in this paper.

## [ACKNOWLEDGEMENTS]

The cooperation of the curators of the Odonata departments of the following institutions is gratefully acknowledged (the abbreviations used for the collections are given in brackets): Bernice P. Bishop Museum, Honolulu (BISH), British Museum (Natural History), London (BM), Muséum National d'Histoire Naturelle, Paris (MP) and United States National Museum, Washington (USNM).



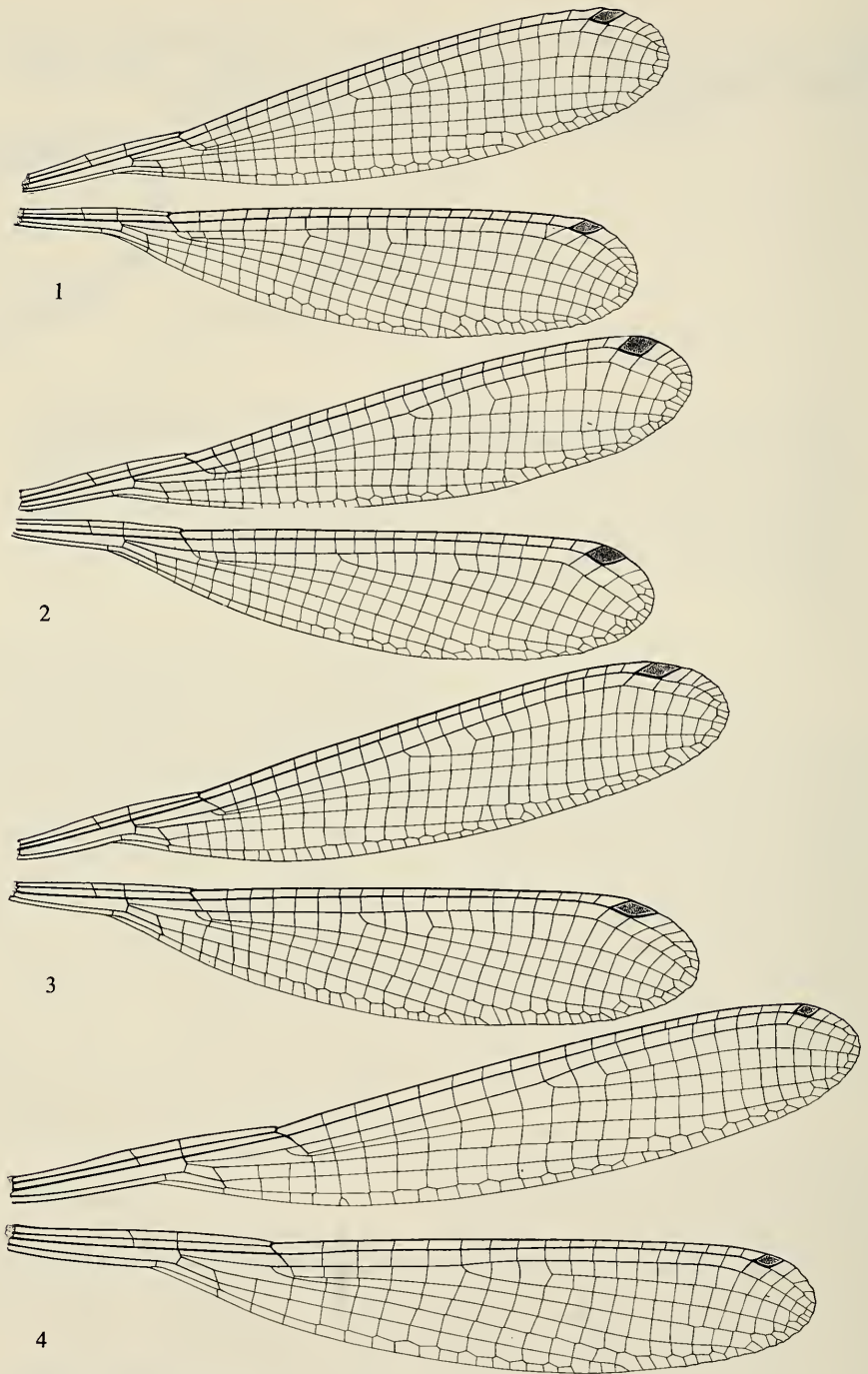

Figs. 1—4. Wings of Platycnemididae. — 1, *Idiocnemis obliterata* Liefstinck, 1932; 2, *Paramecocnemis erythro-stigma* Liefstinck, 1932; 3, *Lochmaeocnemis malacodora* Liefstinck, 1949; 4, *Torrenticnemis filicornis* Liefstinck, 1949.

The Rijksmuseum van Natuurlijke Historie, Leiden, is abbreviated as ML.

Special thanks are due to Dr Thomas W. Donnelly (Binghamton, N.Y.) for making specimens from his own collection available for study.

[LIST OF SPECIES INCLUDED]

Platycnemididae

Genus *Rhyacocnemis* Lieftinck, 1956  
*R. prothoracica* spec. nov.

Genus *Salomocnemis* gen. nov.  
*S. gerdae* spec. nov.

Genus *Lieftinckia* Kimmins, 1957  
*L. salomonis* Kimmins, 1957  
*L. lairdi* Lieftinck, 1963  
*L. malaitae* spec. nov.  
*L. kimminsi* Lieftinck, 1963  
*L. isabellae* spec. nov.  
*L. ramosa* spec. nov.  
*Lieftinckia* spec. indet. 1  
*Lieftinckia* spec. indet. 2

Coenagrionidae

Genus *Teinobasis* Kirby, 1890  
*T. aluensis* Campion, 1924  
*T. simulans* spec. nov.  
*T. obtusilingua* spec. nov.  
*T. chionopleura* spec. nov.  
*T. imitans* spec. nov.  
*T. bradleyi* Kimmins, 1957

PLATYCNEMIDIDAE

*Rhyacocnemis* Lieftinck, 1956

*Rhyacocnemis prothoracica* spec. nov.  
(figs. 5, 8)

Material. — NE. New Guinea: 1 ♂ (adult, holotype), Morobe Dist., stream at Gurakor, Wau Rd., 500 m, 25.x.1972, nr. 72X044, Thomas W. Donnelly leg., in coll. ML.

Male (adult, holotype). — Smaller than *R. sufficiens* Lieftinck, 1956. Head short and broad, width across eyes only 4.0 mm. Labium bright creamy yellow, median lobe with short V-shaped emargination about 1/5 as deep as midlength of lobe itself, its apical lobes somewhat convex exteriorly, obtusely rounded off, tips, as also the outer border of palpi, fringed

with ferruginous bristles. Labrum and clypeus broad and prominent as in *sufficiens*, well visible from above; labrum convex and widest anteriorly, its surface smooth and rather shiny, deep black; anteclypeus pale at middle, postclypeus with pair of bright yellow transverse spots, one each side, which taper inward leaving a thick T-shaped black mark occupying most of the surface. Frons in front and whole genal area taken up by a sharply defined chrome yellow bar connecting the eyes, which extends upward to almost reaching the antennal sockets; remainder of head above and underneath deep coal black with no other pale marks or pruinescent areas than a pair of large, isolated, pear-shaped sky-blue postocular spots pointing inward. Antennae long (about 2.5 mm), black; scape cylindrical, short and thick, only little longer than its diameter at apex, pedicel slender, slightly clubbed, about 7–8 times as long as its apical width, third segment much thinner but of equal length, the distalia long and thread-like.

Prothorax markedly dissimilar to that of *R. sufficiens*; anterior lobe long, rather depressed and lacking a distinctly swollen anterior rim, its dark surface indistinctly mottled with ferruginous specks and with a pale margin; pronotal tubercles strongly raised, forming a pair of robust slightly diverging cone-shaped and bluntly pointed processes whose surface is dull and coarsely wrinkled; these pyramidal bosses are about equal in height to the smooth propleurae and directed obliquely upward and backward; posteriorly, they are feebly ridged on either side, enclosing a more flattened forward slanting posterior face; immediately behind each of them arises a small and thin transverse plate, situated on a much lower level; posterior lobe broad and collar-shaped, about equal at midlength to the anterior lobe by lying flatly down, its side angles triangular, slightly projecting and a little downbent. Colour of whole dorsal surface of prothorax lustreless dark brown on coarsely wrinkled ground, all lateral parts remaining smooth and contrastingly coloured a bright greenish yellow.

Mesothorax with a complete, almost parallel-sided, dull bronze-black middorsal band occupying the inner halves of mesepisterna, the middorsal carina and ante-alar triangles being also black; outer halves of mesepisterna lighter, forming a dark ferruginous brown juxtahumeral band equal in width to the black middorsal one, this coloured area acquiring a much lighter tint upon lower 1/4 of mesepimera in the form of an

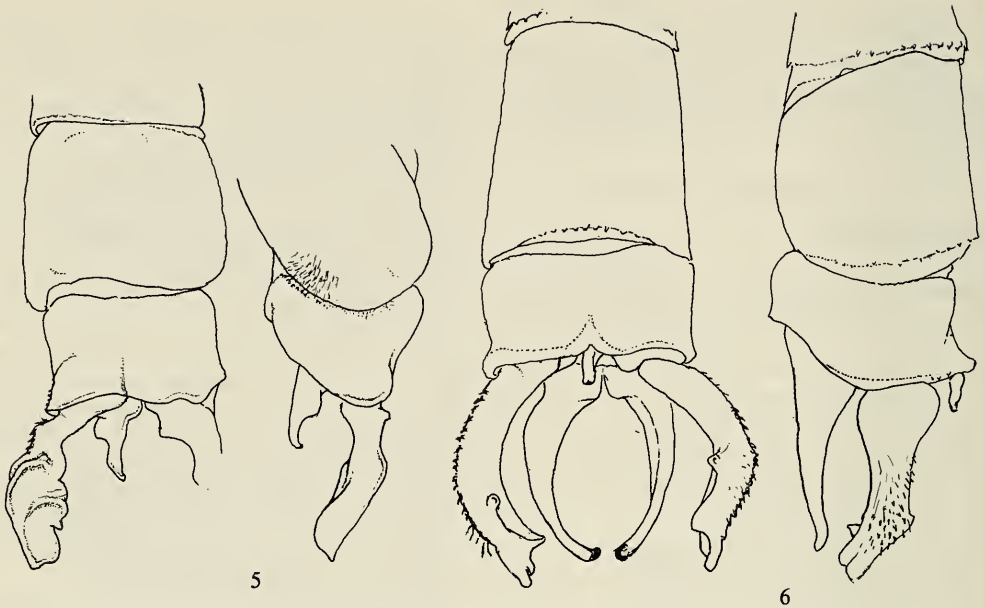

Figs. 5—6. Male appendages of Platycnemididae in dorsal and left lateral view. — 5, *Rhyacocnemis prothoracica* spec. nov.; 6, Unnamed species, "72×040" collection of Donnelly.

elongate patch of bright chrome which is continued ventrad upon the mesostigmal laminae. A black line, broadening at lower end to occupy most of the mesinfraepisternites as well, accentuates the humeral suture. Sides, as far down and just including the metaspiracle, bright chrome intermingled with light green; behind this, an almost equally broad but very irregular band of rusty dark brown runs over the second suture, expanding ventrad to cover also most of the metinfraepisternites; rest of metepimeron distinctly light blue, the lateroventral carina and whole ventral surface of thorax, pale yellow; poststernal plate almost bare, but provided upon its middle with a compact patch of many longish, dark, stiff bristles placed upon a distinctly swollen part of the sclerite, the setae making up this paintbrush-like tuft being directed straight back though remaining well visible in profile view.

Legs thin and slender, hind femur reaching back to a little beyond halfway length of first abdominal segment; femoral bristles 11—12 each side, longest on hinder pair, almost three times the interspaces but decreasing in length toward base, 8—9 on mid and fore femora; tibial bristles longer, 7—8 in outer row of hinder pair; tarsi slender, the claws with small but

acute subapical inferior tooth. Colour of all coxae and trochanters blue-green, outer faces of all femora with a thick black stripe broadening gradually toward end including the knees, inner faces bright chrome darkening toward apex; all tibiae and tarsi black but claws yellowish.

Wings (fig. 8), narrower with more pointed tips than in both *Idiocnemis* and *Paramecocnemis* (figs. 1, 2), shape and venation very similar to *R. sufficiens* (fig. 7), the undulations of post-pterostigmal border slightly more pronounced than in the latter but not less so than in *Idiocnemis*; neuration black. Pterostigma oblique, a trifle longer than high, dark brown heavily framed in black. Wing bases with all axillary sclerites as well as the meso- and metanota strikingly coloured a brilliant sky-blue.

Abdomen (end segments fractured), very slim and slender but not unusually drawn out and lacking conspicuous hair tufts on any of the tergites such as seen in both species of male *Paramecocnemis*. Structural peculiarities are (1), postero-lateral edge of tergite 2 produced backward, ending in a short triangular lobe (instead of normally cylindrical and parallel-sided in *sufficiens*), its lower border sparsely beset with golden yellow setae; (2), Antero-lateral edge of tergite 3 with a short, nipple-shaped protuber-



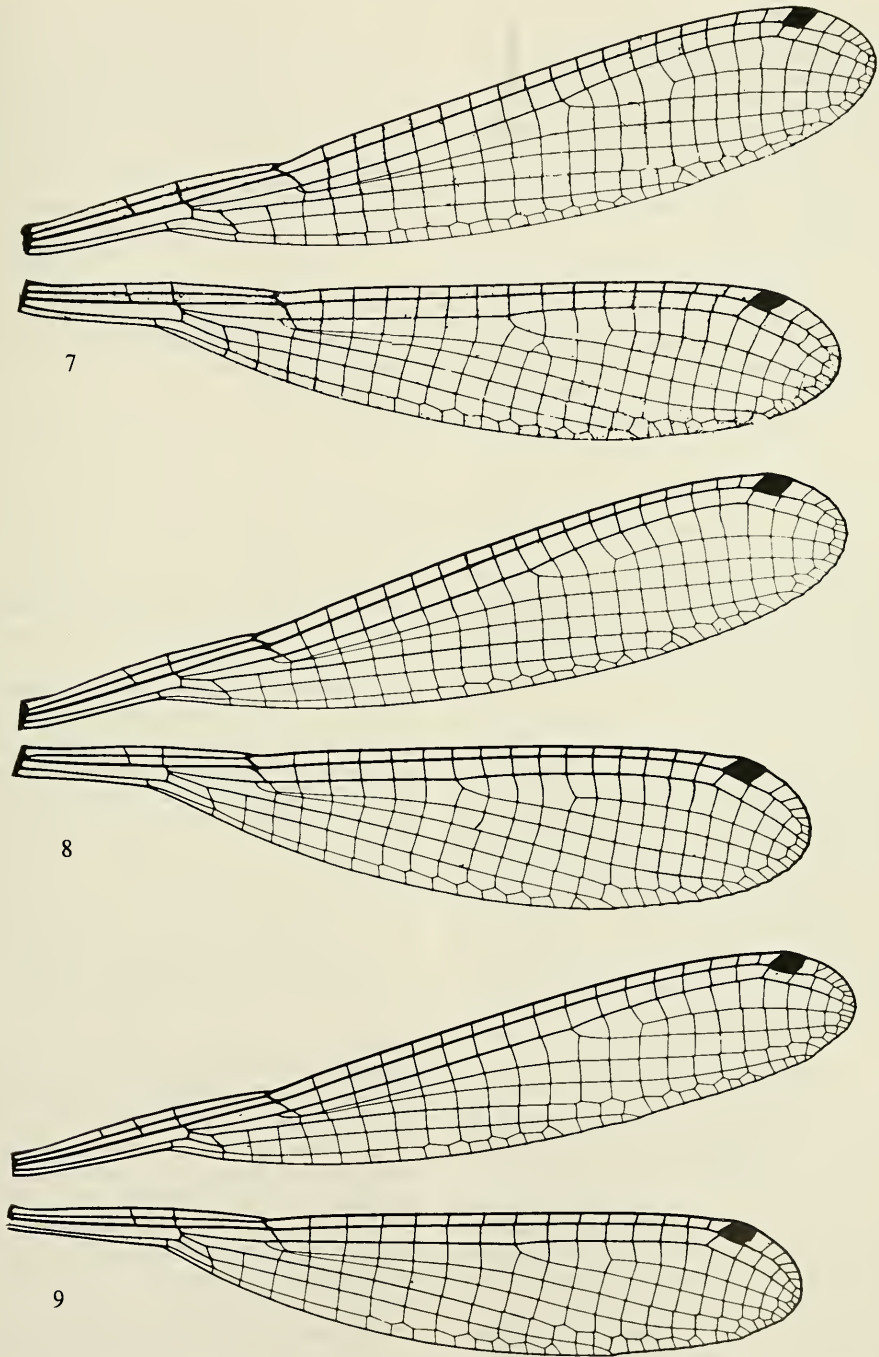

Figs. 7—9. Wings of Platycnemididae. — 7, *Rhyacocnemis sufficiens* Lieftinck, 1956; 8, *Rhyacocnemis prothoracica* spec. nov.; 9, Unnamed species, "72×40" in Donnelly collection.

ance directed laterad (this tergite normal in *sufficiens*); intermediate segments thin and needle-like, but from end of 7 on gradually expanding in both dimensions, 8 about one and one-third times longer than 9, the latter squarish and parallel-sided, 10 short and broad. Almost wholly black; tergites 1 and 2 conspicuously marked with sky-blue and bright ochreous: distal half of 1 blue, finely interrupted by black in the median line, this stalk attached to a narrow black apical ring; 2 on either side with complete, thick, bright chrome lateral bar occupying lower portion of tergite; next segments, inclusive of the anal appendages, apparently all black (tergites 8 and 9 possibly discoloured and partly blue in life?), save merest traces of obscurely coloured basal annules and a yellow line bordering ventral margin of tergites 3—7. Directly from below mid-apical border of tergite 10 projects a slender, rod-like cylindrical process whose apex is subtruncated and a little incised.

Anal appendages as in fig. 5; superior pair about equal in length to the subquadrangular 9th segment, at first outcurved and bluntly toothed on the inside near base, then broadening, bent inward and somewhat flattened, strongly transversely ridged on uneven ground, inner border in dorsal view irregularly sculptured and toothed, outer faces of basal portion of each beset with short and strong spike-like denticles interspersed with longish hairs (only partly shown in dorsal view and omitted inside view sketch). Inferior appendages well developed but attaining only half the length of superior pair, basal portion of each broad and rather swollen, then rather suddenly narrowing and somewhat curved toward each other, gently tapering to slightly upcurved tips.

#### *Salomocnemis* gen. nov.

Stature of *Lieftinckia*, but with a broader head and more bulging eyes. Labium similar, the median emargination equally small but less narrow, the limbs of the U distinctly diverging instead of subparallel. Shape of mouth-parts and face much as in *Lieftinckia salomonis* (the type-species), but all parts comparatively a little broader. Anteclypeus forming a right angle with the postclypeus, the latter distinctly carinate anteriorly. Frons obtuse-angulate anteriorly with well-pronounced though rounded, transverse ridge, instead of gently sloping down and rather flattened in *Lieftinckia*; frontoclypeal suture broad, impressed, rectangular, the sulcus be-

tween antennal sockets likewise distinctly impressed. Inner orbital line straight (not convex), strongly converging anterad on dorsal as well as on ventral surface of head (parallel-sided ventrally in *Lieftinckia*). Antennal sockets but little raised but distinctly swollen; scape only slightly longer than its socket, thick, cylindrical, little more than twice as long as broad; pedicel more slender and rather clubbed apically, subequal in length to scape; segment 3 thinner and about one-fourth shorter than pedicel, remaining segments about equal in length to scape and pedicel united. Vertex small, raised, ocelli in equilateral triangle. Occipital ridge subacute.

Prothorax not modified, pronotal tubercles raised, conical; posterior lobe broad, surface convex, rather dome-shaped, side-angles rounded off in both sexes. Legs much shorter and less slender than in *Lieftinckia*; hind femur not nearly attaining apex of 2nd abdominal segment; armature as in the allied genus, but all femoral and tibial bristles comparatively a little shorter; tarsal claws with distinct subapical inferior tooth only little shorter than the claw itself.

Wings less abruptly petiolated, more evenly broadened and with more open neuration than in *Lieftinckia*. Nodus situated more distad, approximately one-third of the distance from base to apex. Arculus at Ax<sub>2</sub>; Ac placed distal to Ax<sub>1</sub>, instead of far proximal to that level in *Lieftinckia*; petiolation of the wing as in that genus ending at a point where Ab meets the wind border, but Ab and Ac coincident at margin instead of far apart, Ab occasionally terminating slightly proximal to Ac, almost at level of Ax<sub>1</sub>. Rs at or slightly distal to subnodus, M<sub>3</sub> well before that level, the distance separating them at origin shorter in fore wings than in hind wings. Two postquadrangular antenodal cells. Quadrilateral hardly broadened distally, costal side much longer than distal side, especially in hind wing. Medio-anal link entire, or almost so. Wing border of whole apex posterior to pterostigma, back to termination of Cu<sub>1</sub>, slightly but distinctly undulated (most marked on hind wing). A single row of cells between C and R<sub>1</sub> beyond pterostigma. Pterostigma rather swollen, almost square, covering one underlying cell.

Abdomen slender, basal and terminal segments moderately inflated. Proportionate lengths of segments as in *Lieftinckia*. Colour pattern much as in that genus. Vesica spermalis of ♂ penile organ not prominent, suboval, thin and plate-shaped in profile view, membranous

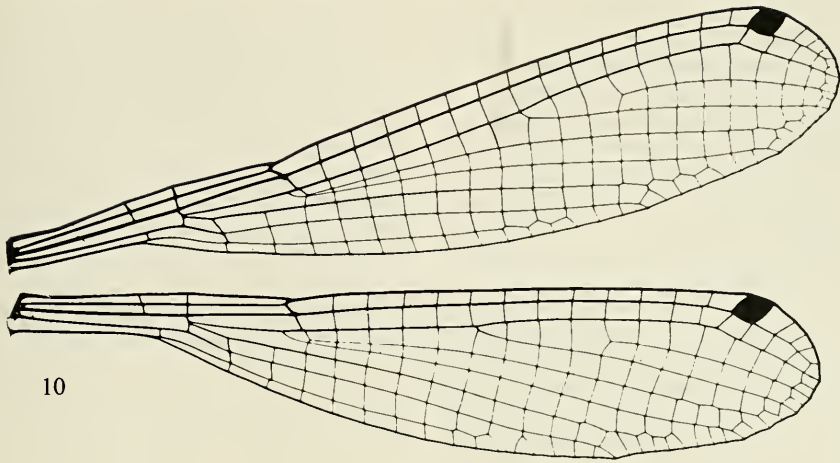

10

Fig. 10. Wings of *Salomocnemis gerdae* spec. nov. (Guadalcanal).

in the centre, but with strongly sclerotised lateral rims; ligula (penis) shaped as in fig. 15; no shaft spines. Male anal appendages of rather simple structure, resembling *L. salomonis*. Eighth abdominal sternite of female simple, without any indication of an apical spine; genital organs normal, valves surpassing tenth segment and tuberculum anale for about the same length as the former, lower margin of outer valves finely denticulate; cerci short and blunt, flattened dorsoventrally.

Type-species: *Salomocnemis gerdae* spec. nov.

Habitat: Solomon Is. (Guadalcanal).

***Salomocnemis gerdae* spec. nov.**  
(figs. 10, 14—16)

Material. — Solomon Is.: 2 ♂ 1 ♀ (1 ♂ subadult), one pair of juveniles, Guadalcanal I., Komugelea, 1200 ft., "in forest", 22.ix.1965, R. Slooff and Gerda Stanny Slooff-de Vries (all ML).

Male (subadult, holotype). — Head with labium palest yellow, mentum and centre of median lobe semitransparent, colourless. Mandible-bases dark yellow-green, the teeth black. Labrum, clypeus, genal area and frons, dark olive-green, rather shiny; all the rest of dorsal surface of head, including the antennae, similarly coloured but dull, sparsely marked with light brown, as follows: a minute central spot in the depth of ante-ocellar depression, basal half of antennal pedicel, a crescentic spot to the inside of each lateral ocellus, and a vestigial spot upon

middle of occipital ridge; a curved black line extends inward on either side of middle upper orbital margin as far as outer end of occipital ridge, the upper part of the postocular area behind this line being olive-green, the lower portion dark brown fading to dirty yellowish underneath.

Prothorax, inclusive of anterior and posterior lobes, dull orange, growing paler and intermingled with light green laterally; pronotal tubercles little elevated, rounded; posterior lobe depressed, at least four times broader than long, surface slightly convex and undulated, its posterior border a little upturned, almost straight, side-angles rounded. Synthorax orange, deepest in tint at the humeral suture but becoming lighter with admixture of pale green upon lower portions of epimera and infraepisterna; dorsum, to a little in advance of humeral suture, olive-green; mesoprescuta orange, with deep black speck on either side of the triangles, the latter also orange but with their borders deep black, as are the postero-dorsal edges of the metepimeron.

Legs with coxae and trochanters palest orange, for the rest light greenish to greyish yellow; apices of all femora and last tarsal segments, narrowly ringed with brown; all bristles and teeth of tarsal claws brown.

Wings hyaline, the open neuration black, only the petiole somewhat more palely veined. Whole margin of wing apex posterior to pterostigma with a number of small but distinct undulations, the posterior border of hind wing



moreover noticeably protruding at a point where  $M_3$  and  $Cu_1$  enter the margin. Fore wing with 14, hind wings with 12 Px of first series; Rs arises very slightly distal to subnodus,  $M_3$  well proximal to it;  $M_2$  at  $Px_7$  in fore wings, a little beyond  $Px_5$  in hind pair;  $M_{1a}$  three and four cells further distad, respectively. (In all fore wings and in four out of six hind wings, the anal bridge terminates even a little proximal to Ac, which in the female is placed under  $Ax_1$  instead of slightly distal to it).

Abdomen, ground colour yellowish, distal portions of tergites 3—7 marked indefinitely with brown, this colour progressively becoming more extensive and darker posteriorly; hind margins of 1—2 finely ringed with black and each with a dark middorsal line; basal 1/3 to 2/5 of 3—7 yellow, passing gradually to brown posteriorly, the apical rings deep black; 8 black, 9 brownish black mottled with yellow, dorsum of 10 entirely yellow, the sides greenish with a deep black streak alongside middle of posterior border.

Anal appendages (fig. 14), superior pair triangular, acutely pointed, inner faces of each rather flattened, the basal portions also triangular, directed obliquely mesad and ventrad, tapering to a blunt black-tipped process visible only in caudal view; inferior appendages also yellowish, rather longer, strongly hollowed out within, the apices of each incurved, squarely cut off and furnished with a row of five black denticles.

Female (juvenile). — N.B. Where not mentioned in the description of the male, most of the next details of structure also apply to that sex.

Resembles the male in most respects. Mouthparts in better condition than in the available males. U-shaped median emargination of labium elongate, about 1/5 total length of midlobe, the U itself parallel-sided; colour of whole structure as well as mandible-bases, palest chrome. Labrum porrect, slightly more than 1/2 times broader than long, widest at middle, its surface convex, smooth. Structure of all upper parts of head and antennae as described for the male, coloration a pale creamy yellow inclusive of the sockets and scape of antenna, the pedicel and third joint being grey-black, for the rest distalia again lighter. Postocular area cream, except its anterior suture finely deep black; occipital region gradually changing to brown.

Prothorax much as in male: surface smooth, pale ochreous almost throughout; anterior lobe broad, of the usual shape, subequal in width to

the posterior one but strongly swollen in side view, moderately raised, its front border thickened, straight-lined and subacute in dorsal view, but protuberant in side view, with pair of deep black transverse rims one each side; pronotum with three pairs of somewhat convex, roundish tubercles placed in the long axis, the outer pair largest, the innermost pair diverging anterad but fused together in the median line posteriorly, the outer tubercles covered with extremely minute, finely pointed tubercles; transverse sulcus separating them from posterior lobe moderately deep, surface irregular. Posterior lobe of prothorax quite simple, not at all modified, mid portion somewhat raised, bow-shaped in caudal view, the whole structure about 4—5 times broader than long, hind margin subacute, almost straight at middle in dorsal view, sides gently rounded, hardly downcurved.

Mesostigmal laminae small, subtriangular, yellow, each with a raised, deep black inner rim placed in the long axis, lateral parts triangularly tapered (fig. 16). All colour marks on dorsum of synthorax ill-defined, pale chrome with faint greenish hue: a pair of wedge-shaped antehumeral bands, widest below, tapering and bluntly pointed upward, on a pale ferruginous ground, this colour extending laterad to almost halfway metaspiracle; ante-alar triangles lighter but finely black-rimmed, as are also the dorsal ridges of mesopleurae, a speck at upper end of second suture, and the posterior borders of the metepimeron.

Legs throughout light greenish yellow, the femoral banding hardly indicated; all spines and bristles obscured; tarsal claws as described for the male; with small but distinct, sharply pointed dark inferior tooth very near the apex proper.

Wing neuration light brown, membrane hyaline. Venation, inclusive of the relative positions of Ac and origin of  $M_3$  — Rs as well as shape of pterostigma almost exactly as described for the male (fig. 10), but differing from the latter in that the wing tips are more bluntly rounded, the post-pterostigmal as well as the underlying cells being markedly higher, those of the latter being subquadrangular or even higher than long (instead of the reverse in two males). Also, the marginal undulations at wing tips and end of main veins, are distinctly more pronounced than in the opposite sex. Pterostigma dark grey, contrastingly framed in bright yellow.

Abdomen slender, of the usual shape, basal segments scarcely broadened, thereafter grad-

ually a little expanded toward the end (immature specimen!). Ground colour cream, marked indistinctly with brown: traces of that colour on middorsum and sides of tergite 2, whole 4/5 of 3, 2/5 of 4—6, almost distal half of 7, and most of 8 including the valves; 9—10 as well as the cerci and tuberculum, all yellow. Genital valves rather long, projecting beyond apex of abdomen, equal in length to lower margin of tergite 8; ventral border of valves only slightly convex in side view, apical 3/5 of each armed with a row of ca. 24—26 microscopical swollen tubercles gradually increasing in size toward apex, each of the most distal ones ending suddenly in a minute acuminate spine.

Measurements: ♂ abdomen + appendages 34.6 mm, hind wing 21.5 mm; ♀ abdomen (incl. valves) 33.1 mm, hind wing 21.4 mm.

### Lieftinckia Kimmins, 1957

#### Lieftinckia salomonis Kimmins

(fig. 17)

*Lieftinckia salomonis* Kimmins, 1957: 312—315, fig. 1 A—G (♂♀ struct.), ♂♀ Guadalcanal. — Lieftinck, 1963: 527—530, 541—542 (♂♀ incl. key), 531—533 (♂ larval struct.), pl. 26 fig. 1 (♂ wings), tfig. 1—12 (♂♀ imaginal char. & larval struct.), ♂♀ Guadalcanal.

Additional material. — Solomon Is.: 1 ♀ (juvenile) Guadalcanal I., Tenaligi River 25.ix.1965, "heavy forest", R. Slooff (ML); 1 ♂ (adult), Guadalcanal I., Gallego, 11.vii.1965, "hidden valley, 2nd grass clearing", Roy. Soc. Exped. Brit. Mus. 1966 (BM); 1 ♂ 2 ♀ (subadult), Guadalcanal, Gold Ridge, 22.iii.1955 (♂) and Tsarivonga river, same date (♀), E. S. Brown (BM).

Male. — The Gallego specimen from Guadalcanal is the first full-coloured male of the type-species of *Lieftinckia*. Like so many other platyneמידs, *salomonis* also passes through a series of colour phases before reaching maturity, the present case being a good example of this extraordinary variation. With its pale brown and cream-coloured body, the present male looks quite different from the immature insect. Labium obscurely red-brown, all the rest of the face vividly brick red as far upward as a little behind the ocellar triangle; thereafter the red changes abruptly to black in a line that runs from eye to eye, passing over the occipital crest, which itself is dark brown in the middle. Hind

portion of the postocular lobes and rear of the head, deep black except a triangular spot on the lower genal area. Dorsum of prothorax and upper part of its sides dull black, for the rest obscurely orange-red. Mesepisternites and antalar triangles black, almost lustreless, this colour passing beyond the humeral line for a short distance parallel to the suture but suddenly expands upward so as to occupy also the dorsal one-third of the mesepimeron. Sides and ventral surface of thorax bright chrome, only most of the infraepisternites rusty brown. Coxae and femora inclusive of the bristles, orange-red; outer faces of fore femora more obscured, knees also darkened; tibiae and tarsi reddish black.

Wing membrane suffused with grey-brown, pterostigma brownish black. Abdomen dark brown becoming black on the terminal segments; sides of 1 and those of 2 for the basal 2/3 part, ochreous; fairly distinct basal and subterminal spots of the same colour bordering the tergites laterally being also present on 3—6, these spots elongate and fused together on 7.

The three further Guadalcanal specimens (Tapenanje), are near topotypes collected in 1955. These were found unnamed in the British Museum collection years later than the examples of either sex discussed earlier by Kimmins (1957) and myself (1963).

I made the following brief colour note on the subadult male: "Head bright orange, dorsum of synthorax black, the sides and legs orange; abdomen obscured, the annules sharply defined, segm. 10 and anal appendages yellow".

#### Lieftinckia lairdi Lieftinck

*Lieftinckia lairdi* Lieftinck, 1963: 534—537, 542 (key ♂♀), pl. 26 fig. (♂ wings), tfig. 13—16 (♂ struct.), ♂♀ Guadalcanal.

*Lieftinckia* spec.? Kimmins, 1957: 315, ♀ Guadalcanal.

Additional material. — Solomon Is.: 1 ♂ (adult), Guadalcanal I., Sutakiki River, 23.iii.1955, E. S. Brown, no. 2605 BM 1957—201 (BM); 1 ♂ (subadult), Guadalcanal I., Nuhu, 26.x.1965, "slow flowing pool formed by seepage alongside river, by ford", Roy. Soc. Exped. Brit. Mus. 1966 (ex BM, ML).

Male (adult, Sutakiki river). — This is a near topotype, larger in size than the previously described immature specimens. The following details are noteworthy additions to the original description.



Prothorax shaped as in the immature insect but colours generally darker; posterior lobe more evenly bordered, showing no undulations such as seen in the juvenile males. Sides of synthorax red-brown, the meso- and metepimera predominantly light green. The subapical dark rings at the femora are broad but not sharply pronounced. Wings relatively shortly stalked, neuration likewise not differing from that originally described and photographed (loc. cit., 1963, pl. 26 fig. 2). Fore wing with 22—23, hinder pair with 20 Px of first series;  $M_3$  arises just before the subnodus, Rs half a cell beyond that level. The short, narrow and very oblique pterostigma approaches *salomonis* most closely in shape.

Abdominal tergites mainly blackish brown, but dorsal bands much less constricted and contrastive with the light ground colour, than in *malaitae* spec. nov., described hereafter.

Measurements: abdomen + appendages 40.5 mm, hind wing 28.0 mm.

So far only known from Guadalcanal.

**Lieftinckia malaitae** spec. nov.  
(fig. 12)

Structurally very similar to *L. lairdi*, but obviously specifically distinct from that species.

Material. — Solomon Is.: 2 ♂ 1 ♀ (semiadult), Malaita I., Dala, 50 m, 9—14.vi.1964, J. & M. Sedlacek (ex BISH, ML); 3 ♂ (2 ad., 1 subad.), Malaita I., Ngwaiu, 1500 ft., 10.x.1967, R. Slooff (holotype ♂ and 2 paratypes, ML).

Male (adult, Ngwaiu). — Antenna long, almost equal in length to inner orbital line when viewed from above; scape short and cylindrical, little longer than broad, pedicel thin and much slenderer (apparently a little varying in length: in one paratype fully three times longer than scape), both segments pale in colour; distalia darkened, about as long as first two segments united.

Head, thoracic sclerites and legs, all more uniformly coloured than in *lairdi*, of a delicate cinnamon to light brownish orange, deepest in shade on top of frons, the ocellar region and on the thorax above; otherwise unmarked save minute dark lines and specks at the median carina, dorsal margin of mesepimeron, the uppermost edges of the pleural parts, and at the lateroventral angle of metepimeron. Whole ventral surface of thorax as well as the coxae, trochanters and femora, throughout pale, the ex-

treme tips and much broader subapical rings of femora brown, the latter distinct though not sharply outlined; tibiae, tarsi and bristles slightly more obscured than the femora.

Shape and neuration of wings as shown in fig. 12, relatively narrow and elongated, more abruptly stalked than in *salomonis* and *lairdi*, the stalk also being longer than in the latter, while the pterostigma is slightly less oblique, higher and more nearly parallel-sided. Fore wing with 18—22, hind wing with 17—18 Px of first series.

Ground colour of abdomen light ochreous, but tergites 2—7 much more contrastingly marked with blackish brown than in any other species. Dorsal bands extending from base to apex, forming complete, fairly distinct marks, which toward the base of each tergite are rather pointed, leaving elongate yellow lateral spots, but distad are markedly constricted before becoming fused with well-defined black apical rings. Tergites 8—10 much obscured, only the sides usually broadly yellowish.

Anal appendages (not figured) yellow, the superiors darkened above, shaped much as in *lairdi*, but differing as follows: superior appendages triangular, rather inflated basally, as in *lairdi*, but more distinctly pointed apically; inferiors less strongly upcurved with the black tips sharply hooked inward and acuminate, instead of tapering gradually, as seen in *lairdi*. The robust interobasal spurs of the superior appendages are distinctly longer than in *lairdi* and wholly exposed in side view, at first directed straight ventrad, then gently curving cephalad; in caudal view these processes are directed toward one another, the apices meeting at their extreme tips, thus remaining uncrossed.

Female (subadult). — Resembles the male in most respects but differs in details of colouring and the better defined abdominal pattern. Mouth-parts pale yellow, the labrum mixed with light ochreous; face, the swollen antennal sockets, and an ill-defined broad area along inner orbits tending to palest green, the vertex surrounding the ocellar area and most of the occipital region behind it, dark cinnamon, this colour occupying most of the dorsal surface between the eyes posterior to the lateral ocelli. Antennae pale, shaped as in male, the long slender pedicel tipped with black. Ventral surface of head palest greenish yellow.

Pro- and synthorax light brownish yellow, rather darkened upon all upper parts: brown



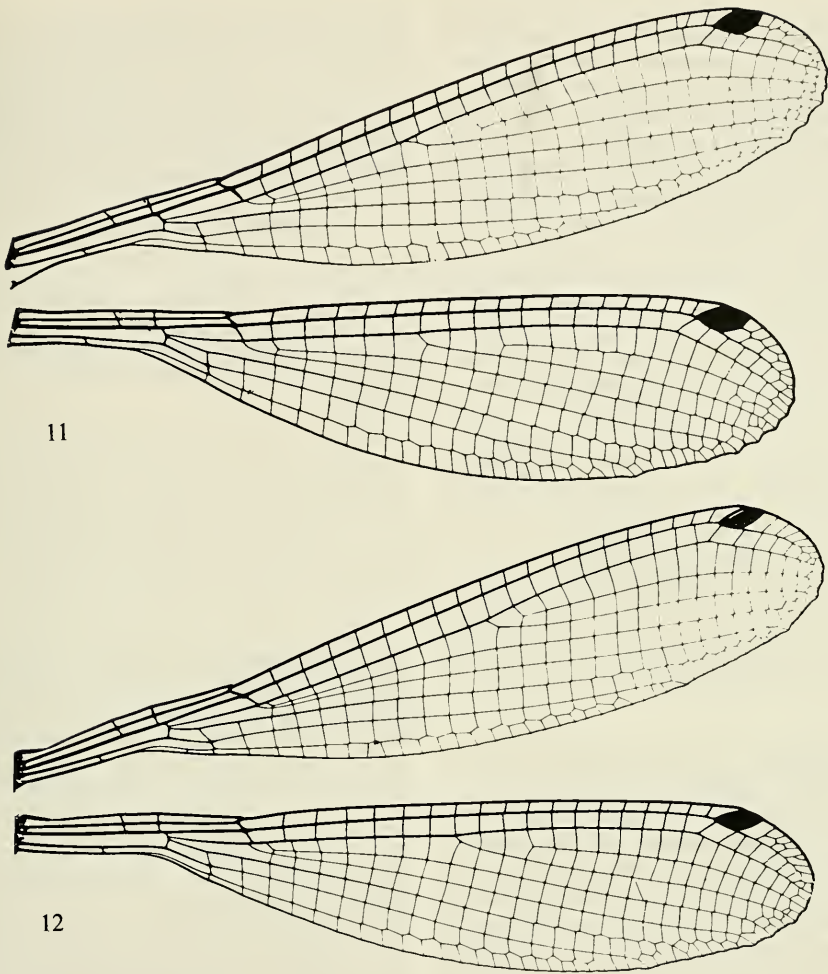

11

12

Figs. 11—12. Wings of *Lieftinckia* species (Platycnemididae). — 11, *L. isabellae* spec. nov. (Santa Isabel); 12, *L. malaitae* spec. nov. (Malaita).

becoming dirty orangish on the surface on either side of the humeral line, and still more diffusely so along the second suture, between these darkish areas is a band of pale yellowish green. Prothorax little modified, pronotal tubercles low, not at all prominent, their dorsal line in side view almost straight; anterior lobe raised, of the usual shape, its border simply convex; posterior lobe short and broad, shorter than the pronotum itself, slightly raised and almost straight-lined in dorsal aspect but hind border distinctly undulated with obtuse-angulate dorso-lateral edges, the little prominent lateral lobes small, narrowly rounded off.

Legs including bristles pale, femora ringed as in male, brownish.

Wings hyaline, the apical crenulations as distinct as in male. Fore wing with 19, hind wings with 17 Px of first series. Pterostigma shaped exactly as in the opposite sex, i.e. with sides more nearly parallel than in *lairdi*; colour pale grey-brown.

Abdomen slender but less so than in male, with cylindrical segments of almost even width, except the last ones very slightly expanded. Ground colour light ochreous, the dorso-lateral dark brown marks much more sharply defined, standing out more clearly than in male, as fol-

lows: tergite 1 only the raised posterior portion in front of the intersegmental halfring behind the transverse ridge, brown; terminal ring of 2 occupying slightly more than its apical one-third, this spot narrowly prolonged forward in the median line; dorsal marks of 3—7 more deeply constricted subapically than in male, pointing basad, becoming successively broader from before backward, the broad basal portions of light ground colour most conspicuous and largest on 2—4, subinterrupted before their fusion with the dark apical rings; brown and yellow areas of tergites 8—10 ill-defined, the yellow predominating. Valves not surpassing segment 10; cerci short, triangular and finely pointed, yellowish.

Measurements: ♂ abdomen + appendages 33.5—38.2 mm, hind wing 22.8—25.0 mm, the holotype male being the largest specimen; ♀ 32.5 mm and 24.0 mm, respectively.

**Lieftinckia kimminsi** Lieftinck  
(fig. 18)

*Lieftinckia kimminsi* Lieftinck, 1963: 537-541 (♂ ♀ inclus. key), pl. 26 fig. 3 (♂ wings), tfig. 17—18 (♂ struct.), ♂ ♀ Bougainville I.

No fresh material.

This species is easily distinguished from its congeners by a combination of characters. It is chiefly remarkable for the well-defined bright blue head and thorax markings, and also by having a relatively large head (width across eyes and total body length in the ratio 10.2:100), which gives the insect a "facies" reminiscent of certain species of *Coelliccia*. Shape of wings and venation similar to *lairdi*, but wings of the latter are slightly narrower and less abruptly petiolated (cf. Lieftinck, 1963: pl. 26, figs. 2 and 3). The pterostigma is rather like that of *ramosa* (fig. 13), distinctly less oblique, more regularly lozenge-shaped, than in *lairdi*. In both *lairdi* and *kimminsi* the posterior margin of the wing tips is strongly undulated, more markedly so than would appear from the published photographs (loc. cit., same figs.). The male superior anal appendages are equal in length to, or a trifle longer than, segment 10. When viewed from within, the appendage shows a peculiar armature, which is best shown in fig. 18. A broad, robust somewhat molar-like tubercle is placed about midway its whole length, at the base of the finger-like downpointing process; this tubercle is subrectangular in outline, with shal-

lowly emarginate margin, its main portion being bluntly triangular and about equal in size to the true apex of the appendage. In these respects *kimminsi* differs from *ramosa*, in which the interior process is considerably smaller, while the true apex of the superior appendages is longer and more slender (cf. figs. 21 and 22).

**Lieftinckia isabellae** spec. nov.  
(figs. 11, 19)

Material. — Solomon Is.: 3 ♂ (two adults, one headless, one subadult), Santa Ysabel I., Maring Distr., Ta Matahi, 2.vii.1960, C. W. O'Brien. Holotype ♂ adult and one paratype ♂ (ML), one paratype ♂ (BISH).

Stature more robust than *lairdi* and the larger-sized *kimminsi*, with a shorter and more compactly built synthorax, narrower wings, more normally lozenge-shaped pterostigma, lighter coloured end segments of abdomen, and quite differently shaped anal appendages.

Male. — Labium yellowish, palpi ferruginous, emargination of midlobe roundish, U-shaped, its depth less than ¼ whole length of mentum. Labrum, mandibles (save the tips light ferruginous), anteclypeus and whole genal area, deep brownish black mixed with ferruginous, surface of all parts brightly shining. Postclypeus subhorizontal, its anterior 2/5 deep black, this mark widest at middle and convex behind, the anterior ridge sharply pronounced; colour otherwise bright chrome to orange (full coloured male), whole surface shiny, the light colour surpassing fronto-clypeal suture and continued upward to form a complete broad transverse band of orange extending from eye to eye, occupying the frons as far dorsad as the rather swollen black antennal sockets. Rest of the head above, inclusive of the occipital ridge, uncoloured dull velvet brownish black; rear of head otherwise ochreous. Antenna rather shorter than upper orbital line; scape short and cylindrical, only little longer than its own diameter, black with slight greenish hue; pedicel much more slender, subequal in length to scape but about twice as long as its diameter, colour yellowish; flagellum indistinctly segmented, black.

Main body of prothorax much shorter than in *kimminsi* and *lairdi*, hardly twice as long as its anterior lobe, the latter shaped similarly though much larger in size; pronotal tubercles weakly convex in side view, relatively larger and broad-

er than in the two species mentioned but of the same simple collar-like form, the side-edges narrowly rounded off.

Synthorax distinctly shorter and more expanded than in both *kimminsi* and *lairdi*. Colour-pattern a soft light rusty brown variegated with a mixture of delicate cream-yellow and pale green, the latter forming incomplete, ill-defined antehumeral bands tapering upward, separated above from a pair of almost conjoined juxtahumeral patches of the same colour, one placed before, the other just behind the suture; metapleurae marked with two, almost complete light bands, both ill-defined but of the same tint as the dorsal spots, separated from one another by an equally diffuse rusty brown band over the second suture. Whole ventral surface of thorax uniform pale ochreous, this tint turning to light green only along ventral metepimeral ridge.

Legs throughout light rusty brown, as on most parts of the thorax, posterior femoral ridges finely black from near base to apex, the knees and extreme base of tibiae, distinctly ringed with dark brown, diffuse lighter brown annules placed slightly beyond halfway length of femora also discernible in two out of three males; colour of tibiae and tarsi as well as all bristles somewhat more obscured than on the femora; hind femur long, reaching back to very slightly over the apical border of segment 1, with 11–12 long bristles in outer row.

Wings notably longer in proportion to the relatively short and very slender abdomen: fore wing when folded attaining base of segment 7; shape and neuration as in fig. 11; marginal undulations of apical portion quite distinct; veins almost black, membrane subhyaline. Arculus at  $Ax_2$  in all six wings;  $M_3$  arising at or a trifle distal to the subnodus,  $Rs$  at  $Px_1$ ; anal bridge reaching the wing border at level of the prolongation of  $Ax_1$  or slightly distal to that point. Fore wing with 21–22, hind wing with 18–19  $Px$  of first series. Area enclosed by  $C$  and  $R_1$  posterior to pterostigma irregularly veined: very rarely with only a single cell-row, usually made up of more than 2 (1–6) duplicated cells (fig. 11).

Abdomen slender, though relatively a little shorter than in both *kimminsi* and *lairdi*, from segment 7 on gradually somewhat expanded. Colour much as described for the other congeners: tergites bright yellow to dusky ochreous (depending on the state of maturity), but greater part of 2–6 much darker dorsally, brown to almost black from end to end, the light parts

forming more or less distinct basal rings, except 1 unmarked and basal one-third of 2 also remaining yellow, its dorsal black mark pointing forward; 8–10 and anal appendages pale, lacking dark areas, only 7 occasionally obscured upon middle of tergite.

Anal appendages short and compact, shaped as in fig. 19.

Measurements: abdomen + appendages 33.8–35.2 mm, hind wing 22.5–24.5.

Female unknown.

*Lieftinckia ramosa* spec. nov.  
(figs. 13, 20–23)

Material. — Solomon Is.: 1 ♂ (holotype, adult, right hind wing and apex of left fore wing missing), San Jorge islet, off Santa Isabel, 26.ix.1965, "*Casuarina* forest, low herbage near stream", Roy. Soc. Exped. Brit. Mus. 1966 (BM) ["small island to the SW of Santa Isabel separated only by a small channel, but has a slightly different geological formation", pers. comm. by Peter Ward, BM]. — 1 ♂ (adult, paratype), labelled "*Idiocnemis inornata* Selys Bougainville", in R. Martin's handwriting (ex MP, in ML).

Male (holotype, San Jorge). — Labium dark brownish orange. Labrum, mandibles, genal area and anteclypeus obscurely reddish black, very shiny; postclypeus (with the anterior border remaining black) bright shiny orange-rufous, as are also a pair of trapezoidal spots, one each side, connecting edges of postclypeus with inner orbital margin in front of antennal sockets, which are dull black; frons, antennae, vertex, epicranium and occipital region, all lustreless deep black, only a small area next to the foramen on postocciput somewhat lighter, reddish black. Antenna black, scape thick, squarish, the pedicel more slender, cylindrical, but only 1¼ times as long as scape; distalia missing.

Prothorax, including anterior and posterior lobes, reddish black above, the sides throughout deep chrome; pronotal tubercles low, evenly convex; posterior lobe broad, not modified, depressed, almost straight behind, but distal border distinctly upturned, with rounded side-angles.

Synthorax predominantly dark rufous intermingled with vinaceous brown, variegated with paler vinaceous and yellow areas which are nowhere sharply outlined; black are: mesoprescutum, middorsal carina, margins of ante-alar triangles, and shiny black dots at all dorsal ridges inclusive of lateral sutures and posterior edge of



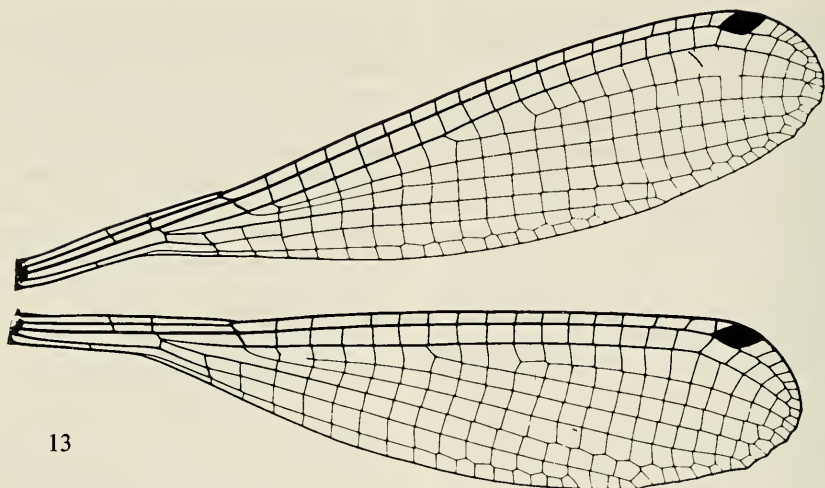

13

Fig. 13. Wings of *Lieftinckia ramosa* spec. nov. (Bougainville).

metepimeron. Mesepisterna with faint indication of lighter antehumeral bands, which are broadening and somewhat better defined upward to form definitely yellow, subcircular dots; sides with some lighter colouring dorsally upon the mesepimeron and a wedge-shaped chrome-yellow streak, pointing upward, along mid portion of first suture, the latter not quite reaching metaspiracle; some yellow also on middle of mesinfraepisternum and posterior edge of metepimeron; ventral surface pale.

Legs light rufous, but coxae paler and all femora with ill-defined, broad, brownish rings and dark brown apices; all spines and bristles rufous.

Shape and neuration of wings almost exactly as shown in fig. 13, for the male from Bougainville, but pterostigma a little more oblique and higher than in the type, its costal side distinctly shorter than the proximal, and distal side convex outwardly. Fore wings with 18, one hind wing with 17 Px of first series; arculus distinctly distal to Ax<sub>2</sub>. Pterostigma dark reddish brown.

Abdomen very slender, terminal segments, from base of 8 to end of 10 gradually broadened, shaped much as in fig. 20. Colour mainly dark brown, segment 1 pale ferruginous above, the raised posterior border obscured and the sides also somewhat darkened; 2 obscurely brown with a diffuse yellowish basal annule and an indistinct stripe of the same colour along lower margin of tergite; 3—7 dark brown deep-

ening gradually to almost black posteriorly, each showing low metallic lustre above and all with small but fairly distinct yellow basal rings, prolonged caudad alongside for a short distance, those on 3 and 7 narrowly interrupted by brown at the middorsal line; intersegmental rings obscured but on 3—6 preceded laterally by minute, ill-defined yellowish apical spots; dorsum of 8 lighter brown, its sides more broadly ferruginous; 9—10 and anal appendages entirely brownish orange to ferruginous, the swollen postero-lateral border of 10 with a black streak.

Anal appendages as in fig. 20; apices of inner spur of superior pair as well as the incurved tips of the inferiors, black.

Male (paratype, Bougainville). — Resembles the type in most respects, but differs slightly in body colour and structure of appendages, as follows. Glossy surface of anterior parts of head uniform dark rufous instead of almost black, transverse clypeal band rather more orangish, less defined, and all the rest of head including antennae and undersurfaces, rufous, lacking dark areas. Pro- and synthorax as described for the type, except that there are no definite yellow areas on the mesepisterna, which instead bear a pair of complete, narrow and straight, cinnamon-coloured antehumeral stripes not strongly contrasting against the dark orange-rufous ground; sides with faint indication of a greenish superior spot just below dorsal crest of mesepi-

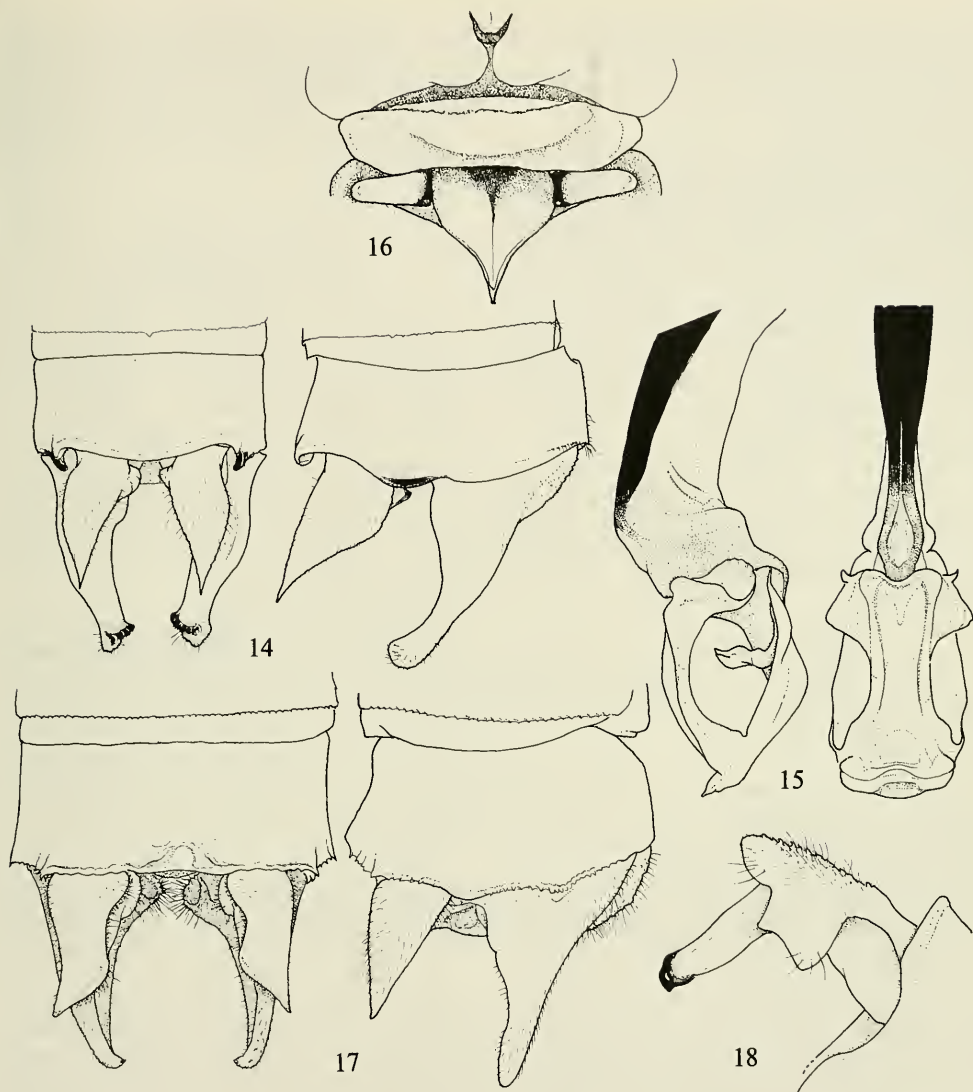

Figs. 14—18. Platycnemididae. — 14, Male anal appendages of *Salomocnemis gerdae* spec. nov., dorsal and right lateral view; 15, Idem, ligula of male left lateral view and ventral view; 16, Idem, mesostigmal laminae of female; 17, *Lieftinckia salomonis* Kimmins, male anal appendages, dorsal and right lateral view; 18, *L. kimminsi*, left superior appendage, innerside.

meron, also traces of light green on infraepisternite and lower edges of metepimeron. Legs badly damaged and broken.

Wings (fig. 13), neuration brown. Fore wings with 18, hind wings 15—16 Px of first series; pterostigma brown.

Abdomen shaped and coloured as in the type, except tergite 8 also showing traces of a latero-

basal yellow spot. Anal appendages (fig. 23), very similar to those of the type, but lower branch of superiors slightly thicker and shorter, forming an angle of about  $80^\circ$  with the main branch (obtuse-angulate in the type), and inner tubercle about halfway length of superior appendages a little less pronounced.

Measurements: ♂ abdomen + appendages

31.3 mm, hind wing 20.2 mm (San Jorge); 30.4 and 20.0 mm, respectively (Bougainville).

Female unknown.

This very distinct species has no near allies among its congeners inhabiting the Solomon chain but it approaches *kimminsi* most closely by having only a single row of cells between the veins C and  $R_1$  beyond the pterostigma, and by having a branched apex of the superior appendages. It differs, among other characters, from both *kimminsi* and *lairdi* by its more abruptly petiolated wings, less pointed wing tips, and the quite characteristically shaped and coloured head and thoracic markings.

I am not quite certain about the correctness of the locality "Bougainville", as written on the label by R. Martin himself. In fact several instances are known of Odonata in Martin's collection whose reported habitats later proved to be erroneous.

*Lieftinckia* spec. indet.

Material. — Solomon Is.: 1 ♀ (subadult), San Cristoval I., Wainoni, 22.vii.1965, Roy. Soc. Exped. Brit. Mus. 1966 (BM).

This species is no doubt a near ally of *L. salomonis*, but apparently quite distinct. Although the shape of the prothoracic hind lobe with its lateral blades and the peculiarly inflated mesoprescutum are developed similarly to those of *salomonis*, the mesoprescutal outgrowth in the present specimen is much narrower and sulcate medially, while the posterior lobes of the prothorax are subtriangular in outline. The colour-pattern also resembles that seen in *salomonis*; and, like that species, there are two cell-rows between the nervures C and  $R_1$  beyond the pterostigma. This San Cristoval insect is, however, a good deal smaller in size than *salomonis*.

By the absence of a topotypical male I prefer to leave this species unnamed.

*Lieftinckia* spec. indet.

Material. — Solomon Is.: 1 ♀ (juvenile, left hind wing missing), San Cristoval I., Camp 2, 24.vii.1965, Roy. Soc. Exped. Brit. Mus. 1966 (BM).

This ♀ belongs to another undescribed species left without a name. It is immature and in rather poor condition.

Posterior lobe of prothorax trapezoidal, rath-

er saddle-shaped lacking projecting side-lobes; no mesoprescutal outgrowths. Only a single row of cells between C and  $R_1$  beyond pterostigma.

Size small: abd. 31.5 mm approx., hind wing 22.5 mm.

COENAGRIONIDAE

*Teinobasis* Kirby, 1890

*Teinobasis* is a fairly large genus with over sixty named taxa and probably more than twenty still undescribed species and subspecies. The genus is wide-spread all over southern S.E. Asia, Micronesia, the Melanesian islands, and the northernmost parts of Australia. Only two or three outlying members, doubtfully generically distinct from *Teinobasis*, are known from Malawi, a country on the verge of Ethiopia proper, and the Malgassian subregion (genus *Seychellibasis* Kennedy, 1920).

At the time of summarizing the regional species of *Teinobasis* (Lieftinck, 1949), no members other than *T. aluensis* Campion and *rufithorax* (Selys), had been known to occur in the Solomon Islands. On that last occasion, three more species were added to the list, but all were based on single specimens: two on immature females and the third on a male erroneously attributed to *Papuaग्रion* Ris, 1913. In the present paper all of them are revised, partly synonymized, and their structures more properly analysed. This has led to the recognition of 8 species (including one left without a name), of which the following 7 are believed to be validly named, viz., *T. aluensis* Campion, *bradleyi* Kimmins, *chionopleura* spec. nov., *imitans* spec. nov., *obtusilingua* spec. nov., *rufithorax* (Selys), and *simulans* spec. nov. As to the most widely distributed and best known *rufithorax*, this is only briefly mentioned in the next pages and will not concern us here any further. All others are probably endemic to the Solomons.

Insufficient acquaintance with *T. aluensis* must be held responsible for my erroneous assignment of *gurneyi* to a new species of *Papuaग्रion* Ris, 1913. The latter is a Papuanian genus closely related to *Teinobasis* but with a more restricted range, comprising many, generally more sturdily built damselflies centred in New Guinea. Considering all characters used to separate these two genera (Lieftinck, 1932, 1935, 1937-38, 1949), and after re-examing the type-species, I arrived at the conclusion that *T.*



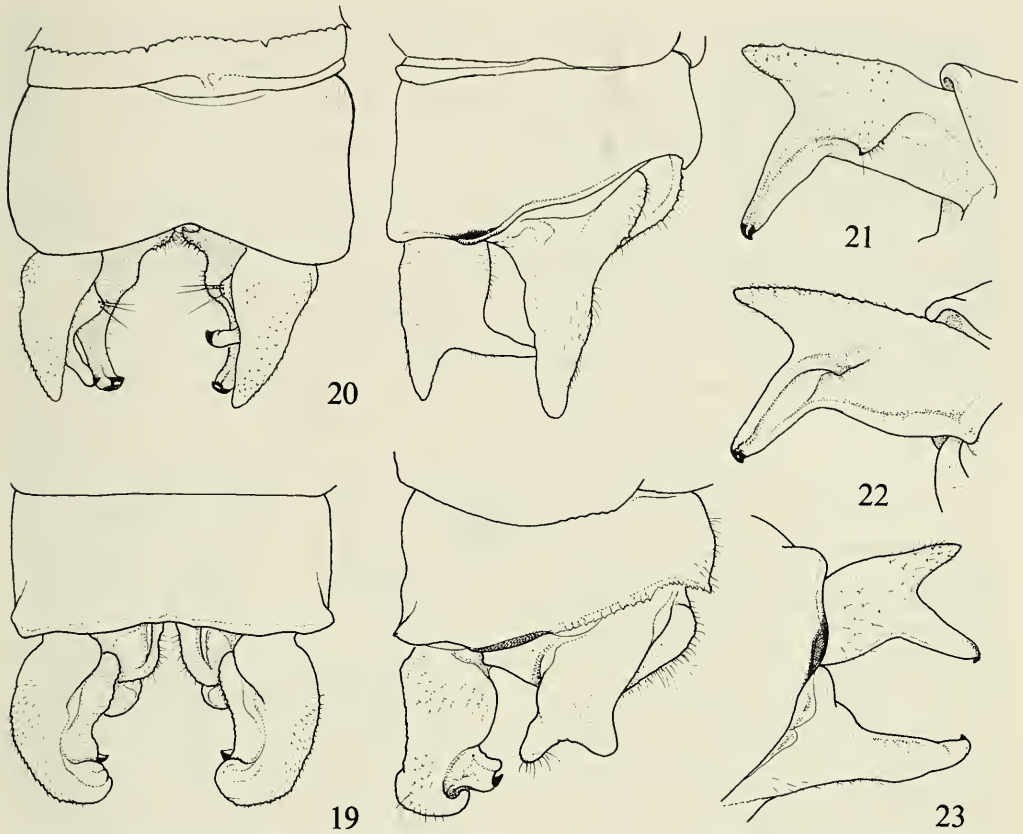

Figs. 19—23. Male anal appendages of *Lieftinckia* species. — 19, *L. isabellae*, dorsal and right lateral view; 20, *L. ramosa* spec. nov., dorsal and right lateral view (San Jorge); 21, *L. ramosa* spec. nov., inside of superior appendage (San Jorge); 22, Idem (Bougainville); 23, Idem, left lateral view (Bougainville).

*aluensis*, *emarginata* and *gurneyi* should be reunited and placed in *Teinobasis*, the last two being obviously conspecific with *aluensis*, i.e. the earliest described member of this insular group. They were also compared with a few more recently discovered species, mentioned above and described below as new. They form a closely interrelated group differing markedly in details of structure and venation from *Papuagrion* (for references, see above). With the exception of the smaller-sized ones amongst the new taxa, two of them, *simulans* (New Georgia) and *imitans* (Guadalcanal), come very near *aluensis* and with much more material may even turn out to be only insular subspecies of the latter. As only few specimens are available for comparison, and no representatives of the *aluensis* cluster have so far been discovered in the intervening islands of

the Solomons, questions of subspeciation and relationship cannot yet be answered. In the present case it seems best to keep all taxa apart as full species. It should be borne in mind that all of them exhibit a certain amount of variation in body colour and extent of markings, a well known disadvantage mainly depending on the insect's stage of maturity, — in fact a real handicap frequently hampering easy recognition of similar-looking species of *Teinobasis* and allied genera!

In the present context a few remarks are perhaps worth attention bearing upon the intricate and diversified structure of the end segments of the male abdomen, especially with regard to the conjunction and flexibility of their relation to one another. These sclerites, with their appendages, are most complex in certain genera pres-

ently still united in the subfamily Pseudagrioninae (Davies & Tobin, 1984), a very large and heterogeneous group of genera. Some of the Old World members, like *Pseudagrion* and *Archibasis*, contain generalized and easily recognizable forms, whereas others are more highly specialized, viz. *Amphicnemis*, *Nesobasis*, *Papua-grion*, *Pericnemis*, *Teinobasis*, and some annectent genera with fewer species. Regarding the last group, it may be remembered that I once redescribed and illustrated some species of *Amphicnemis* and *Teinobasis* occurring in the Philippine Islands. These had been characterized already by Brauer (1868: 541—546), de Selys (1877: 114), and subsequently also by Needham & Gyger (1939). On two occasions (Lief-tinck, 1953: 250 and 1957: 161—170), I pointed out that the lower (inner) branches of the upper pair of appendages had been mistaken by all authors for the inferiors, possibly because the latter are sometimes longer and stronger than the upper (main) branches of the superiors, occasionally abutting tightly on the major part of the inferior pair as well, even in the remarkable zygo-pteran *Pericnemis stictica* Selys. In that species the slender lower branch of the superiors is almost as strongly developed as the pincer-like upper portion. In all known genera of the *Teinobasis* alliance, the superior appendages are deeply divided and consist of two well-developed branches. From dissections and pictures of these sclerites drawn in caudal view, it became quite clear that these processes are parts of a single appendage whose branches are firmly and immovably connected basally, forming together the true superior appendage. Consequently, the interpretation and terminology of the male genital organs as given by Needham & Gyger (1939), are incorrect.

A further complication sometimes averting immediate recognition of the various components of the terminalia, is caused by the existence of a median sclerite emerging from beneath the overhanging ridge of the posterior border of the 10th tergite. This accessory sclerite is usually placed in a vertical plane so as to protect the aperture and the more weakly sclerotised membrane of the body wall. In the course of years, numerous drawings of that structure were published showing it in caudal (see e.g. Liefertinck, 1962, and the author's papers (1932—1949), cited above. It is here termed "Breech-Block"; and though showing great diversity in size and shape among species, its form seems to be quite stable specifically. Its function

is unknown, but in view of the complex form of the female pronotal lobes and mesostigmal laminae, its flexibility is supposed to play an important role in the pre-copulatory process.

#### *Teinobasis aluensis* Campion (figs. 24—26)

- Teinobasis aluensis* Campion, 1924: 614, fig. 2 (♂ app.), ♂ Alu I. (Shortland Is. group). — Kimmins, 1934: 107 (type fixed, ♀ topotype, not descr.). — Liefertinck, 1949: 343 (note on type).  
*Teinobasis emarginata* Liefertinck, 1949: 344—345, fig. 6 (♀ proth.), ♀ juv., Shortland Is. *Syn. nov.*  
*Papua-grion gurneyi* Liefertinck, 1949: 341—343, fig. 5 (♂ app.). — ♂ Bougainville I. *Syn. nov.*

Material re-examined. — Solomon Is.: 1 ♂ (adult), Alu, Solomon Is., C. M. Woodford 87—3, with D. E. Kimmins's confirmative type label, holotype *T. aluensis* Campion (BM); 1 ♀ (juvenile), topotypical, det. D. E. Kimmins (BM). 1 ♀ (juvenile), Shortland Is., Hisiai River, 22.x.1936, R. A. Lever, holotype *T. emarginata* Liefertinck (ML). — 1 ♂ (adult), Bougainville I., 6.viii—16.xi.1944, A. B. Gurney, holotype *Papua-grion gurneyi*, Liefertinck (USNM).

To the original description a few more details can be supplemented.

Male (adult, holotype Alu I.). — Labrum broadly bordered with yellow-ochre roundabout its obscured centre. Face and frons entirely blue inclusive of the impressed area of the frons. Antennae pale (incomplete). Prothorax short, not modified. Synthorax with complete bronze-black middorsal band occupying the inner halves of the mesepisterna, beyond which the light non-metallic ground is discoloured and obscured; the dorsum gradually acquires a lighter tint beyond the humeral suture, but the somewhat obscured bluish mesepimera are entirely without the distinct wedge-shaped bronzy mark(s) seen in *simulans* and *imitans*; sides otherwise blue fading to yellowish underneath. Legs short, resembling *Papua-grion* in form; femoral bristles relatively strong, numbering 3, 4, —, respectively (posterior legs missing), slightly shorter than the interspaces; tarsal claws lacking a subapical inferior tooth. Wings much as described for *gurneyi* (loc.cit., 1949) and the other close allies; M<sub>3</sub> and Rs closely approximated at origin, M<sub>3</sub> weakly curved, arising very slightly before, Rs at the subnodus, both veins remaining separated thereafter. Ab entering the posterior margin well beyond Ac; medio-anal link entire; three postquadangular antenodal cells. All wings with 15 Px of first series. Pterostigma as in *simulans*.

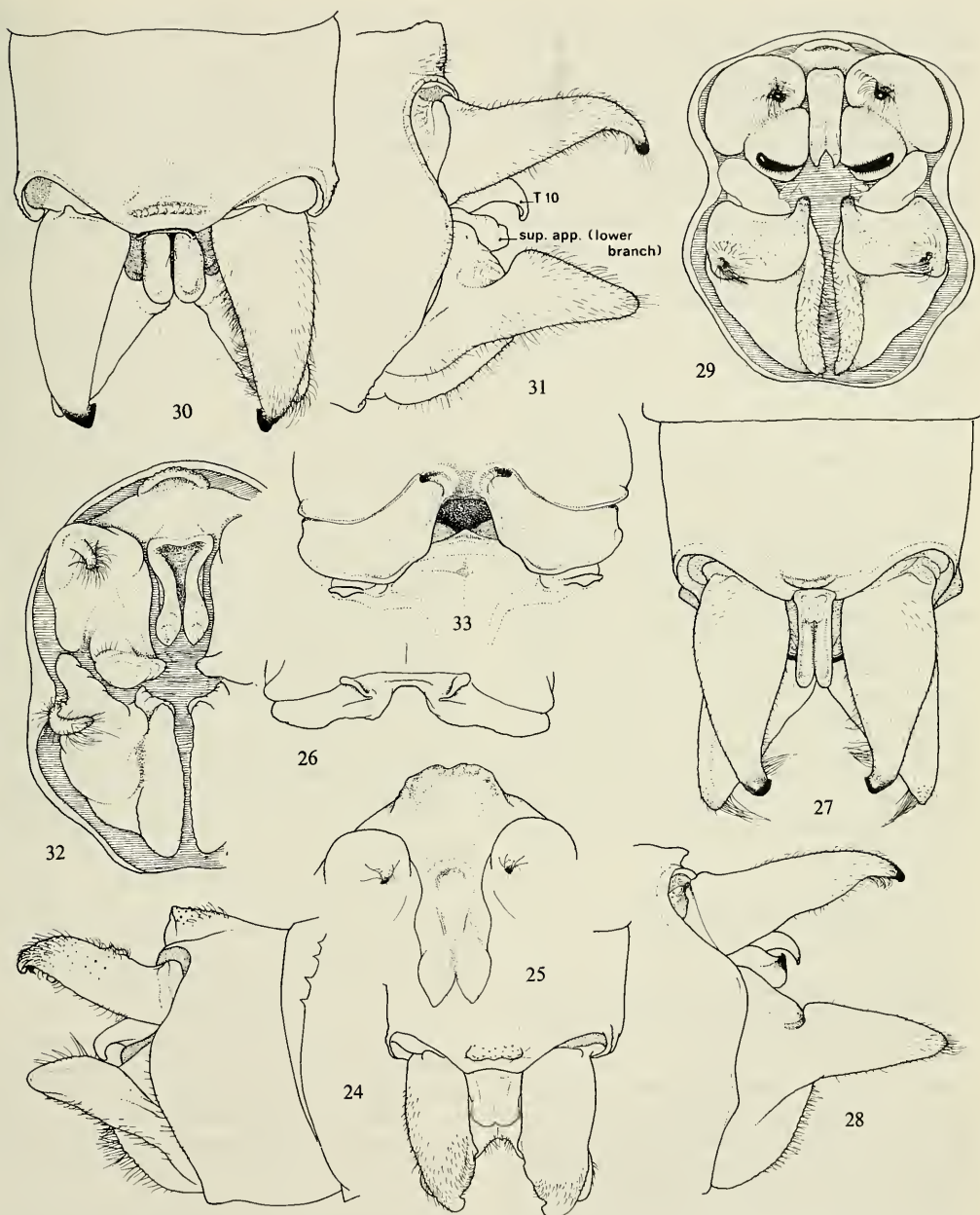

Figs. 24—33. *Teinobasis* — 24, *T. aluensis* Campion, male anal appendages, left lateral and dorsal view (type of *T. gurneyi*); 25, *Idem*, caudal view; 26, *T. aluensis* Campion, hind margin of prothorax of female (type of *T. emarginata*); 27, *T. simulans* spec. nov., male anal appendages, dorsal view (New Georgia); 28, *Idem*, left lateral view; 29, *Idem*, caudal view; 30, *T. imitans* spec. nov., male anal appendages, dorsal view (Guadalcanal I.); 31, *Idem*, left lateral view; 32, *Idem*, caudal view; 33, *T. imitans* spec. nov., prothorax of female, dorsal view (Guadalcanal I.).



Abdominal tergite 10 in caudal view shaped much as shown for the type of *gurneyi* (fig. 25) and *imitans* spec. nov. (fig. 32), the vertical surface of the raised upper part of the body-wall slightly convex, black in colour, but its mid-apical process bright yellow (deep black in *simulans*), at first directed obliquely caudad, then strongly hooked, recurved, with bilobed apex.

Anal appendages equal in length to segment 10; colour yellow; superior pair relatively short and broad in dorsal view, slightly but distinctly S-shaped in side view, as shown for *gurneyi* (fig. 24).

Measurements: abdomen + appendages 48 mm, hind wing 31.5 mm.

Female (juvenile, "red" colour phase, Alu I.). — This (undescribed) teneral specimen was examined by me at the British Museum (Natural History) after publication of *T. emarginata*, with which it agrees in most respects, especially in the venation. Prothorax similar to *emarginata*, except that the deeply divided lamellae of the posterior lobe are somewhat more drawn out at the inner edges, so as to resemble the adult female of *imitans* (fig. 33) more closely; in *emarginata* the lobes are more depressed and shrunken owing to the teneral condition of the sclerite. Metallic green marks covering the thoracic dorsum in the form of ill-defined bands occupying the inner halves of the mesepisternites. Its measurements are: abdomen 41.5 mm, hind wing 30 mm.

#### *Teinobasis simulans* spec. nov.

(figs. 27—29)

Material. — Solomon Is.: 1 ♂ (adult), New Georgia I., Bareki River, 30.viii.1965, Roy. Soc. Exped. Brit. Mus. 1966—1. Holotype (BM).

Male (adult). — Labium yellow; basal half of labrum (including the central pit) glossy brownish black, its distal half sharply defined bright ochreous; mandible-bases and genae dark olive, anteclypeus more brownish olive, postclypeus dark brown. Frons with well pronounced, almost rectangular transverse anterior crest, the smooth vertical surface dark olive; upper surface of frons, antennal sockets and all remaining dorsal parts of head dull greenish bronzy black with some traces of brown just in front of the ocelli and along occipital crest; occipital area and rear of the head dirty orangish. Scape and pedicel of antenna yellowish, the latter about

1½ times length of scape, its apex brown; distalia black.

Pronotum dark brown, lower portion of tubercles fading to rusty brown, the latter low and but little convex; sides including those of posterior lobe rusty brown, the lobe short and broad, longest at middle, somewhat upturned, its surface convex anteriorly; posterior border in dorsal view throughout evenly and but slightly convex, the side lobes small, not protuberant and rounded.

Dorsum of synthorax as far down as a little before humeral suture and including ante-alar triangles, black with low but distinct metallic green lustre, a hairline at the humeral suture remaining rusty brown; mesepimeron rusty brown, its lower (anterior) half marked with a wedge-shaped brown spot pointing upward and ill-limited above, posterior portion yellowish green, as are also the remaining parts of the sides and ventral surface of thorax; mesinfraepisternites rusty brown with a subcircular blackish central dot low down.

Coxae and trochanters of legs light green; legs otherwise pale ochreous; but outer faces of all femora with two brown stripes partly fused together beyond halfway length; extreme bases and carinae of tibiae as well as all bristles, brown. Hind femora with 4—5 strong bristles in outer row, all a little shorter than the interspaces; tarsal claws lacking an inferior subapical tooth, or a rudiment of a tooth only at the fore tarsi.

Wings narrow, venation brown. Ac situated much nearer Ax<sub>2</sub> than Ax<sub>1</sub>, its length a little less than half its distance from proximal side of quadrilateral, which is scarcely longer than Ac itself; Ab enters the margin well distal to Ac at a distance of about twice the length of Ac. Arculus at Ax<sub>2</sub> in all wings. Quadrilateral in fore wing with proximal and costal sides of equal length, in hind wing costal side markedly longer than proximal side. Medio-anal link entire; three subquadrangular antenodal cells. M<sub>3</sub> moderately curved at origin, arising slightly before the subnodus (least so in fore wings), Rs at the subnodus, both veins very closely approximated (just not fused together), from their meeting point to almost as far as Px<sub>1</sub>, thence gradually diverging. Broken course of M<sub>4</sub> and Cu<sub>2</sub> dissimilar: fractured portion of M beginning beyond halfway its length, that of Cu<sub>2</sub> much before that level, i.e. at level of Px<sub>2</sub>—Px<sub>3</sub>. Fore wing with 15—16, hind wing with 14—15 Px of first series. Pterostigma of small size, braced, lozenge-

shaped but very oblique, a little longer than high, its proximal side only a trifle more oblique than the distal one; colour cinnamon, darker brown centrally.

Abdomen long and slender, basal and terminal segments moderately expanded. Segment 1 light blue-green, distal one-fourth of tergite with crescent-shaped transverse brown mark and traces of rusty brown in front of the latter; dorsum of 2 metallic green from base to apex, this mark very slightly expanded before the end, the sides blue-green; succeeding segments for the greater part brownish black with slight bronzy reflections, 3—7 each with pair of small, greenish yellow basal spots forming dorso-lateral annules narrowly interrupted from behind in the median line; sides of 8 with a yellowish stripe, broadest at either end bordering lower margin of tergite; 9 with transverse basal stripe of yellow alongside; 10 with similar stripes basally, the sides as well as the apical 1/3 of the upper surface of this tergite likewise brownish yellow. Intersegmental rings of 8—9 and 9—10 pale. Configuration of 10th tergite and anal appendages as shown in figs. 27—29; colour brownish yellow, including the midapical process of tergite 10; lower branch of superior appendages ending in a transverse, smooth, shining black ridge bearing minute erect light hairs; fringes on the inside at tips of superiors and long tufts at apices of inferior appendages, all pale golden yellow.

Measurements: ♂ abdomen + appendages 46.6 mm, hind wing 29.0 mm, pterostigma 0.5 mm.

Female insular topotype, unknown.

***Teinobasis obtusilingua* spec. nov.**  
(figs. 37—39)

Material. — Solomon Is.: 2 ♂ (adult, one in fragments), San Cristoval I., Huni River, mouth Camp 4, 14.viii.1965, "in and around small pools in *Casuarina* forest on basic soils". *Rov. Soc. Exped. Brit. Mus.* 1966-1. The perfect specimen is the holotype (BM), the fragmentary one a paratype (ML).

Male (adult, holotype). — Labium yellowish; labrum almost wholly black, only anterior narrowly lined with yellow. Mandible-bases yellowish with a large central spot of brown; genae and anteclypeus dirty brownish, postclypeus glossy brownish black. Frons shaped as described for *chionopleura*, colour deep black with faint bronze reflections, the sulcus between clypeus and frons brown. Head otherwise dull

bronze-black, save for a pair of small, oblique pale streaks, one either side, between base of antenna and lateral ocellus; occipital ridge also somewhat lighter. Rear of head apparently brownish black or black except anteriorly a triangular yellow mark at level of submentum. Antennal scape very short, black, at most one-third as long as pedicel, which is yellowish streaked with brown, flagellars long and slender, black.

Prothorax including posterior lobe, bronze-black, the main portion bearing a broad x-shaped mark occupying the whole dorsum, sides greenish yellow; posterior lobe simple, depressed, much broader than long, surface convex, hind border evenly and broadly rounded, the side-angles narrow, not projecting, rounded. Dorsum of synthorax, as far down as the humeral suture and including ante-alar triangles, black with distinct bronze and coppery reflections; mesepimeron pale rust-coloured, marked with an irregular bronze-black band that covers the lower 2/3 of the area but dorsally narrows abruptly to a stripe extending upward along the impressed part of the first suture, the latter curving round the black dorsal crest so as to almost meet an elongate blackish streak along upper end of second suture; remaining parts of side and ventral surface unicoloured greenish yellow; mesinfraepisternites more rust-coloured, with a large subsquarish patch of bronze-black covering most of that sclerite.

Legs pale ochreous, the coxae mixed with green; outer faces of all femora and the knees narrowly, with complete thick dark brown stripe; four strong dark brown bristles in outer row and five in inner row of hind femora, all shorter than the interspaces. Tibiae and tarsi unmarked; tarsal claws simple, or with the merest trace of an inferior subapical tooth.

Wings narrow, shaped as in *bradleyi*, the apices slightly more pointed. Ac much nearer  $Ax_2$  than  $Ax_1$ , only about one-third as long as its distance from proximal side of quadrilateral, which is nearly twice as long as Ac itself; Ab enters the margin well distal to Ac at a point away from it for about twice the length of Ac. Arculus distinctly distal to  $Ax_2$  in all wings. Quadrilateral longer than in *bradleyi*, its costal side in fore wing longer than proximal side, in hind wing more markedly so. Medio-anal link entire; three postquadrangular antenodal cells. Origin of  $M_3$  and Rs close together,  $M_3$  moderately curved at origin, arising a trifle before subnodus in fore wings, at the latter in hinder pair;

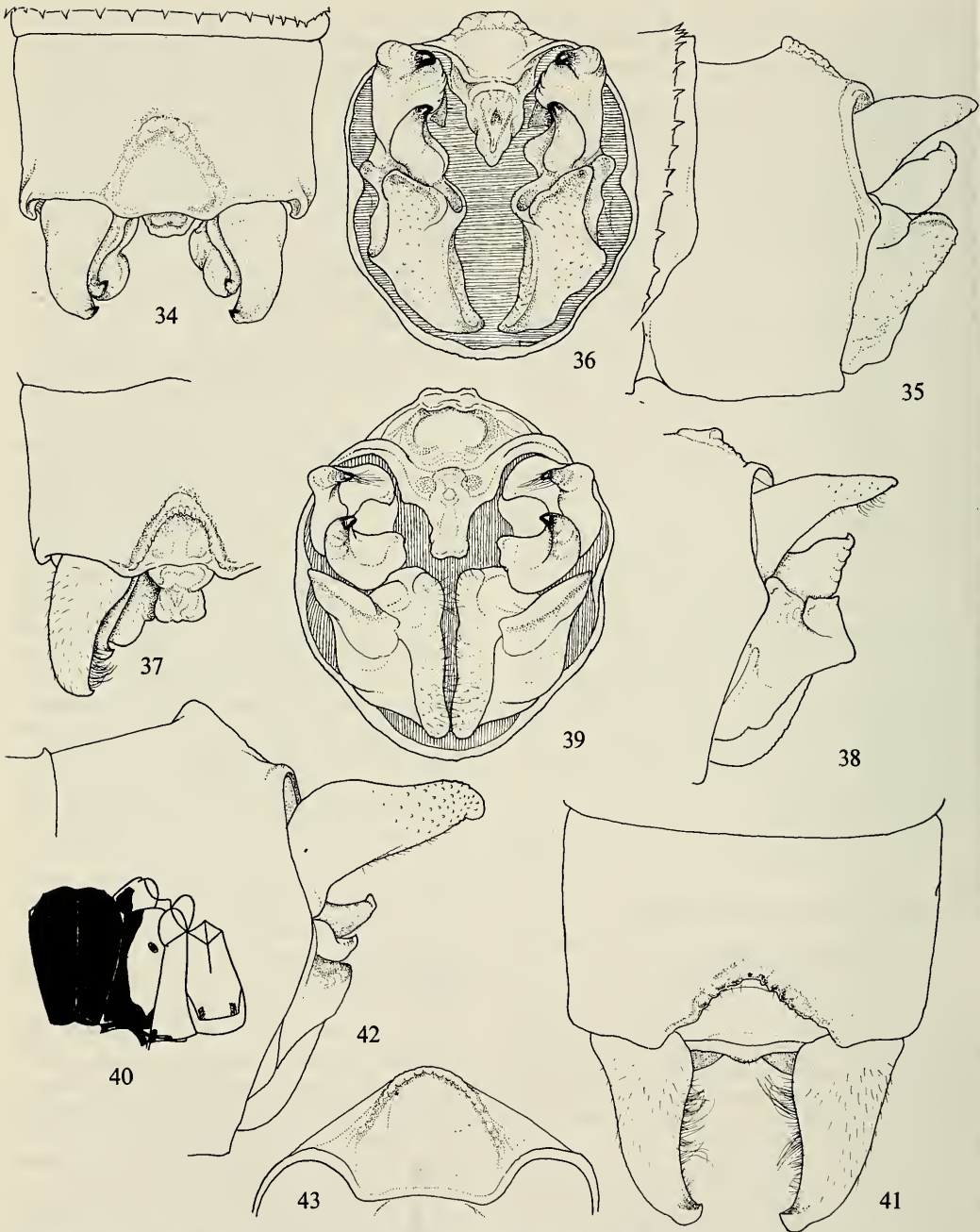

Figs. 34—43. *Teinobasis*. — 34, *T. bradleyi* Kimmins, male anal appendages, dorsal view (Bougainville I.); 35, Idem, left lateral view; 36, Idem, caudal view; 37, *T. obtusilingua* spec. nov., male anal appendages, dorsal view (San Cristoval I.); 38, Idem, left lateral view; 39, Idem, caudal view; 40, *T. bradleyi* Kimmins, thorax; 41, *T. chionopleura* spec. nov., anal appendages, dorsal view (holotype male, Sandfly I.); 42, Idem, left lateral view; 43, Idem, caudal view.



Rs arises a little beyond the subnodus, while both veins gradually diverge immediately after their meeting point (in right hind wing they are fused together for a short distance!). Broken course of  $M_4$  and  $Cu_2$  as described for *bradleyi*. Fore wing with 13—14, hind wing with 12 Px of first series. Pterostigma of small size, long and narrow, braced, much smaller than underlying cell and almost twice as long as high, sides oblique but proximal side distinctly more oblique than distal side; colour deep black.

Abdomen long and slender, shaped much as in *bradleyi*; tergite 1 yellow-green with a trapezoidal bronze-black marking occupying most of the dorsum and broadest posteriorly; 2 with the dorsum bronze-black from base to apex, this mark a little constricted at extreme base and hardly expanded subapically, the sides possibly greenish in life; succeeding segments for the greater part bronze-black, 3—6 or 3—7 each with narrow yellowish basal annules which successively become more broadly interrupted and placed more laterad posteriorly; 8—10 apparently unmarked, but intersegmental rings of terminal segments yellowish.

Configuration of 10th tergite and anal appendages as in figs. 37—39; colour black, except the dorso-apical ridge, the thickened posterior border of last tergite, and most of the inferior pair of appendages, which are light brown; subapical hair-fringe springing from inner faces of superior appendages, also pale.

Measurements: ♂ (holotype) 37.0 mm, hind wing 21.8 mm, pterostigma 0.5 mm.

Female unknown.

***Teinobasis chionopleura* spec. nov.**  
(figs. 41—43)

Material. — Solomon Is.: 1 ♂ (adult, holotype), Florida Is., Ngela group, Sandfly Island, Takavali, 22.xii.1965, "common in forest", R. Slooff (ML); 1 ♂ (adult, discoloured), Florida Is., Small Ngela I., Dende, 18.ix.1960, C. W. O'Brien (ex BISH, ML); 1 ♂ (adult, head and part of abdomen missing), Florida Is., Big Florida I., 28.xi.1944, H. E. Milliron (BISH).

Male (adult, Sandfly I.). — Whole labium, including submentum and all parts in front of the foramen, light chrome as are also the genae as far back as the base of squamae, only the mandibles tipped with black. Labrum, clypeus and a transverse band in front of frons connecting the eyes, which reaches up as far as the antennal bases and including the antennal sockets, all

unicoloured orange-chrome. Frontal ridge weakly developed, obtuse-angulate, surface of frons uneven but lacking transverse wrinkles. All the rest of head behind the frontal ridge, entirely dull greenish black to black without any light markings, the rear also wholly black but postoccipital lobes with a pair of bluish pruinulent patches. Scape and pedicel of antenna of the usual shape, short and subequal in length, both obscured but apex of scape yellow-ringed.

Pro- and synthorax entirely metallic bronzy black, all sclerites (except upper portions of meso- and metepimera) thickly overlaid with palest blue pruinescence, leaving only traces of the orangish ground colour at dorsal ends of humeral and first lateral sutures, and posterior edge of metepimeron.

Coxae, trochanters and extreme bases of femora, black, these parts pruinulent blue all over; legs otherwise light orange-yellow, the tips of femora narrowly obscured and all bristles black; femoral bristles slightly longer than the interspaces, numbering 2 + 2, 6—7, and 6, on the three pairs of legs; tibial bristles 5, followed by a row of 6—7 much shorter ones at fore tibiae, 4—5 at mid tibiae, and 5—7 at hinder pair of same; tarsal claws without any indication of a subapical tooth.

Wings hyaline, neuration as for genus, but quadrilaterals rather long; proximal and costal sides subequally long in fore wings, but proximal side only about half as long as costal side in hind wings, the costal and distal sides in the latter being subequal in length. Arculus at  $Ax_2$ ; Ac much nearer  $Ax_2$  than  $Ax_1$ ; Ab entering the wing margin a little less than  $1\frac{1}{2}$  times the length of Ac itself beyond it. Three postquadrangular antenodal cells;  $M_3$  arises well before, Rs at the subnodus, base of  $M_3$  normally curved and both veins well separated immediately after their meeting point.  $M_4$  and  $Cu_2$  of normal great length, marginal convexities at end of veins hardly indicated. Fore wing with 16, hinder pair with 15 Px of first series. Pterostigma distinctly oblique, lozenge-shaped but parallel-sided,  $1\frac{1}{4}$  times longer than high; colour deep black finely bordered with yellow. Only a single row of 4—5 cells between C and  $R_1$  posterior to pterostigma.

Abdomen long and slender, from end of segment 6 to base of 10 slightly expanded, the latter parallel-side. Ground colour yellowish, but all tergites with predominantly light brown markings, this colour gradually deepening to dark brown and bronze-black toward end of abdo-

men, 8—10 (except laterally) mostly black. Tergite 1 with diffuse brown dorsal mark broadening toward apex forming an ill-defined dark terminal ring, the sides bright greenish yellow; a complete dark mark also on dorsum of 2, deepest in colour and broadest on basal half but leaving tiny yellow streaks on either side at base, the sides also greenish yellow; dorso-lateral bands on 3—7 suddenly abbreviated in front, so as to save a pair of small yellow spots at the bases of each, the latter being largest on 5—7 and coalescent with distinct citron-yellow lines bordering ventral margin of tergites; 2—6 moreover with fine deep black intersegmental annules restricted to the dorsum, those of 8—10 bright yellow; sides, distal one-third of tergite 10 as well as the vertical mid-caudal process of the latter, ochreous.

Anal appendages (inclusive of the 10th apical plate) ochreous, lower branches of superior appendages and the incurved apices of main branch, black-tipped; inner faces of superiors clothed densely with softish pale pubescence.

Measurements: abdomen + appendages 43 mm; hind wing 27.3 mm.

Male (adult, Small Ngella I.). — This paratype is the 2nd complete ♂ whose characters correspond almost exactly with those of the type, except that there are minute traces only of pruinescence, the thoracic sclerites being wholly deep black with low bronze reflections, save the posterior edges of metepimeron and the post-sternal surface, which are light ochreous. The legs also are coloured as in the type, only the tarsi being obscured.

Size slightly larger: abdomen + appendages 46.0 mm, hind wing 28.4 mm.

Male (adult, incomplete, Big Florida I.). — Quite similar to the last-mentioned male. However, there is an interesting point of difference in its wing venation: the nervure Ac is placed further distad in both hind wings, i.e. at a level only little away from Ax<sub>2</sub> causing the veins Ac and Ab to meet the posterior border of the wing at one point, which is unusual for *Teinobasis*. In all specimens the medio-anal link is entire.

Female unknown.

This new species is distinctly more slenderly built and has a somewhat larger head, than the members of the *T. aluensis* group, though all are of about the same large size. Further peculiari-

ties are found in the structure of the terminal genital organs by which *chionopleura* differs from its congeners in the Solomons. In caudal view, the raised vertical portion of the 10th tergite (fig. 43), does not seem to bear a prolonged median process but is reduced to a short transverse plate hardly visible in dorsal aspect. The black-tipped upcurved and pointed lower branches of the superior appendages are placed inward to a pair of shorter, blunt and pale-coloured, upper branches of the inferior appendages, both of these being well visible in side view (fig. 42), but hidden from view when looked at from above (fig. 41).

*Teinobasis imitans* spec. nov.  
(figs. 30—33)

Material. — Solomon Is.: 1 ♂ (adult holotype), Guadalcanal I., Honiara, 150 m, 2.v.1964, J. Sedlacek (ex BISH, ML). 1 ♀ (adult), Guadalcanal I., Honiara, 17.ix.1965, "at house lights", Roy. Soc. Exped. Brit. Mus. 1966 (BM).

Closely allied to both *T. aluensis* and *simulans* spec. nov.

Male (holotype, adult, abdominal segments 4—7 missing). — Labium, mandible-bases, and genae as far up along orbital lines as base of antennae, obscurely greenish yellow (possibly green or blue in life), mandibles tipped with deep black; labrum bright chrome gradually changing into brown at extreme base, the boundary almost straight but ill-limited. Antennae and postclypeus black with bronze lustre, surface of anteclypeus uneven, of postclypeus finely transversely striated. All the rest of head, inclusive of postocular lobes and occipital ridge, almost lustreless dark bronzy black; transverse frontal crest distinct, subacute; rear of the head, except some diffuse obscuration on inner surface, bright greenish yellow. Antennal sockets somewhat swollen, scape short and thick, pedicel much slenderer, about 1½ times length of scape, both obscurely yellow.

Prothorax dirty ochreous mottled with dark brown on pronotum and centre of pleurae, the anterior lobe suberect, strongly black-rimmed in front; posterior lobe broad, collar shaped, depressed, its hind margin somewhat undulated, the side-edges rounded, whole surface dark metallic green. Synthorax robust, shaped as in *aluensis* and *simulans* spec. nov.; centre of mesostigma lamina and whole mesonotum with the ante-alar triangles, dark metallic green to as



far as the humeral suture, which is indicated by a yellow hair-line; mesepimeron and mesinfraepisternum beyond that level, mainly light blue, the former bearing two distinct patches of dark metallic green of unequal size, separated from each other by the pale ground colour: a diffuse, oblique zone of a more ferruginous tint. Metapleurae similarly coloured but changing to (or mixed with) clear blue upon middle of metepisternum and to yellow further down, the whole ventral surface of thorax also unmarked.

Legs almost entirely yellow, only outer faces of coxae light blue and those of femora slightly more orangish with the knees a shade darker, the yellow at the tibiae conspicuous; femoral bristles robust, brown, 2—4—5, respectively, little shorter than the interspaces; tibial bristles shorter than interspaces, fore tibiae with four longer bristles followed by a row of ca. 10 thinner ones (setae) in outer row, 4—5 strong ones on mid and hind tibiae. Tarsal claws indistinctly toothed: rudimentary or obsolete on all legs.

Wings long, distinctly petiolated as far as *Ac*, much as in *aluensis*, i.e. more markedly broadened than in the smaller-sized regional *Teinobasis*, but again broader than in the close ally *simulans*; venation brown. Arculus at  $Ax_2$  in all wings; position of *Ac* and *Ab* as in the other species: *Ab* entering margin at a point in line with proximal side of quadrilateral, the latter in fore wing only little longer than, in hind wing almost twice as long as, costal side. Medio-anal link entire; three postquadrangular antennal cells.  $M_3$  arises well before,  $Rs$  at the subnodus, the former moderately curved, both veins well separated after their subnodal meeting point.  $M_4$  and  $Cu_2$  of great length, the broken course of  $M_2$  beginning at  $Px_{6-7}$  in fore wings, at  $Px_{8-9}$  in hinder pair, and of  $Cu_2$  at  $Px_{2-3}$ . Fore wing with 16, hind wing with 15  $Px$  of first series. Pterostigma small, oblique, much longer than high, lozenge-shaped but subparallel-sided, braced and much smaller than underlying cell; colour brown narrowly lined with yellow along proximal and costal sides. Between *C* and  $R_1$  posterior to pterostigma 1—2 divided cells about halfway length of space (undivided in right hind wing only).

Abdomen (incomplete), ground colour of tergites 1—2 blue, on succeeding segments dirty ochreous; 1 with complete subtriangular dorsal mark of metallic green pointing basad, sides broadly blue; dorsum of 2 metallic green from base to apex, leaving only a pair of narrow sub-interrupted blue annules at extreme base, the

lower half of sides yellow; dorsum of 3—7 apparently similarly banded, but losing gradually their metallic gloss and becoming broader and darker toward end of abdomen, only at base of 3 a pair of semicircular yellow spots confluent with the pale ground colour at the sides; 8—10 almost wholly black, but intersegmental membranes of 8—9, 9—10 and 10—sup.app., standing out clearly as bright ochreous dorsal annules, the swollen dorsolateral ridge at apex of tergite 10 also yellow.

Anal appendages (figs. 30—32) subequal in length to segment 10, shaped very similar in principle to those of *aluensis*, its synonym *gurneyi*, and *simulans*. Dorsal (main) branch of superior appendages black above and black-tipped, yellow and rather hollowed out within, each provided with tuft of long pale golden hairs (resembling *simulans*); inferior appendages also yellow above and densely light-haired, obscured ventrally.

Female (adult, topotype). — Resembles the male very closely in most respects, differing only in colour design of body and legs, as follows.

Labium, upper mouth-parts, face and frons as well as first two antennal segments, all light ochreous, but at mandibles and genae slightly mixed with olive, the labrum being more brightly orange. Rest of head above dull bronze-black, sharply contrasting with the greenish yellow rear. Antennal pedicel dark-ringed apically, the distalia black.

Prothorax (fig. 33), reddish ochreous, margins of posterior lobe obscured, the latter hardly raised; laminae mesostigiales transverse, carrying light brown, erect, ear-like lobes. Synthorax much as in male, bronze-green dorsally to just before humeral suture, the suture itself pale, the bronzy tint including ante-alar triangles, mid-ventral and axillary sclerites; colour at sides and underneath, all dirty ochreous. Brownish patch upon shoulder area (mesepimeron) very diffuse, with slight metallic green gloss.

Legs totally yellow save outer faces of coxae blue and those of femora orangish, armature as in male. Claws with rudiment only of an inner subapical tooth. Wings well petiolated, with brown neuration; medio-anal link entire though slightly fractured in left hind wing. Wing tips relatively obtuse; all wings with 15  $Px$  of first series. Pterostigma as in male, light brown surrounded by yellow; area between *C* and  $R_1$  distal to pterostigma exactly as in male.

Abdomen yellow-brown gradually darkening



toward end; tergites 2—7 indistinctly obscured apically, 3—8 moreover with very narrow ill-defined yellowish basal rings interrupted by the yellow-brown dorsal colouring; intersegmental membranes dark, except those between 7—8 and 8—9, yellow; tergites 8—10 metallic greenish black, the lower half of sides pale. Genital valves not surpassing apex of segment 10, carrying a row of minute, blunt marginal serrulations; cerci obscured, shorter than segment 10, divergent, pyramidal, tips acute.

Measurements: ♂ abdomen + appendages 47 mm (approx.), hind wing 31.5 mm; ♀ abd. 46.0 mm, hind wing 32.6 mm, pterostigma 0.6 mm.

This is probably the closest relative of *aluensis*. Apart from minor colour features of less importance, male *imitans* differs from *aluensis* in the following points: (1), the whole posterior surface of the vertical process (or "breech-block"), at the apex of the 10th tergite, is deep black (bright yellow in *aluensis*); (2), the outer faces of the main (upper) branch of the sup. app. and their lower branches as well, are also black, the latter being very shiny; (3), the appendages are longer and more slender, less hollowed out within, than in *aluensis*; (4) the inf. apps. of *imitans* are obscured ventrally but yellow on the inside and clothed densely with pale pubescence, the tip with the long fringe of pale golden hairs directed inward (only partly shown in fig. 31). In both species the median process of the 10th tergite is broad and somewhat flattened when viewed from above, but strongly hooked and downcurved in profile view (cf. figs. 30 and 31).

#### *Teinobasis bradleyi* Kimmins (figs. 34—36, 40)

*Teinobasis bradleyi* Kimmins, 1957: 315—316, tfigs. 2 A—C (♂ thorax & anal apps.). — ♂ Guadalcanal I.; Kimmins, 1970: 183 (♂ lectotype selected).

Material. — Solomon Is.: 2 ♂ (adult, one imperfect), Guadalcanal I., Tapenanje, 10—23.xii.1953, lectotype and paralectotype (BM). — 2 ♂ (adult), Malaita I., Ngwaiu, 1500 ft., 10.x.1967, "in forest", R. Sloof (ML). — 1 ♂ (adult), Santa Ysabel I., Maring dist., Te natahi, 2.vii.1960, C. W. O'Brien (ex BISH, ML). — 1 ♂ (adult), Bougainville I., Buin, 2.i.1970, R. Straatman (ML); 2 ♂, 1 ♀ (adult), Bougainville I., Buin town, 15—16.v.1975, "along small stream", H. R. Wimmer (USNM), and Bougainville I., 16.xi.1944, "ex jungle by stream" (one pair), A. B. Gurney (USNM); 1 ♀ (juvenile, red), Bougainville I., Buin, 4.vi.1956, J. L. Gressitt (BISH).

Male (adult, Tapenanje). — The following colour and structural notes are additional to those given for the lectotype, subsequently selected by Kimmins for one of his specimens from Guadalcanal.

Differs from *T. obtusilingua* spec. nov.: anterior margin of labrum more broadly bordered with chrome. Face and frons in front, bright blue. Thoracic pattern wholly different, as shown by Kimmins (loc. cit., tfig. 2 A) and in our fig. 40. Inner faces of sup. anal app. beset along whole length with long pale hairs (in *obtusilingua* only at apices); appendages very similar in the two, but mid-apical process of tergite 10 broader and tapering to a blunt point, deep black, as shown in fig. 34 (see also Kimmin's tfig. 2 C). From *T. aluensis*, the present species differs in that the vein  $M_3$  arises before, and Rs at the subnodus, but this character may be unstable; *aluensis* is also a somewhat more robustly built and larger species than *bradleyi*, the type of the latter measuring abdomen + appendages 39 mm, hind wing 26 mm. The "slight undulations of the wing apices", mentioned by Kimmins, apply to the prominent posterior border at the end of the main veins, not to the apical undulations, as seen in a number of regional platycnemidids.

Female. — No insular topotypes are available.

Close comparisons made between typical *bradleyi* from Guadalcanal and all specimens collected in the island chain of Malaita, Santa Ysabel, and Bougainville, have led to the conclusion that all these populations belong to a single species which, accordingly, seems to have a much wider distribution than was thought at the outset of this investigation. All agree in their wing venation, the scheme of coloration, and their genital structure, only the body size and details of colour having been noticed. The next descriptions and drawings are based on the best preserved and fully mature specimens from Bougainville, which also include a well-coloured female from that most westerly situated island of the chain.

Male (adult, Bougainville). — Labium palest yellow, labrum glossy black, the anterior border, except laterally, yellow, a vestige of a yellow spot also on either side at extreme base; mandible-bases light blue, the distal one-third brownish black; anteclypeus light blue, postcly-

peus glossy black; entire genal area and antefrons as far as the transverse ridge and insertion point of antennae light blue, this colour extending posteriorly all along orbital margin to beyond base of maxillae; remainder of frons and all the rest of head including the occiput, black. Frons and ocellar area with low bronze reflex, behind which the interocular and occipital region with more distinct dark metallic green lustre. A tiny oblique yellow spot just visible between antenna and lateral ocellus. Occipital lobes slightly pruinose blue, an oval patch of blue pruinescence placed more rearward also upon centre of occiput. Cervix yellow.

Whole dorsum of prothorax black with slight bronze sheen, the sides light blue; pronotal tubercles low, evenly convex; posterior lobe simple, rather crescent-shaped, surface convex and directed straight back, about twice as long as the side lobes, which are rounded off; whole border evenly rounded, hardly swollen or upturned.

Dorsum and upper part of sides of synthorax, black, as shown in fig. 40, for the rest all vivid light blue, as described for the type by Kimmins (1957, fig. 2 A). All dorsal ridges and humeral suture with the exception of a vestigial spot of blue at either end of the latter (one to the inside, the second at the dorsal ridge of suture), likewise black; inner portions of black mesepisterna with distinct metallic green lustre, the remainder deep black; a sharply contrasting brown hair line laterally, and a pair of posterior dark spots on the poststernum.

Coxae and trochanters of legs blue; femora pale greenish blue with complete, thick, dark brown exterior stripe broadening to an apical ring at the knees; tibiae yellow-brown tipped with ochreous; tarsi bright orange-chrome. All spines and bristles black; femoral bristles as long as the interspaces, 3, 4, 4, respectively; tibial bristles longer, also equalling interspaces, 5, 4, 5, respectively; tarsal claws lacking an inferior tooth, the tips obscured.

Wings narrow, neurulation much as in all other regional congeners; membrane hyaline, veins black. Ac situated much nearer  $Ax_2$  than  $Ax_1$ , only half as long as its distance from the quadrilateral, which is slightly less than twice as long as Ac itself; Ab enters the margin well distal to Ac, for fully twice the length of Ac. Arculus at  $Ax_2$  in fore wings, very little beyond that level in hinder pair. Quadrilateral of fore wing with proximal side little shorter than costal side, in hind wing costal side markedly longer, twice as long as proximal side and subequal to distal

side. Medio-anal link entire; three postquadragular antenodal cells.  $M_3$  and Rs closely approximated at origin, base of  $M_3$  but little curved, arising slightly before, Rs slightly after the subnodus, both veins well separated distal to their meeting point. Broken course of  $M_4$  and  $Cu_2$  dissimilar: fractured portion of  $M_4$  beginning far distad, i.e. at level of  $Px_{10}$  in both pairs of wings, of  $Cu_2$  at level of  $Px_3$ , both portions in the latter subequally long. Fore wing with 13—14, hind wing with 13 Px of first series. Pterostigma small, almost twice as long as high, oblique but almost parallel-sided, surmounting exactly one much larger cell; colour brownish black, costal and anal sides bordered with extremely fine pale hair-line.

Abdomen very thin and slender, basal segments more expanded than terminal ones; sides of tergites 1—2 largely blue, dorsum of both with complete metallic greenish black band broadening markedly toward end though, after a subapical constriction, forming almost complete dark terminal annules, the intersegmental membrane 1—2 blue; dorsum and most of the tergal sides 3—7 occupied by well defined bronze-black marks from base to apex, leaving only vestigial paired yellowish spots at extreme base, the dark bands broadening somewhat posteriorly, the rest of the tergites bright ochreous in colour. Tergite 8 with the dorso-lateral mark hardly broadening posteriorly, on 9 almost straight-lined, and the one on 10 leaving only a triangular spot along lower border. All intersegmental membranes dorsally as well as the sternites, bright chrome yellow. Configuration of 10th tergite and anal appendages as in figs. 34—36, colour black or almost so, only inner shelves of main branch of inferior appendages yellowish, the hairs fringing inner faces and apices of upper branch of superior appendages distinctly white.

Female (adult, Bougainville). — This was collected simultaneously with the male and corresponds closely with the latter in stature and venation. Here follows a comparative description.

Labium bright yellow. Labrum black only at middle along base, all the rest of it vivid orange. Anteclypeus obscured, dullish; postclypeus contrastingly deep glossy black, except laterally and on the mandible-bases which are coloured a dirty greenish ochreous, yet acquiring a more vividly green tint on the genal area and forming a broad colour band also on the antefrons as far up as the antennal sockets and frontal ridge;



first antennal segments partly obscured. Whole upper surface of head dark metallic green, much less shiny than the black postclypeus, light marks restricted to a pair of tiny oblique specks placed about midway between lateral ocelli and antennae; a thick transverse bar upon the occipital plate at some distance behind lateral ocelli, also pale. Rear of the head deep black, the pale genal area extending upward along eye-border as far as base of labial hinge, the black area thinly pruinose.

Prothorax ferruginous brown, its sides overlaid with bluish pruinescence; posterior lobe larger and more raised than in male, median portion dome-shaped in caudal view, its border broadened a little on either side of middle to form slightly forwardly curved, rounded lobes, which are convex anteriorly, hollowed out posteriorly. Synthorax marked exactly as in male, except that the dorsolateral parts are ferruginous instead of black, only the middorsal carina and a complete parallel-sided band attached to it on either side, metallic green, this median band almost equal in width to each of the mesepisternal (antehumeral) halves; remainder of thoracic sides as well as the ventral surface throughout pale blue, slightly pruinose lower down. Legs coloured as in male, i.e. vivid light chrome, the bases of all coxae blue, a complete though narrow black stripe at outer faces of all femora, these stripes broadening at end to form distinct apical annules; bristles black. Shape of wings and venation as in male, the relatively long pterostigma light brown finely surrounded with yellow. Px of first series 15 in fore wings, 13 in hind pair.

Abdomen comparatively slender, the terminal segments but little expanded. Ground colour greenish yellow, all segments marked with bronze-green dorsal bands, complete on tergites 1—2, both broadening toward end, those on 3—7 more abruptly narrowed basally and expanded apically, the small yellow basal annules finely interrupted in the median line; colour of apical tergites obscured, broadly yellow at sides. Genital valves darkened, surpassing tuberculum anale and cerci for about half length of segment 10, yellow-tipped; cerci pricker-shaped, yellow.

Measurements: abdomen (incl. valves) 35.5, hind wing 25.0, pterostigma 1.0 mm.

Female (juvenile, red colour phase). — Ground colour of whole body bright orange-pink; dark markings much as in male, differing as follows. Labrum wholly pale save for a deep

black midbasal spot; front of face likewise, except postclypeus deep black. Dorsum of prothorax with a fine X-shaped black mark and a median spot at extreme base of its posterior lobe, the latter shaped much as in the adult, but side-lobes more rounded. Synthorax with the metallic green dorsal band a little narrower, standing out clearly on either side of the median carina, which remains orange, as also the antalar triangles. Abdomen as in the adult female, but end segments 9—10 for the greater part orange.

#### [REFERENCES]

- Brauer, F., 1868. Dritter Bericht über die von Herrn G. Semper mitgeteilten, von dessen Bruder auf den Philippinen gesammelten Neuropteren und Beschreibung einer neuen Libellen-Gattung aus dem Museum Godeffroy in Hamburg. — Verhandlungen der K. K. zoologisch-botanischen Gesellschaft in Wien 18: 541—558.
- Campion, H., 1924. Descriptions of two new species of *Teinobasis* (Odonata). — Annals and Magazine of Natural History 9 (14): 612—614.
- Davies, D. A. L., & P. Tobin, 1984. The dragonflies of the world: A systematic list of the extant species of Odonata. Volume 1. Zygoptera, Anisozygoptera. — Rapid Communications Societas Internationalis Odonatologica, Suppl. 3: i—ix, 1—127.
- Kimmins, D. E., 1934. A note on two species of *Teinobasis* (Odonata) described by the late Herbert Campion. — The Entomologist 67: 197.
- Kimmins, D. E., 1957. Odonata collected by Mr. J. D. Bradley on Guadalcanal Island, 1953-54. — Bulletin of the British Museum (Natural History), series Entomology 5: 309-320.
- Kimmins, D. E., 1970. A list of the type-specimens of Odonata in the British Museum (Natural History). Part III. — Bulletin of the British Museum (Natural History), series Entomology 24: 173—205.
- Lieftinck, M. A., 1932. The dragonflies (Odonata) of New Guinea and neighbouring islands. I. Descriptions of new genera and species of the families Lestidae and Agrionidae. — Nova Guinea 15: 485-602.
- Lieftinck, M. A., 1935. The dragonflies (Odonata) of New Guinea and neighbouring islands. III. Descriptions of new and little known species of the families Megapodagrionidae, Agrionidae and Libellulidae (genera *Podopteryx*, *Argiolestes*, *Papua-grion*, *Teinobasis*, *Huonia*, *Synthemis* and *Procordulia*). — Nova Guinea 17 (Zool.): 203—300.
- Lieftinck, M. A., 1937. The dragonflies (Odonata) of New Guinea and neighbouring islands. IV. Descriptions of new and little known species of the families Agrionidae (sens. lat.), Libellulidae and Aeshnidae (genera *Idiocnemis*, *Notoneura*, *Papua-*



*grion*, *Teinobasis*, *Aciagrion*, *Bironides*, *Agyrtacantha*, *Plattycantha*, and *Oraeschna*). — *Nova Guinea* (N. S.) 1: 1—82.

- Lieftinck, M. A., 1938. The dragonflies (Odonata) of New Guinea and neighbouring islands. V. Descriptions of new and little known species of the families Libellaginidae, Megapodagrionidae, Agrionidae (sens. lat.), and Libellulidae (genera *Rhinocypha*, *Argiolestes*, *Drepanosticta*, *Notoneura*, *Palaiargia*, *Papuargia*, *Papuargion*, *Teinobasis*, *Nannophlebia*, *Synthemis*, and *Anacordulia*). — *Nova Guinea* (N.S.) 2: 47—128.
- Lieftinck, M. A., 1949. Synopsis of the odonate fauna of the Bismarck Archipelago and the Solomon Islands. — *Treubia* 20: 319—374.
- Lieftinck, M. A., 1953. Additions to the odonate fauna of the Indo-Australian Archipelago. — *Treubia* 22: 233—269.
- Lieftinck, M. A., 1957. On some old types of coenagrionine Odonata described from the Philippine Islands, with notes on allied species. — *Zoologische Mededelingen, Leiden* 35: 161—175.
- Lieftinck, M. A., 1962. Odonata. — *Insects of Micronesia* 5 (1): 1—95.
- Lieftinck, M. A., 1963. Contributions to the odonate fauna of the Solomon Islands, with notes on zygopterous larvae. — *Nova Guinea* (Zool.) 21: 523—542, 1 plate.
- Needham, J. G., & M. K. Gyger, 1939. The Odonata of the Philippines, II. Suborder Zygoptera. — *The Philippine Journal of Science* 70: 239—314, plates 11—22.
- Selys Longchamps, E. de, 1877. Synopsis des Agriornines. 5me légion: *Agriorn* (suite et fin). — *Bulletin de l'Académie Royale de Belgique serie 2*, 43 (2): 97—159 (separate p. 1—65).



## TIJDSCHRIFT VOOR ENTOMOLOGIE

UITGEGEVEN DOOR

DE NEDERLANDSE ENTOMOLOGISCHE VERENIGING

## REGISTER VAN DEEL 129

\* Een sterretje duidt een naam aan die nieuw is voor de wetenschap; cursieve paginanummers verwijzen naar de beschrijvingen van nieuwe taxa.

\* An asterisk denotes a name new to science; numbers in italics refer to descriptions of new taxa.

## ACARI

aesculi, *Neophyllobius* 191  
 agrifoliae, *Neophyllobius* 191,  
 [201  
 australis, *Camerobia* 191, 192,  
 [195, 196, 198, 199  
*Camerobia* 191, 192, 194, 195,  
 [201  
 citri, *Neophyllobius* 191, 201  
 \*Decaphyllobius 191, 192, 194,  
 [195, 201  
 elegans, *Neophyllobius* 214  
 floridensis, *Neophyllobius* 191,  
 [205  
 floridensis, *Tillandsobius* 207,  
 [209  
 \*gersoni, *Decaphyllobius* 191, 192,  
 [200, 201, 202-204  
 hadros, *Neophyllobius* 191, 201,  
 [202  
 hirtus, *Ixodiphagus* 183  
 hookeri, *Ixodiphagus* 181, 182  
 Hunterellus 181, 183  
*Ixodiphagus* 181, 183  
 lombardini, *Neophyllobius* 191,  
 [205, 206  
 lombardini, *Tycherobius* 206-  
 [208, 210  
 \*monspeliensis, *Camerobia* 191,  
 [195, 199, 201  
*Neophyllobius* 191-195, 214  
 Obdulia 201  
 \*pistaciae, *Camerobia* 191, 195,  
 [196, 198, 199  
 \*polonicus, *Tycherobius* 191, 206,  
 [207, 208, 212  
 rhytis, *Neophyllobius* 191, 205,  
 [214  
 rhytis, *Tycherobius* 206  
 southcotti, *Camerobia* 191, 195,  
 [198, 201  
 \*stramenticola, *Tycherobius* 191,  
 [206, 207, 208, 211  
 superbus, *Neophyllobius* 191,  
 [206, 208

superbus, *Tycherobius* 206-208  
 texanus, *Ixodiphagus* 181-183  
 theilerae, *Ixodiphagus* 181  
 \**Tillandsobius* 191, 194, 195, 205  
 \**Tycherobius* 191, 194, 195, 205,  
 [208, 214  
 virginiensis, *Neophyllobius* 191,  
 [208  
 virginiensis, *Tycherobius* 205,  
 [206, 208, 213

## ARANEAE

cornutus, *Araneus* 17

## COLEOPTERA

*Anthrenus* 243  
 carcharias, *Saperda* 17  
*Cetonia* 77, 98, 104  
*Geotrupes* 98, 104  
 violaceum, *Callidium* 17

## DICTYOPTERA

nigra, *Ostrava* 107, 109  
 wolfforum, *Mazonoptera* 107

## DIPTERA

acerba, *Angioneura* 20, 21  
*Acompominto* 23, 27, 29, 30  
 aculeata, *Nephrotoma* 2  
 acuminata, *Tipula* 11  
*Acutipala* 2, 6  
 alpina, *Tipula* 4  
 alpium, *Tipula* 3  
 analis, *Nephrotoma* 2  
*Angioneura* 15, 20, 21, 23, 27  
 angustifrons, *Phyto* 17, 23, 18,  
 [25, 26  
 angustifrons, *Stevenia* 23,  
 angustifrons, *Tromodesia* 23, 25,  
 [26  
 anicilla, *Tipula* 6  
 animula, *Tipula* 6  
*Anoplisa* 30  
 anthe, *Tipula* 7  
 antichasia, *Tipula* 6

aphrodite, *Tipula* 7  
 appendiculata, *Nephrotoma* 2  
 argyriiventris, *Bequaertiana*, 23,  
 [25  
 ariadne, *Tipula* 7  
 artemis, *Tipula* 7  
 asetosa, *Melanophora* 24, 32  
 aspromontensis, *Tipula* 4  
 aterrima, *Oplissa* 23, 24, 30, 31  
 atramentaria, *Stevenia* 17, 19, 23,  
 [31

atrata, *Tanyptera* 2  
 austriaca, *Tipula* 4  
*Azaisia* 23, 27, 29, 30, 32  
 balcanica, *Tipula maxima* 2, 5  
 Baniassa 18, 20, 23, 25-27, 32  
 basilewskyi, *Bequaertiana* 23  
 benesignata, *Tipula* 4  
 Bengalia 16, 22  
*Bequaertiana* 17, 23, 24, 26, 32  
 Beringotipula 2  
 betulae, *Semudobia* 125, 128,  
 [132, 133, 136-140

*Bezzimyia* 20  
 bifasciculata, *Tipula* 7  
 bimacula, *Tipula* 5, 7, 9, 12  
 bimaculata, *Dictenidia* 2  
 bispina, *Tipula* 6  
 borystenica, *Tipula* 7  
 brevicornis, *Paykullia* 23  
 brevipalpis, *Semudobia* 126, 130,  
 [131, 135  
 brunneinervis, *Tipula* 5, 7, 11  
 bulbosa, *Tipula* 7  
 caesia, *Tipula* 3  
*Callidesia* 23, 25, 26  
*Calliphora* 77, 98  
*Calobataemyia* 22  
 capensis, *Melanomyoides* 23,  
 [27-29, 32  
 capensis, *Rhinomorinia* 23  
 capreola, *Tipula* 6  
 carbonaria, *Metoplisia* 23, 30-32  
 carpatica, *Tipula excisa* 4



- cassiope, *Tipula* 6  
 caudatula, *Tipula* 6  
 caudispina caudispina, *Tipula* 6  
 caudispina parnonensis, *Tipula* 6  
*Chaetostevenia* 27  
 cheethami, *Tipula* 4  
 ciconia, *Tipula truncata* 6  
 cilicrus, *Clinodiplosis*, 125  
 cinerascens, *Tipula* 6  
 cinerella, *Tipula* 7  
 cingulata, *Phyto* 23  
 circumdata, *Tipula* 4  
*Cirillia* 15, 17, 22, 23, 27  
*Clinodiplosis* 126  
 clio, *Tipula* 6, 10  
 coeruleascens, *Tipula*  
     *latemarginata* 3  
*Comoromyia* 23, 30  
*congolensis*, *Parazamimus* 23, 26,  
     [32  
*conspurcata*, *Helicella* 17  
*cornicina*, *Nephrotoma* 2  
*couckeii*, *Tipula* 3  
*crassiventris*, *Tipula* 4  
*cretis*, *Tipula* 5, 7  
*crocata*, *Nephrotoma* 2  
*croceiventris*, *Nephrotoma* 2  
*Ctenophora* 2  
*cyrtoneurina*, *Angioneura* 20, 21  
 danieli, *Tipula* 6  
*Dasineura* 125, 126, 136, 139  
*deceptorica*, *Stevenia* 23  
*decipiens*, *Tipula* 3  
*decolor*, *Tipula* 7  
*Dendrotipula* 2  
*Dictenidia* 2  
*discrepans*, *Phyto* 17, 21, 23  
*Dolichozepea* 4  
*dorsalis*, *Nephrotoma* 2  
*elegans*, *Ctenophora* 2  
*eleonorae*, *Tipula* 4  
*Emodotipula* 4  
*engeli*, *Tipula* 5, 7  
*erato*, *Tipula* 7  
*errans*, *Tipula italica* 5, 7, 9  
*euchroma*, *Nephrotoma* 6  
*eugeniana*, *Tipula* 6  
*eurykleia*, *Tipula penelope* 6  
*euterpe*, *Tipula* 6  
*excisa carpatica*, *Tipula* 4  
*excisa excisa*, *Tipula* 4  
*fascicula*, *Tipula* 6  
*fascingulata*, *Tipula* 4, 10  
*fascipennis*, *Baniassa* 23, 25, 27  
*fascipennis*, *Tipula* 2  
*fastidiosa*, *Dasineura* 136, 137  
*fastuosa*, *Ctenophora* 2, 3  
*fernandezi*, *Stevenia* 23  
*fimbriata*, *Angioneura* 21  
*festiva*, *Ctenophora* 2  
*flaveolata*, *Ctenophora* 2  
*flavescens*, *Nephrotoma* 2  
*flavipalpis*, *Nephrotoma* 2  
*flavipes*, *Queximyia* 23, 28, 32  
*flavolineata*, *Tipula* 2  
*fulvipennis*, *Tipula* 2  
*furcula*, *Tipula* 7  
*fuscicosta*, *Tipula* 7  
*fuscipes*, *Dolichozepea* 4  
*gimmerthali*, *Tipula* 4  
*glacialis*, *Tipula* 4  
*goriziensis*, *Tipula* 4  
*graeca*, *Dolichozepea* 4  
*graeocolivida*, *Tipula* 7  
*griseithorax*, *Comoromyia* 23, 30,  
     [32  
     *grisescens*, *Tipula* 4  
     *guestfalica*, *Nephrotoma* 2  
     *guttata*, *Ctenophora* 2  
     *harmonia*, *Tipula* 6  
     *helicivora*, *Melanophora* 17  
     *helvola*, *Tipula* 2  
     *hemiptera*, *Tipula strobliana* 4  
     *hera*, *Tipula* 6  
     *heros*, *Tipula* 7  
     *hertingi*, *Phyto* 27  
     *hirtigena*, *Stevenia* 23, 30  
     *Hoplisa* 30  
     *hortorum*, *Tipula* 3  
     *invenusta subinvenusta*, *Tipula* 4  
     *interbracta*, *Dasineura* 130, 136,  
     [137  
     *interserta*, *Tipula* 4  
     *irrorata*, *Tipula* 3  
     *ismene*, *Tipula* 6  
     *istriana*, *Tipula* 7  
     *italica errans*, *Tipula* 5, 7, 9  
     *jeekeli*, *Tipula* 4  
     *jordansi*, *Tipula pannonia* 7  
     *klytaimnestra*, *Tipula* 6  
     *kugleri*, *Paykullia* 23  
     *laetabilis*, *Tipula* 4  
     *lanispina*, *Tipula* 6  
     *latemarginata coeruleascens*,  
         *Tipula* 3  
     *lateralis*, *Tipula* 3  
     *latifurca*, *Tipula transcaucasica* 6  
     *leandros*, *Tipula* 7, 10  
     *leda*, *Tipula* 6  
     *lepida*, *Rhinophora* 17, 23, 26,  
         [28, 32  
     *Lestodiplosis* 126  
     *leto*, *Tipula* 6  
     *limbata*, *Tipula* 4  
     *limitata*, *Tipula* 4  
     *livida*, *Tipula* 2, 11  
     *lobata*, *Acompomintho* 23, 29, 32  
     *longimana*, *Macrotrarsina* 23, 29,  
         [32  
     *luna*, *Tipula* 2  
     *lunata*, *Tipula* 2, 11  
     *Lunatipula* 2, 4-6, 8-12  
     *lunulicornis*, *Nephrotoma* 2  
     *luridorostris*, *Tipula* 4  
     *luteipennis*, *Tipula* 3  
     *macropeliostigma*, *Tipula* 7  
     *macroseleene macroseleene*, *Tipula*  
         [7, 11  
     *macroseleene pan*, *Tipula* 7  
     *Macrotrarsina* 23, 29, 30  
     *maculata*, *Paykullia* 17, 23, 25  
     *marginella*, *Tipula* 3  
     *marshalli*, *Termitoloemus* 22  
     *maxima balcanica*, *Tipula* 2, 5  
     *mayerduerii*, *Tipula* 4  
     *Mediotipula* 4  
     *mediterranea*, *Tipula* 5, 7  
     *melanocephala*, *Phyto* 17, 23, 26  
     *Melanonya* 15, 21, 22  
     *Melanomyoides* 23, 27, 29  
     *Melanophora* 17, 18, 20, 23, 24  
     *melanoptera*, *Morinia* 21, 22  
     *mellea*, *Tipula* 2  
     *melpomene*, *Tipula* 6  
     *Metopisena* 23  
     *Metoplis* 23, 29, 30  
     *milichioides*, *Ventrops* 23, 27, 28  
     *monstrabilis*, *Tipula* 7  
     *montana*, *Tipula* 4  
     *montium*, *Tipula* 3  
     *Morinia* 15, 22  
     *nana*, *Melanomyia* 21  
     *nausicaa*, *Tipula* 7  
     *Nephrotoma* 2, 4, 6  
     *neurotica*, *Tipula* 4  
     *nigerrima*, *Morinia* 22  
     *nigra*, *Nigrotipula* 2  
     *nigricornis*, *Tanyptera* 2  
     *Nigrotipula* 2  
     *nodicornis*, *Tipula* 3  
     *nubeculosa*, *Tipula* 3  
     *Nyctia* 22  
     *obscura*, *Angioneura* 20, 21  
     *obscura*, *Azaisia* 23, 29  
     *obsoleta*, *Tipula* 3  
     *Odonatisca* 3  
     *oldenbergi*, *Oplisa* 30  
     *oleracea*, *Tipula* 3  
     *onusta*, *Tipula* 7  
     *Oplisa* 23, 29, 30, 32  
     *Opsedoxa* 20  
     *orientalis*, *Tipula* 5, 7  
     *ornata*, *Ctenophora* 2  
     *pabulina*, *Tipula* 3

- pachyprocta*, *Tipula* 7  
*pallidicosta*, *Tipula* 4  
*paludosa*, *Tipula* 3  
*pan*, *Tipula macroselene* 7  
*pandorra*, *Tipula* 7  
*pannonia jordansi*, *Tipula* 7  
*pannonia pannonia*, *Tipula* 7  
*Parazamimus* 20, 23, 24, 26, 27  
*parnionensis*, *Tipula caudispina* 6  
*paucipila*, *Baniassa* 23, 26  
*pauciseta*, *Phyto* 23, 25  
*Paykullia*, 17-20, 23, 24, 26, 27, [32  
*pectinicornis*, *Ctenophora* 2  
*pelidne*, *Tipula* 7  
*peliosigma*, *Tipula* 3, 11  
*penelope eurykleia*, *Tipula* 6  
*penelope penelope*, *Tipula* 6  
*Phyto* 15, 17-20, 22, 23, 26, 27, [30, 32  
*pictipennis*, *Callidesia* 23, 25, 32  
*pierrei*, *Tipula* 3  
*pinnifer*, *Tipula* 6  
*Platytipula* 3  
*plitviciensis*, *Tipula* 4  
*pollinosa*, *Oplisa* 23, 30  
*polydeukes*, *Tipula* 6  
*praecox*, *Tipula* 6  
*pratensis*, *Nephrotoma* 2  
*prodrassi*, *Tipula* 4  
*pruinosa*, *Tipula* 3  
*pseudoirrorata*, *Tipula* 4  
*pseudopruinosa*, *Tipula* 4  
*pseudovariipennis*, *Tipula* 3  
*Pterelachisus* 3, 4  
*pythia*, *Tipula* 6  
*quadrifaria*, *Nephrotoma* 2  
*quadristriata*, *Nephrotoma* 2  
*Queximya* 23, 27, 29  
*Rhinomorinia* 22, 23, 26, 27, 29, [32  
*Rhinophora* 17, 18, 23, 27, 29  
*riedeli*, *Tipula* 7  
*roralis*, *Melanophora* 17, 21, [23-25, 32  
*rubricosa*, *Tricogena* 17, 23, 31, [32  
*rufina*, *Tipula* 3  
*rufula*, *Tipula* 6  
*saginata*, *Tipula* 4, 5  
*sarajevensis*, *Tipula* 4  
*Sarcophaga* 19  
*sarcophagina*, *Rhinomorinia* 17, [23, 26, 28  
*Savtshenkia* 3, 4  
*savtshenkoi*, *Tipula* 7  
*scalaris*, *Nephrotoma* 2  
*schmidti*, *Tipula* 6  
*Schummelia* 3, 4  
*scripta*, *Tipula* 3  
*scurra*, *Nephrotoma* 2  
*seguyi*, *Tipula* 6  
*selene*, *Tipula* 3  
*Semudobia* 125, 132, 133, 135, [136, 139, 140  
*setitarsis*, *Azaisia* 23  
*Shannoniella* 20  
*siebkei*, *Tipula* 4  
*sigma*, *Tipula* 6  
*simulans*, *Tipula* 4  
*Siphona* 16  
*skuhravae*, *Semudobia* 126, 128, [132, 136-140  
*soosi*, *Tipula* 5, 7, 9, 12  
*Stevenia* 17, 18, 22, 23, 26, 27, [29, 30, 32  
*stigmatella*, *Tipula* 4  
*strobliana hemiptera*, *Tipula* 4  
*strobliana strobliana*, *Tipula* 4  
*stubbsi*, *Tipula* 3, 5  
*subcunctans*, *Tipula* 3  
*subinvenusta*, *Tipula invenusta* 4  
*submaculosa*, *Nephrotoma* 2  
*submarmorata*, *Tipula* 3  
*submontium*, *Tipula* 3  
*subnodicornis*, *Tipula* 4  
*subsignata*, *Tipula* 4  
*subtrunca*, *Tipula* 6  
*subtrunca*, *Tipula* 6  
*Tanyptera* 2  
*tarda*, *Semudobia* 126, 128, 132, [133, 136-140  
*tenuicornis*, *Tipula* 2  
*tenuipes*, *Nephrotoma* 4  
*tergestina*, *Oplisa* 23, 30  
*Termitoloemus*, 15, 22  
*thais*, *Tipula* 6  
*theia*, *Tipula* 6  
*tibonella*, *Tipula* 7  
*Tipula* 2-4  
*titania*, *Tipula* 6  
*transcaucasica latifurca*, *Tipula* 6  
*Tricogena* 17, 18, 23, 26, 29, 30  
*Tromodesia* 23, 25-27, 32  
*trunca*, *Tipula* 6  
*truncata ciconia*, *Tipula* 6  
*truncata truncata*, *Tipula* 6, 10  
*truncorum*, *Tipula* 3  
*tyche*, *Tipula* 6  
*umbratica*, *Stevenia* 17, 23  
*unca*, *Tipula* 2  
*urania*, *Tipula* 7  
*variicornis*, *Tipula* 3  
*varipennis*, *Tipula* 3  
*Ventrops*, 23, 27, 32  
*vernalis*, *Tipula* 3, 5  
*Vestiplex* 3, 4  
*vibripenis*, *Tromodesia* 25  
*vittata*, *Tipula* 2  
*vogtenhuberi*, *Tipula* 7  
*vorax*, *Lestodiplosis* 125  
*wewalkai*, *Tipula* 7  
*wolfi*, *Tipula* 7  
*xanthocephala*, *Rhinomorinia* 23, [28  
*Yamatotipula* 3, 7  
*zonaria*, *Tipula* 4  
**EPEHEMEROPTERA**  
*Caenis* 88  
*Ephemera* 81, 87  
*Oligoneuriella* 88  
*Ostrava* 109  
**HOMOPTERA**  
*\*brendelli*, *Lembeja* 141, 142, 146, [147, 176, 178-180  
*\*dekkeri*, *Lembeja* 141, 142, [145-147, 150, 155-158, 173  
*\*distanti*, *Lembeja* 141, 142, 145- [147, 170, 173, 174, 175, 178, 180  
*\*elongata*, *Lembeja* 141, 142, 144, [146, 147, 150, 153-155, 157, [158, 173  
*faticina*, *Prasia* 141  
*fatiloqua*, *Lembeja* 141, 142  
*foliata*, *Cephaloxys* 141, 149, 150  
*foliata*, *Lembeja* 141-147, [149-151, 153, 158, 160, 162, [166, 170, 171, 173, 174  
*foliata*, *Prasia* 149  
*fruhstorferi*, *Lembeja* 141, 142, [158  
*harderi*, *Lembeja* 141, 149  
*\*hollowayi*, *Lembeja* 141, 142, 146, 148, 162-164, 166, 173, 177  
*\*incisa*, *Lembeja* 141, 142, 146, 148, 158, 166, 170, 171-173  
*Iruana* 142  
*Lembeja* 141, 142, 158  
*maculosa*, *Lembeja* 141, 142, 160  
*maculosa*, *Perissoneura* 178  
*\*majuscula*, *Lembeja* 141, 142, [144, 146, 148, 169, 170, [171, 173, 179  
*\*minahassae*, *Lembeja* 141, 142, [145-147, 150, 151-153, [158, 173, 177  
*\*mirandae*, *Lembeja*, 141, 142, [145, 146, 148, 166-168, 170-173  
*\*oligorhanta*, *Lembeja* 141, 142, [146, 148, 158, 164-166, 173  
*papuensis*, *Lembeja* 141, 142  
*paradoxa*, *Lembeja* 141, 142

- \*pectinulata, Lembeja 141, 142,  
[144, 146, 148, 158-160, 162, 173  
Perissoneura 141  
Prasia 141, 150  
robusta, Lembeja 141, 142  
roehli, Lembeja 141, 142  
\*sanguihensis, Lembeja 141, 142,  
[146, 148, 149, 160-162  
sanguinolenta, Lembeja 141, 142,  
[178  
tincta, Lembeja, 142  
tincta, Prasia, 142  
typica, Jacatra 143, 160  
vitticollis, Lembeja 142  
vitticollis, Prasia 141
- HYMENOPTERA**  
affinis, Pelopoeus 254  
affinis, Sphex 254  
Apis 77  
atripes, Pelopoeus 240  
atripes, Sceliphron deforme 229,  
[233, 234, 238, 240, 242, 253  
betulae, Misocyclops 125  
betulae, Platygaster 125-128,  
[132-134, 136, 137, 139, 140  
betularia, Platygaster 125-128,  
[131-134, 136, 137, 139, 140  
bicinctum, Sceliphron deforme  
[249  
bicinctum, Sceliphron rufopictum  
[244, 249, 254  
bilineatum, Sceliphron 228  
bruijnii, Sceliphron 256  
bruijnii, Pelopoeus 256  
bruijnii, Sceliphron 256  
bruijnii, Sceliphron formosum  
[251, 254, 256, 257, 259  
bruyinii, Sceliphron 256  
Chalybion 219, 221  
coromandelicus, Pelopoeus 243  
coromandelicus, Sceliphron  
[218-220, 222, 224, 239, 243, 252  
curvatus, Pelopoeus 228, 230  
curvatus, Sceliphron 218-221,  
[224, 227, 228, 230, 234,  
[238, 252, 256  
deforme, Sceliphron 218-221,  
[224, 229-231, 234, 236,  
[238, 240, 242, 243, 253  
deforme atripes, Sceliphron 229,  
[233, 234, 238, 240, 242, 253  
deforme bicinctum, Sceliphron  
[249  
deforme deforme, Sceliphron  
[231, 232, 234, 236,  
[238, 240, 249, 253
- \*deforme femorale, Sceliphron  
[217, 229, 231, 234,  
[236, 240, 243, 253  
deforme japonicum, Sceliphron  
[240  
deforme koreanum, Sceliphron  
[240  
deforme nipponicum,  
Sceliphron 233, 234, 240, 253  
deforme rufopictum, Sceliphron  
[249  
deforme taiwanum, Sceliphron  
[238  
deforme tibiale, Sceliphron 231,  
[234, 236, 238, 243, 253  
deforme unifasciatum,  
Sceliphron 254  
deformis, Pelopoeus 236  
deformis, Sceliphron 252  
fallax, Sceliphron 256  
\*femorale, Sceliphron deforme  
[217, 229, 231, 234,  
[236, 240, 243, 253  
fervens, Pelopoeus, 242  
fervens, Sceliphron 219-221, 224,  
[230, 235, 237, 242, 243, 255  
fervens murarium, Sceliphron  
[254  
flavo-fasciatus, Pelopoeus 249,  
[251  
formosum, Sceliphron 218-220,  
[224, 234, 243, 251, 256-258  
formosum bruijnii, Sceliphron  
[251, 254, 256, 257, 259  
formosum formosum, Sceliphron  
[245, 251, 256-258  
formosum koreanum, Sceliphron  
[240  
formosum ocellare, Sceliphron  
[248, 251, 256-258  
formosus, Pelopoeus 258  
formosus, Sceliphron 258  
funestum, Sceliphron 219, 220,  
[223-226, 228, 243, 251  
hiemalis, Platygaster 136  
japonicum, Sceliphron deforme  
[240  
\*kalshoveni, Sceliphron  
rufopictum 217, 219, 220, 224,  
[241, 244, 249, 255  
koreanum, Sceliphron deforme  
[240  
koreanum, Sceliphron formosum  
[240  
\*laticinctum, Sceliphron  
rufopictum 217, 218, 241, 245,  
248, 249, 252, 253, 255
- lineatipes, Sceliphron 234, 236  
mamertes, Piestopleura 126  
Metaclisis 129, 130, 132, 135,  
[138, 140  
Misocyclops 125  
mocsaryi, Sceliphron 254  
murarium, Sceliphron 219, 220,  
[224, 246, 254, 255  
murarium, Sceliphron fervens  
[254  
murarius, Pelopoeus 254  
nipponicum, Sceliphron deforme  
[233, 234, 240, 253  
ocellare, Sceliphron 258  
ocellare, Sceliphron formosum  
[248, 251, 256-258  
papuanum, Sceliphron 258  
Pelopoeus 224, 258  
phragmitis, Metaclisis 125-127,  
[130, 131, 133, 136, 137, 139, 140  
Piestopleura 129, 136  
Platygaster 125, 127-130, 132,  
[133, 135-140  
Prosceliphron 217-222, 224, 225,  
[228, 230, 235, 238, 240, 242,  
[243, 249, 254, 256, 258  
pulchellum, Sceliphron 228  
pulchellum, Sceliphron rectum  
[228, 251  
rectum, Sceliphron 218-220,  
[223-226, 228, 243  
rectum pulchellum, Sceliphron  
[228, 251  
rectum rectum, Sceliphron 228,  
[251  
rufipes, Pelopoeus 254  
rufipes, Sceliphron 254  
rufopictum, Sceliphron 241, 243,  
[244, 247, 249, 254, 255  
rufipictum, Sceliphron deforme  
[249  
rufopictum bicinctum, Sceliphron  
[244, 249, 254  
\*rufopictum kalshoveni,  
Sceliphron 217, 219, 220, 224,  
[241, 244, 249, 255  
\*rufopictum laticinctum  
Sceliphron 217, 218, 241, 245,  
[248, 249, 252, 253, 255  
rufopictum rufopictum,  
Sceliphron 241, 249, 253-255  
rufopictus, Pelopoeus 249  
rufopictus 238  
Sceliphron 217-221, 226  
shestakovi, Sceliphron 219-224,  
[251



- taiwanum, Sceliphron deforme [238  
 tibiale, Sceliphron 234, 236  
 tibiale, Sceliphron deforme 231,  
 [234, 236, 238, 243, 253  
 unifasciatum, Sceliphron 219,  
 [220, 224, 244, 246, 254, 255  
 unifasciatum, Sceliphron  
 deforme 254  
 unifasciatus, Pelopoeus 254
- LEPIDOPTERA**  
 farinalis, Pyralis 17  
 neustria, Malacosoma 17  
 tabaniformis, Paranthrene 17
- ODONATA**  
 Aeshna 68  
 aluensis, Teinobasis 263, 265,  
 [278-281, 286-288  
 Amphicnemis 280  
 Anax 61, 64  
 Archibasis 280  
 bradleyi, Teinobasis 265, 278,  
 [283-285, 288  
 cancellatum, Orthetrum 103  
 \*chionopleura, Teinobasis 263,  
 [265, 278, 283-285, 286  
 Coelicia 274  
 cyanea, Aeshna 36, 59, 64, 70, 97,  
 [100, 103, 115  
 Davidius 115  
 emarginata, Teinobasis 263,  
 [279-282  
 ephippiger, Hemianax 64  
 Epiophlebia, 36, 39, 42, 44, 56,  
 [61, 101, 109, 115, 118, 119  
 erythro stigma, Paramecognemnis  
 [264  
 filicornis, Torrenticnemnis 264  
 frequens, Sympetrum 92  
 \*gerdae, Salomocnemnis 263, 265,  
 [269, 277
- Gomphus 115  
 grandis, Aeshna 109  
 gurneyi, Papuagrion 263, 278,  
 [280  
 gurneyi, Teinobasis 279, 281,  
 [282, 287  
 Hemianax 64  
 Ictinogomphus 115  
 Idiocnemnis 266  
 \*imitans, Teinobasis 263, 265,  
 [278-282, 286, 288  
 imperator, Anax 62-64, 66, 68,  
 [69, 72, 103, 109  
 inornata, Idiocnemnis, 275  
 \*isabellae, Lief tinckia 263, 265,  
 [273, 274, 279  
 juncea, Aeshna 98  
 kimminsi, Lief tinckia 265, 274,  
 [275, 277, 278  
 lairdi, Lief tinckia 265, 271-275,  
 [278  
 Lief tinckia, 265, 268, 271, 273,  
 [279  
 malacodora, Lochmaecognemnis  
 [264  
 \*malaitae, Lief tinckia 263, 265,  
 [272, 273  
 mirabilis, Hemiphlebia 110  
 mixta, Aeshna 36  
 Nesobasis 280  
 obliterated, Idiocnemnis 264  
 \*obtusilingua, Teinobasis 263,  
 [265, 278, 283, 284, 288  
 Oligoneuriella 88  
 Onychogomphus 115  
 Papuagrion 278-280  
 papuensis, Hemianax 64  
 Paramecognemnis 266  
 Pericnemnis 280  
 Procordulia 263  
 \*prothoracica, Rhyacocnemnis 263,  
 [265-267  
 puella, Coenagrion 64
- Pseudagrion 280  
 \*ramosa, Lief tinckia 263, 265, 274,  
 [275, 276, 279  
 Rhyacocnemnis 265  
 rufithorax, Teinobasis 278  
 \*Salomocnemnis 263, 265, 268  
 salomonis, Lief tinckia 265, 268,  
 [269, 271, 272, 277, 278  
 Seychellibasis 278  
 \*simulans, Teinobasis 263, 265,  
 [278-282, 286, 287  
 stictica, Pericnemnis 280  
 striolatum, Sympetrum 101  
 sufficiens, Rhyacocnemnis 265-268  
 superstes, Epiophlebia 117  
 Teinobasis 263, 265, 278-281,  
 [284, 286, 287  
 Torrenticnemnis 263
- ORTHOPTERA**  
 Locusta 77, 97, 98, 104  
 Schistocerca 92, 104, 114
- MOLLUSCA**  
 elegans, Succinea 21
- PLANTAE**  
 Betula 125, 135  
 Betula populifolia 135  
 Casuarina 275, 283  
 Corylus avellana 198  
 Cyclops 202  
 Eucalyptus 195  
 Eucalyptus camaldulensis 195  
 Hedera himalaica 214  
 Pistacia 198, 199  
 Platanus acerifolia 201  
 Quercus agrifolia 202  
 Salvadora oleoides 202  
 Tamarix aphylla 201





























SMITHSONIAN INSTITUTION LIBRARIES



3 9088 00908 9343